

Small Signal Schottky Barrier Diodes

Features

- Integrated protection ring against static discharge
- Low capacitance
- Low leakage current
- Low forward voltage drop
- Very low switching time

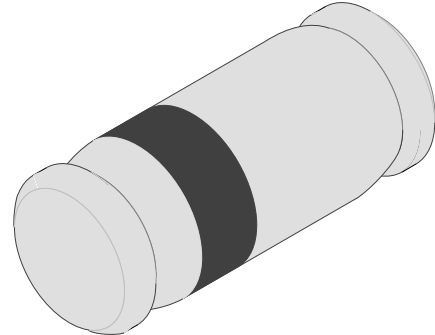

94 9371

Applications

HF-Detector
Protection circuit
Diode for low currents with a low supply voltage
Small battery charger
Power supplies
DC / DC converter for notebooks

Order Instruction

Type	Type Differentiation	Ordering Code	Remarks
BAS81	$V_R = 40\text{ V}$	BAS81-GS08	Tape and Reel
BAS82	$V_R = 50\text{ V}$	BAS82-GS08	Tape and Reel
BAS83	$V_R = 60\text{ V}$	BAS83-GS08	Tape and Reel

Absolute Maximum Ratings

$T_j = 25^\circ\text{C}$

Parameter	Test Conditions	Type	Symbol	Value	Unit
Reverse voltage		BAS81	V_R	40	V
		BAS82	V_R	50	V
		BAS83	V_R	60	V
Peak forward surge current	$t_p=1\text{ s}$		I_{FSM}	500	mA
Repetitive peak forward current			I_{FRM}	150	mA
Forward current			I_F	30	mA
Junction temperature			T_j	125	$^\circ\text{C}$
Storage temperature range			T_{stg}	-65...+150	$^\circ\text{C}$

Maximum Thermal Resistance

$T_j = 25^\circ\text{C}$

Parameter	Test Conditions	Symbol	Value	Unit
Junction ambient	on PC board 50 mmx50 mmx1.6 mm	R_{thJA}	320	K/W

Electrical Characteristics

$T_j = 25^\circ\text{C}$

Parameter	Test Conditions	Type	Symbol	Min	Typ	Max	Unit
Forward voltage	$I_F=0.1\text{mA}$		V_F			330	mV
	$I_F=1\text{mA}$		V_F			410	mV
	$I_F=15\text{mA}$		V_F			1	V
Reverse current	$V_R=V_{R\text{max}}$		I_R			200	nA
Diode capacitance	$V_R=1\text{V}, f=1\text{MHz}$		C_D			1.6	pF

Characteristics ($T_j = 25^\circ\text{C}$ unless otherwise specified)

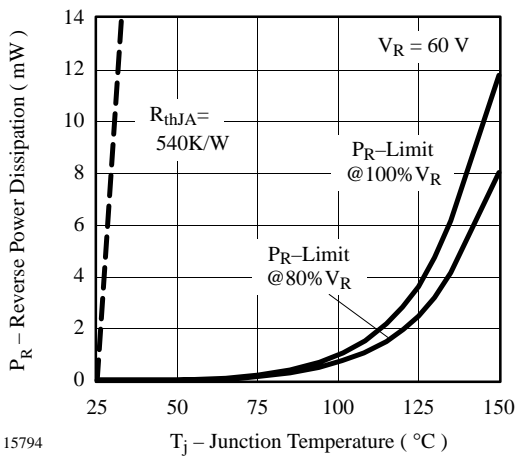

Figure 1. Max. Reverse Power Dissipation vs. Junction Temperature

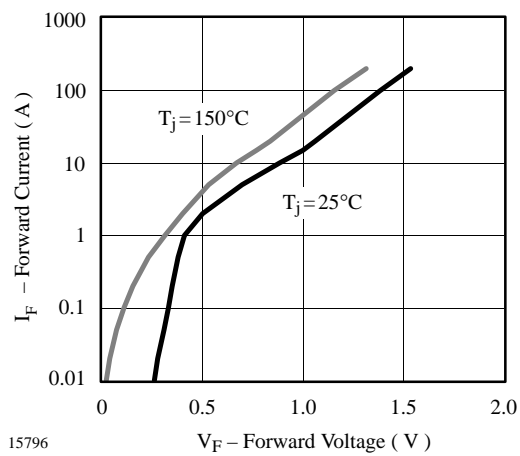

Figure 3. Forward Current vs. Forward Voltage

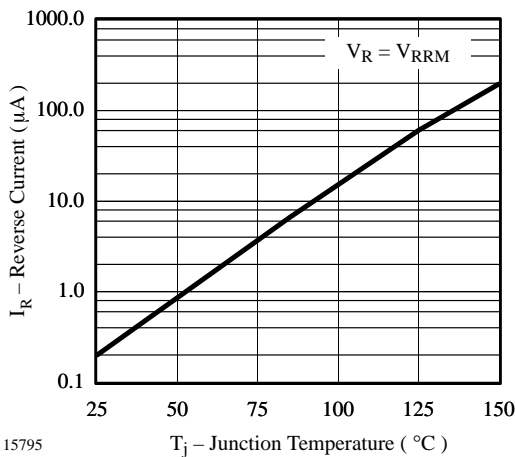

Figure 2. Reverse Current vs. Junction Temperature

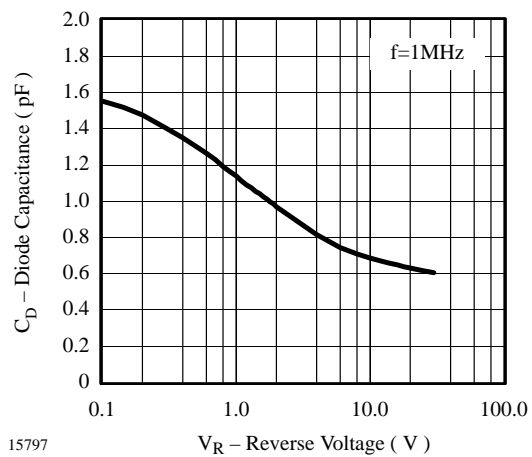
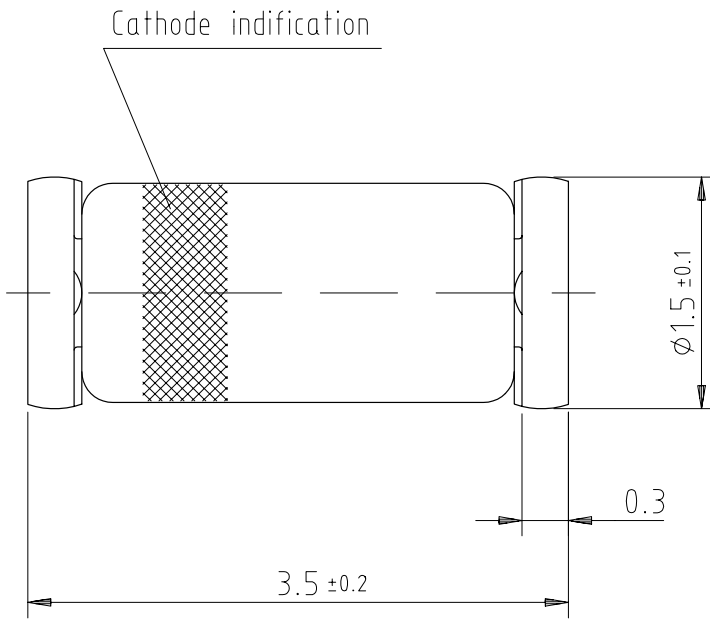
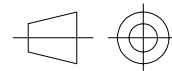
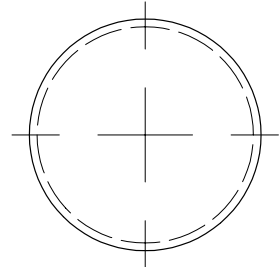

Figure 4. Diode Capacitance vs. Reverse Voltage

Dimensions in mm



Glass case
Mini MELF / SOD 80
JEDEC DO 213 AA



technical drawings
according to DIN
specifications

96 12070

Ozone Depleting Substances Policy Statement

It is the policy of **Vishay Semiconductor GmbH** to

1. Meet all present and future national and international statutory requirements.
2. Regularly and continuously improve the performance of our products, processes, distribution and operating systems with respect to their impact on the health and safety of our employees and the public, as well as their impact on the environment.

It is particular concern to control or eliminate releases of those substances into the atmosphere which are known as ozone depleting substances (ODSs).

The Montreal Protocol (1987) and its London Amendments (1990) intend to severely restrict the use of ODSs and forbid their use within the next ten years. Various national and international initiatives are pressing for an earlier ban on these substances.

Vishay Semiconductor GmbH has been able to use its policy of continuous improvements to eliminate the use of ODSs listed in the following documents.

1. Annex A, B and list of transitional substances of the Montreal Protocol and the London Amendments respectively
2. Class I and II ozone depleting substances in the Clean Air Act Amendments of 1990 by the Environmental Protection Agency (EPA) in the USA
3. Council Decision 88/540/EEC and 91/690/EEC Annex A, B and C (transitional substances) respectively.

Vishay Semiconductor GmbH can certify that our semiconductors are not manufactured with ozone depleting substances and do not contain such substances.

We reserve the right to make changes to improve technical design and may do so without further notice.

Parameters can vary in different applications. All operating parameters must be validated for each customer application by the customer. Should the buyer use Vishay Semiconductors products for any unintended or unauthorized application, the buyer shall indemnify Vishay Semiconductors against all claims, costs, damages, and expenses, arising out of, directly or indirectly, any claim of personal damage, injury or death associated with such unintended or unauthorized use.

Vishay Semiconductor GmbH, P.O.B. 3535, D-74025 Heilbronn, Germany
Telephone: 49 (0)7131 67 2831, Fax number: 49 (0)7131 67 2423