

## Ultra Fast Avalanche SMD Rectifier

### Features

- Controlled avalanche characteristic
- Glass passivated junction
- Low reverse current
- Low forward voltage
- Soft recovery characteristic
- Very fast reverse recovery time
- Good switching characteristics
- Wave and reflow solderable

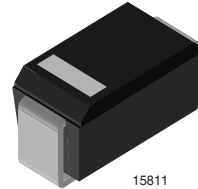

### Applications

Surface mounting  
 Super fast rectifier  
 Freewheeling diodes in SMPS and converters  
 Snubber diodes

### Parts Table

| Part   | Type differentiation                           | Package  |
|--------|--|----------|
| BYG22A | $V_R = 50 \text{ V @ } I_{FAV} = 2 \text{ A}$  | DO-214AC |
| BYG22B | $V_R = 100 \text{ V @ } I_{FAV} = 2 \text{ A}$ | DO-214AC |
| BYG22D | $V_R = 200 \text{ V @ } I_{FAV} = 2 \text{ A}$ | DO-214AC |

### Absolute Maximum Ratings

$T_{amb} = 25 \text{ }^\circ\text{C}$ , unless otherwise specified

| Parameter  | Test condition  | Part   | Symbol          | Value         | Unit             |
|--|---|--------|-----------------|---------------|------------------|
| Reverse voltage = Repetitive peak reverse voltage                          |   | BYG22A | $V_R = V_{RRM}$ | 50            | V                |
|  |   | BYG22B | $V_R = V_{RRM}$ | 100           | V                |
|  |   | BYG22D |                 | 200           | V                |
| Peak forward surge current   | $t_p = 10 \text{ ms}$ , half sinewave                         |        | $I_{FSM}$       | 35            | A                |
| Average forward current  |   |        | $I_{FAV}$       | 2             | A                |
| Junction and storage temperature range                                     |   |        | $T_j = T_{stg}$ | - 55 to + 150 | $^\circ\text{C}$ |
| Pulse energy in avalanche mode, non repetitive (inductive load switch off) | $I_{(BR)R} = 1 \text{ A}$ , $T_j = 25 \text{ }^\circ\text{C}$ |        | $E_R$           | 20            | mJ               |

### Maximum Thermal Resistance

$T_{amb} = 25\text{ }^{\circ}\text{C}$ , unless otherwise specified

| Parameter        | Test condition  | Part | Symbol     | Value | Unit |
|------------------|---|------|------------|-------|------|
| Junction lead    | $T_L = \text{const.}$   |      | $R_{thJL}$ | 25    | K/W  |
| Junction ambient | mounted on epoxy-glass hard tissue  |      | $R_{thJA}$ | 150   | K/W  |
|                  | mounted on epoxy-glass hard tissue, 50 mm <sup>2</sup> 35 μm Cu                           |      | $R_{thJA}$ | 125   | K/W  |
|                  | mounted on Al-oxid-ceramic (Al <sub>2</sub> O <sub>3</sub> ), 50 mm <sup>2</sup> 35 μm Cu |      | $R_{thJA}$ | 100   | K/W  |

### Electrical Characteristics

$T_{amb} = 25\text{ }^{\circ}\text{C}$ , unless otherwise specified

| Parameter             | Test condition  | Part | Symbol   | Min | Typ. | Max | Unit |
|-----------------------|---|------|----------|-----|------|-----|------|
| Forward voltage       | $I_F = 1\text{ A}$  |      | $V_F$    |     |      | 1   | V    |
|                       | $I_F = 2\text{ A}$  |      | $V_F$    |     |      | 1.1 | V    |
| Reverse current       | $V_R = V_{RRM}$   |      | $I_R$    |     |      | 1   | μA   |
|                       | $V_R = V_{RRM}, T_j = 100\text{ }^{\circ}\text{C}$          |      | $I_R$    |     |      | 10  | μA   |
| Reverse recovery time | $I_F = 0.5\text{ A}, I_R = 1\text{ A}, i_R = 0.25\text{ A}$ |      | $t_{rr}$ |     |      | 25  | ns   |

### Typical Characteristics ( $T_{amb} = 25\text{ }^{\circ}\text{C}$ unless otherwise specified)

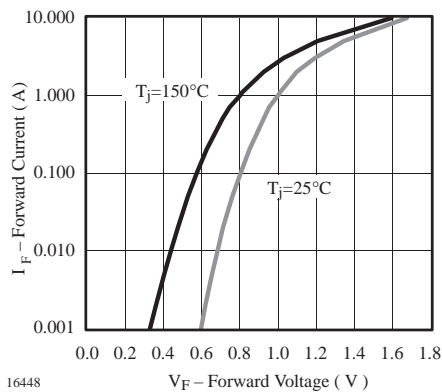

Figure 1. Forward Current vs. Forward Voltage

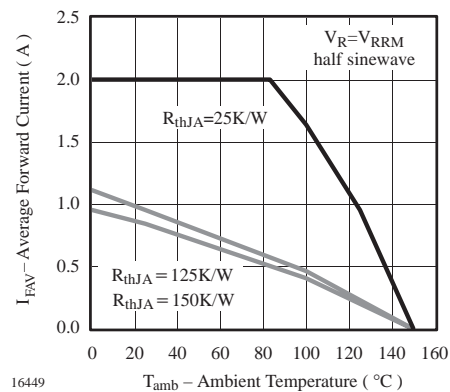

Figure 2. Max. Average Forward Current vs. Ambient Temperature

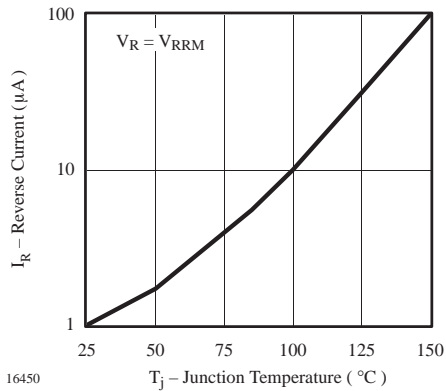

Figure 3. Reverse Current vs. Junction Temperature

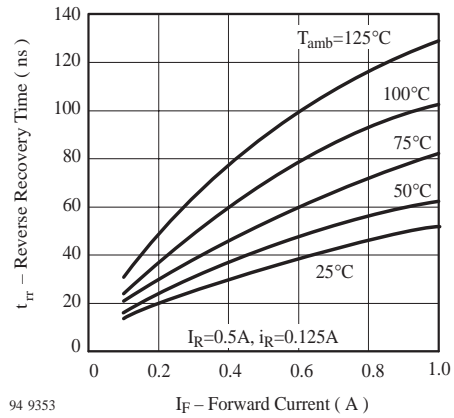

Figure 6. Max. Reverse Recovery Time vs. Forward Current

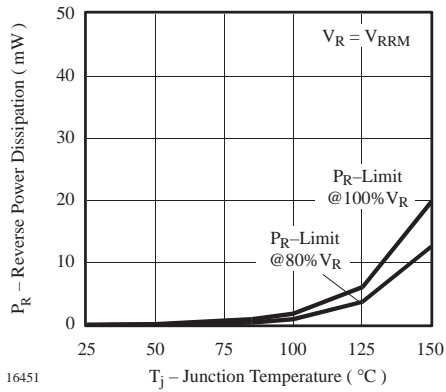

Figure 4. Max. Reverse Power Dissipation vs. Junction Temperature

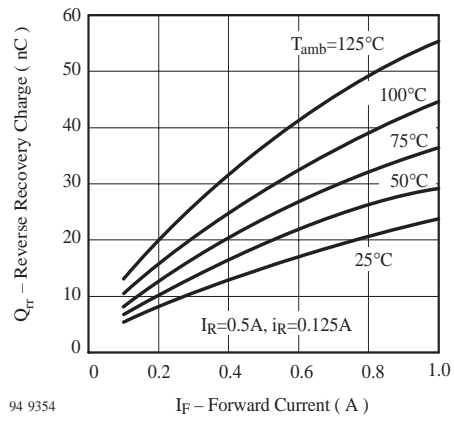

Figure 7. Max. Reverse Recovery Charge vs. Forward Current

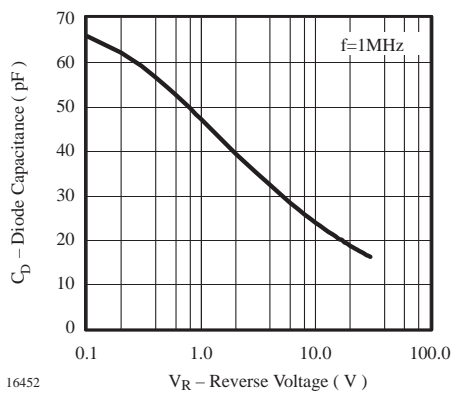

Figure 5. Diode Capacitance vs. Reverse Voltage

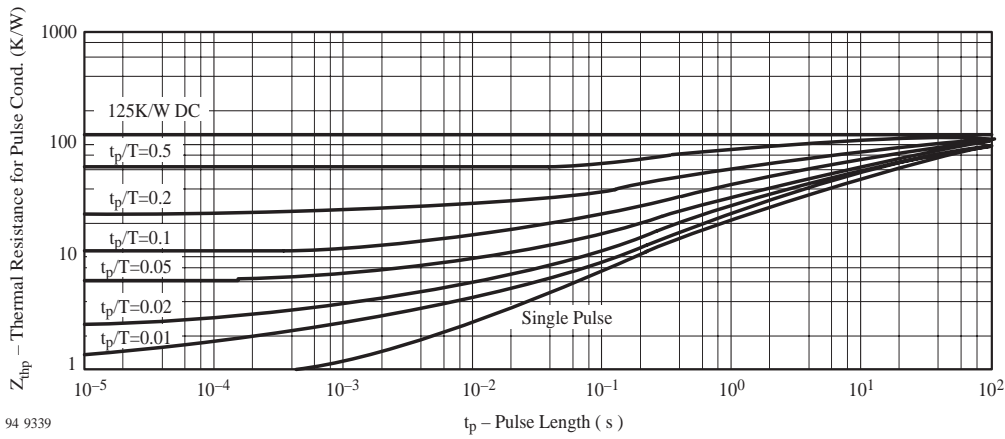
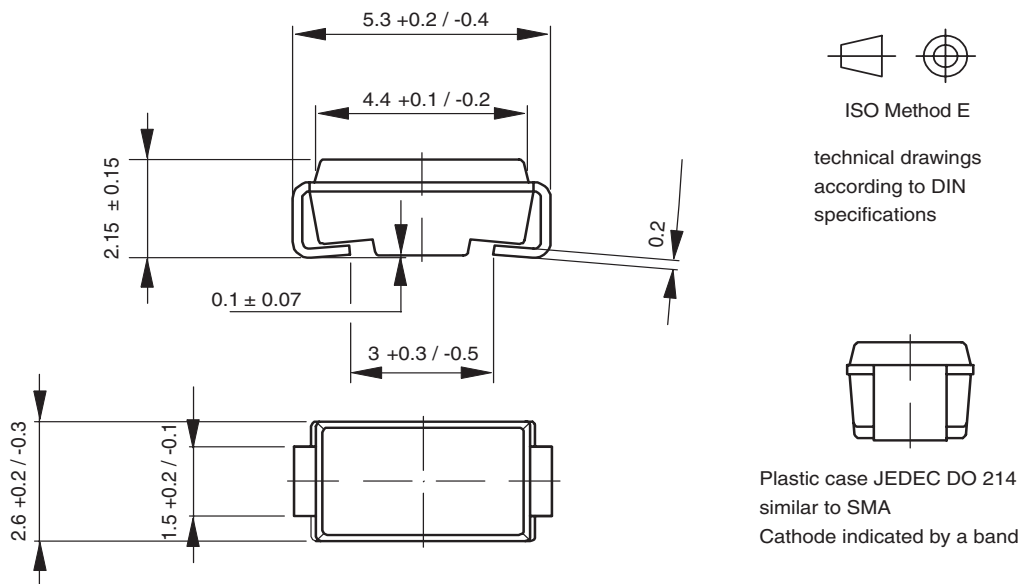

Figure 8. Thermal Response

## Package Dimensions in mm (Inches)



14275-1