

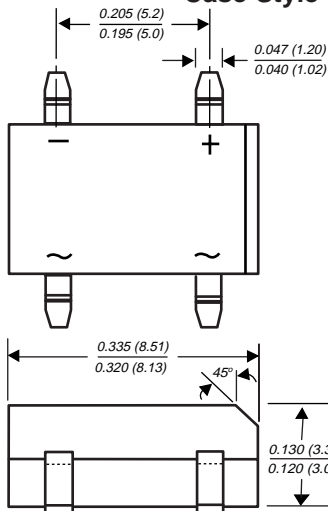

Miniature Glass Passivated Ultrafast Surface Mount Bridge Rectifiers

Reverse Voltage 50 to 200V
Forward Current 1.0A

Case Style DFS



Dimensions in inches and (millimeters)

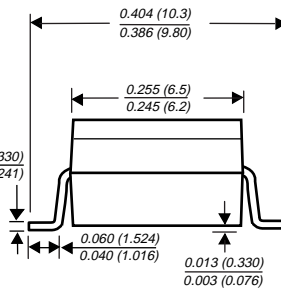

Mounting Pad Layout

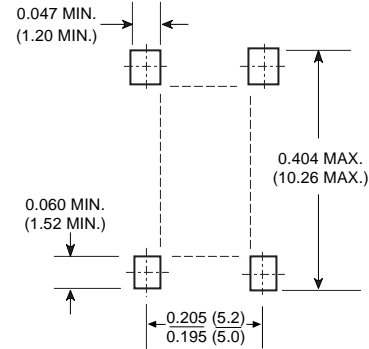

Mechanical Data

- Case:** Molded plastic body over passivated junctions
- Terminals:** Plated leads solderable per MIL-STD-750, Method 2026
- Polarity:** Polarity symbols marked on body
- Mounting Position:** Any
- Weight:** 0.014 oz., 0.4 g
- Packaging codes/options:**
 - 27/1.5K per 13" Reel (16mm Tape)
 - 45/50 ea. per Tube-Bulk

Features

- Plastic package has Underwriters Laboratory Flammability Classification 94V-0
- This series is UL listed under Recognized Component Index, file number E54214
- Glass passivated chip junctions
- High surge overload rating-50 amperes peak
- Ideal for printed circuit boards
- Superfast recovery times for high efficiency
- High temperature soldering guaranteed: 260°C/10 seconds at 5 lbs. (2.3kg) tension

Maximum Ratings and Thermal Characteristics (T_A = 25°C unless otherwise noted)

Parameter	Symbol	EDF1AS	EDF1BS	EDF1CS	EDF1DS	Unit
Maximum repetitive peak reverse voltage	V _{RRM}	50	100	150	200	V
Maximum RMS voltage	V _{RMS}	35	70	106	140	V
Maximum DC blocking voltage	V _{DC}	50	100	150	200	V
Maximum average forward output rectified current at T _A = 40°C (Note 2)	I _{F(AV)}	1.0				A
Peak forward surge current single half sine-wave superimposed on rated load (JEDEC Method) T _J = 150°C	I _{FSM}	50				A
Rating for fusing (t < 8.3ms)	I ² t	10				A ² sec
Typical thermal resistance per leg (Note 1)	R _{θJA} R _{θJL}	38 12				°C/W
Operating junction and storage temperature range	T _J , T _{STG}	55 to +150				°C

Electrical Characteristics (T_A = 25°C unless otherwise noted)

Max. instantaneous forward voltage drop per leg at 1.0A (Note 2)	V _F	1.05				V
Maximum DC reverse current at rated DC blocking voltage	I _R	5.0 1.0				μA mA
Max. reverse recovery time at I _F = 0.5A, I _R = 1.0A, I _{rr} = 0.25A	t _{rr}	50				ns

Notes: (1) P.C.B. mounted with 0.2 x 0.2" (5.0 x 5.0mm) copper pad areas
(2) Pulse test: 300μs pulse width, 1% duty cycle

Ratings and Characteristic Curves ($T_A = 25^\circ\text{C}$ unless otherwise noted)

Fig. 1 - Derating Curves Output Rectified Current

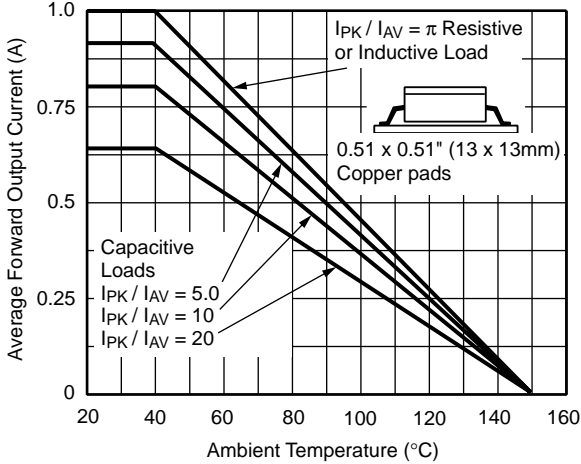

Fig. 2 - Maximum Non-Repetitive Peak Forward Surge Current

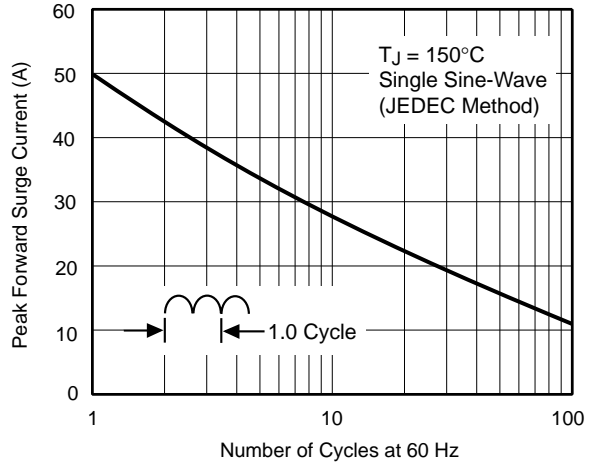

Fig. 3 - Typical Forward Characteristics Per Leg

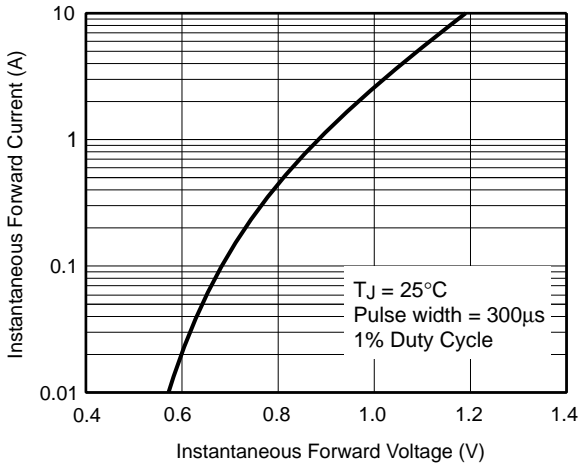

Fig. 4 - Typical Reverse Leakage Characteristics Per Leg

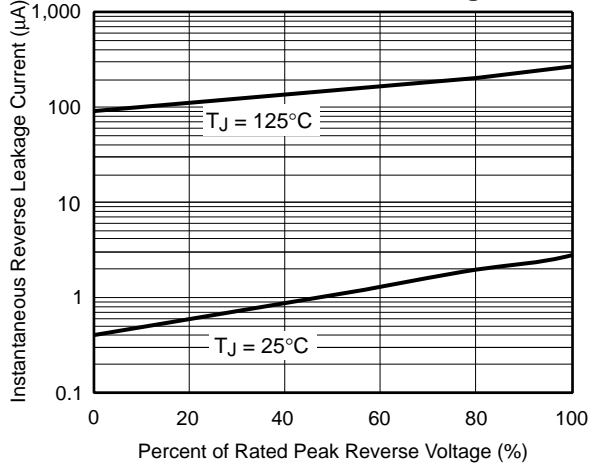

Fig. 5 - Typical Junction Capacitance Per Leg

