

Glass Passivated Single-Phase Bridge Rectifier

Major Ratings and Characteristics

$I_{F(AV)}$	12 A, 15 A, 25 A, 35 A
V_{RRM}	50 V to 1000 V
I_{FSM}	200 A, 300 A, 300 A, 400 A
I_R	5 μ A
V_F	1.1 V
T_j max.	150 °C

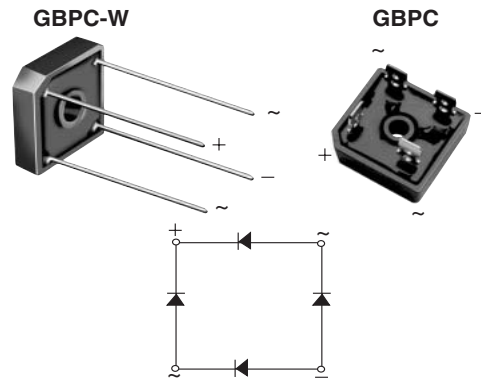

Features

- UL Recognition file number E54214
- Universal 3-way terminals: snap-on, wire wrap-around, or P.C.B. mounting
- Typical I_R less than 0.3 μ A
- High surge current capability
- Low thermal resistance
- Meets MSL level 1, per J-STD-020C

Typical Applications

General purpose use in ac-to-dc bridge full wave rectification for Power Supply, Home Appliances, Office Equipment, Industrial Automation applications

Mechanical Data

Case: GBPC, GBPC-W

Epoxy meets UL-94V-0 Flammability rating

Terminals: Nickel plated on faston lugs or Silver plated on wire leads (E4 Suffix), solderable per J-STD-002B and MIL-STD-750, Method 2026. Suffix letter "W" added to indicate wire leads (e.g. GBPC12005W)

Polarity: As marked, Positive lead by beveled corner

Mounting Torque: 20 inches-lbs. max.

Maximum Ratings

Ratings at 25 °C ambient temperature unless otherwise specified.

Parameter	Symbols	GBPC12, 15, 25, 35							Units
		005	01	02	04	06	08	10	
Maximum repetitive peak reverse voltage	V_{RRM}	50	100	200	400	600	800	1000	V
Maximum RMS voltage	V_{RMS}	35	70	140	280	420	560	700	V
Maximum DC blocking voltage	V_{DC}	50	100	200	400	600	800	1000	V
Maximum average forward rectified output current (See Fig.1)	$I_{F(AV)}$	GBPC12: 12 GBPC15: 15 GBPC25: 25 GBPC35: 35							A
Peak forward surge current single sine-wave superimposed on rated load	I_{FSM}	GBPC12: 200 GBPC15: 300 GBPC25: 300 GBPC35: 400							A
Rating (non-repetitive, for t greater than 1 ms and less than 8.3 ms) for fusing	I^2t	GBPC12: 160 GBPC15: 375 GBPC25: 375 GBPC35: 660							A ² sec
RMS isolation voltage from case to leads	V_{ISO}	2500							V
Operating junction storage temperature range	T_J, T_{STG}	- 55 to + 150							°C

Electrical Characteristics

Ratings at 25 °C ambient temperature unless otherwise specified.

Parameter	Test condition	Symbols	GBPC12, 15, 25, 35						Units	
			005	01	02	04	06	08		10
Maximum instantaneous forward drop per leg	GBPC12 GBPC15 GBPC25 GBPC35	$I_F = 6.0\text{ A}$ $I_F = 7.5\text{ A}$ $I_F = 12.5\text{ A}$ $I_F = 17.5\text{ A}$	V_F	1.1						V
Maximum reverse DC current at rated DC blocking voltage per leg	$T_A = 25\text{ °C}$ $T_A = 125\text{ °C}$	I_R	5.0 500						μA	
Typical junction capacitance per leg	at 4 V, 1 MHz	C_J	300						pF	

Thermal Characteristics

Ratings at 25 °C ambient temperature unless otherwise specified.

Parameter	Symbols	GBPC12, 15, 25, 35						Units	
		005	01	02	04	06	08		10
Typical thermal resistance per leg ⁽¹⁾	GBPC12-25 GBPC35	$R_{\theta JC}$	1.9 1.4						$^{\circ}\text{C/W}$

Notes:

- (1) Thermal resistance from junction to case per leg
- (2) Bolt down on heatsink with silicone thermal compound between bridge and mounting surface for maximum heat transfer with #10 screw

Ratings and Characteristics Curves

($T_A = 25\text{ °C}$ unless otherwise noted)

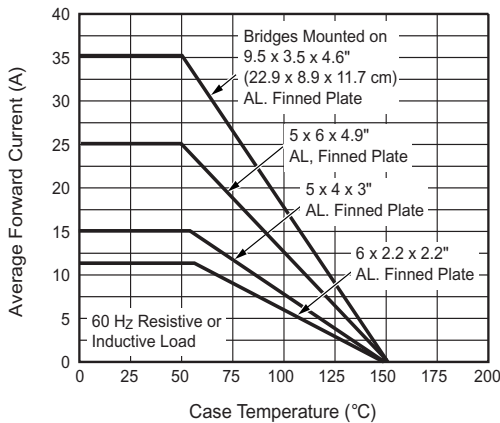

Figure 1. Maximum Output Rectified Current

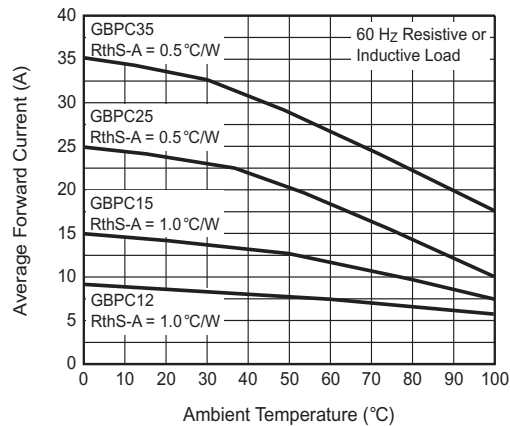

Figure 2. Maximum Output Rectified Current

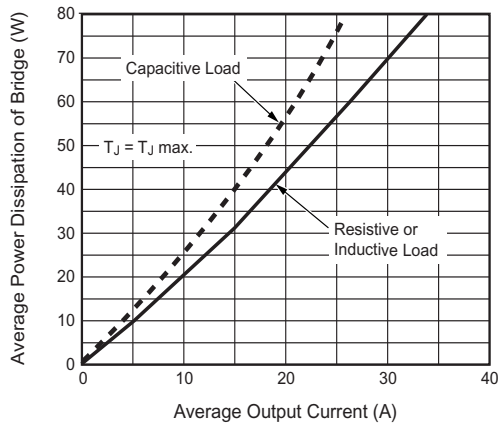

Figure 3. Maximum Power Dissipation

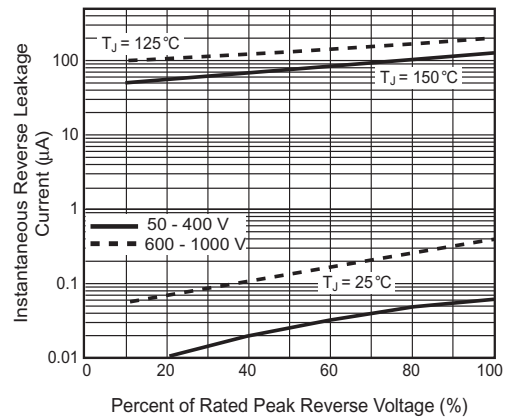

Figure 6. Typical Reverse Leakage Characteristics Per Leg

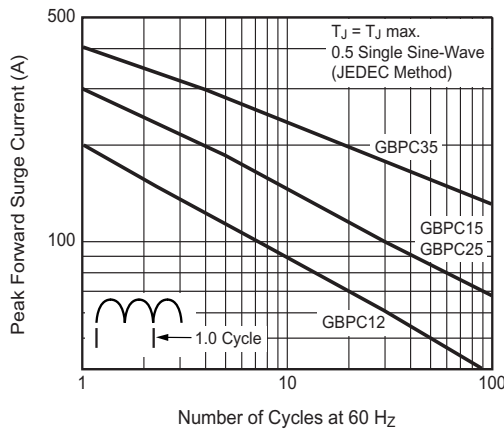

Figure 4. Maximum Non-Repetitive Peak Forward Surge Current Per Leg

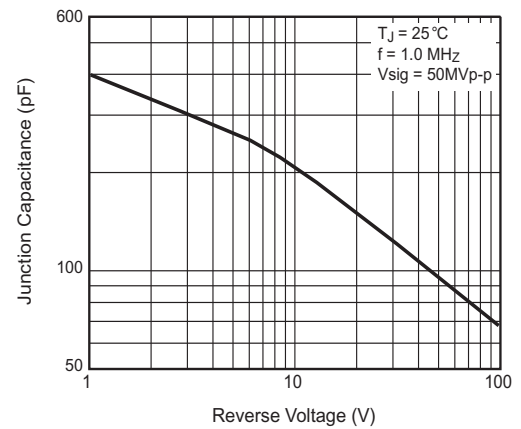

Figure 7. Typical Junction Capacitance Per Leg

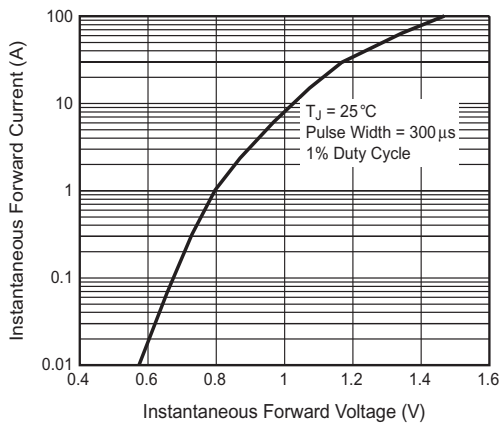

Figure 5. Typical Instantaneous Forward Characteristics Per Leg

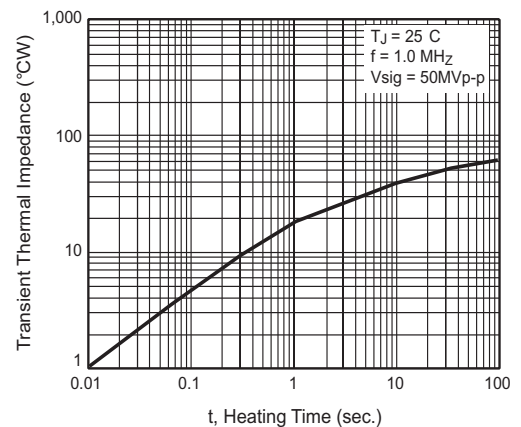

Figure 8. Typical Transient Thermal Impedance Per Leg

GBPC12, 15, 25 and 35



Vishay Semiconductors

Package outline dimensions in inches (millimeters)

