

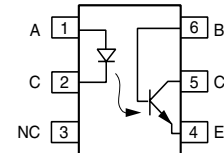

## Optocoupler, Phototransistor Output, With Base Connection

### Features

- Interfaces with common logic families
- Input-output coupling capacitance < 0.5 pF
- Industry Standard Dual-in line 6-pin package
- 5300 V<sub>RMS</sub> isolation test voltage
- Lead-free component
- Component in accordance to RoHS 2002/95/EC and WEEE 2002/96/EC

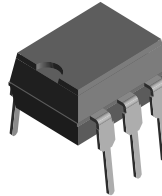

1179004



### Agency Approvals

- UL1577, File No. E52744 System Code H or J, Double Protection
- CSA 93751
- BSI IEC60950 IEC60065
- DIN EN 60747-5-2 (VDE0884)  
DIN EN 60747-5-5 pending  
Available with Option 1
- FIMKO

These isolation processes and the Vishay ISO9001 quality program results in the highest isolation performance available for a commercial plastic phototransistor optocoupler.

The devices are available in lead formed configuration suitable for surface mounting and are available either on tape and reel, or in standard tube shipping containers.

### Applications

- AC mains detection
- Reed relay driving
- Switch mode power supply feedback
- Telephone ring detection
- Logic ground isolation
- Logic coupling with high frequency noise rejection

### Footnotes

Designing with data sheet is covered in Application Note 45.

### Description

The H11Ax family is an Industry Standard Single Channel Phototransistor Coupler. It includes the H11A1/ H11A2/ H11A3/ H11A4/ H11A5 couplers.

Each optocoupler consists of gallium arsenide infrared LED and a silicon NPN phototransistor.

The isolation performance is accomplished through Vishay double molding isolation manufacturing process. Compliance to DIN EN 60747-5-2(VDE0884)/ DIN EN 60747-5-5 pending partial discharge isolation specification is available is by ordering option 1.

### Order Information

Part	Remarks
H11A1	CTR > 50 %, DIP-6
H11A2	CTR > 20 %, DIP-6
H11A3	CTR > 20 %, DIP-6
H11A4	CTR > 10 %, DIP-6
H11A5	CTR > 30 %, DIP-6
H11A1-X006	CTR > 50 %, DIP-6 400 mil (option 6)
H11A1-X007	CTR > 50 %, SMD-6 (option 7)
H11A1-X009	CTR > 50 %, SMD-6 (option 9)

For additional information on the available options refer to Option Information.

### Absolute Maximum Ratings

$T_{amb} = 25\text{ }^{\circ}\text{C}$ , unless otherwise specified

Stresses in excess of the absolute Maximum Ratings can cause permanent damage to the device. Functional operation of the device is not implied at these or any other conditions in excess of those given in the operational sections of this document. Exposure to absolute Maximum Rating for extended periods of the time can adversely affect reliability.

### Input

Parameter	Test condition	Symbol	Value	Unit
Reverse voltage		$V_R$	6.0	V
Forward current		$I_F$	60	mA
Surge current	$t \leq 10\text{ }\mu\text{s}$	$I_{FSM}$	2.5	A
Power dissipation		$P_{diss}$	100	mW

### Output

Parameter	Test condition	Symbol	Value	Unit
Collector-emitter breakdown voltage		$V_{CEO}$	70	V
Emitter-base breakdown voltage		$V_{EBO}$	7.0	V
Collector current		$I_C$	50	mA
	( $t < 1.0\text{ ms}$ )	$I_C$	100	mA
Power dissipation		$P_{diss}$	150	mW

### Coupler

Parameter	Test condition	Symbol	Value	Unit
Isolation test voltage		$V_{ISO}$	5300	$V_{RMS}$
Creepage			$\geq 7.0$	mm
Clearance			$\geq 7.0$	mm
Isolation thickness between emitter and detector			$\geq 0.4$	mm
Comparative tracking index per DIN IEC 112/VDE0303, part 1			175	
Isolation resistance	$V_{IO} = 500\text{ V}$ , $T_{amb} = 25\text{ }^{\circ}\text{C}$	$R_{IO}$	$10^{12}$	$\Omega$
	$V_{IO} = 500\text{ V}$ , $T_{amb} = 100\text{ }^{\circ}\text{C}$	$R_{IO}$	$10^{11}$	$\Omega$
Storage temperature		$T_{amb}$	- 55 to + 150	$^{\circ}\text{C}$
Operating temperature		$T_{stg}$	- 55 to + 100	$^{\circ}\text{C}$
Junction temperature		$T_j$	100	$^{\circ}\text{C}$
Soldering temperature	max. 10 s dip soldering: distance to seating plane $\geq 1.5\text{ mm}$	$T_{sld}$	260	$^{\circ}\text{C}$



## Electrical Characteristics

$T_{amb} = 25\text{ }^{\circ}\text{C}$ , unless otherwise specified

Minimum and maximum values are testing requirements. Typical values are characteristics of the device and are the result of engineering evaluation. Typical values are for information only and are not part of the testing requirements.

### Input

Parameter	Test condition	Part	Symbol	Min	Typ.	Max	Unit
Forward voltage	$I_F = 10\text{ mA}$	H11A1	$V_F$		1.1	1.5	V
		H11A2	$V_F$		1.1	1.5	V
		H11A3	$V_F$		1.1	1.5	V
		H11A4	$V_F$		1.1	1.5	V
		H11A5	$V_F$		1.1	1.7	V
Reverse current	$V_R = 3.0\text{ V}$		$I_R$			10	$\mu\text{A}$
Capacitance	$V_R = 0, f = 1.0\text{ MHz}$		$C_O$		50		pF

### Output

Parameter	Test condition	Symbol	Min	Typ.	Max	Unit
Collector-emitter breakdown voltage	$I_C = 1.0\text{ mA}, I_F = 0\text{ mA}$	$BV_{CEO}$	30			V
Emitter-collector breakdown voltage	$I_E = 100\text{ }\mu\text{A}, I_F = 0\text{ mA}$	$BV_{ECO}$	7.0			V
Collector-base breakdown voltage	$I_C = 10\text{ }\mu\text{A}, I_F = 0\text{ mA}$	$BV_{CBO}$	70			V
Collector-emitter leakage current	$V_{CE} = 10\text{ V}, I_F = 0\text{ mA}$	$I_{CEO}$		5.0	50	nA
Collector-emitter capacitance	$V_{CE} = 0$	$C_{CE}$		6.0		pF

### Coupler

Parameter	Test condition	Symbol	Min	Typ.	Max	Unit
Saturation voltage, collector-emitter	$I_{CE} = 0.5\text{ mA}, I_F = 10\text{ mA}$	$V_{CEsat}$			0.4	V
Capacitance (input-output)		$C_{IO}$		0.5		pF

### Current Transfer Ratio

Parameter	Test condition	Part	Symbol	Min	Typ.	Max	Unit
DC Current Transfer Ratio	$V_{CE} = 10\text{ V}, I_F = 10\text{ mA}$	H11A1	$CTR_{DC}$	50			%
		H11A2	$CTR_{DC}$	20			%
		H11A3	$CTR_{DC}$	20			%
		H11A4	$CTR_{DC}$	10			%
		H11A5	$CTR_{DC}$	30			%

## Switching Characteristics

Parameter	Test condition	Symbol	Min	Typ.	Max	Unit
Switching time	$I_C = 2 \text{ mA}$ , $R_L = 100 \Omega$ , $V_{CE} = 10 \text{ V}$	$t_{on}$ , $t_{off}$		3.0		$\mu\text{s}$

## Typical Characteristics (Tamb = 25 °C unless otherwise specified)

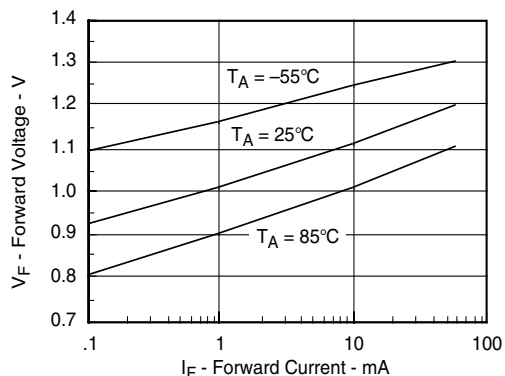

4n25\_01

Figure 1. Forward Voltage vs. Forward Current

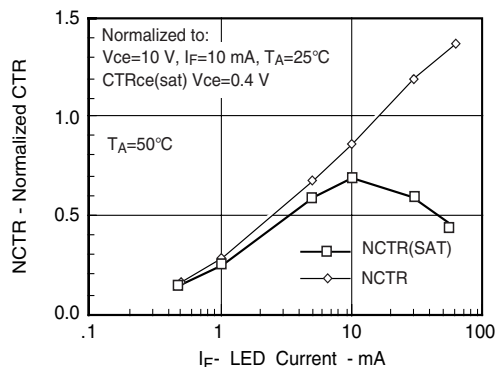

4n25\_03

Figure 3. Normalized Non-saturated and Saturated CTR vs. LED Current

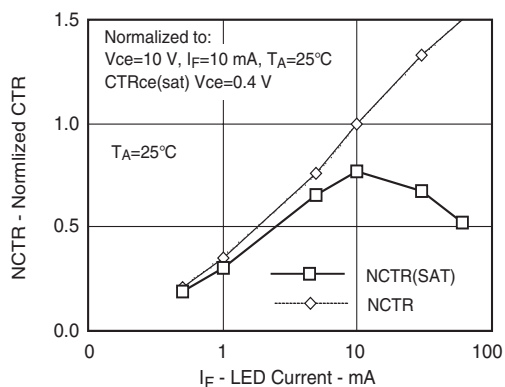

4n25\_02

Figure 2. Normalized Non-saturated and Saturated CTR vs. LED Current

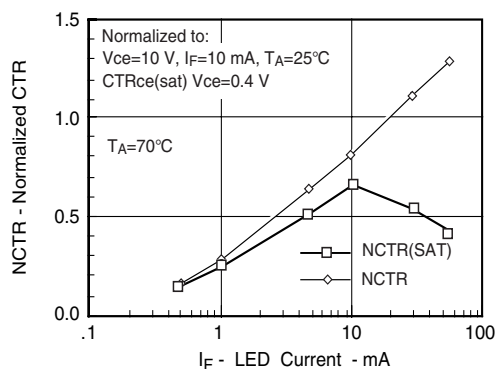

4n25\_04

Figure 4. Normalized Non-saturated and saturated CTR vs. LED Current

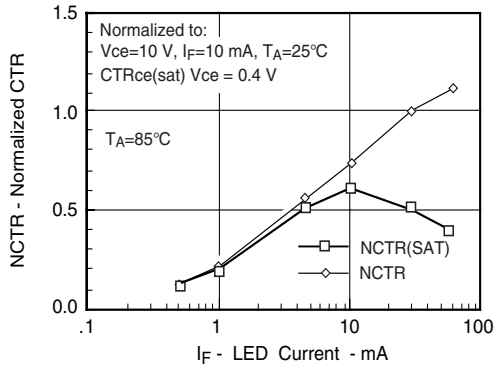

4n25\_05

Figure 5. Normalized Non-saturated and saturated CTR vs. LED Current

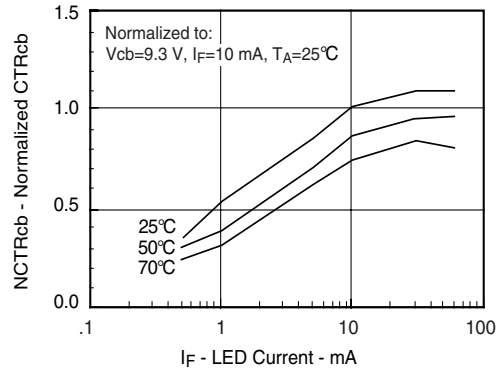

4n25\_08

Figure 8. Normalized CTRcb vs. LED Current and Temp.

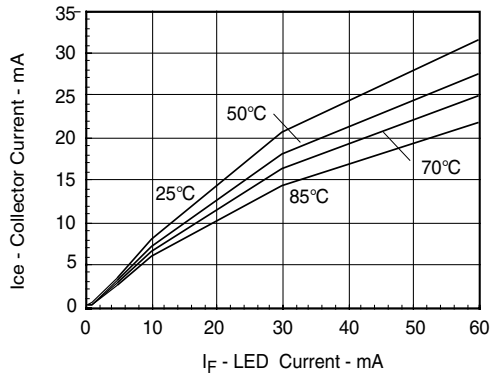

4n25\_06

Figure 6. Collector-Emitter Current vs. Temperature and LED Current

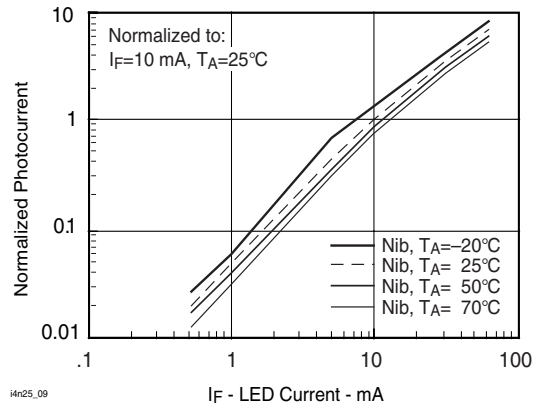

4n25\_09

Figure 9. Normalized Photocurrent vs.  $I_F$  and Temp.

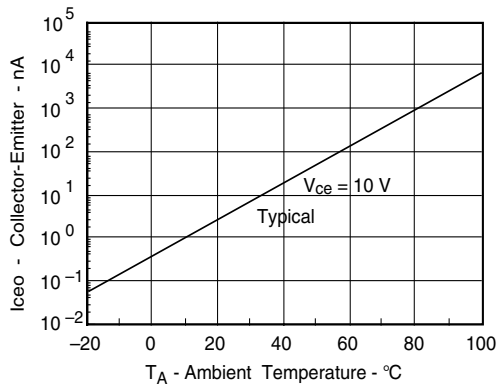

4n25\_07

Figure 7. Collector-Emitter Leakage Current vs. Temp.

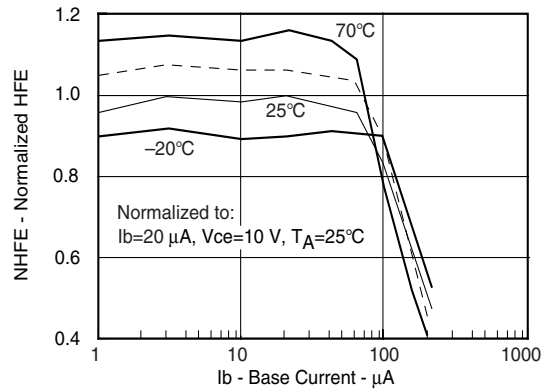

4n25\_10

Figure 10. Normalized Non-saturated HFE vs. Base Current and Temperature

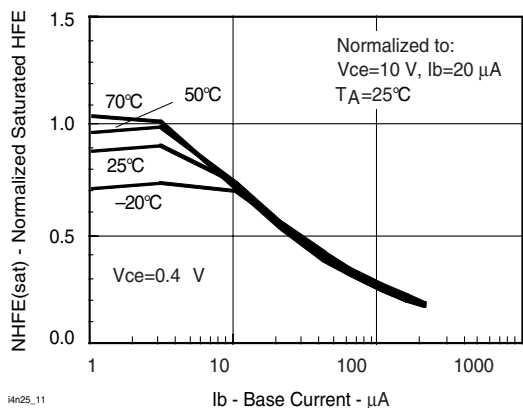

4n25\_11

Figure 11. Normalized HFE vs. Base Current and Temp.

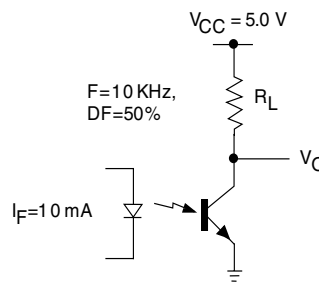

4n25\_14

Figure 14. Switching Schematic

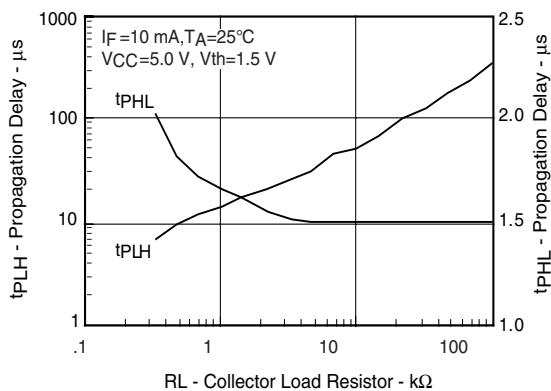

4n25\_12

Figure 12. Propagation Delay vs. Collector Load Resistor

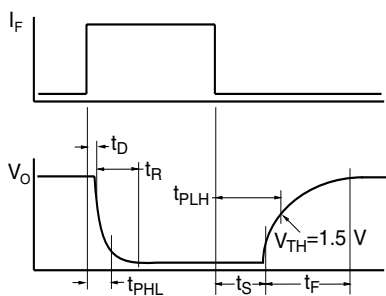

4n25\_13

Figure 13. Switching Timing



# H11A1/ H11A2/ H11A3/ H11A4/ H11A5

Vishay Semiconductors

## Package Dimensions in Inches (mm)

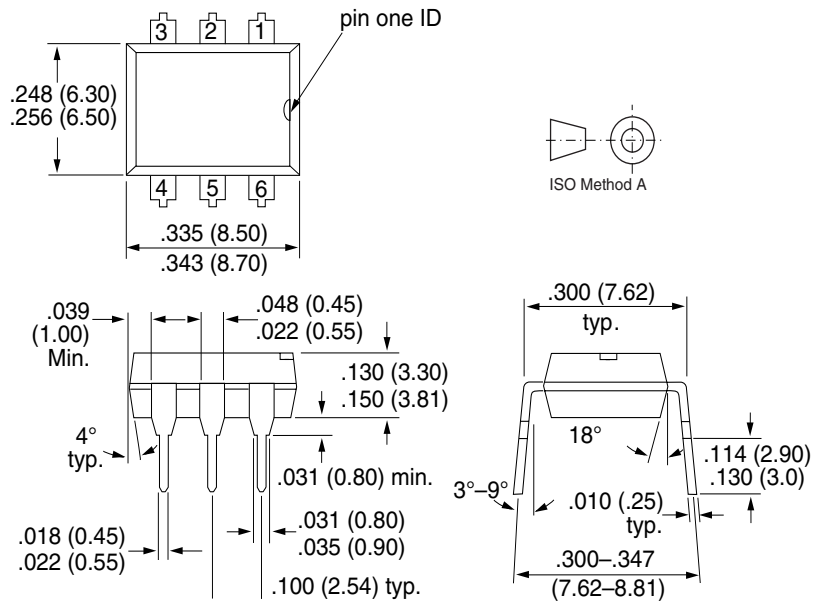

i178004

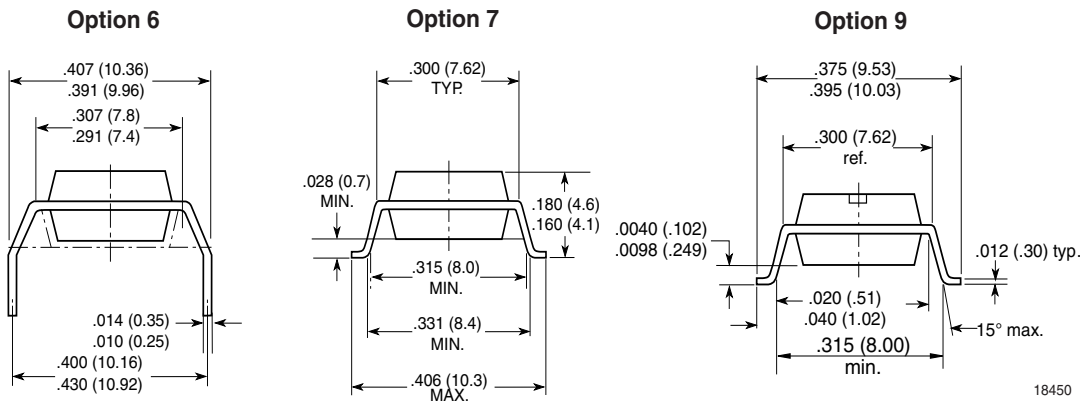

18450

### Ozone Depleting Substances Policy Statement

It is the policy of Vishay Semiconductor GmbH to

1. Meet all present and future national and international statutory requirements.
2. Regularly and continuously improve the performance of our products, processes, distribution and operating systems with respect to their impact on the health and safety of our employees and the public, as well as their impact on the environment.

It is particular concern to control or eliminate releases of those substances into the atmosphere which are known as ozone depleting substances (ODSs).

The Montreal Protocol (1987) and its London Amendments (1990) intend to severely restrict the use of ODSs and forbid their use within the next ten years. Various national and international initiatives are pressing for an earlier ban on these substances.

Vishay Semiconductor GmbH has been able to use its policy of continuous improvements to eliminate the use of ODSs listed in the following documents.

1. Annex A, B and list of transitional substances of the Montreal Protocol and the London Amendments respectively
2. Class I and II ozone depleting substances in the Clean Air Act Amendments of 1990 by the Environmental Protection Agency (EPA) in the USA
3. Council Decision 88/540/EEC and 91/690/EEC Annex A, B and C (transitional substances) respectively.

Vishay Semiconductor GmbH can certify that our semiconductors are not manufactured with ozone depleting substances and do not contain such substances.

We reserve the right to make changes to improve technical design  
and may do so without further notice.

Parameters can vary in different applications. All operating parameters must be validated for each customer application by the customer. Should the buyer use Vishay Semiconductors products for any unintended or unauthorized application, the buyer shall indemnify Vishay Semiconductors against all claims, costs, damages, and expenses, arising out of, directly or indirectly, any claim of personal damage, injury or death associated with such unintended or unauthorized use.

Vishay Semiconductor GmbH, P.O.B. 3535, D-74025 Heilbronn, Germany  
Telephone: 49 (0)7131 67 2831, Fax number: 49 (0)7131 67 2423