

Optocoupler, Photodarlington Output, With Internal Rbe (Single, Dual, Quad Channel)

Features

- Internal RBE for High Stability
- Four Available CTR Categories per Package Type
- $BV_{CEO} > 60\text{ V}$
- Standard DIP Packages
- Lead-free component
- Component in accordance to RoHS 2002/95/EC and WEEE 2002/96/EC

Agency Approvals

- UL1577, File No. E52744 System Code H or J, Double Protection
- DIN EN 60747-5-2 (VDE0884)
DIN EN 60747-5-5 pending
Available with Option 1

Description

IL66, ILD66, and ILQ66 are optically coupled isolators employing Gallium Arsenide infrared emitters and silicon photodarlington detectors. Switching can be accomplished while maintaining a high degree of isolation between driving and load circuits, with no crosstalk between channels.

Single Channel

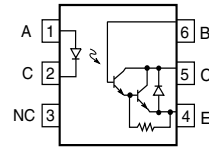
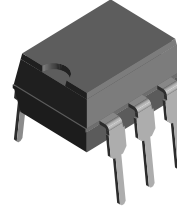

Dual Channel

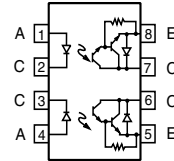
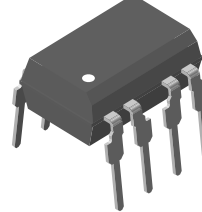

Quad Channel

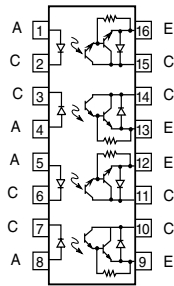
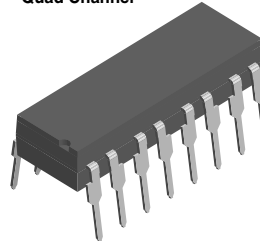

i179014



Order Information

Part	Remarks
IL66-1	CTR $\geq 100\%$, DIP-6
IL66-2	CTR $\geq 300\%$, DIP-6
IL66-3	CTR $\geq 400\%$, DIP-6
IL66-4	CTR $\geq 500\%$, DIP-6
ILD66-1	CTR $\geq 100\%$, DIP-8
ILD66-2	CTR $\geq 300\%$, DIP-8
ILD66-3	CTR $\geq 400\%$, DIP-8
ILD66-4	CTR $\geq 500\%$, DIP-8
ILQ66-1	CTR $\geq 100\%$, DIP-16
ILQ66-2	CTR $\geq 300\%$, DIP-16
ILQ66-3	CTR $\geq 400\%$, DIP-16
ILQ66-4	CTR $\geq 500\%$, DIP-16
IL66-4X009	CTR $\geq 500\%$, SMD-8 (option 9)

Part	Remarks
ILD66-2X007	CTR $\geq 300\%$, SMD-8 (option 7)
ILD66-3X009	CTR $\geq 400\%$, SMD-8 (option 9)
ILD66-4X009	CTR $\geq 500\%$, SMD-8 (option 9)
ILQ66-4X007	CTR $\geq 500\%$, SMD-16 (option 7)
ILQ66-4X009	CTR $\geq 500\%$, SMD-16 (option 9)

For additional information on the available options refer to Option Information.

Absolute Maximum Ratings

$T_{amb} = 25\text{ }^{\circ}\text{C}$, unless otherwise specified

Stresses in excess of the absolute Maximum Ratings can cause permanent damage to the device. Functional operation of the device is not implied at these or any other conditions in excess of those given in the operational sections of this document. Exposure to absolute Maximum Rating for extended periods of the time can adversely affect reliability.

Input

Each Channel

Parameter	Test condition	Symbol	Value	Unit
Peak reverse voltage		V_{RM}	6.0	V
Forward continuous current		I_F	60	mA
Power dissipation		P_{diss}	100	mW
Derate linearly from 25 °C			1.33	mW/°C

Output

Parameter	Test condition	Symbol	Value	Unit
Power dissipation		P_{diss}	150	mW
Derate linearly from 25 °C			2.0	mW/°C

Coupler

Parameter	Test condition	Part	Symbol	Value	Unit
Isolation test voltage	$t = 1.0\text{ sec.}$		V_{ISO}	5300	V_{RMS}
Total package power dissipation		IL66	P_{tot}	250	mW
		ILD66	P_{tot}	400	mW
		ILQ66	P_{tot}	500	mW
Derate linearly from 25 °C		IL66		3.3	mW/°C
		ILD66		5.33	mW/°C
		ILQ66		6.67	mW/°C
Creepage				≥ 7.0	min
Clearance				≥ 7.0	min
Comparative tracking index				175	
Isolation resistance	$V_{IO} = 500\text{ V}, T_{amb} = 25\text{ }^{\circ}\text{C}$		R_{IO}	$\geq 10^{12}$	Ω
	$V_{IO} = 500\text{ V}, T_{amb} = 100\text{ }^{\circ}\text{C}$		R_{IO}	$\geq 10^{11}$	Ω
Storage temperature			T_{stg}	- 55 to + 125	°C
Operating temperature			T_{amb}	- 55 to + 100	°C
Lead soldering time at 260 °C				10	sec.



Electrical Characteristics

$T_{amb} = 25\text{ }^{\circ}\text{C}$, unless otherwise specified

Minimum and maximum values are testing requirements. Typical values are characteristics of the device and are the result of engineering evaluation. Typical values are for information only and are not part of the testing requirements.

Input

GaAs Emitter

Parameter	Test condition	Symbol	Min	Typ.	Max	Unit
Forward voltage	$I_F = 20\text{ mA}$	V_F		1.25	1.5	V
Reverse current	$V_R = 6.0\text{ V}$	I_R		0.1	10	μA
Capacitance	$V_R = 0\text{ V}$	C_O		25		pF

Output

Parameter	Test condition	Symbol	Min	Typ.	Max	Unit
Collector-emitter breakdown voltage	$I_C = 1.0\text{ mA}$, $I_F = 0$	BV_{CEO}	60			V
Collector-base breakdown voltage (IL66)	$I_C = 10\text{ }\mu\text{A}$	BV_{CBO}	60			V
Collector-emitter leakage current	$V_{CE} = 50\text{ V}$, $I_F = 0$	I_{CEO}		1.0	100	nA
Capacitance, collector-emitter	$V_{CE} = 10\text{ V}$			3.4		pF

Coupler

Parameter	Test condition	Symbol	Min	Typ.	Max	Unit
Saturation voltage, collector-emitter	$I_C = 10\text{ mA}$, $I_F = 10\text{ mA}$	V_{CEsat}		0.9	1.0	V

Current Transfer Ratio

Parameter	Test condition	Part	Symbol	Min	Typ.	Max	Unit
Current Transfer Ratio	$I_F = 2.0\text{ mA}$, $V_{CE} = 10\text{ V}$	IL(D,Q)66-1	CTR	100	400		%
		IL(D,Q)66-2	CTR	300	500		%
	$I_F = 0.7\text{ mA}$, $V_{CE} = 10\text{ V}$	IL(D,Q)66-3	CTR	400	500		%
	$I_F = 2.0\text{ mA}$, $V_{CE} = 5.0\text{ V}$	IL(D,Q)66-4	CTR	500	750		%

Switching Characteristics

Parameter	Test condition	Symbol	Min	Typ.	Max	Unit
Rise time -1, -2, -4	$V_{CC} = 10\text{ V}$	t_r			200	μs
Fall time -1, -2, -4	$I_F = 2.0\text{ mA}$, $R_L = 100\ \Omega$	t_f			200	μs
Rise time -3	$I_F = 0.7\text{ mA}$	t_r			200	μs
Fall time -3	$V_{CC} = 10\text{ V}$, $R_L = 100\ \Omega$	t_f			200	μs

Typical Characteristics ($T_{amb} = 25\text{ }^\circ\text{C}$ unless otherwise specified)

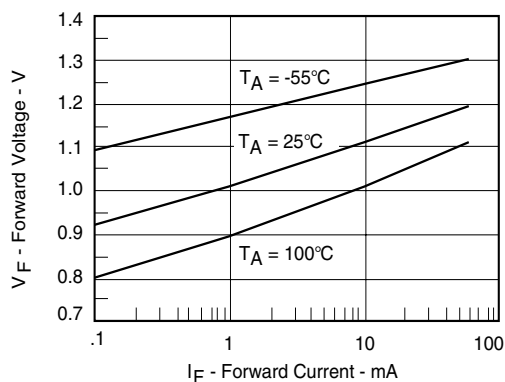

#66_01

Figure 1. Forward Voltage vs. Forward Current

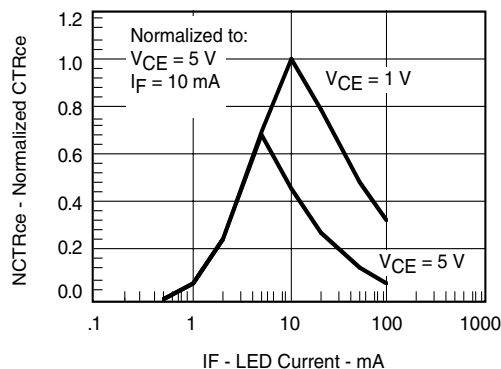

#66_03

Figure 3. Normalized Non-saturated and Saturated CTR_{CE} vs. LED Current

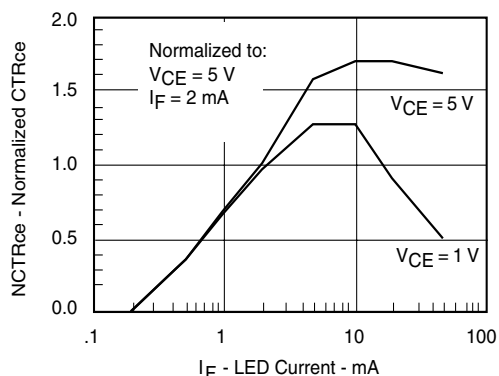

#66_02

Figure 2. Normalized Non-saturated and Saturated CTR_{CE} vs. LED Current

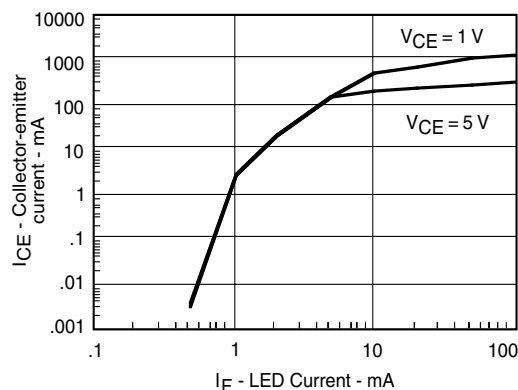

#66_04

Figure 4. Non-Saturated and Saturated Collector Emitter Current vs. LED Current

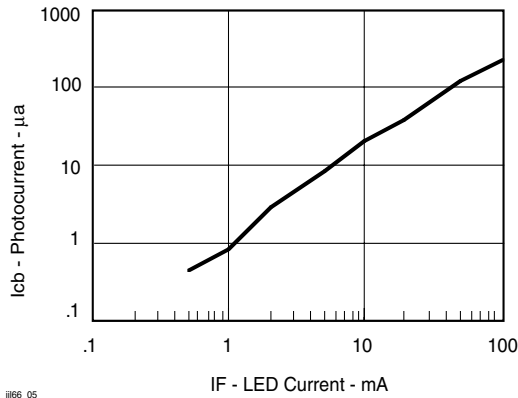

#66_05

Figure 5. Collector-Base Photocurrent vs. LED Current

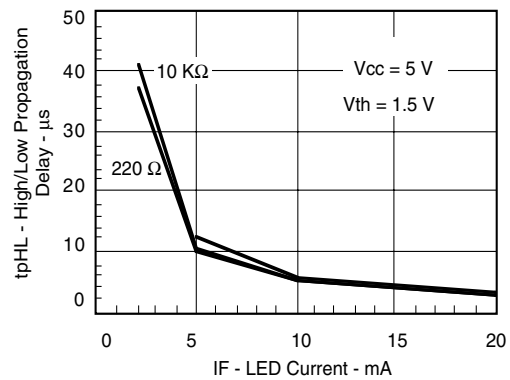

#66_08

Figure 8. High to low Propagation Delay vs. Collector Load Resistance and LED Current

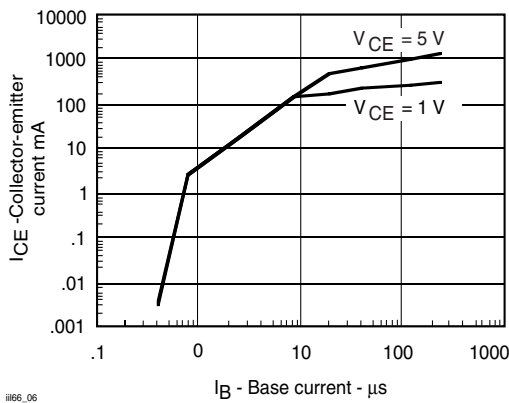

#66_06

Figure 6. Collector-Emitter Current vs. LED Current

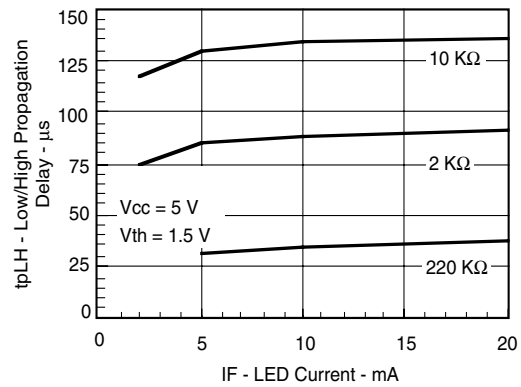

#66_09

Figure 9. Low to High Propagation Delay vs. Collector Load Resistance and LED Current

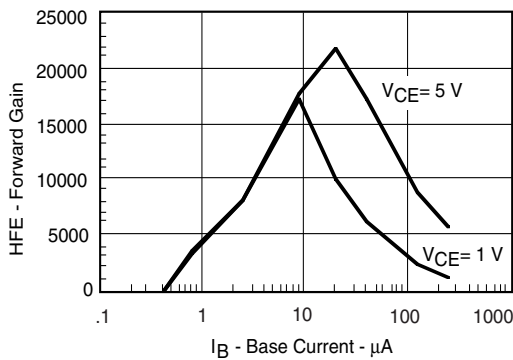

#66_07

Figure 7. Non-Saturated and Saturated HFE vs. LED Current

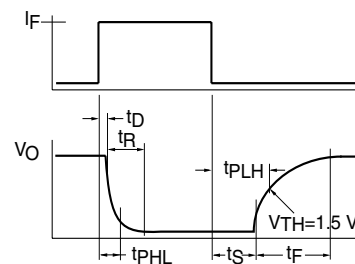

#66_10

Figure 10. Switching Waveform

Figure 11. Switching Schematic

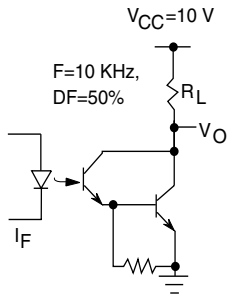

#66_11

Package Dimensions in mm

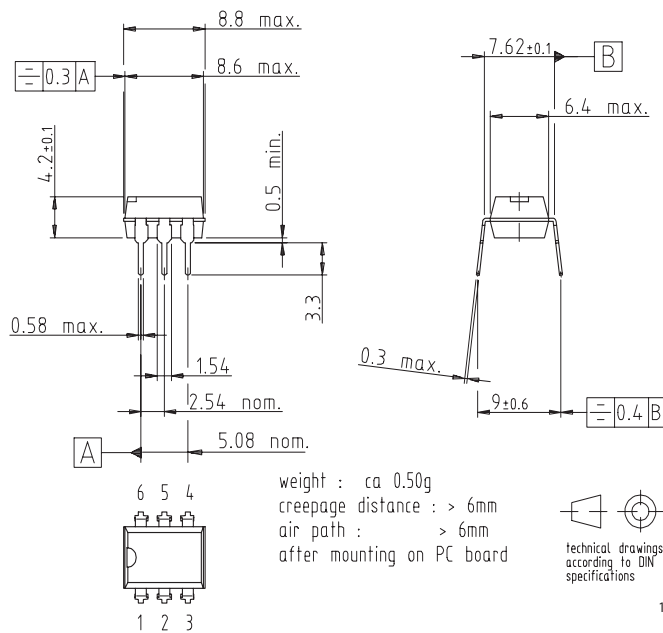

Package Dimensions in Inches (mm)

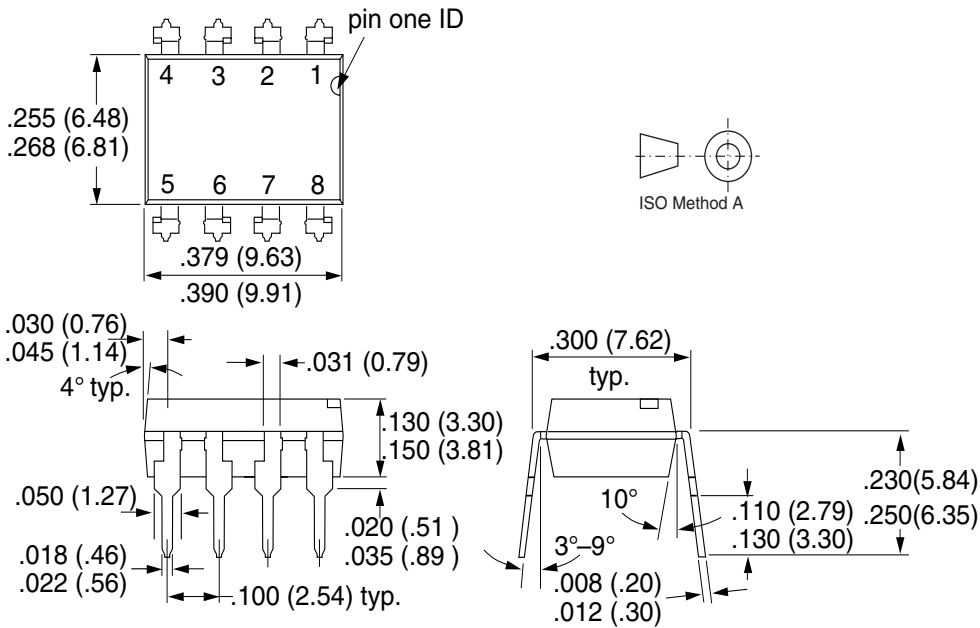

Package Dimensions in Inches (mm)

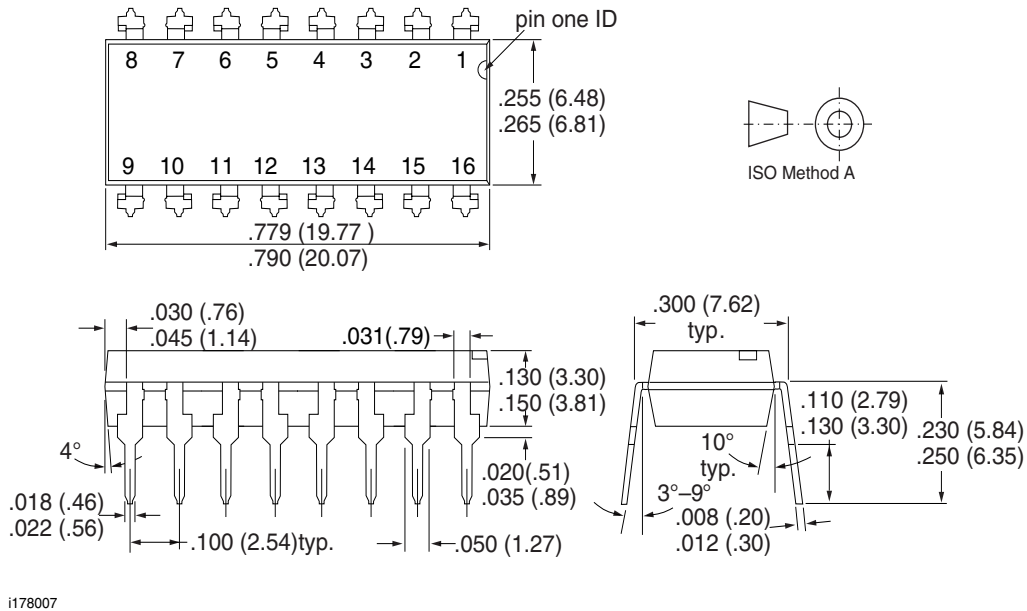

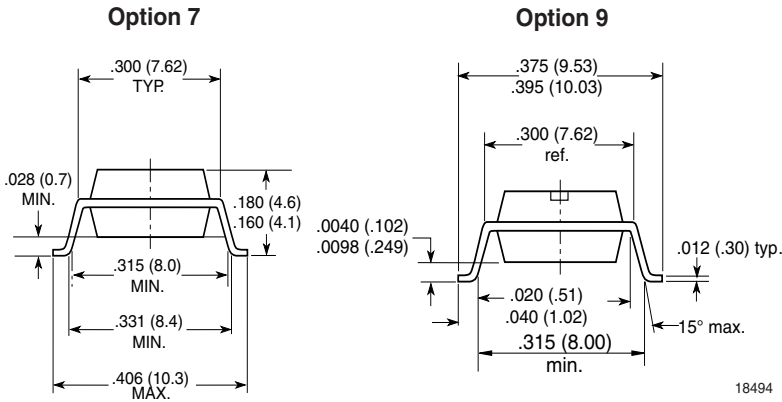



Ozone Depleting Substances Policy Statement

It is the policy of Vishay Semiconductor GmbH to

1. Meet all present and future national and international statutory requirements.
2. Regularly and continuously improve the performance of our products, processes, distribution and operating systems with respect to their impact on the health and safety of our employees and the public, as well as their impact on the environment.

It is particular concern to control or eliminate releases of those substances into the atmosphere which are known as ozone depleting substances (ODSs).

The Montreal Protocol (1987) and its London Amendments (1990) intend to severely restrict the use of ODSs and forbid their use within the next ten years. Various national and international initiatives are pressing for an earlier ban on these substances.

Vishay Semiconductor GmbH has been able to use its policy of continuous improvements to eliminate the use of ODSs listed in the following documents.

1. Annex A, B and list of transitional substances of the Montreal Protocol and the London Amendments respectively
2. Class I and II ozone depleting substances in the Clean Air Act Amendments of 1990 by the Environmental Protection Agency (EPA) in the USA
3. Council Decision 88/540/EEC and 91/690/EEC Annex A, B and C (transitional substances) respectively.

Vishay Semiconductor GmbH can certify that our semiconductors are not manufactured with ozone depleting substances and do not contain such substances.

We reserve the right to make changes to improve technical design and may do so without further notice.

Parameters can vary in different applications. All operating parameters must be validated for each customer application by the customer. Should the buyer use Vishay Semiconductors products for any unintended or unauthorized application, the buyer shall indemnify Vishay Semiconductors against all claims, costs, damages, and expenses, arising out of, directly or indirectly, any claim of personal damage, injury or death associated with such unintended or unauthorized use.

Vishay Semiconductor GmbH, P.O.B. 3535, D-74025 Heilbronn, Germany
Telephone: 49 (0)7131 67 2831, Fax number: 49 (0)7131 67 2423