

Optocoupler, Phototransistor Output, Dual Channel

Features

- Current Transfer Ratio, 50 % Typical
- Leakage Current, 1.0 nA Typical
- Two Isolated Channels Per Package

Agency Approvals

- UL - File No. E52744 System Code H or J
- DIN EN 60747-5-2(VDE0884)
DIN EN 60747-5-5 pending
Available with Option 1
- CSA 93751
- BSI IEC60950 IEC60965

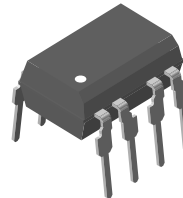

1179016

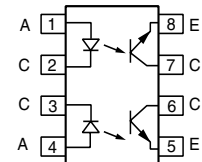

Description

The ILCT6/ MCT6 is a two channel optocoupler for high density applications. Each channel consists of an optically coupled pair with a Gallium Arsenide infrared LED and a silicon NPN phototransistor. Signal information, including a DC level, can be transmitted by the device while maintaining a high degree of electrical isolation between input and output.

The ILCT6/ MCT6 is especially designed for driving medium-speed logic, where it may be used to eliminate troublesome ground loop and noise problems. It

can also be used to replace relays and transformers in many digital interface applications, as well as analog applications such as CRT modulation.

Order Information

Part	Remarks
ILCT6	CTR ≥ 20 %, DIP-8
MCT6	CTR ≥ 20 %, DIP-8
ILCT6-X007	CTR ≥ 20 %, SMD-8 (option 7)
ILCT6-X009	CTR ≥ 20 %, SMD-8 (option 9)
MCT6-X007	CTR ≥ 20 %, SMD-8 (option 7)
MCT6-X009	CTR ≥ 20 %, SMD-8 (option 9)

For additional information on the available options refer to Option Information.

Absolute Maximum Ratings

$T_{amb} = 25\text{ }^{\circ}\text{C}$, unless otherwise specified

Stresses in excess of the absolute Maximum Ratings can cause permanent damage to the device. Functional operation of the device is not implied at these or any other conditions in excess of those given in the operational sections of this document. Exposure to absolute Maximum Rating for extended periods of the time can adversely affect reliability.

Input

Parameter	Test condition	Symbol	Value	Unit
Rated forward current, DC			60	mA
Peak forward current, DC	1.0 μs pulse, 300 pps	I_{FM}	3.0	A
Power dissipation		P_{diss}	100	mW
Derate linearly from 25 $^{\circ}\text{C}$			1.3	mW/ $^{\circ}\text{C}$

Output

Parameter	Test condition	Symbol	Value	Unit
Collector current		I_C	30	mA
Collector-emitter breakdown voltage		BV_{CEO}	30	V
Power dissipation		P_{diss}	150	mW
Derate linearly from 25 °C			2	mW/°C

Coupler

Parameter	Test condition	Symbol	Value	Unit
Isolation test voltage		V_{ISO}	5300	V_{RMS}
Isolation resistance	$V_{IO} = 500\text{ V}, T_{amb} = 25\text{ °C}$	R_{IO}	$\geq 10^{12}$	Ω
	$V_{IO} = 500\text{ V}, T_{amb} = 100\text{ °C}$	R_{IO}	$\geq 10^{11}$	Ω
Creepage			≥ 7.0	mm
Clearance			≥ 7.0	mm
Total package dissipation		P_{tot}	400	mW
Derate linearly from 25 °C			5.33	mW/°C
Storage temperature		T_{stg}	- 55 to + 150	°C
Operating temperature		T_{amb}	- 55 to + 100	°C
Lead soldering time at 260 °C			10	sec.

Electrical Characteristics

$T_{amb} = 25\text{ °C}$, unless otherwise specified

Minimum and maximum values are testing requirements. Typical values are characteristics of the device and are the result of engineering evaluation. Typical values are for information only and are not part of the testing requirements.

Input

Parameter	Test condition	Symbol	Min	Typ.	Max	Unit
Forward voltage	$I_F = 20\text{ mA}$	V_F		1.25	1.50	V
Reverse current	$V_R = 3.0\text{ V}$	I_R		0.1	10	μA
Junction capacitance	$V_F = 0\text{ V}$	C_j		25		pF

Output

Parameter	Test condition	Symbol	Min	Typ.	Max	Unit
Collector-emitter breakdown voltage	$I_C = 10\text{ }\mu\text{A}, I_E = 10\text{ }\mu\text{A}$	BV_{CEO}	30	65		V
Emitter-collector breakdown voltage	$I_C = 10\text{ }\mu\text{A}, I_E = 10\text{ }\mu\text{A}$	BV_{ECO}	7.0	10		V
Collector-emitter leakage current	$V_{CE} = 10\text{ V}$	I_{CEO}		1.0	100	nA
Collector-emitter capacitance	$V_{CE} = 0\text{ V}$	C_{CE}		8.0		pf

Coupler

Parameter	Test condition	Symbol	Min	Typ.	Max	Unit
Saturation voltage, collector-emitter	$I_C = 2.0 \text{ mA}$, $I_F = 16 \text{ mA}$	V_{CEsat}			0.40	V
Capacitance (input-output)	$f = 1.0 \text{ MHz}$	C_{IO}		0.5		pF
Capacitance between channels	$f = 1.0 \text{ MHz}$			0.4		pF
Bandwidth	$I_C = 2.0 \text{ mA}$, $V_{CC} = 10 \text{ V}$, $R_L = 100 \Omega$			150		kHz

Current Transfer Ratio

Parameter	Test condition	Symbol	Min	Typ.	Max	Unit
DC Current Transfer Ratio	$I_F = 10 \text{ mA}$, $V_{CE} = 10 \text{ V}$	CTR_{DC}	20	50		%

Switching Characteristics

Parameter	Test condition	Symbol	Min	Typ.	Max	Unit
Switching times, output transistor	$I_C = 2.0 \text{ mA}$, $R_E = 100 \Omega$, $V_{CE} = 10 \text{ V}$	t_{on} , t_{off}		3.0		μs

Typical Characteristics ($T_{amb} = 25 \text{ }^\circ\text{C}$ unless otherwise specified)

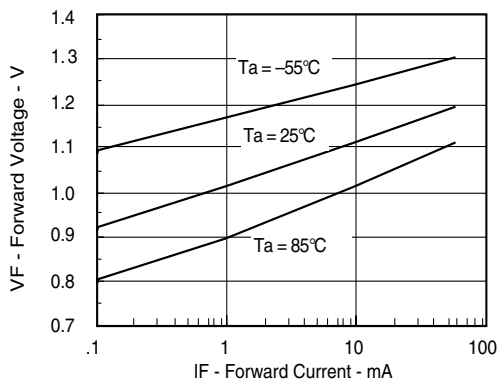

ilct6_01

Fig. 1 Forward Voltage vs. Forward Current

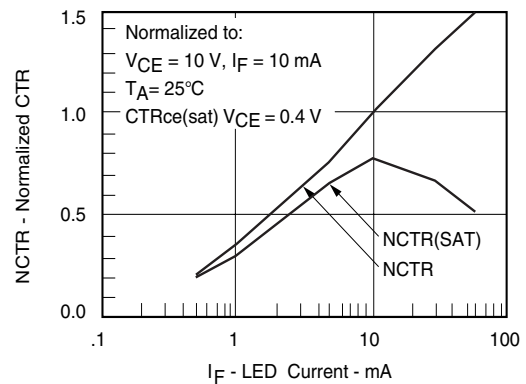

ilct6_02

Fig. 2 Normalized Non-Saturated and Saturated CTR vs. LED Current

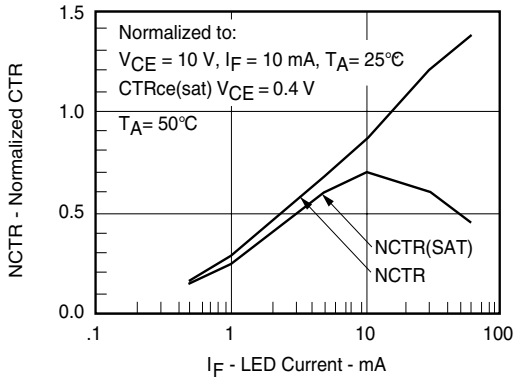

ilct6_03

Fig. 3 Normalized Non-Saturated and Saturated CTR vs. LED Current

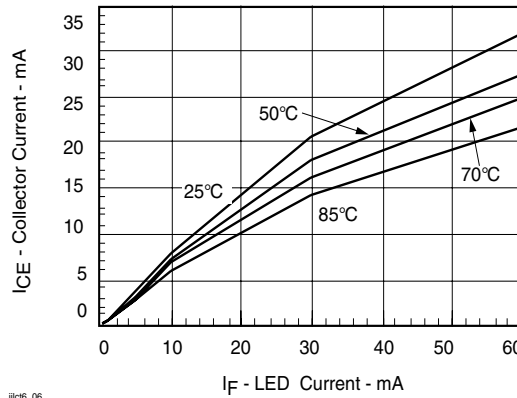

ilct6_06

Fig. 6 Collector-Emitter Current vs. Temperature and LED Current

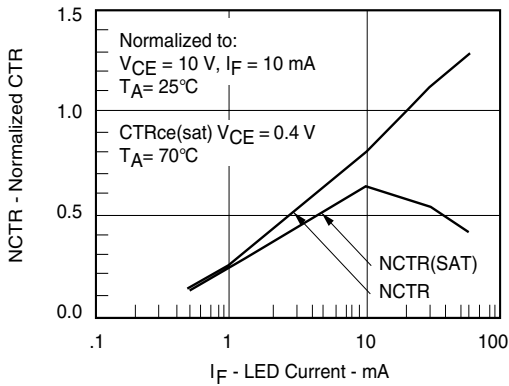

ilct6_04

Fig. 4 Normalized Non-Saturated and Saturated CTR vs. LED Current

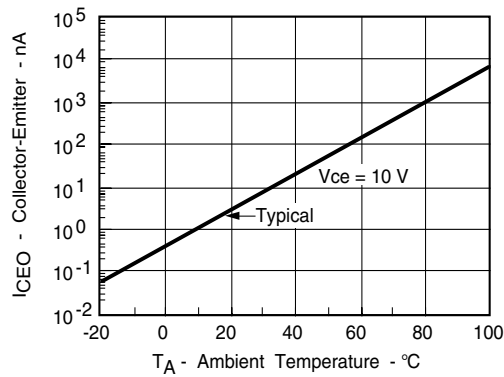

ilct6_07

Fig. 7 Collector-Emitter Leakage Current vs. Temp.

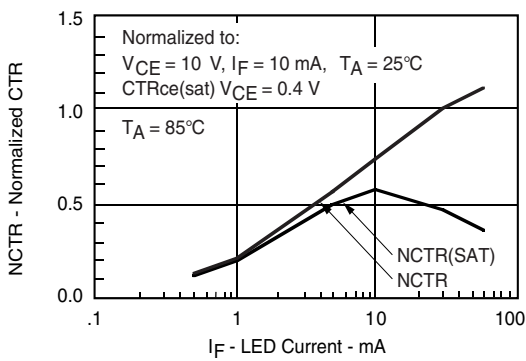

ilct6_05

Fig. 5 Normalized Non-Saturated and Saturated CTR vs. LED Current

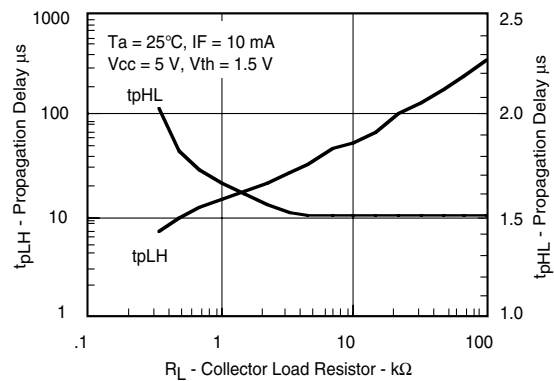

ilct6_08

Fig. 8 Propagation Delay vs. Collector Load Resistor

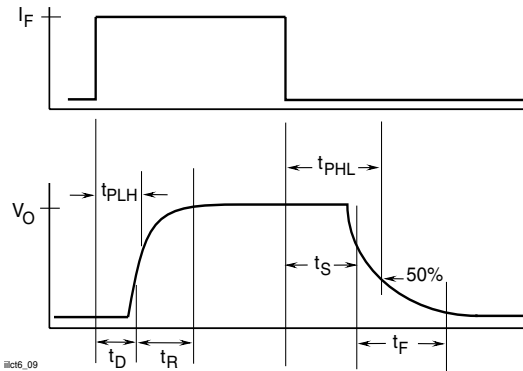
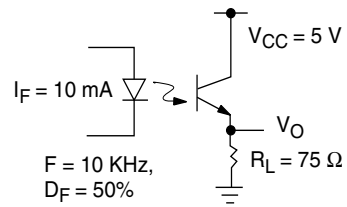

Fig. 9 Switching Timing



ilct6_10

Fig. 10 Switching Schematic

Package Dimensions in Inches (mm)

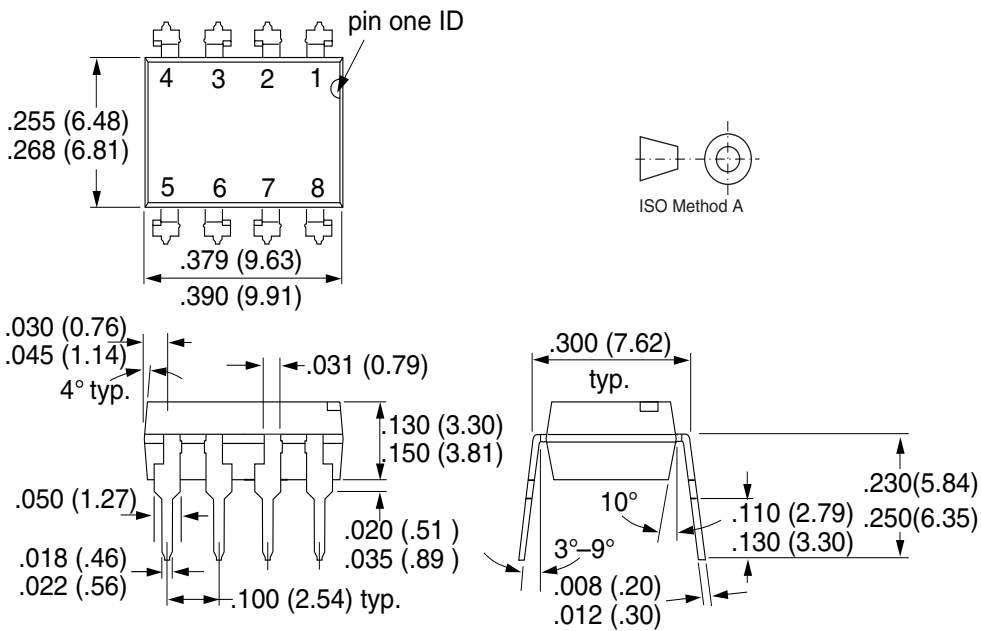

i178006

Option 7

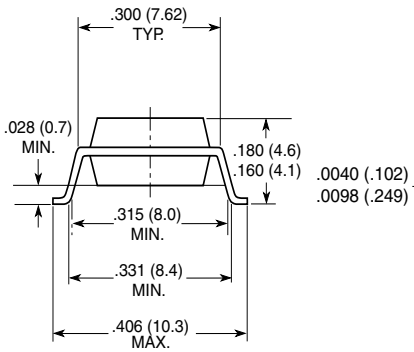

Option 9

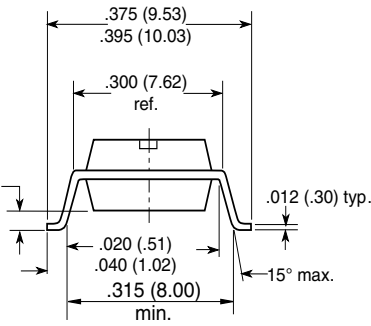

18494



Ozone Depleting Substances Policy Statement

It is the policy of **Vishay Semiconductor GmbH** to

1. Meet all present and future national and international statutory requirements.
2. Regularly and continuously improve the performance of our products, processes, distribution and operating systems with respect to their impact on the health and safety of our employees and the public, as well as their impact on the environment.

It is particular concern to control or eliminate releases of those substances into the atmosphere which are known as ozone depleting substances (ODSs).

The Montreal Protocol (1987) and its London Amendments (1990) intend to severely restrict the use of ODSs and forbid their use within the next ten years. Various national and international initiatives are pressing for an earlier ban on these substances.

Vishay Semiconductor GmbH has been able to use its policy of continuous improvements to eliminate the use of ODSs listed in the following documents.

1. Annex A, B and list of transitional substances of the Montreal Protocol and the London Amendments respectively
2. Class I and II ozone depleting substances in the Clean Air Act Amendments of 1990 by the Environmental Protection Agency (EPA) in the USA
3. Council Decision 88/540/EEC and 91/690/EEC Annex A, B and C (transitional substances) respectively.

Vishay Semiconductor GmbH can certify that our semiconductors are not manufactured with ozone depleting substances and do not contain such substances.

**We reserve the right to make changes to improve technical design
and may do so without further notice.**

Parameters can vary in different applications. All operating parameters must be validated for each customer application by the customer. Should the buyer use Vishay Semiconductors products for any unintended or unauthorized application, the buyer shall indemnify Vishay Semiconductors against all claims, costs, damages, and expenses, arising out of, directly or indirectly, any claim of personal damage, injury or death associated with such unintended or unauthorized use.

Vishay Semiconductor GmbH, P.O.B. 3535, D-74025 Heilbronn, Germany
Telephone: 49 (0)7131 67 2831, Fax number: 49 (0)7131 67 2423