



FEATURES

- Current Limit Protection
- I/O Isolation, 3000 V_{RMS}
- Typical R_{ON} 20 Ω
- Load Voltage 350 V
- Load Current 120 mA
- High Surge Capability
- Linear, AC/DC Operation
- Clean Bounce Free Switching
- Low Power Consumption
- High Reliability Monolithic Receptor
- SMD lead available on tape and reel
- Equivalent to CPC1035N

AGENCY APPROVALS

- UL – File No. E52744
- BSI/BABT Cert. No. 7980

APPLICATIONS

- General Telecom Switching
 - On/off Hook Control
 - Ring Delay
 - Dial Pulse
 - Ground Start
 - Ground Fault Protection
- Instrumentation
- Industrial Controls
- See App Note 56

DESCRIPTION

The LH1546AEF (4 Pin SOP) is robust, ideal for telecom and ground fault applications. It is a SPST normally open switch (1 Form A) that replaces electromechanical relays in many applications. It is constructed using a GaAs LED for actuation control and an integrated monolithic die for the switch output. The die, fabricated in a high-voltage dielectrically isolated BCDMOS technology, is comprised of a photodiode array, switch control circuitry and MOSFET switches. In addition, it employs current-limiting circuitry which meets FCC 68.302 and other regulatory voltage surge requirements when over-voltage protection is provided.

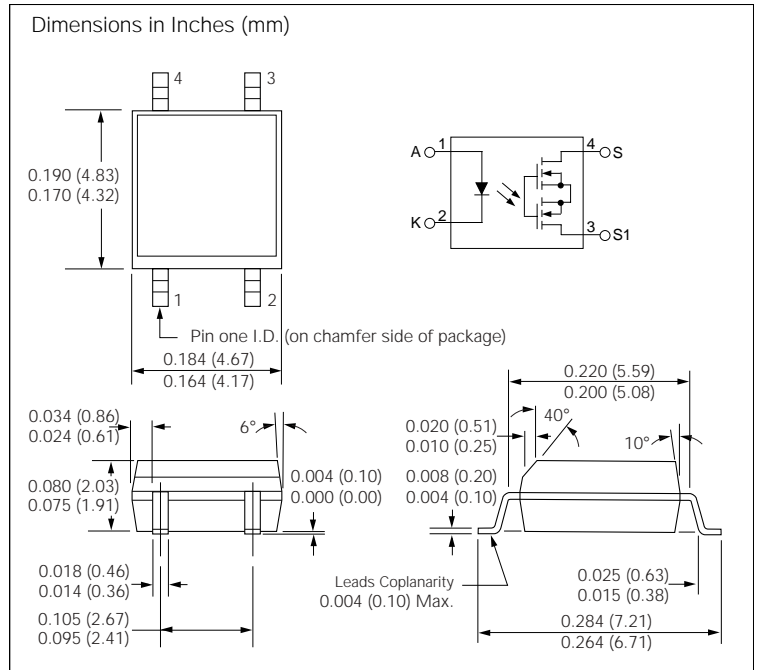

Part Identification

Part Number	Description
LH1546AEF	4-pin SOP, Tubes
LH1546AEFTR	4-pin SOP, Tape and Reel

Recommended Operating Conditions

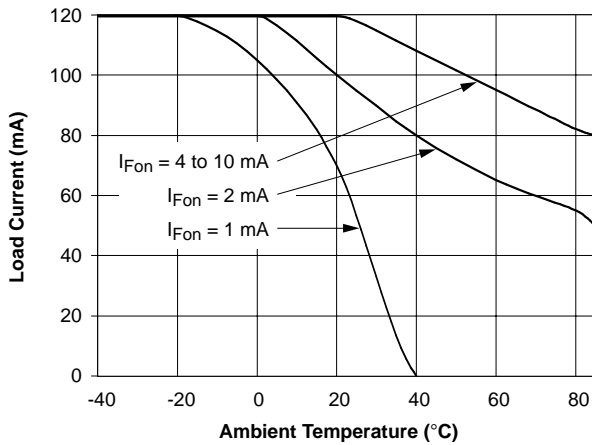

Absolute Maximum Ratings, $T_A=25^\circ\text{C}$

Stresses in excess of the absolute Maximum Ratings can cause permanent damage to the device. These are absolute stress ratings only. Functional operation of the device is not implied at these or any other conditions in excess of those given in the operational sections of this document. Exposure to absolute Maximum Ratings for extended periods of time can adversely affect reliability.

Ambient Temperature Range	-40 to +85°C
Storage Temperature Range	-40 to +150°C
Soldering Temperature (t=10 s. Max.)	260°C
Isolation Test Voltage (for 1.0 s.)	3000 V_{RMS}
Isolation Resistance	
$V_{IO}=500 \text{ V}, T_A=25^\circ\text{C}$	$\geq 10^{12} \Omega$
$V_{IO}=500 \text{ V}, T_A=100^\circ\text{C}$	$\geq 10^{11} \Omega$
SSR Output Power Dissipation (continuous)	550 mW
LED Continuous Forward Current	50 mA
LED Reverse Voltage ($I_R \leq 10 \mu\text{A}$)	6.0 V
DC or Peak AC Load Voltage ($I_L \leq 50 \mu\text{A}$)	350 V
Continuous DC Load Current at 25°C	
Bidirectional	120 mA

Electrical Characteristics, $T_A=25^\circ\text{C}$

Minimum and maximum values are testing requirements. Typical values are characteristics of the device and are the result of engineering evaluations. Typical values are for information only and are not part of the testing requirements.

Parameter	Sym.	Min.	Typ.	Max.	Units	Test Conditions
Input						
LED Forward Current, Switch Turn-on	I_{Fon}	—	1.1	2.0	mA	$I_L=100 \text{ mA}, t=10 \text{ ms}$
LED Forward Current, Switch Turn-off	I_{Foff}	0.2	0.6	—	mA	$V_L \pm 300 \text{ V}$
LED Forward Voltage	V_F	1.0	1.18	1.45	V	$I_F=10 \text{ mA}$
Current Limit	I_{limit}	230	260	370	mA	$I_F=5.0 \text{ mA}, t=5.0 \text{ ms}, V_L=\pm 6.0 \text{ V}$
Output						
ON-resistance, ac/dc: Pin 3 (\pm) to 4 (\pm)	R_{ON}	—	20	35	Ω	$I_F=5.0 \text{ mA}, I_L=50 \text{ mA}$
OFF-resistance	R_{OFF}	0.5	5000	—	G Ω	$I_F=0 \text{ mA}, V_L=\pm 100 \text{ V}$
Off-state Leakage Current	I_O	—	0.32	200	nA	$I_F=0 \text{ mA}, V_L=\pm 100 \text{ V}$
		—	—	1.0	μA	$I_F=0 \text{ mA}, V_L=\pm 350 \text{ V}$
Output Capacitance, Pin 3 to 4	C_O	—	55	—	pF	$I_F=0 \text{ mA}, V_L=1.0 \text{ V}$
		—	10	—	pF	$I_F=0 \text{ mA}, V_L=50 \text{ V}$
Transfer						
Input/Output Capacitance	C_{ISO}	—	0.6	—	pF	$V_{ISO}=1.0 \text{ V}$
Turn-on Time	t_{on}	—	2.0	3.0	ms	$I_F=5.0 \text{ mA}, I_L=50 \text{ mA}$
Turn-off Time	t_{off}	—	0.08	3.0	ms	$I_F=5.0 \text{ mA}, I_L=50 \text{ mA}$

Typical Performance Characteristics

Figure 1. LED Voltage vs. Temperature

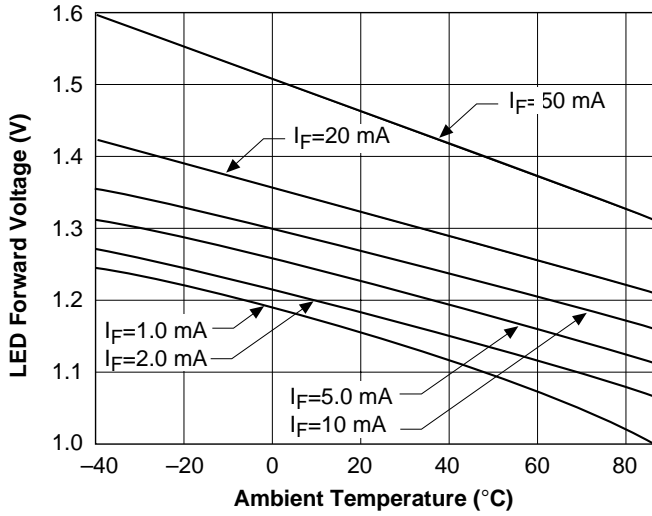

Figure 4. Current Limit vs. Temperature

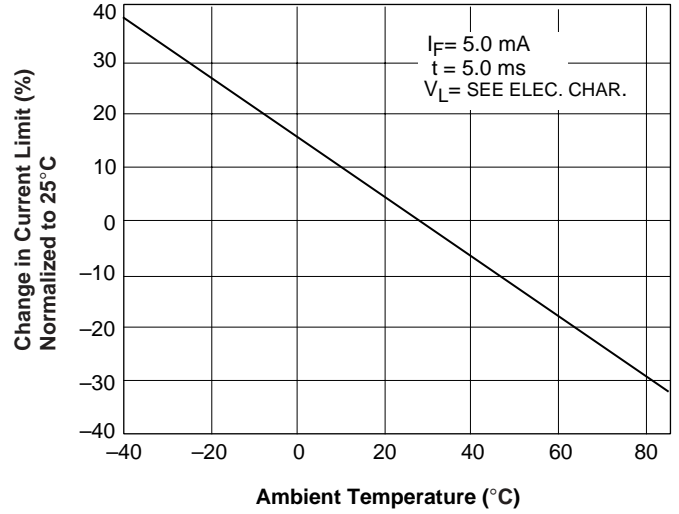

Figure 2. LED Current for Switch Turn-on vs. Temperature

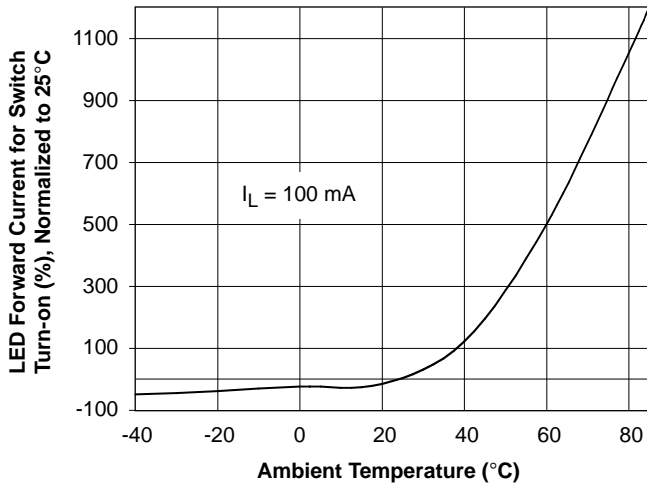

Figure 5. Switch Breakdown Voltage vs. Temperature

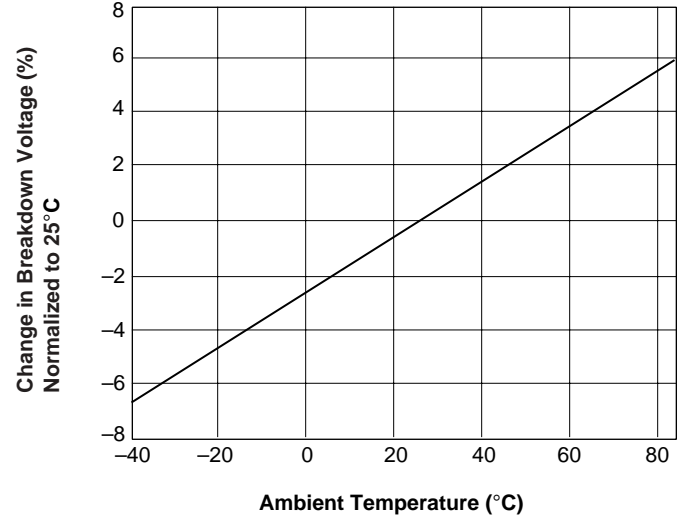

Figure 3. ON-Resistance vs. Temperature

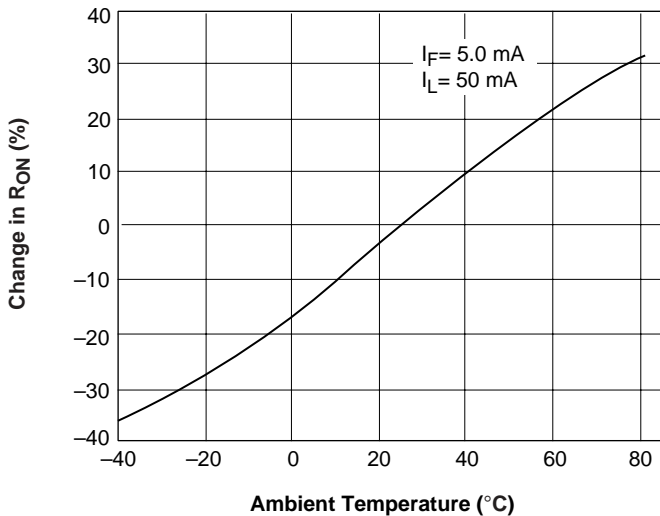

Figure 6. Switch Capacitance vs. Applied Voltage

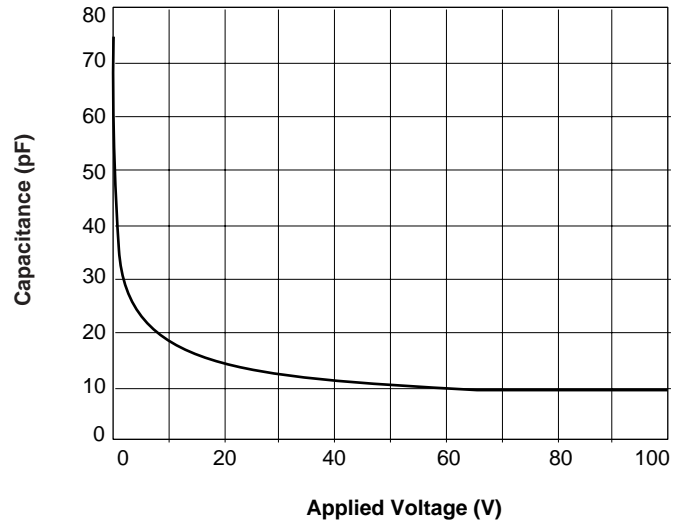

Figure 7. Leakage Current vs. Applied Voltage

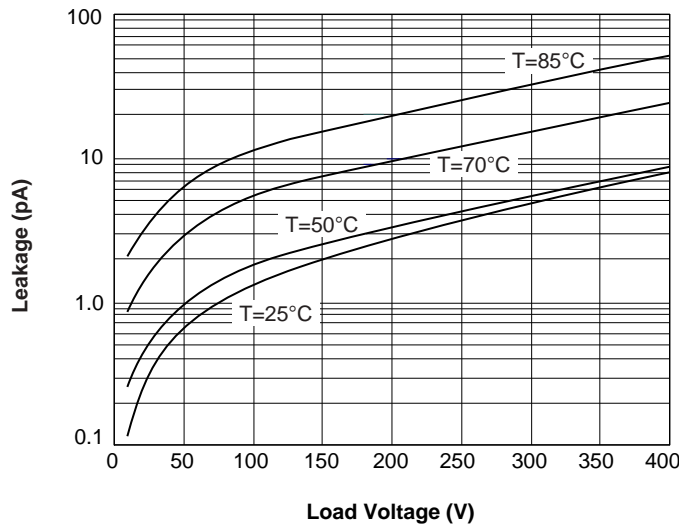

Figure 9. Turn-off Time vs. Temperature

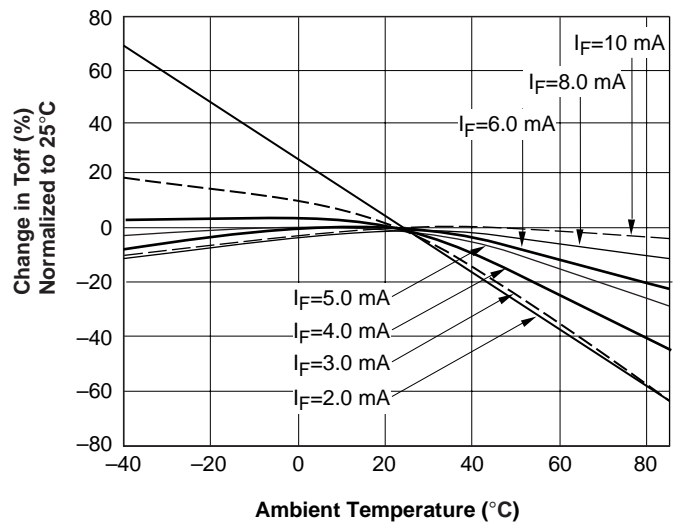

Figure 8. Leakage Current vs. Applied Voltage

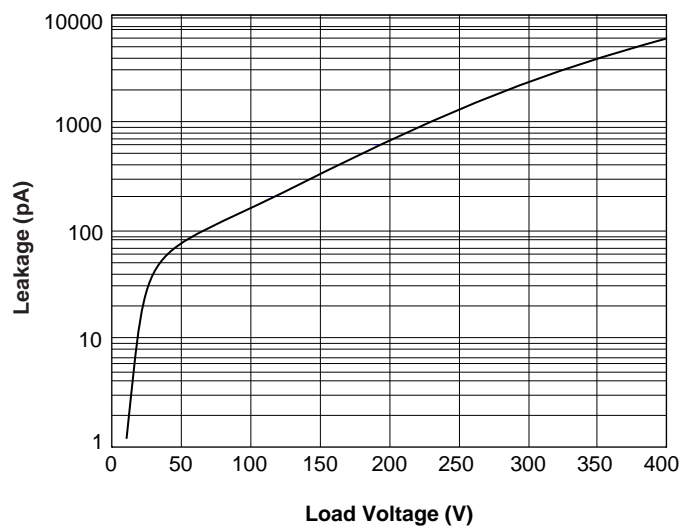

Figure 10. Turn-on Time vs. LED Current

