

## High Speed Optocoupler, 5 MBd, 1 kV/ $\mu$ s dV/dt

### Features

- Data Rate 5.0 Mbits/s (2.5 Mbit/s over Temperature)
- Buffer
- Isolation Test Voltage, 5300 V RMS for 1.0 s
- TTL, LSTTL and CMOS Compatible
- Internal Shield for Very High Common Mode Transient Immunity
- Wide Supply Voltage Range (4.5 to 15 V)
- Low Input Current (1.6 mA to 5.0 mA)
- Three State Output (SFH6700/ 19)
- Totem Pole Output (SFH6701/ 02/ 11/ 12)
- Open Collector Output (SFH6705)
- Specified from 0 °C to 85 °C

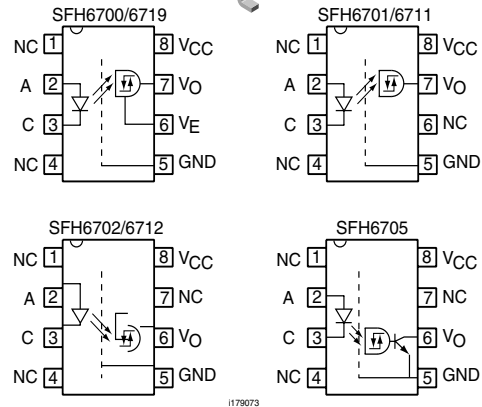
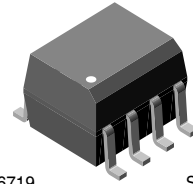

### Agency Approvals

- UL - File No. E52744 System Code H or J
- DIN EN 60747-5-2(VDE0884)  
DIN EN 60747-5-5 pending  
Available with Option 1

### Applications

Industrial Control  
 Replace Pulse Transformers  
 Routine Logic Interfacing  
 Motion/Power Control  
 High Speed Line Receiver  
 Microprocessor System Interfaces  
 Computer Peripheral Interfaces

### Description

The SFH67xx high speed optocoupler series consists of a GaAlAs infrared emitting diode, optically coupled with an integrated photo detector. The detector incorporates a Schmitt-Trigger stage for improved noise immunity. Using the Enable input, the output can be switched to the high ohmic state, which is necessary for data bus applications. A Faraday shield provides a common mode transient immunity of 1000 V/ $\mu$ s at  $V_{CM} = 50$  V for SFH6700/ 01/ 02/ 05 and 2500 V/ $\mu$ s at  $V_{CM} = 400$  V for SFH6711/ 12/ 19.

The SFH67xx uses an industry standard DIP-8 package. With standard lead bending, creepage distance and clearance of  $\geq 7.0$  mm with lead bending options 6, 7, and 9  $\geq 8$  mm are achieved.

### Order Information

Part	Remarks
SFH6700	Three State Output, DIP-8
SFH6701	Totem Pole Output, DIP-8
SFH6702	Totem Pole Output, DIP-8
SFH6705	Open Collector Output, DIP-8
SFH6711	Totem Pole Output, DIP-8
SFH6712	Totem Pole Output, DIP-8
SFH6719	Three State Output, DIP-8
SFH6700-X009	Three State Output, SMD-8 (option 9)
SFH6701-X006	Totem Pole Output, DIP-8 400 mil (option 6)
SFH6701-X007	Totem Pole Output, SMD-8 (option 7)
SFH6701-X009	Totem Pole Output, SMD-8 (option 9)
SFH6705-X006	Open Collector Output, DIP-8 400 mil (option 6)
SFH6705-X007	Open Collector Output, SMD-8 (option 7)
SFH6711-X007	Totem Pole Output, SMD-8 (option 7)

For additional information on the available options refer to Option Information.

## Truth Table (Positive Logic)

	IR Diode	Enable	Output
SFH6700	on	H	Z
	off	H	Z
SFH6719	on	L	H
	off	L	L
SFH6701	on		H
	off		L
SFH6702	on		H
	off		L
SFH6705	on		H
	off		L
SFH6711	on		H
	off		L
SFH6712	on		H
	off		L

## Absolute Maximum Ratings

$T_{amb} = 25\text{ }^{\circ}\text{C}$ , unless otherwise specified

Stresses in excess of the absolute Maximum Ratings can cause permanent damage to the device. Functional operation of the device is not implied at these or any other conditions in excess of those given in the operational sections of this document. Exposure to absolute Maximum Rating for extended periods of the time can adversely affect reliability.

## Input

Parameter	Test condition	Symbol	Value	Unit
Reverse voltage		$V_R$	3.0	V
DC Forward current		$I_F$	10	mA
Surge forward current	$t \leq 1.0\ \mu\text{s}$	$I_{FSM}$	1.0	A
Power dissipation		$P_{diss}$	20	mW

## Output

Parameter	Test condition	Symbol	Value	Unit
Supply voltage		$V_{CC}$	- 0.5 to + 15	V
Three state enable voltage (SFH6700/19 only)		$V_{EN}$	- 0.5 to + 15	V
Output voltage		$V_O$	- 0.5 to + 15	V
Average output current		$I_O$	25	mA
Power dissipation		$P_{diss}$	100	mW

## Coupler

Parameter	Test condition	Symbol	Value	Unit
Storage temperature range		$T_{stg}$	- 55 to + 125	$^{\circ}\text{C}$
Ambient temperature range		$T_{amb}$	- 40 to + 85	$^{\circ}\text{C}$
Lead soldering temperature	$t = 10\ \text{s}$	$T_{slid}$	260	$^{\circ}\text{C}$
Isolation test voltage		$V_{ISO}$	5300	$V_{RMS}$
Pollution degree			2.0	
Creepage distance and clearance	Standard lead bending		7.0	mm
	Options 6, 7, 9		8.0	mm

Parameter	Test condition	Symbol	Value	Unit
Comparative tracking index per DIN IEC 112/VDE 0303, part 1			175	
Isolation resistance	$V_{IO} = 500 \text{ V}, T_{amb} = 25 \text{ }^\circ\text{C}$	$R_{IO}$	$10^{12}$	$\Omega$
	$V_{IO} = 500 \text{ V}, T_{amb} = 100 \text{ }^\circ\text{C}$	$R_{IO}$	$10^{11}$	$\Omega$

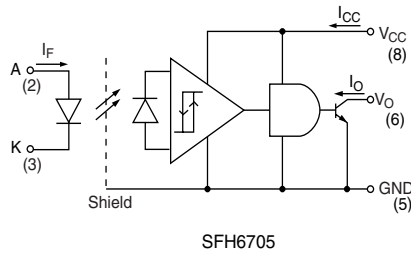
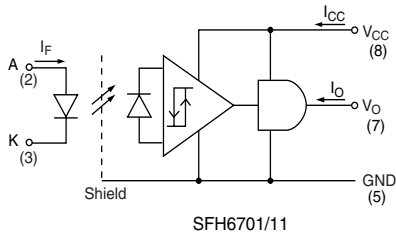
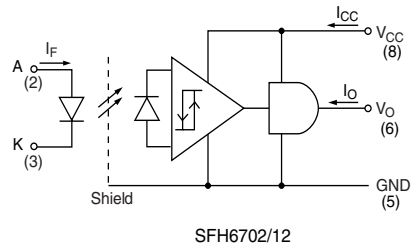
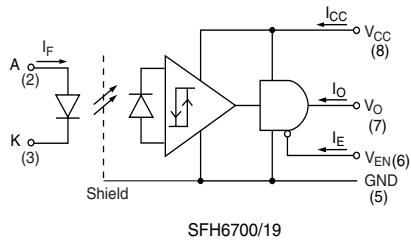

isth6700\_01

Fig. 1 Schematics

## Recommended Operating Conditions

A 0.1  $\mu\text{F}$  bypass capacitor connected between pins 5 and 8 must be used.

Parameter	Test condition	Part	Symbol	Min	Typ.	Max	Unit
Supply voltage			$V_{CC}$	4.5		15	V
Enable voltage high		SFH6700	$V_{EH}$	2.0		15	V
		SFH6719	$V_{EH}$	2.0		15	V
Enable voltage low		SFH6700	$V_{EL}$	0		0.8	V
		SFH6719	$V_{EL}$	0		0.8	V
Forward input current			$I_{Fon}$	1.6 <sup>(1)</sup>		5.0	mA
			$I_{Foff}$			0.1	mA
Operating temperature			$T_A$	0		85	$^\circ\text{C}$
Output pull-up resistor		SFH6705	$R_L$	350		4	$\text{k}\Omega$
Fan Output	$R_L = 1.0 \text{ k}\Omega$	SFH6705	N			16	LS TTL Loads

<sup>(1)</sup> We recommended using a 2.2 mA to permit at least 20 % CTR degradation guard band.



## Electrical Characteristics

$T_{amb} = 25\text{ }^{\circ}\text{C}$ , unless otherwise specified

Minimum and maximum values are testing requirements. Typical values are characteristics of the device and are the result of engineering evaluation. Typical values are for information only and are not part of the testing requirements.

## Input

$0\text{ }^{\circ}\text{C} \leq T_{amb} \leq 85\text{ }^{\circ}\text{C}$ ;  $4.5\text{ V} \leq V_{CC} \leq 15\text{ V}$ ;  $1.6\text{ mA} \leq I_{Fon} \leq 5.0\text{ mA}$ ;  $2.0 \leq V_{EH} \leq 15\text{ V}$ ;  $0 \leq V_{EL} \leq 0.8\text{ V}$ ;  $0\text{ mA} \leq I_{Foff} \leq 0.1\text{ mA}$ ;

Typical values:  $T_{amb} = 25\text{ }^{\circ}\text{C}$ ;  $V_{CC} = 5.0\text{ V}$ ;  $I_{Fon} = 3.0\text{ mA}$  unless otherwise specified

Parameter	Test condition	Symbol	Min	Typ.	Max	Unit
Forward voltage	$I_F = 5.0\text{ mA}$	$V_F$		1.6	1.75	V
	$I_F = 5.0\text{ mA}$ ,	$V_F$			1.8	V
Input current hysteresis	$V_{CC} = 5.0\text{ V}$ , $I_{HYS} = I_{Fon} - I_{Fon}$	$I_{HYS}$		0.1		mA
Reverse current	$V_R = 3.0\text{ V}$	$I_R$		0.5	10	$\mu\text{A}$
Capacitance	$V_R = 0\text{ V}$ , $f = 1.0\text{ MHz}$ ;	$C_O$		60		pF
Thermal resistance		$R_{thja}$		700		K/W



## Output

0 °C ≤ T<sub>amb</sub> ≤ 85 °C; 4.5 V ≤ V<sub>CC</sub> ≤ 15 V; 1.6 mA ≤ I<sub>Fon</sub> ≤ 5.0 mA; 2.0 ≤ V<sub>EH</sub> ≤ 15 V; 0 ≤ V<sub>EL</sub> ≤ 0.8 V; 0 mA ≤ I<sub>Off</sub> ≤ 0.1 mA;  
 Typical values: T<sub>amb</sub> = 25 °C; V<sub>CC</sub> = 5.0 V; I<sub>Fon</sub> = 3.0 mA unless otherwise specified

Parameter	Test condition	Symbol	Min	Typ.	Max	Unit
Logic low output voltage	I <sub>OL</sub> = 6.4 mA	V <sub>OL</sub>			0.5	V
Logic high output voltage (except SFH6705)	I <sub>OH</sub> = 2.6 mA, V <sub>OH</sub> = V <sub>CC</sub> -1.8 V		2.4			V
Output leakage current (V <sub>OUT</sub> >V <sub>CC</sub> ) (except SFH6705)	V <sub>O</sub> = 5.5 V, V <sub>CC</sub> = 4.5 V, I <sub>F</sub> = 5.0 mA	I <sub>OHH</sub>		0.5	100	μA
	V <sub>O</sub> = 15 V, V <sub>CC</sub> = 4.5 V, I <sub>F</sub> = 5.0 mA	I <sub>OHH</sub>		1.0	500	μA
Output leakage current (SFH705 only)	V <sub>O</sub> = 5.5 V, V <sub>CC</sub> = 5.5 V, I <sub>F</sub> = 5.0 mA	I <sub>OHH</sub>		0.5	100	μA
	V <sub>O</sub> = 15 V, V <sub>CC</sub> = 15 V, I <sub>F</sub> = 5.0 mA	I <sub>OHH</sub>		1.0	500	μA
Logic high enable voltage (SFH6700/19 only)		V <sub>EH</sub>	2.0			V
Logic low enable voltage (SFH6700/19 only)		V <sub>EL</sub>			0.8	V
Logic high enable current (SFH6700/19 only)	V <sub>EN</sub> = 2.7 V	I <sub>EH</sub>			20	μA
	V <sub>EN</sub> = 5.5 V	I <sub>EH</sub>			100	μA
	V <sub>EN</sub> = 15 V	I <sub>EH</sub>		0.001	250	μA
Logic low enable current (SFH6700/19 only)	V <sub>EN</sub> = 0.4 V	I <sub>EL</sub>	- 320	- 50		μA
High impedance state output current (SFH6700/19 only)	V <sub>O</sub> = 0.4 V, V <sub>EN</sub> = 2.0 V, I <sub>F</sub> = 5.0 mA	I <sub>OZL</sub>	- 20			μA
	V <sub>O</sub> = 2.4 V, V <sub>EN</sub> = 2.0 V, I <sub>F</sub> = 0 mA	I <sub>OZH</sub>			20	μA
	V <sub>O</sub> = 5.5 V, V <sub>EN</sub> = 2.0 V, I <sub>F</sub> = 0 mA	I <sub>OZH</sub>			100	μA
		I <sub>OZH</sub>		0.001	500	μA
Logic low supply current	V <sub>CC</sub> = 5.5 V, I <sub>F</sub> = 0	I <sub>CCL</sub>		3.7	6.0	mA
	V <sub>CC</sub> = 15 V, I <sub>F</sub> = 0	I <sub>CCL</sub>		4.1	6.5	mA
Logic high supply current	V <sub>CC</sub> = 5.5 V, I <sub>F</sub> = 5.0 mA	I <sub>CCH</sub>		3.4	4.0	mA
	V <sub>CC</sub> = 15V, I <sub>F</sub> = 5.0 mA	I <sub>CCH</sub>		3.7	5.0	mA
Logic low short circuit output current <sup>2)</sup>	V <sub>O</sub> = V <sub>CC</sub> = 5.5 V, I <sub>F</sub> = 0	I <sub>OSL</sub>	25			mA
	V <sub>O</sub> = V <sub>CC</sub> = 15 V, I <sub>F</sub> = 0	I <sub>OSL</sub>	40			mA
Logic high short circuit output current <sup>2)</sup>	V <sub>CC</sub> = 5.5 V, V <sub>O</sub> = 0 V, I <sub>F</sub> = 5.0 mA	I <sub>OSL</sub>			- 10	mA
	V <sub>CC</sub> = 15 V, V <sub>O</sub> = 0 V, I <sub>F</sub> = 5.0 mA	I <sub>OSL</sub>			- 25	mA
Thermal resistance		R <sub>thja</sub>		300		K/W

<sup>2)</sup> Output short circuit time ≤ 10ms.

### Coupler

$0\text{ }^{\circ}\text{C} \leq T_{\text{amb}} \leq 85\text{ }^{\circ}\text{C}$ ;  $4.5\text{ V} \leq V_{\text{CC}} \leq 15\text{ V}$ ;  $1.6\text{ mA} \leq I_{\text{Fon}} \leq 5.0\text{ mA}$ ;  $2.0 \leq V_{\text{EH}} \leq 15\text{ V}$ ;  $0 \leq V_{\text{EL}} \leq 0.8\text{ V}$ ;  $0\text{ mA} \leq I_{\text{Foff}} \leq 0.1\text{ mA}$ ;  
 Typical values:  $T_{\text{amb}} = 25\text{ }^{\circ}\text{C}$ ;  $V_{\text{CC}} = 5.0\text{ V}$ ;  $I_{\text{Fon}} = 3.0\text{ mA}$  unless otherwise specified

Parameter	Test condition	Symbol	Min	Typ.	Max	Unit
Capacitance (input-output)	$f = 1.0\text{ MHz}$ , pins 1-4 and 5-8 shorted together	$C_{\text{IO}}$		0.6		pF
Isolation resistance	$V_{\text{IO}} = 500\text{ V}$ , $T_{\text{amb}} = 25\text{ }^{\circ}\text{C}$	$R_{\text{IO}}$	$10^{12}$			$\Omega$
	$V_{\text{IO}} = 500\text{ V}$ , $T_{\text{amb}} = 100\text{ }^{\circ}\text{C}$	$R_{\text{IO}}$	$10^{11}$			$\Omega$

### Switching Characteristics

$0\text{ }^{\circ}\text{C} \leq T_{\text{amb}} \leq 85\text{ }^{\circ}\text{C}$ ;  $4.5\text{ V} \leq V_{\text{CC}} \leq 15\text{ V}$ ;  $1.6\text{ mA} \leq I_{\text{Fon}} \leq 5.0\text{ mA}$ ;  $2.0 \leq V_{\text{EH}} \leq 15\text{ V}$  (SFH6700/19);  $0 \leq V_{\text{EL}} \leq 0.8\text{ V}$  (SFH6700/19);  $0\text{ mA} \leq I_{\text{Foff}} \leq 0.1\text{ mA}$

Typical values:  $T_{\text{amb}} = 25\text{ }^{\circ}\text{C}$ ;  $V_{\text{CC}} = 5.0\text{ V}$ ;  $I_{\text{Fon}} = 3.0\text{ mA}$  unless otherwise specified. <sup>(3)</sup>

Parameter	Test condition	Symbol	Min	Typ.	Max	Unit
Propagation delay time to logic low output level, SFH6700/01/02/11/12/19	Without peaking capacitor	$t_{\text{PHL}}$		120		ns
	With peaking capacitor	$t_{\text{PHL}}$		115	300	ns
		$t_{\text{PLH}}$		125		ns
		$t_{\text{PLH}}$		90	300	ns
Output enable time to logic high (SFH6700/19)		$t_{\text{PZH}}$		20		ns
Output enable time to logic low (SFH6700/19)		$t_{\text{PZL}}$		25		ns
Output disable time from logic low (SFH6700/19)		$t_{\text{PLZ}}$		50		ns
Output rise time	10 % to 90 %	$t_{\text{r}}$		40		ns
Output fall time	90 % to 10 %	$t_{\text{f}}$		10		ns

<sup>(3)</sup> A 0.1  $\mu\text{F}$  bypass capacitor connected between pins 5 and 8 must be used

Typical values:  $T_{\text{amb}} = 25\text{ }^{\circ}\text{C}$ ;  $V_{\text{CC}} = 5.0\text{ V}$ ;  $I_{\text{Fon}} = 3.0\text{ mA}$ ;  $R_{\text{L}} = 390\text{ }\Omega$  unless otherwise specified <sup>(3)</sup>

Parameter	Test condition	Part	Symbol	Min	Typ.	Max	Unit
Propagation delay time to logic low output level	Without peaking capacitor	SFH6705	$t_{\text{PHL}}$		115		ns
	With peaking capacitor	SFH6705	$t_{\text{PHL}}$		105	300	ns
	Without peaking capacitor	SFH6705	$t_{\text{PLH}}$		125		ns
	With peaking capacitor	SFH6705	$t_{\text{PLH}}$		90	300	ns
Output rise time	10 % to 90 %		$t_{\text{r}}$		25		ns
	90 % to 10 %		$t_{\text{f}}$		4		ns

## Common Mode Transient Immunity

$T_{amb} = 25\text{ }^{\circ}\text{C}$ ,  $V_{CC} = 5.0\text{ V}$  <sup>(4)</sup>

Parameter	Test condition	Part	Symbol	Min	Typ.	Max	Unit
Logic High Common Mode Transient Immunity	$ V_{CM}  = 50\text{ V}$ , $I_F = 1.6\text{ mA}$	SFH6700	$ICM_H$ <sup>(4)</sup>	1000			V/ $\mu$ s
		SFH6701	$ICM_H$ <sup>(4)</sup>	1000			V/ $\mu$ s
		SFH6702	$ICM_H$ <sup>(4)</sup>	1000			V/ $\mu$ s
		SFH6705	$ICM_H$ <sup>(4)</sup>	1000			V/ $\mu$ s
	$ V_{CM}  = 400\text{ V}$ , $I_F = 1.6\text{ mA}$	SFH6711	$ICM_H$ <sup>(4)</sup>	2500			V/ $\mu$ s
		SFH6712	$ICM_H$ <sup>(4)</sup>	2500			V/ $\mu$ s
SFH6719		$ICM_H$ <sup>(4)</sup>	2500			V/ $\mu$ s	
Logic Low Common Mode Transient Immunity	$ V_{CM}  = 50\text{ V}$ , $I_F = 0\text{ mA}$	SFH6700	$ICM_L$ <sup>(4)</sup>	1000			V/ $\mu$ s
		SFH6701	$ICM_L$ <sup>(4)</sup>	1000			V/ $\mu$ s
		SFH6702	$ICM_L$ <sup>(4)</sup>	1000			V/ $\mu$ s
		SFH6705	$ICM_L$ <sup>(4)</sup>	1000			V/ $\mu$ s
	$ V_{CM}  = 400\text{ V}$ , $I_F = 0\text{ mA}$	SFH6711	$ICM_L$ <sup>(4)</sup>	2500			V/ $\mu$ s
		SFH6712	$ICM_L$ <sup>(4)</sup>	2500			V/ $\mu$ s
SFH6719		$ICM_L$ <sup>(4)</sup>	2500			V/ $\mu$ s	

<sup>(4)</sup>  $CM_H$  is the maximum slew rate of a common mode voltage  $V_{CM}$  at which the output voltage remains at logic high level ( $V_O > 2.0\text{ V}$ )  
 $CM_L$  is the maximum slew rate of a common mode voltage  $V_{CM}$  at which the output voltage remains at logic high level ( $V_O < 0.8\text{ V}$ )

## Typical Characteristics ( $T_{amb} = 25\text{ }^{\circ}\text{C}$ unless otherwise specified)

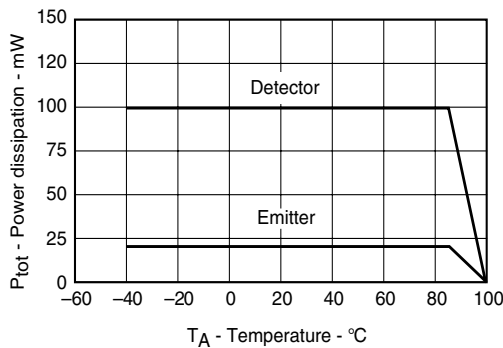

isfh6700\_02

Fig. 2 Permissible Total Power Dissipation vs. Temperature

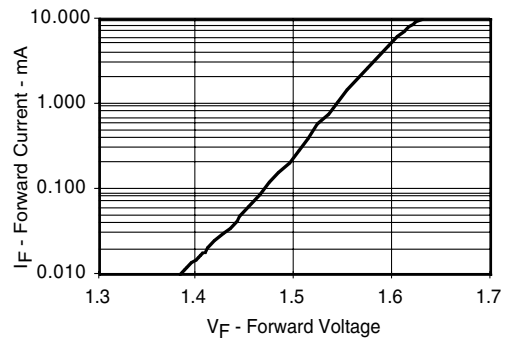

isfh6700\_03

Fig. 3 Typical Input Diode Forward Current vs. Forward Voltage

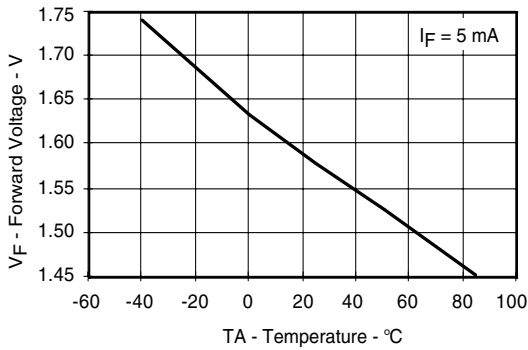

isfh6700\_04

Fig. 4 Typical Forward Input Voltage vs. Temperature

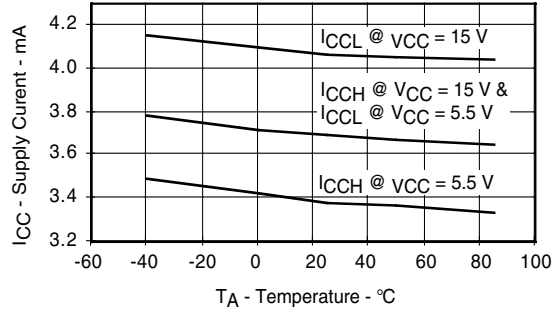

isfh6700\_07

Fig. 7 Typical Supply Current vs. Temperature

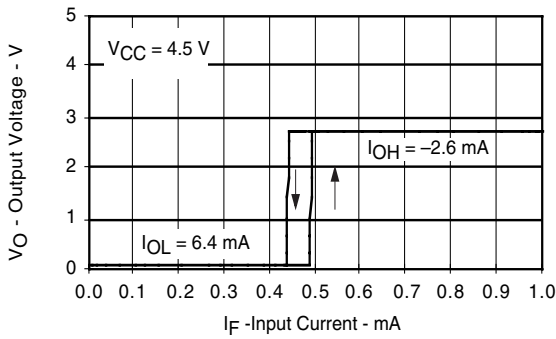

isfh6700\_05

Fig. 5 Typical Output Voltage vs. Forward Input Current (except SFH6705)

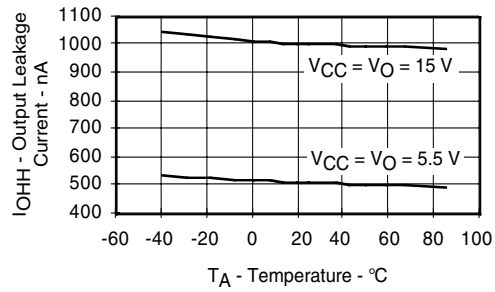

isfh6700\_08

Fig. 8 Typical Output Leakage Current vs. Temperature

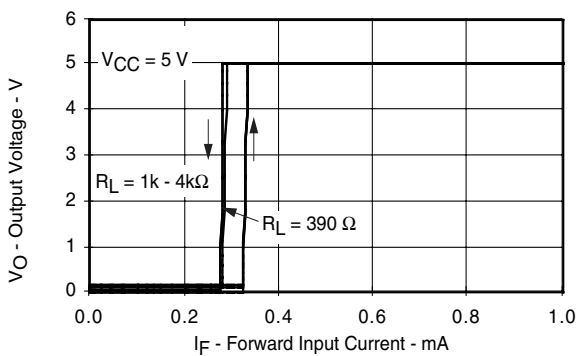

isfh6700\_06

Fig. 6 Typical Output Forward Voltage vs. Forward Input Current (only SFH6705)

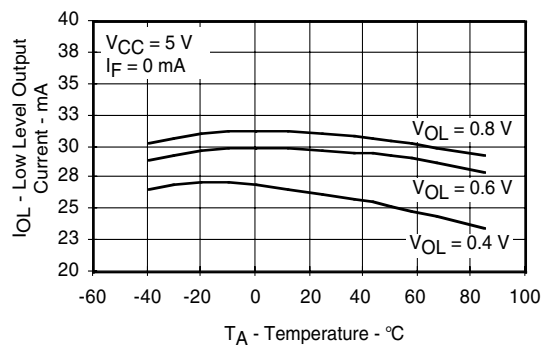

isfh6700\_09

Fig. 9 Typical Low Level Output Current vs. Temperature

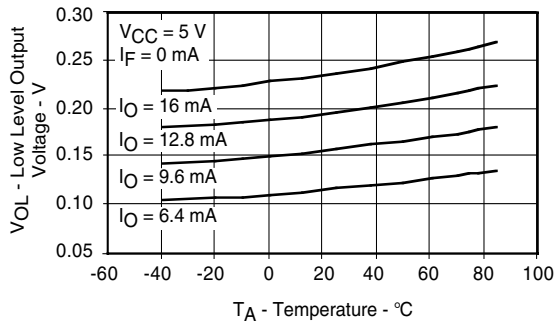

isfh6700\_10

Fig. 10 Typical Low Level Output Voltage vs. Temperature

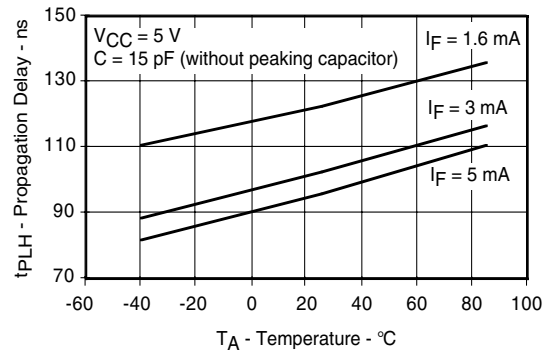

isfh6700\_24

Fig. 13 Typical Propagation Delay to Logic High vs. Temperature (except SFH6705)

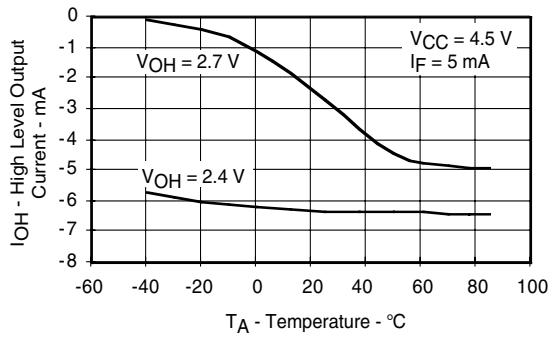

isfh6700\_11

Fig. 11 Typical High Level Output Current vs. Temperature (except SFH6705)

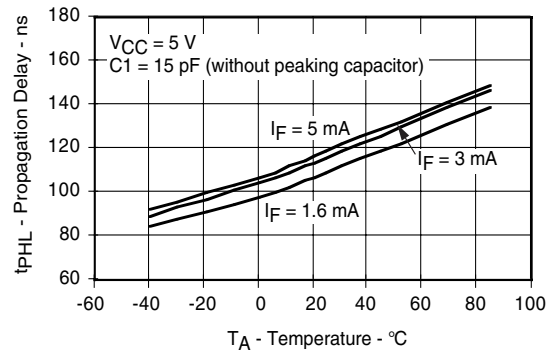

isfh6700\_14

Fig. 14 Typical Propagation Delay to Logic Low vs. Temperature (except SFH6705)

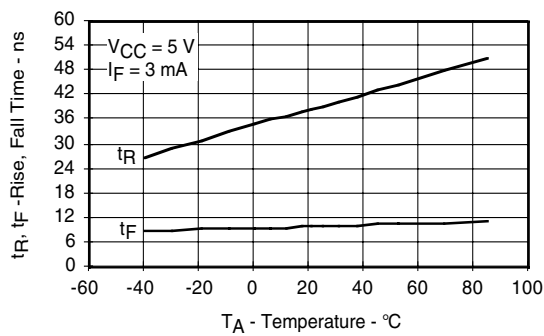

isfh6700\_12

Fig. 12 Typical Rise, Fall Time vs. Temperature (except SFH6705)

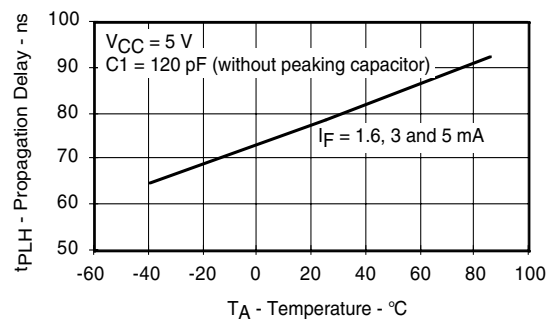

isfh6700\_15

Fig. 15 Typical Propagation Delays to Logic High vs. Temperature (except SFH6705)

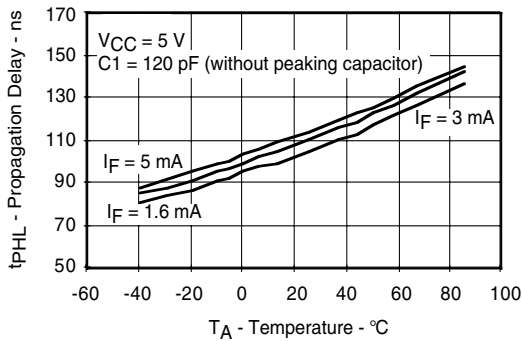

isfh6700\_16

Fig. 16 Typical Propagation Delay to Logic Low vs. Temperature

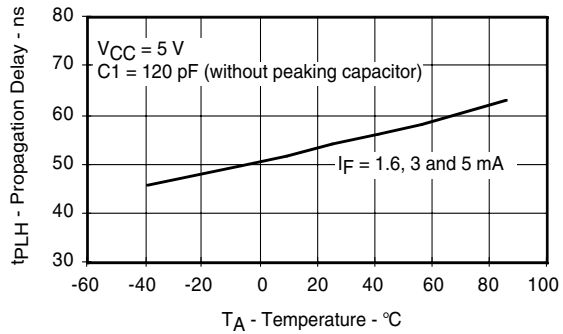

isfh6700\_19

Fig. 19 Typical Propagation Delays to Logic High vs. Temperature

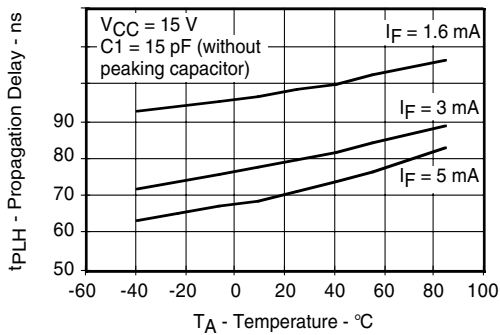

isfh6700\_17

Fig. 17 Typical Propagation Delays to Logic High vs. Temperature

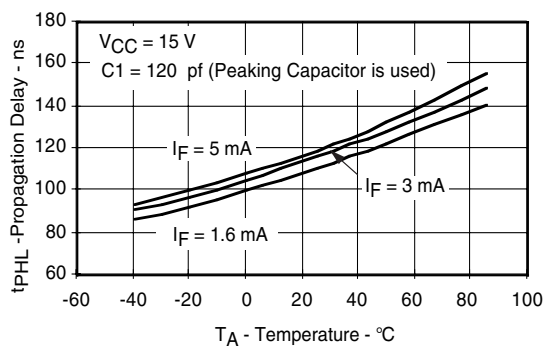

isfh6700\_20

Fig. 20 Typical propagation delays to Logic Low vs. temperature (except SFH6705)

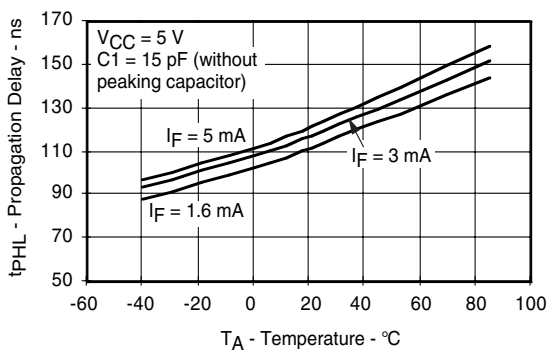

isfh6700\_18

Fig. 18 Typical Propagation Delays to Logic Low vs. Temperature

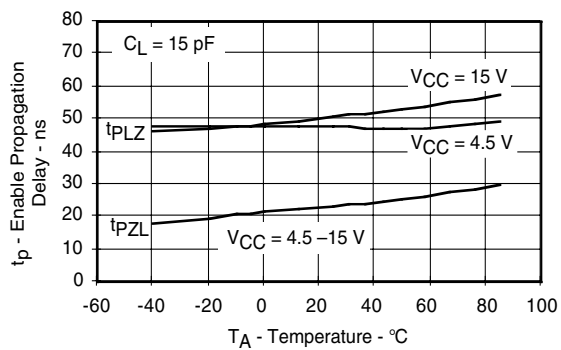

isfh6700\_21

Fig. 21 Typical Logic Low Enable Propagation Delays vs. Temperature (only SFH6700/11)

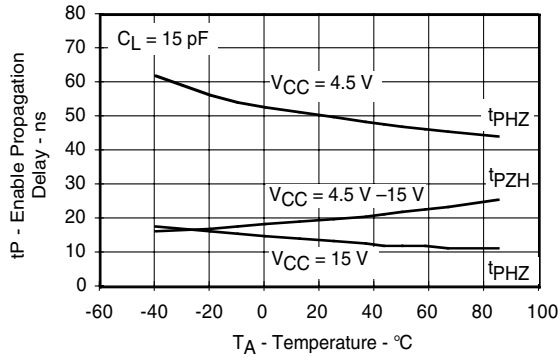

isfh6700\_22

Fig. 22 Typical Logic High Enable Propagation Delays vs. Temperature (only SFH6700/11)

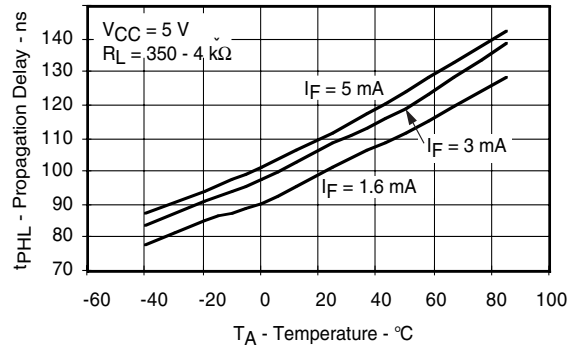

isfh6700\_25

Fig. 25 Typical Propagation Delays to Low Level vs. Temperature (only SFH6705)

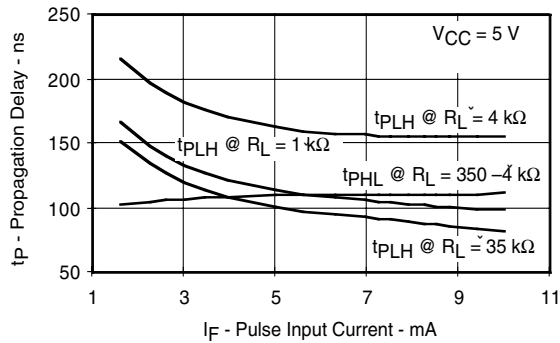

isfh6700\_23

Fig. 23 Typical Propagation Delays vs. Pulse Input Current (only SFH6705)

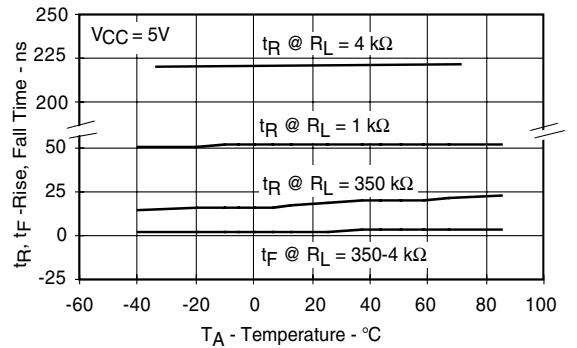

isfh6700\_26

Fig. 26 Typical Rise, Fall Time vs. Temperature (only SFH6705)

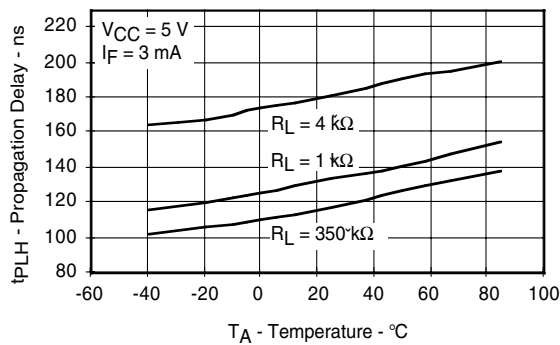

isfh6700\_24

Fig. 24 Typical Propagation Delays to High Level vs. Temperature (only SFH6705)

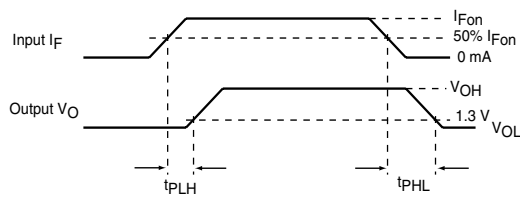
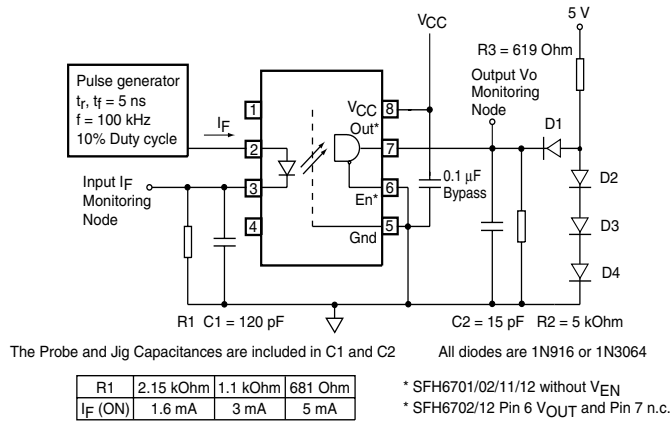

Fig. 27 Test Circuit for  $t_{PLH}$ ,  $t_{PHL}$ ,  $t_r$  and  $t_f$

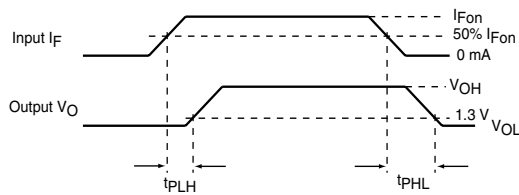
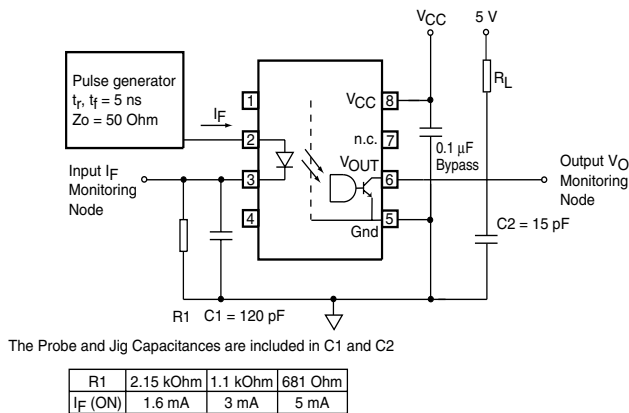

Fig. 28 Test Circuit for  $t_{PLH}$ ,  $t_{PHL}$ ,  $t_r$  and - SFH6705

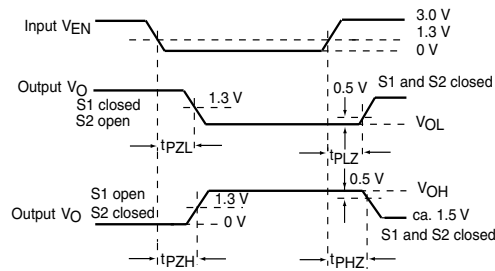
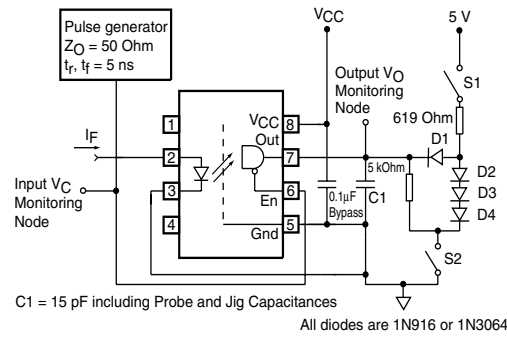

Fig. 29 Test Circuit for  $t_{PHZ}$ ,  $t_{PZH}$ ,  $t_{PLZ}$  and  $t_{PZL}$ -SFH6700/19

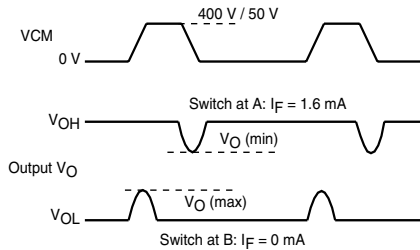
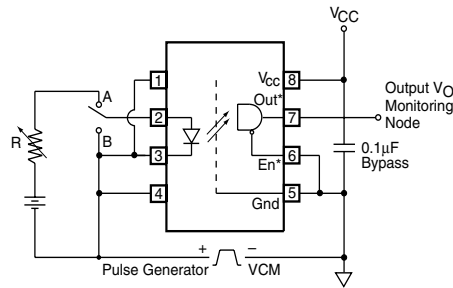

Fig. 30 Test Circuit for Common Mode Transient Immunity and Typical Waveforms-SFH6700/01/02/11/12/19

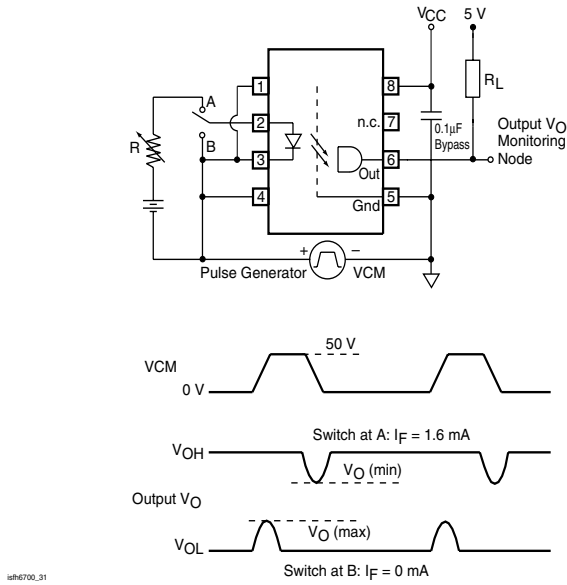
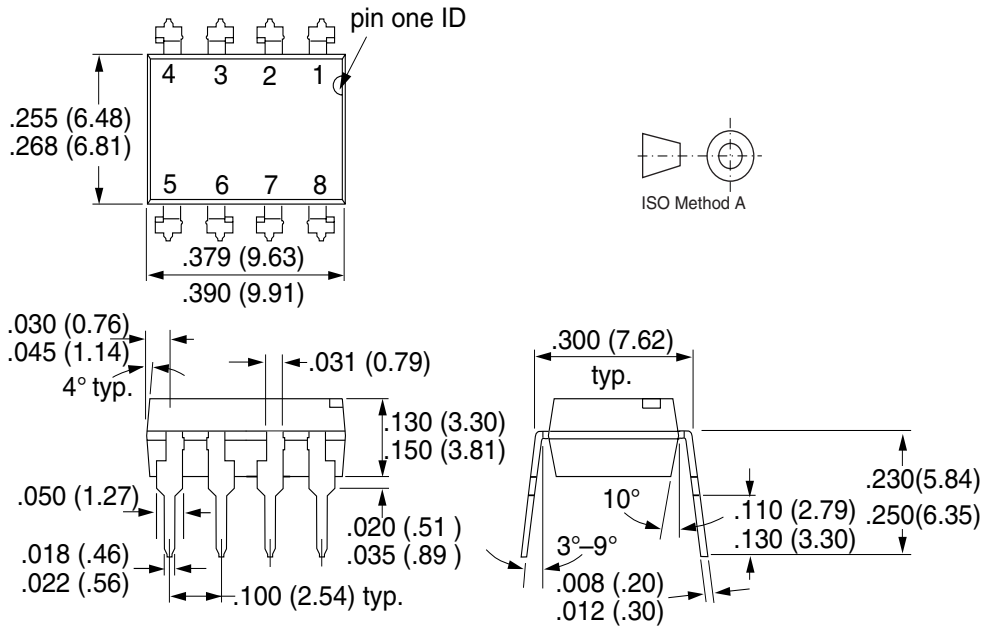
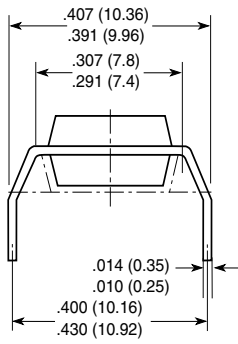

Fig. 31 Test Circuit for Common Mode Transient Immunity and Typical Waveforms-SFH6705

## Package Dimensions in Inches (mm)



**Option 6**



**Option 7**

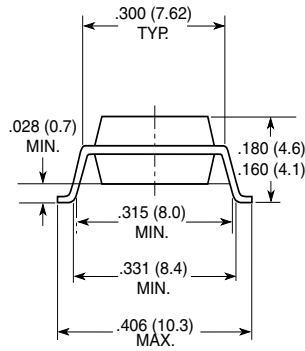

**Option 9**

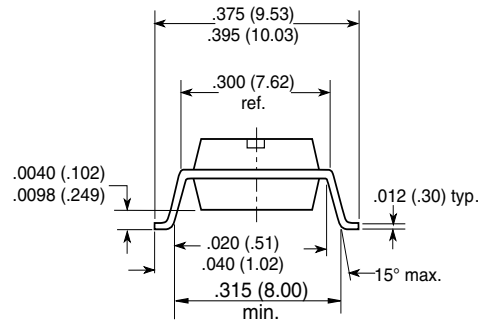

18450

### Ozone Depleting Substances Policy Statement

It is the policy of **Vishay Semiconductor GmbH** to

1. Meet all present and future national and international statutory requirements.
2. Regularly and continuously improve the performance of our products, processes, distribution and operating systems with respect to their impact on the health and safety of our employees and the public, as well as their impact on the environment.

It is particular concern to control or eliminate releases of those substances into the atmosphere which are known as ozone depleting substances (ODSs).

The Montreal Protocol (1987) and its London Amendments (1990) intend to severely restrict the use of ODSs and forbid their use within the next ten years. Various national and international initiatives are pressing for an earlier ban on these substances.

**Vishay Semiconductor GmbH** has been able to use its policy of continuous improvements to eliminate the use of ODSs listed in the following documents.

1. Annex A, B and list of transitional substances of the Montreal Protocol and the London Amendments respectively
2. Class I and II ozone depleting substances in the Clean Air Act Amendments of 1990 by the Environmental Protection Agency (EPA) in the USA
3. Council Decision 88/540/EEC and 91/690/EEC Annex A, B and C (transitional substances) respectively.

**Vishay Semiconductor GmbH** can certify that our semiconductors are not manufactured with ozone depleting substances and do not contain such substances.

**We reserve the right to make changes to improve technical design  
and may do so without further notice.**

Parameters can vary in different applications. All operating parameters must be validated for each customer application by the customer. Should the buyer use Vishay Semiconductors products for any unintended or unauthorized application, the buyer shall indemnify Vishay Semiconductors against all claims, costs, damages, and expenses, arising out of, directly or indirectly, any claim of personal damage, injury or death associated with such unintended or unauthorized use.

Vishay Semiconductor GmbH, P.O.B. 3535, D-74025 Heilbronn, Germany  
Telephone: 49 (0)7131 67 2831, Fax number: 49 (0)7131 67 2423