

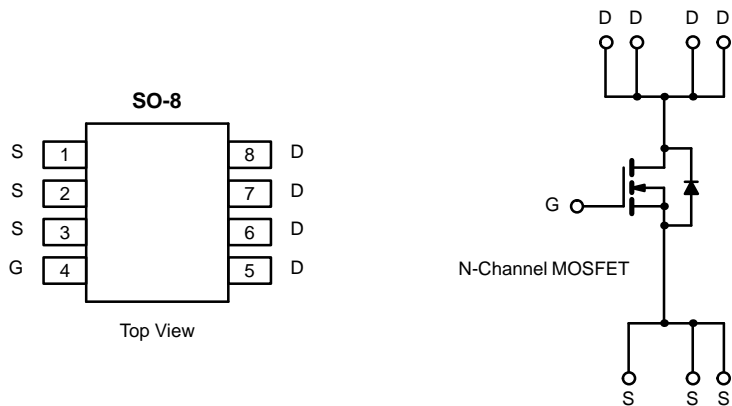

N-Channel Reduced Q_g , Fast Switching MOSFET

PRODUCT SUMMARY		
V_{DS} (V)	$r_{DS(on)}$ (Ω)	I_D (A)
30	0.0105 @ $V_{GS} = 10$ V	± 11
	0.0205 @ $V_{GS} = 4.5$ V	± 8

TrenchFET[®]
Power MOSFETs
High-Efficiency
PWM Optimized



ABSOLUTE MAXIMUM RATINGS ($T_A = 25^\circ\text{C}$ UNLESS OTHERWISE NOTED)			
Parameter	Symbol	Limit	Unit
Drain-Source Voltage	V_{DS}	30	V
Gate-Source Voltage	V_{GS}	± 25	
Continuous Drain Current ($T_J = 150^\circ\text{C}$) ^{a, b}	I_D	$T_A = 25^\circ\text{C}$	A
		$T_A = 70^\circ\text{C}$	
Pulsed Drain Current	I_{DM}	± 50	
Continuous Source Current (Diode Conduction) ^{a, b}	I_S	2.3	
Maximum Power Dissipation ^{a, b}	P_D	$T_A = 25^\circ\text{C}$	W
		$T_A = 70^\circ\text{C}$	
Operating Junction and Storage Temperature Range	T_J, T_{stg}	-55 to 150	$^\circ\text{C}$

THERMAL RESISTANCE RATINGS					
Parameter		Symbol	Typical	Maximum	Unit
Maximum Junction-to-Ambient (MOSFET) ^a	$t \leq 10$ sec	R_{thJA}	35	50	$^\circ\text{C/W}$
	Steady State		68	80	
Maximum Junction-to-Foot		R_{thJF}	19	25	

Notes

- a. Surface Mounted on FR4 Board.
- b. $t \leq 10$ sec.



MOSFET SPECIFICATIONS (T _J = 25 °C UNLESS OTHERWISE NOTED)						
Parameter	Symbol	Test Condition	Min	Typ	Max	Unit
Static						
Gate Threshold Voltage	V _{GS(th)}	V _{DS} = V _{GS} , I _D = 250 μA	1.0			V
Gate-Body Leakage	I _{GSS}	V _{DS} = 0 V, V _{GS} = ± 20 V			± 100	nA
Zero Gate Voltage Drain Current	I _{DSS}	V _{DS} = 24 V, V _{GS} = 0 V			1	μA
		V _{DS} = 24 V, V _{GS} = 0 V, T _J = 55 °C			5	
On-State Drain Current ^a	I _{D(on)}	V _{DS} ≥ 5 V, V _{GS} = 10 V	40			A
Drain-Source On-State Resistance ^a	r _{DS(on)}	V _{GS} = 10 V, I _D = 11 A		0.0087	0.0105	Ω
		V _{GS} = 4.5 V, I _D = 8 A		0.017	0.0205	
Forward Transconductance ^a	g _{fs}	V _{DS} = 15 V, I _D = 11 A		26		S
Diode Forward Voltage ^a	V _{SD}	I _S = 2.3 A, V _{GS} = 0 V		0.70	1.1	V
Dynamic^b						
Total Gate Charge	Q _g	V _{DS} = 15 V, V _{GS} = 5.0 V, I _D = 11 A		13.5	17	nC
Gate-Source Charge	Q _{gs}			3.9		
Gate-Drain Charge	Q _{gd}			6.0		
Turn-On Delay Time	t _{d(on)}	V _{DD} = 15 V, R _L = 15 Ω I _D ≅ 1 A, V _{GEN} = 10 V, R _G = 6 Ω		13	20	ns
Rise Time	t _r			8	12	
Turn-Off Delay Time	t _{d(off)}			45	68	
Fall Time	t _f			19	30	
Source-Drain Reverse Recovery Time	t _{rr}	I _F = 2.3 A, di/dt = 100 A/μs		40	70	

Notes

- a. Pulse test; pulse width ≤ 300 μs, duty cycle ≤ 2%.
- b. Guaranteed by design, not subject to production testing.

TYPICAL CHARACTERISTICS (25 °C UNLESS NOTED)

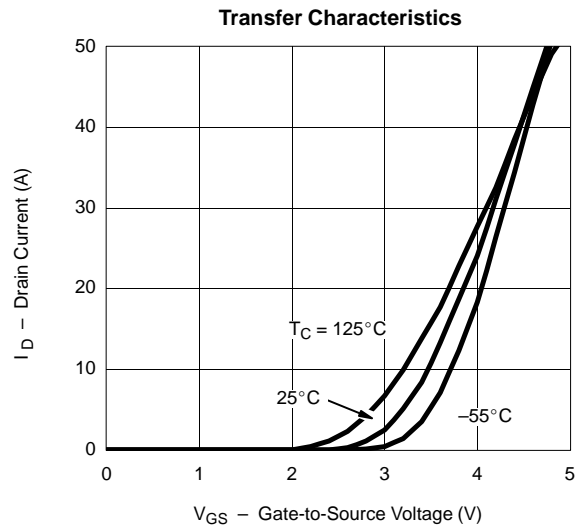
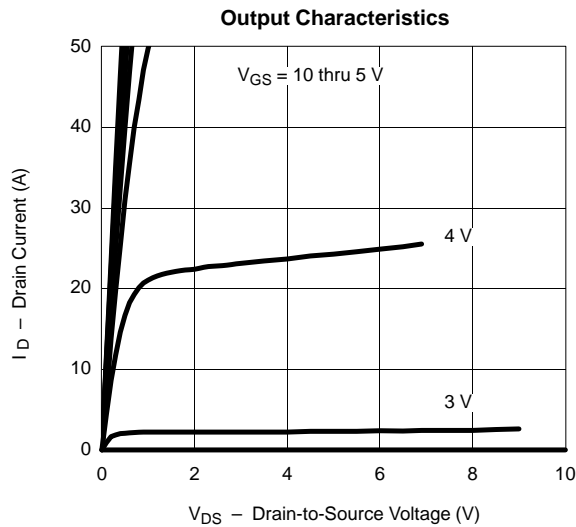



TYPICAL CHARACTERISTICS (25°C UNLESS NOTED)

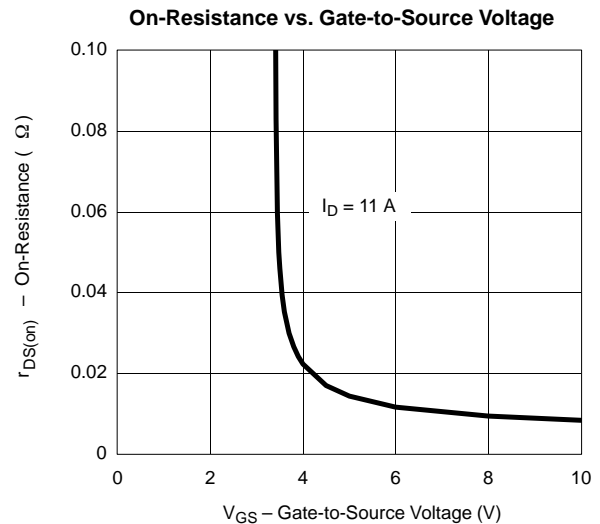
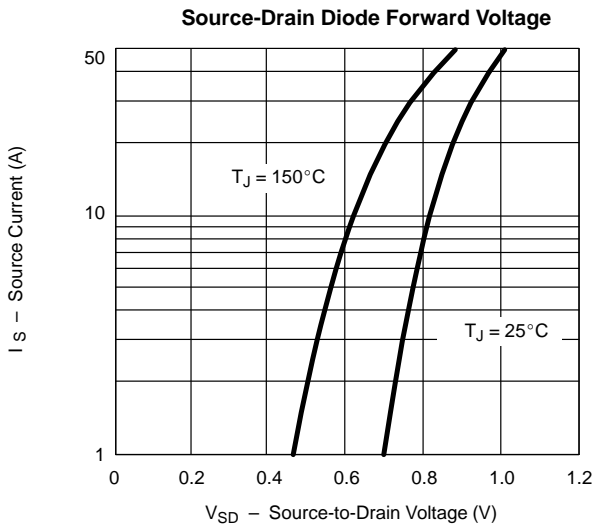
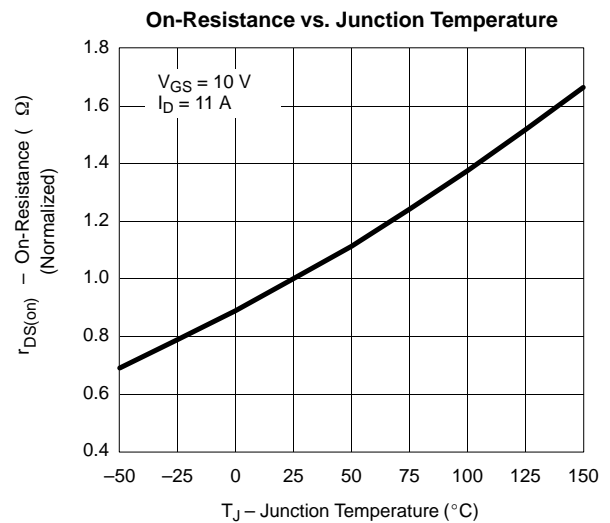
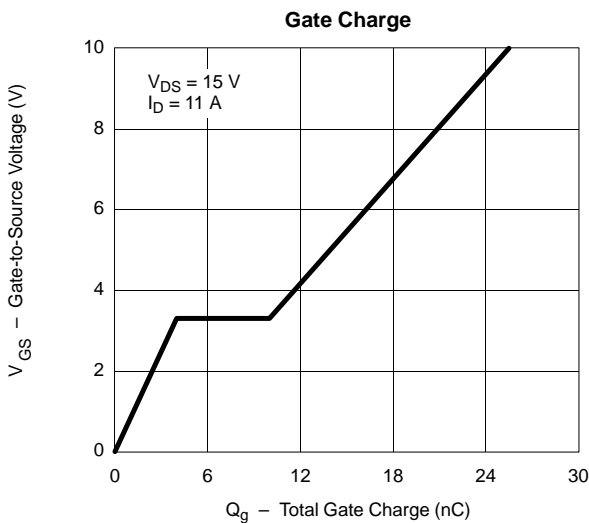
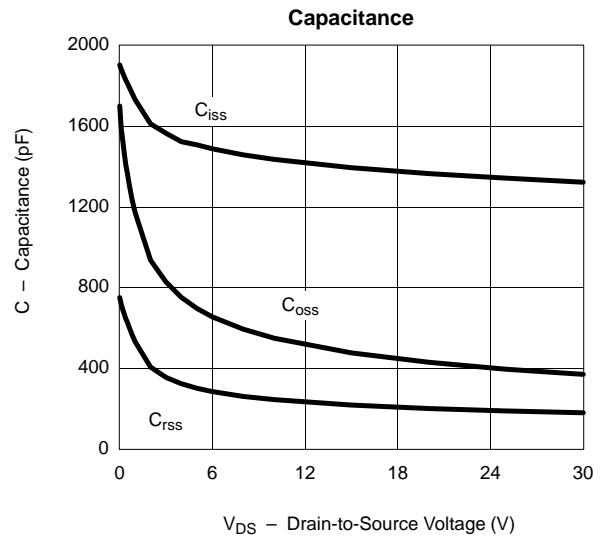
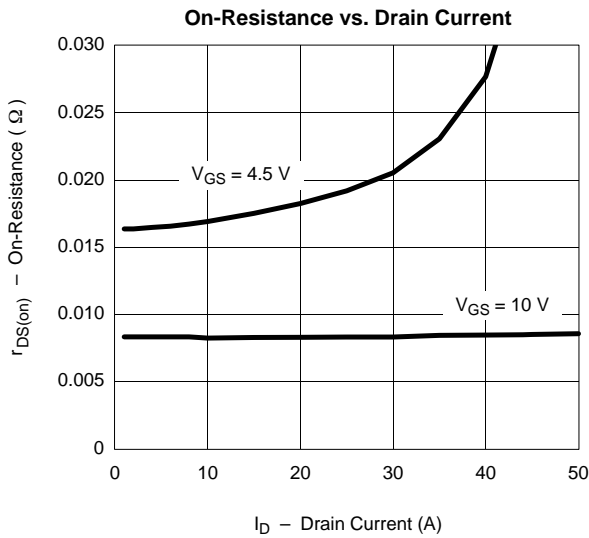



TYPICAL CHARACTERISTICS (25°C UNLESS NOTED)

