

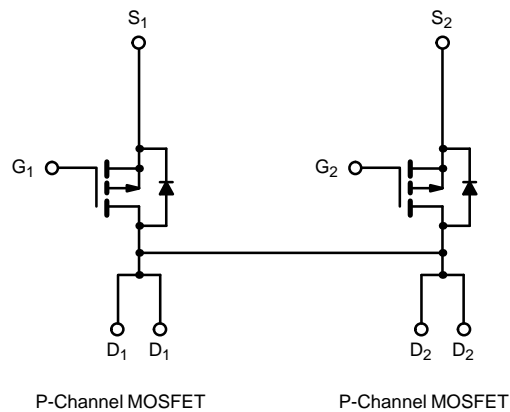

## P-Channel 30-V (D-S) Battery Switch

PRODUCT SUMMARY		
$V_{DS}$ (V)	$r_{DS(on)}$ ( $\Omega$ )	$I_D$ (A)
-30	0.028 @ $V_{GS} = -10$ V	$\pm 7.4$
	0.045 @ $V_{GS} = -4.5$ V	$\pm 5.8$

**TrenchFET®**  
Power MOSFETs

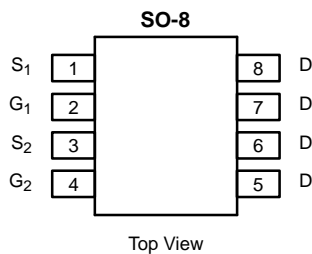

ABSOLUTE MAXIMUM RATINGS ( $T_A = 25^\circ\text{C}$ UNLESS OTHERWISE NOTED)			
Parameter	Symbol	Limit	Unit
Drain-Source Voltage	$V_{DS}$	-30	V
Gate-Source Voltage	$V_{GS}$	$\pm 20$	
Continuous Drain Current ( $T_J = 150^\circ\text{C}$ ) <sup>a, b</sup>	$I_D$	$T_A = 25^\circ\text{C}$	$\pm 7.4$
		$T_A = 70^\circ\text{C}$	$\pm 5.8$
Pulsed Drain Current	$I_{DM}$	$\pm 40$	A
Continuous Source Current (Diode Conduction) <sup>a, b</sup>	$I_S$	-2.1	
Maximum Power Dissipation <sup>a, b</sup>	$P_D$	$T_A = 25^\circ\text{C}$	2.5
		$T_A = 70^\circ\text{C}$	1.6
Operating Junction and Storage Temperature Range	$T_J, T_{stg}$	-55 to 150	$^\circ\text{C}$

THERMAL RESISTANCE RATINGS					
Parameter	Symbol	Typical	Maximum	Unit	
Maximum Junction-to-Ambient <sup>a</sup>	$R_{thJA}$		50	$^\circ\text{C/W}$	
		Steady State	75		

Notes

a. Surface Mounted on FR4 Board.

b.  $t = \leq 10$  sec.

For SPICE model information via the Worldwide Web: <http://www.vishay.com/www/product/spice.htm>



SPECIFICATIONS (T <sub>J</sub> = 25 °C UNLESS OTHERWISE NOTED)						
Parameter	Symbol	Test Condition	Min	Typ	Max	Unit
<b>Static</b>						
Gate Threshold Voltage	V <sub>GS(th)</sub>	V <sub>DS</sub> = V <sub>GS</sub> , I <sub>D</sub> = -250 μA	-1			V
Gate-Body Leakage	I <sub>GSS</sub>	V <sub>DS</sub> = 0 V, V <sub>GS</sub> = ±20 V			±100	nA
Zero Gate Voltage Drain Current	I <sub>DSS</sub>	V <sub>DS</sub> = -24 V, V <sub>GS</sub> = 0 V			-1	μA
		V <sub>DS</sub> = -24 V, V <sub>GS</sub> = 0 V, T <sub>J</sub> = 55 °C			-25	
On-State Drain Current <sup>a</sup>	I <sub>D(on)</sub>	V <sub>DS</sub> ≥ -5 V, V <sub>GS</sub> = -10 V	-30			A
Drain-Source On-State Resistance <sup>a</sup>	r <sub>DS(on)</sub>	V <sub>GS</sub> = -10 V, I <sub>D</sub> = -7.4 A		0.022	0.028	Ω
		V <sub>GS</sub> = -4.5 V, I <sub>D</sub> = -5.8 A		0.034	0.045	
Forward Transconductance <sup>a</sup>	g <sub>fs</sub>	V <sub>DS</sub> = -15 V, I <sub>D</sub> = -7.4 A		15		S
Diode Forward Voltage <sup>a</sup>	V <sub>SD</sub>	I <sub>S</sub> = -2.1 A, V <sub>GS</sub> = 0 V		-0.73	-1.2	V
<b>Dynamic<sup>b</sup></b>						
Total Gate Charge	Q <sub>g</sub>	V <sub>DS</sub> = -15 V, V <sub>GS</sub> = -10 V, I <sub>D</sub> = -7.4 A		38	60	nC
Gate-Source Charge	Q <sub>gs</sub>			8		
Gate-Drain Charge	Q <sub>gd</sub>			6.8		
Turn-On Delay Time	t <sub>d(on)</sub>	V <sub>DD</sub> = -15 V, R <sub>L</sub> = 15 Ω I <sub>D</sub> ≅ -1 A, V <sub>GEN</sub> = -10 V, R <sub>G</sub> = 6 Ω		13	25	ns
Rise Time	t <sub>r</sub>			9	20	
Turn-Off Delay Time	t <sub>d(off)</sub>			75	120	
Fall Time	t <sub>f</sub>			42	70	
Source-Drain Reverse Recovery Time	t <sub>rr</sub>	I <sub>F</sub> = -2.1 A, di/dt = 100 A/μs		50	90	

Notes

- a. Guaranteed by design, not subject to production testing.
- b. Pulse test; pulse width ≤ 300 μs, duty cycle ≤ 2%.



**TYPICAL CHARACTERISTICS (25°C UNLESS NOTED)**

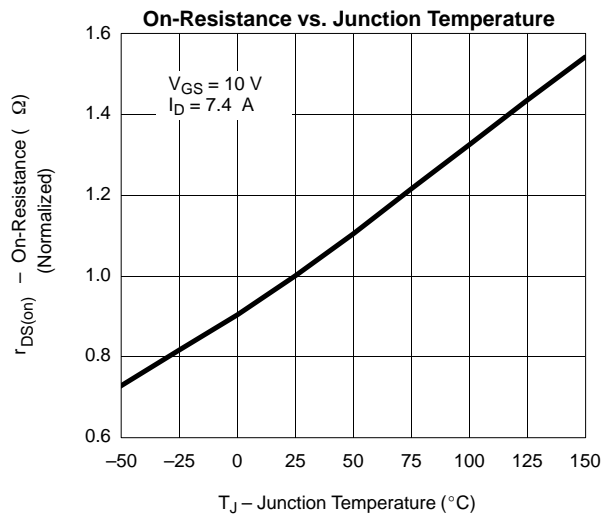
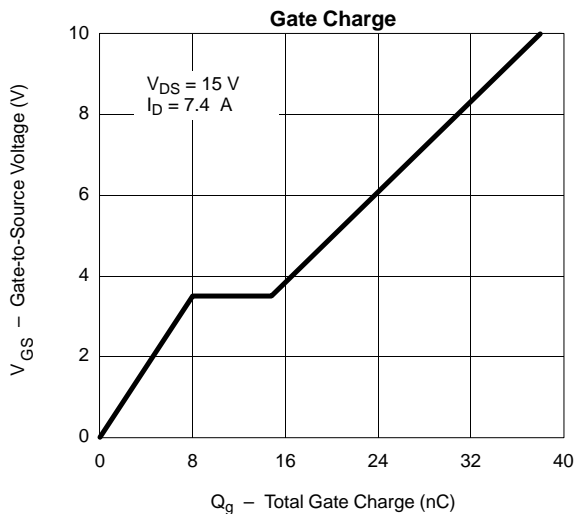
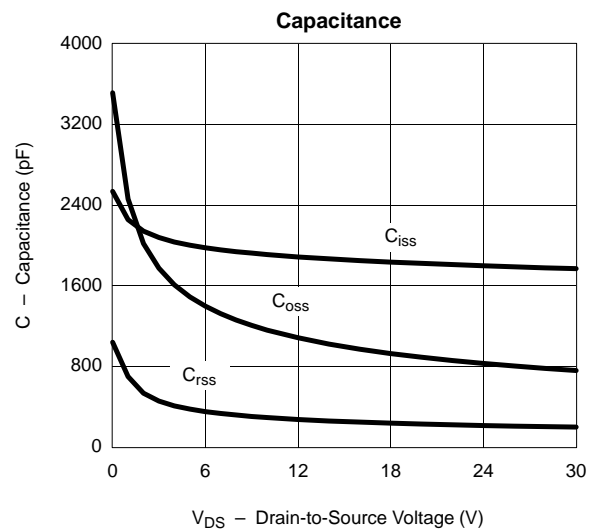
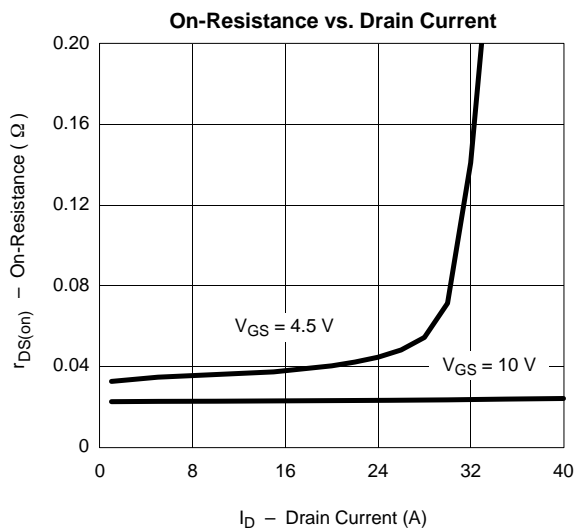
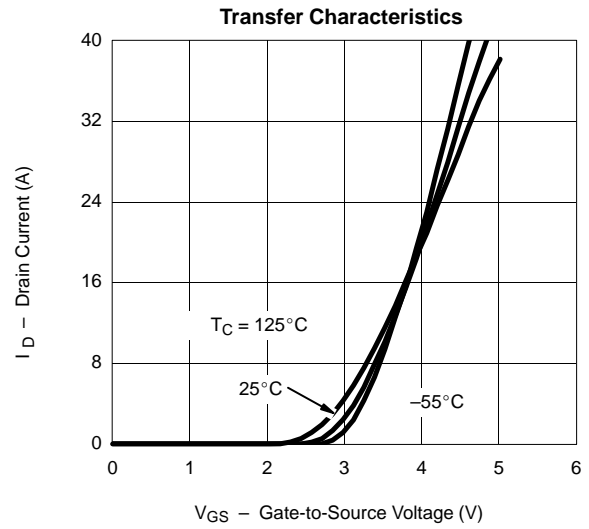
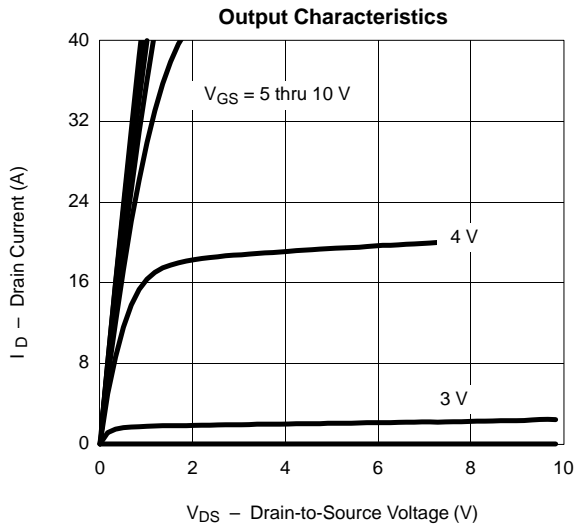

**TYPICAL CHARACTERISTICS (25°C UNLESS NOTED)**

