

N- and P-Channel Dual Enhancement-Mode MOSFET

CHARACTERISTICS

- N- and P-Channel Vertical DMOS
- Macro Model (Subcircuit Model)
- Level 3 MOS
- Apply for both Linear and Switching Application
- Accurate over the -55 to 125°C Temperature Range
- Model the Gate Charge, Transient, and Diode Reverse Recovery Characteristics

DESCRIPTION

The attached spice model describes the typical electrical characteristics of the n- and p-channel vertical DMOS. The model subcircuit schematic is extracted and optimized over the -55 to 125°C temperature ranges under the pulsed 0-to-5V gate drive. The saturated output impedance is best fit at the gate bias near the threshold voltage.

A novel gate-to-drain feedback capacitance network is used to model the gate charge characteristics while avoiding convergence difficulties of the switched C_{gd} model. All model parameter values are optimized to provide a best fit to the measured electrical data and are not intended as an exact physical interpretation of the device.

SUBCIRCUIT MODEL SCHEMATIC

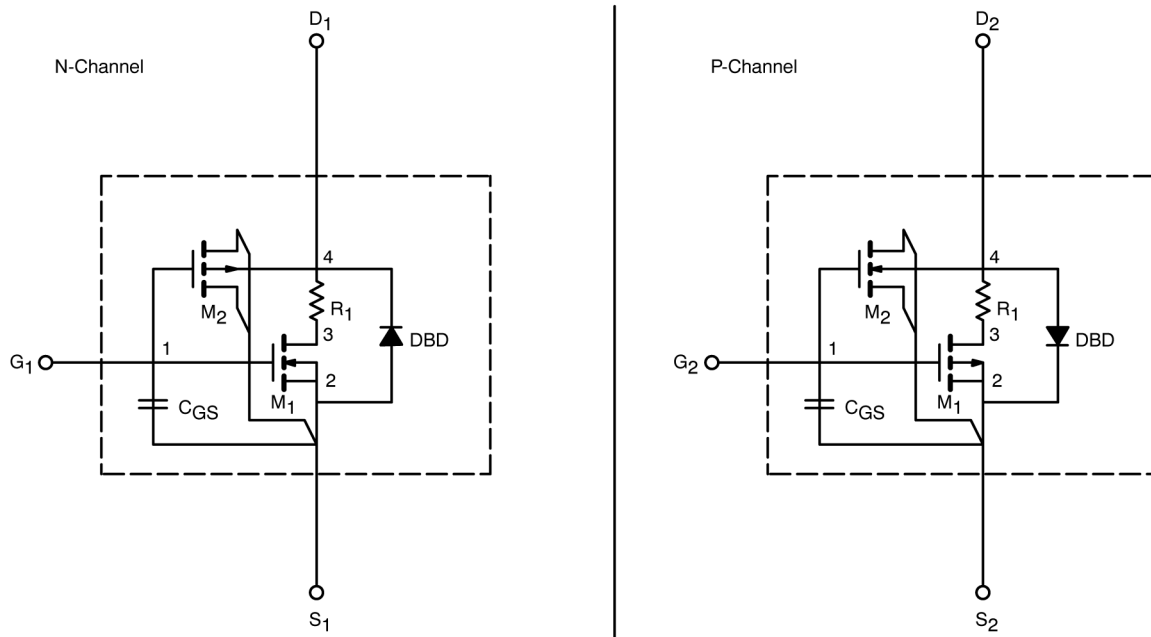

This document is intended as a SPICE modeling guideline and does not constitute a commercial product data sheet. Designers should refer to the appropriate data sheet of the same number for guaranteed specification limits.

SPICE Device Model Si6801DQ

Vishay Siliconix



SPECIFICATIONS (T _J = 25°C UNLESS OTHERWISE NOTED)						
Parameter	Symbol	Test Conditions	Typical	Unit		
Static						
Gate Threshold Voltage	V _{GS(th)}	V _{DS} = V, V _{GS} , I _D = 250 μA	N-Ch	1.02		
		V _{DS} = V, V _{GS} , I _D = -250 μA	P-Ch	1.15		
On-State Drain Current ^a	I _{D(on)}	V _{DS} 5 V, V _{GS} = 4.5 V	N-Ch	23	A	
		V _{DS} = -5 V, V _{GS} = -4.5 V	P-Ch	18		
Drain-Source On-State Resistance ^a	r _{DS(on)}	V _{GS} = 4.5 V, I _D = 1.9 A	N-Ch	0.112	Ω	
		V _{GS} = -4.5 V, I _D = -1.7 A	P-Ch	0.154		
		V _{GS} = 3 V, I _D = 1.5 A	N-Ch	0.149		
		V _{GS} = -3 V, I _D = -1.3 A	P-Ch	0.217		
Forward Transconductance ^a	g _{fs}	V _{DS} = 15 V, I _D = 1.9 A	N-Ch	5	S	
		V _{DS} = -15 V, I _D = -1.7 A	P-Ch	4.1		
Diode Forward Voltage ^a	V _{SD}	I _S = 1 A, V _{GS} = 0 V	N-Ch	0.77	V	
		I _S = -1 V, V _{GS} = 0 V	P-Ch	-0.77		
Dynamic^b						
Total Gate Charge	Q _g	N-Channel V _{DS} = 3.5 V, V _{GS} = 4.5 V, I _D = 0.3 A P-Channel V _{DS} = -3.5 V, V _{GS} = -4.5 V, I _D = -0.3 A	N-Ch	1.6	nC	
			P-Ch	3		
Gate-Source Charge	Q _{gs}		N-Ch	0.41		
			P-Ch	0.76		
Gate-Drain Charge	Q _{gd}		N-Ch	0.26		
			P-Ch	0.70		
Turn-On Delay Time	t _{d(on)}		N-Ch	5.2		ns
			P-Ch	6		
Rise Time	t _r		N-Ch	6.2		
			P-Ch	10		
Turn-Off Delay Time	t _{d(off)}	N-Ch	9			
		P-Ch	11			
Fall Time	t _f	N-Ch	15			
		P-Ch	22			
Source-Drain Reverse Recovery Time	t _{rr}	I _F = 1 A, di/dt = 100 A/μs	N-Ch	31		
		I _F = -1 A, di/dt = 100 A/μs	P-Ch	30		

Notes

a. Guaranteed by design, not subject to production testing.

b. Pulse test; pulse width ≤ 300 μs, duty cycle ≤ 2%.



COMPARISON OF MODEL WITH MEASURED DATA (T_J=25°C UNLESS OTHERWISE NOTED)

N-CHANNEL MOSFET

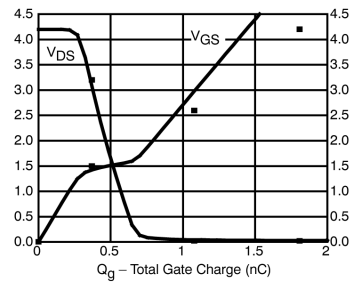
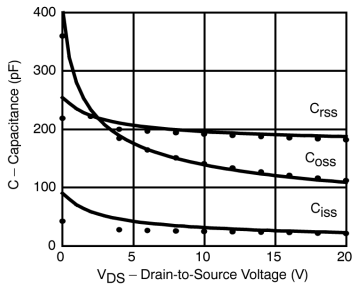
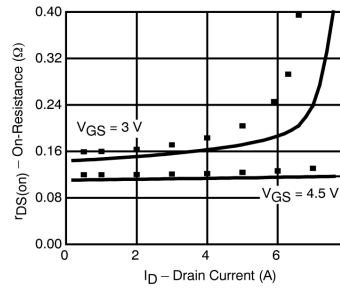
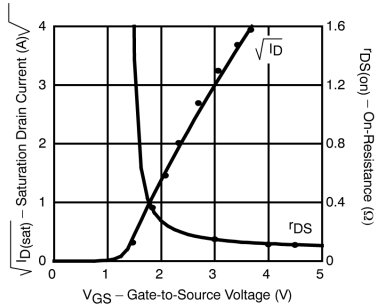
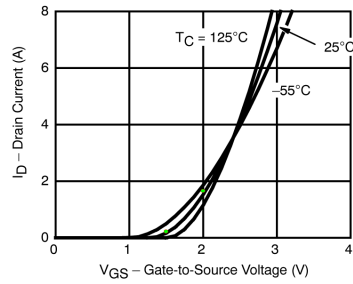
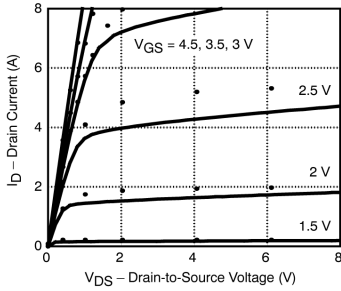

Note: Dots and squares represent measured data.

SPICE Device Model Si6801DQ

Vishay Siliconix



P-CHANNEL MOSFET

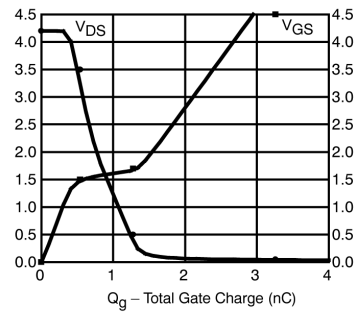
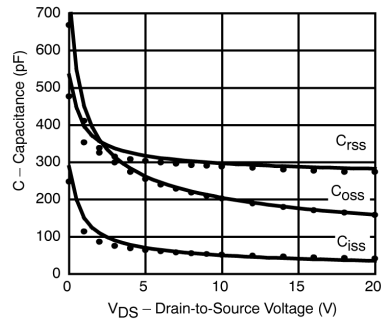
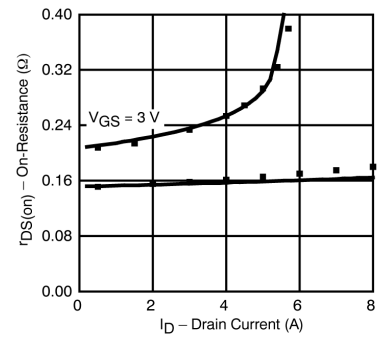
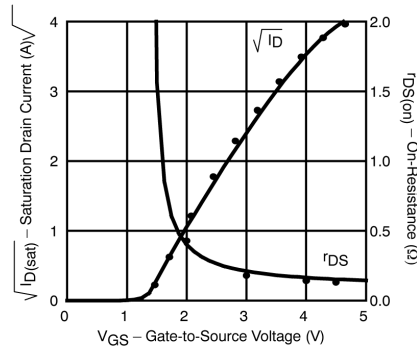
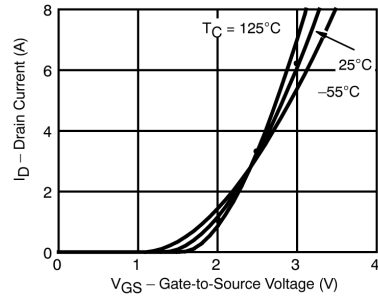
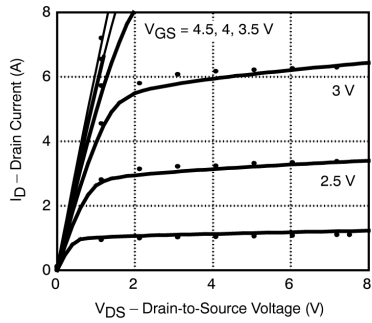

Note: Dots and squares represent measured data.