

Vishay Siliconix

ABSOLUTE MAXIMUM RATINGS

| | |
|-----------------------------------------------------------------------------|--------------------------------------------|
| Voltages Referenced to $-V_{IN}$ (Note: $V_{CC} < +V_{IN} + 0.3\text{ V}$) | |
| V_{CC} | 15 V |
| $+V_{IN}$ | 120 V |
| Logic Inputs (RESET, SHUTDOWN, OSC IN, OSC OUT) | -0.3 V to $V_{CC} + 0.3\text{ V}$ |
| Linear Inputs (FEEDBACK, SENSE, BIAS, V_{REF}) | -0.3 V to $V_{CC} + 0.3\text{ V}$ |
| HV Pre-Regulator Input Current (continuous) | 5 mA |
| Storage Temperature | -65 to 150°C |
| Operating Temperature | -40 to 85°C |

| | |
|--------------------------------------------------|-----------------------|
| Junction Temperature (T_J) | 150°C |
| Power Dissipation (Package)a | |
| 14-Pin Plastic DIP (J Suffix) ^b | 750 mW |
| 14-Pin SOIC (Y Suffix) ^c | 900 mW |
| Thermal Impedance (Θ_{JA}) | |
| 14-Pin Plastic DIP | 167°C/W |
| 14-Pin SOIC | 140°C/W |

Notes

- Device mounted with all leads soldered or welded to PC board.
- Derate 6 mW/ $^\circ\text{C}$ above 25°C .
- Derate 7.2 mW/ $^\circ\text{C}$ above 25°C .

RECOMMENDED OPERATING RANGE

| | | | |
|----------------------------------|-----------------|----------------------|-------------------------------|
| Voltages Referenced to $-V_{IN}$ | | | |
| V_{CC} | 9.5 V to 13.5 V | R_{OSC} | 25 k Ω to 1 M Ω |
| $+V_{IN}$ | 10 V to 120 V | Linear Inputs | 0 to $V_{CC} - 3\text{ V}$ |
| f_{OSC} | 40 kHz to 1 MHz | Digital Inputs | 0 to V_{CC} |

SPECIFICATIONS^a

| Parameter | Symbol | Test Conditions Unless Otherwise Specified DISCHARGE = $-V_{IN} = 0\text{ V}$ $V_{CC} = 10\text{ V}$, $+V_{IN} = 48\text{ V}$ $R_{BIAS} = 390\text{ k}\Omega$, $R_{OSC} = 330\text{ k}\Omega$ | Temp ^b | D Suffix -40 to 85°C | | | Unit | |
|---------------------------------------|--------------|-------------------------------------------------------------------------------------------------------------------------------------------------------------------------------------------------------------|------------------------------------|-----------------------------------------|------------------|------------------|-----------------------|----|
| | | | | Min ^d | Typ ^c | Max ^d | | |
| Reference | | | | | | | | |
| Output Voltage | V_R | OSC IN = $-V_{IN}$ (OSC Disabled) $R_L = 10\text{ M}\Omega$ | Si9110 | Room | 3.92 | 4.0 | 4.08 | V |
| | | | Si9111 | Room | 3.60 | 4.0 | 4.40 | |
| | | | Si9110 | Full | 3.86 | | 4.14 | |
| | | | Si9111 | Full | 3.52 | | 4.46 | |
| Output Impedance ^e | Z_{OUT} | | Room | 15 | 30 | 45 | k Ω | |
| Short Circuit Current | I_{SREF} | $V_{REF} = -V_{IN}$ | Room | 70 | 100 | 130 | μA | |
| Temperature Stability ^e | T_{REF} | | Full | | 0.50 | 1.0 | mV/ $^\circ\text{C}$ | |
| Oscillator | | | | | | | | |
| Maximum Frequency ^e | f_{MAX} | $R_{OSC} = 0$ | Room | 1 | 3 | | MHz | |
| Initial Accuracy | f_{OSC} | $R_{OSC} = 330\text{ k}$, See Note f | Room | 80 | 100 | 120 | kHz | |
| | | $R_{OSC} = 150\text{ k}$, See Note f | Room | 160 | 200 | 240 | | |
| Voltage Stability | $\Delta f/f$ | $\Delta f/f = f(13.5\text{ V}) - f(9.5\text{ V}) / f(9.5\text{ V})$ | Room | | 10 | 15 | % | |
| Temperature Coefficient ^e | T_{OSC} | | Full | | 200 | 500 | ppm/ $^\circ\text{C}$ | |
| Error Amplifier | | | | | | | | |
| Feedback Input Voltage | V_{FB} | FB Tied to COMP OSC IN = $-V_{IN}$ (OSC Disabled) | Si9110 | Room | 3.96 | 4.00 | 4.04 | V |
| | | | Si9111 | Room | 3.60 | 4.00 | 4.40 | |
| Input BIAS Current | I_{FB} | OSC IN = $-V_{IN}$, $V_{FB} = 4\text{ V}$ | Room | | 25 | 500 | nA | |
| Input OFFSET Voltage | V_{OS} | OSC IN = $-V_{IN}$ (OSC Disabled) | Room | | ± 15 | ± 40 | mV | |
| Open Loop Voltage Gain ^e | A_{VOL} | | Room | 60 | 80 | | dB | |
| Unity Gain Bandwidth ^e | BW | | Room | 1 | 1.3 | | MHz | |
| Dynamic Output Impedance ^e | Z_{OUT} | | Room | | 1000 | 2000 | Ω | |
| Output Current | I_{OUT} | | Source ($V_{FB} = 3.4\text{ V}$) | Room | | -2.0 | -1.4 | mA |
| | | Sink ($V_{FB} = 4.5\text{ V}$) | Room | 0.12 | 0.15 | | | |
| Power Supply Rejection | PSRR | $9.5\text{ V} \leq V_{CC} \leq 13.5\text{ V}$ | Room | 50 | 70 | | dB | |



| SPECIFICATIONS^a | | | | | | | |
|----------------------------------------------------------|---------------------|-------------------------------------------------------------------------------------------------------------------------------------------------------------------------------------------------|-------------------|-------------------------|------------------|------------------|------|
| Parameter | Symbol | Test Conditions Unless Otherwise Specified DISCHARGE = -V _{IN} = 0 V V _{CC} = 10 V, +V _{IN} = 48 V R _{BIAS} = 390 kΩ, R _{Osc} = 330 kΩ | Temp ^b | D Suffix -40 to 85°C | | | Unit |
| | | | | Min ^d | Typ ^c | Max ^d | |
| Current Limit | | | | | | | |
| Threshold Voltage | V _{SOURCE} | V _{FB} = 0 V | Room | 1.0 | 1.2 | 1.4 | V |
| Delay to Output ^e | t _d | V _{SENSE} = 1.5 V, See Figure 1 | Room | | 100 | 150 | ns |
| Pre-Regulator/Start-Up | | | | | | | |
| Input Voltage | +V _{IN} | I _{IN} = 10 μA | Room | 120 | | | V |
| Input Leakage Current | +I _{IN} | V _{CC} ≥ 9.4 V | Room | | | 10 | μA |
| Pre-Regulator Start-Up Current | I _{START} | Pulse Width ≤ 300 μs, V _{CC} = V _{UVLO} | Room | 8 | 15 | | mA |
| V _{CC} Pre-Regulator Turn-Off Threshold Voltage | V _{REG} | I _{PRE-REGULATOR} = 10 μA | Room | 7.8 | 8.6 | 9.4 | V |
| Undervoltage Lockout | V _{UVLO} | | Room | 7.0 | 8.1 | 8.9 | |
| V _{REG} - V _{UVLO} | V _{DELTA} | | Room | 0.3 | 0.6 | | |
| Supply | | | | | | | |
| Supply Current | I _{CC} | C _{LOAD} < 75 pF (Pin 4) | Room | 0.45 | 0.6 | 1.0 | mA |
| Bias Current | I _{BIAS} | | Room | 10 | 15 | 20 | μA |
| Logic | | | | | | | |
| SHUTDOWN Delay ^e | t _{SD} | C _L = 500 pF, V _{SENSE} - V _{IN} , See Figure 2 | Room | | 50 | 100 | ns |
| SHUTDOWN Pulse Width ^e | t _{SW} | See Figure 3 | Room | 50 | | | |
| RESET Pulse Width ^e | t _{RW} | | Room | 50 | | | |
| Latching Pulse Width SHUTDOWN and RESET Low ^e | t _{LW} | See Figure 3 | Room | 25 | | | |
| Input Low Voltage | V _{IL} | | Room | | | 2.0 | V |
| Input High Voltage | V _{IH} | | Room | 8 | | | |
| Input Current Input Voltage High | I _{IH} | V _{IN} = 10 V | Room | | 1 | 5 | μA |
| Input Current Input Voltage Low | I _{IL} | V _{IN} = 0 V | Room | -35 | -25 | | |
| Output | | | | | | | |
| Output High Voltage | V _{OH} | I _{OUT} = -10 mA | Room Full | 9.7 9.5 | | | V |
| Output Low Voltage | V _{OL} | I _{OUT} = 10 mA | Room Full | | | 0.30 0.50 | |
| Output Resistance | R _{OUT} | I _{OUT} = 10 mA, Source or Sink | Room Full | | 20 25 | 30 50 | Ω |
| Rise Time ^e | t _r | C _L = 500 pF | Room | | 40 | 75 | ns |
| Fall Time ^e | t _f | | Room | | 40 | 75 | |

Notes

- a. Refer to PROCESS OPTION FLOWCHART for additional information.
- b. Room = 25°C, Full = as determined by the operating temperature suffix.
- c. Typical values are for DESIGN AID ONLY, not guaranteed nor subject to production testing.
- d. The algebraic convention whereby the most negative value is a minimum and the most positive a maximum.
- e. Guaranteed by design, not subject to production test.
- f. C_{STRAY} Pin 8 = ≤ 5 pF.

TIMING WAVEFORMS

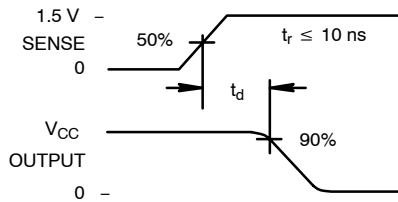

FIGURE 1.

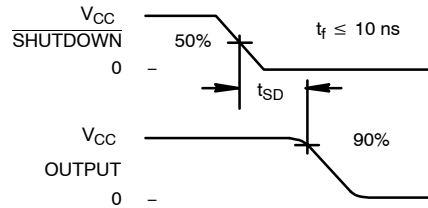

FIGURE 2.

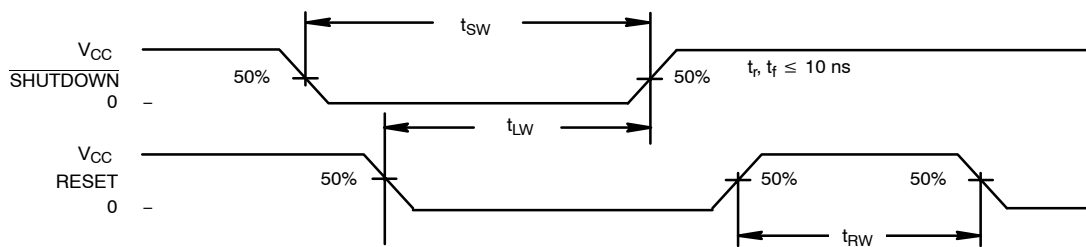

FIGURE 3.

TYPICAL CHARACTERISTICS

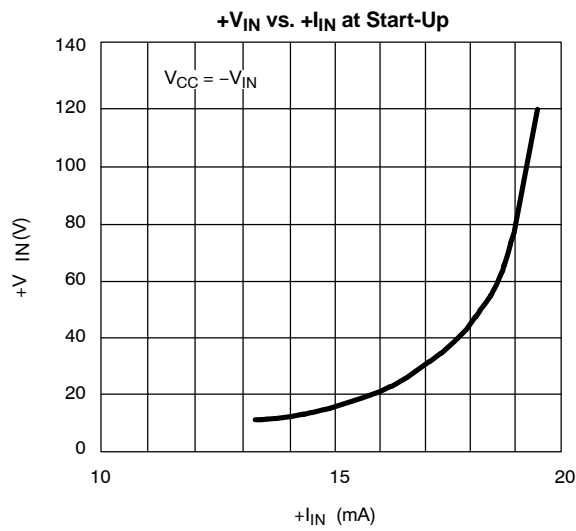

FIGURE 4.

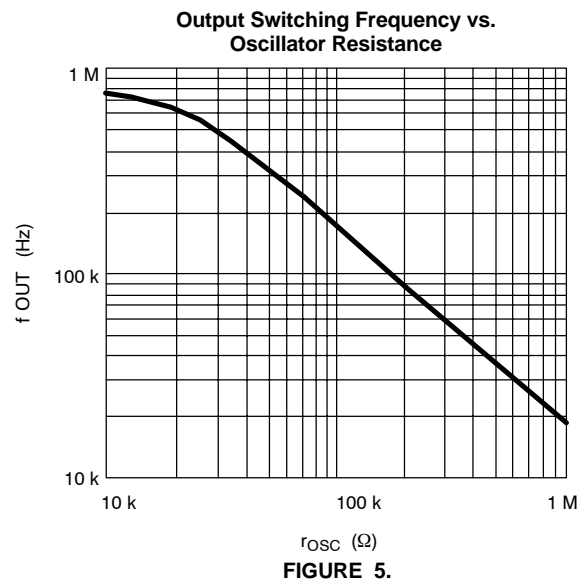
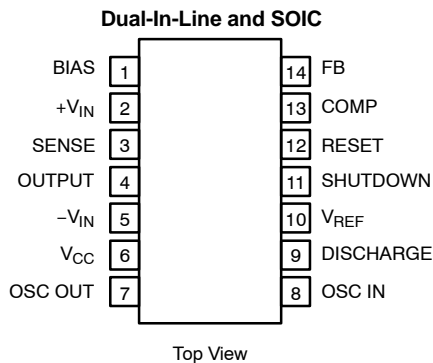

FIGURE 5.

PIN CONFIGURATIONS AND ORDERING INFORMATION



ORDERING INFORMATION

| Part Number | Temperature Range | Package |
|----------------|-------------------|---------|
| Si9110DY | -40 to 85°C | SOIC-14 |
| Si9110DY-T1 | | |
| Si9110DY-T1—E3 | | |
| Si9111DY | | |
| Si9111DY-T1 | | |
| Si9111DY-T1—E3 | | |
| Si9110DJ | | PDIP-14 |
| Si9110DJ-T1 | | |
| Si9111DJ | | |
| Si9111DJ-T1 | | |

DETAILED DESCRIPTION

Pre-Regulator/Start-Up Section

Due to the low quiescent current requirement of the Si9110/9111 control circuitry, bias power can be supplied from the unregulated input power source, from an external regulated low-voltage supply, or from an auxiliary “bootstrap” winding on the output inductor or transformer.

When power is first applied during start-up, $+V_{IN}$ (pin 2) will draw a constant current. The magnitude of this current is determined by a high-voltage depletion MOSFET device which is connected between $+V_{IN}$ and V_{CC} (pin 6). This start-up circuitry provides initial power to the IC by charging an external bypass capacitance connected to the V_{CC} pin. The constant current is disabled when V_{CC} exceeds 8.6 V. If V_{CC} is not forced to exceed the 8.6-V threshold, then V_{CC} will be regulated to a nominal value of 8.6 V by the pre-regulator circuit.

As the supply voltage rises toward the normal operating conditions, an internal undervoltage (UV) lockout circuit keeps the output driver disabled until V_{CC} exceeds the undervoltage lockout threshold (typically 8.1 V). This guarantees that the control logic will be functioning properly and that sufficient gate drive voltage is available before the MOSFET turns on. The design of the IC is such that the undervoltage lockout threshold will be at least 300 mV less than the pre-regulator turn-off voltage. Power dissipation can be minimized by providing an external power source to V_{CC} such that the constant current source is always disabled.

Note: During start-up or when V_{CC} drops below 8.6 V the start-up circuit is capable of sourcing up to 20 mA. This may

lead to a high level of power dissipation in the IC (for a 48-V input, approximately 1 W). Excessive start-up time caused by external loading of the V_{CC} supply can result in device damage. Figure 6 gives the typical pre-regulator current at BiC/DMOS as a function of input voltage.

BIAS

To properly set the bias for the Si9110/9111, a 390-k Ω resistor should be tied from BIAS (pin 1) to $-V_{IN}$ (pin 5). This determines the magnitude of bias current in all of the analog sections and the pull-up current for the $\overline{\text{SHUTDOWN}}$ and RESET pins. The current flowing in the bias resistor is nominally 15 μA .

Reference Section

The reference section of the Si9110 consists of a temperature compensated buried zener and trimmable divider network. The output of the reference section is connected internally to the non-inverting input of the error amplifier. Nominal reference output voltage is 4 V. The trimming procedure that is used on the Si9110 brings the output of the error amplifier (which is configured for unity gain during trimming) to within $\pm 1\%$ of 4 V. This compensates for input offset voltage in the error amplifier.

The output impedance of the reference section has been purposely made high so that a low impedance external voltage source can be used to override the internal voltage source, if desired, without otherwise altering the performance of the device.

DETAILED DESCRIPTION (CONT'D)

Applications which use a separate external reference, such as non-isolated converter topologies and circuits employing optical coupling in the feedback loop, do not require a trimmed voltage reference with 1% accuracy. The Si9111 accommodates the requirements of these applications at a lower cost, by leaving the reference voltage untrimmed. The 10% accurate reference thus provided is sufficient to establish a dc bias point for the error amplifier.

Error Amplifier

Closed-loop regulation is provided by the error amplifier, which is intended for use with “around-the-amplifier” compensation. A MOS differential input stage provides for low input current. The noninverting input to the error amplifier (V_{REF}) is internally connected to the output of the reference supply and should be bypassed with a small capacitor to ground.

Oscillator Section

The oscillator consists of a ring of CMOS inverters, capacitors, and a capacitor discharge switch. Frequency is set by an external resistor between the OSC IN and OSC OUT pins. (See Figure 5 for details of resistor value vs. frequency.) The DISCHARGE pin should be tied to $-V_{IN}$ for normal internal oscillator operation. A frequency divider in the logic section limits switch duty cycle to $\leq 50\%$ by locking the switching frequency to one half of the oscillator frequency.



Remote synchronization is accomplished by capacitive coupling of a positive SYNC pulse into the OSC IN (pin 8) terminal. For a 5-V pulse amplitude and 0.5- μ s pulse width, typical values would be 100 pF in series with 3 k Ω to pin 8.

SHUTDOWN and RESET

SHUTDOWN (pin 11) and RESET (pin 12) are intended for overriding the output MOSFET switch via external control

logic. The two inputs are fed through a latch preceding the output switch. Depending on the logic state of RESET, SHUTDOWN can be either a latched or unlatched input. The output is off whenever SHUTDOWN is low. By simultaneously having SHUTDOWN and RESET low, the latch is set and SHUTDOWN has no effect until RESET goes high. The truth table for these inputs is given in Table 1.

Table 1: Truth Table for the SHUTDOWN and RESET Pins

| SHUTDOWN | RESET | Output |
|-----------------------------------------------------------------------------------|-------------------------------------------------------------------------------------|------------------------------|
| H | H | Normal Operation |
| H |  | Normal Operation (No Change) |
| L | H | Off (Not Latched) |
| L | L | Off (Latched) |
|  | L | Off (Latched, No Change) |

Both pins have internal current source pull-ups and should be left disconnected when not in use. An added feature of the current sources is the ability to connect a capacitor and an open-collector driver to the SHUTDOWN or RESET pins to provide variable shutdown time.

Output Driver

The push-pull driver output has a typical on-resistance of 20 Ω . Maximum switching times are specified at 75 ns for a 500-pF load. This is sufficient to directly drive MOSFETs such as the 2N7004, 2N7005, IRFD120 and IRFD220. Larger devices can be driven, but switching times will be longer, resulting in higher switching losses. In order to drive large MOSPOWER devices, it is necessary to use an external driver IC, such as the Vishay Siliconix D469A. The D469A can switch very large devices such as the SMM20N50 (500 V, 0.3 Ω) in approximately 100 ns.

