

Features

- 300MHz -3dB bandwidth
- 4mA supply current
- Single and dual supply operation, from 5V to 10V supply span
- Available in 5-pin SOT23 package
- Dual (EL5293C) and triple (EL5393C) available
- High speed, 1GHz product available (EL5193C)
- High speed, 6mA, 600MHz product available (EL5192C, EL5292C, and EL5392C)

Applications

- Battery Powered Equipment
- Hand Held, Portable Devices
- Video Amplifiers
- Cable Drivers
- RGB Amplifiers
- Test Equipment
- Instrumentation
- Current to Voltage Converters

Ordering Information

Part No	Package	Tape & Reel	Outline #
EL5193CW-T7	5-Pin SOT23	7"	MDP0038
EL5193CW-T13	5-Pin SOT23	13"	MDP0038
EL5193CS	8-Pin SO	-	MDP0027
EL5193CS-T7	8-Pin SO	7"	MDP0027
EL5193CS-T13	8-Pin SO	13"	MDP0027

General Description

The EL5193C is a current feedback amplifier with a bandwidth of 300MHz. This makes these amplifiers ideal for today's high speed video and monitor applications.

With a supply current of just 4mA and the ability to run from a single supply voltage from 5V to 10V, these amplifiers are also ideal for hand held, portable or battery-powered equipment.

For applications where board space is critical, the EL5193C is offered in the 5-pin SOT23 package, as well as an industry standard 8-pin SO. The EL5193C operates over the industrial temperature range of -40°C to +85°C.

Pin Configurations

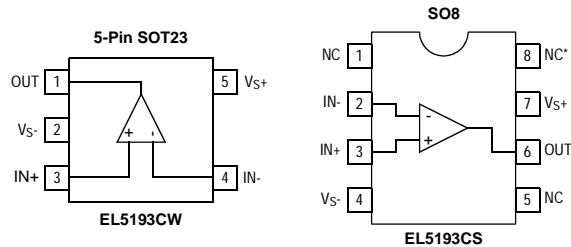

* This pin must be left disconnected

Note: All information contained in this data sheet has been carefully checked and is believed to be accurate as of the date of publication; however, this data sheet cannot be a "controlled document". Current revisions, if any, to these specifications are maintained at the factory and are available upon your request. We recommend checking the revision level before finalization of your design documentation.

EL5193C

Single 300MHz Current Feedback Amplifier

Absolute Maximum Ratings (T_A = 25°C)

Values beyond absolute maximum ratings can cause the device to be prematurely damaged. Absolute maximum ratings are stress ratings only and functional device operation is not implied.

Supply Voltage between V_{S+} and V_{S-} 11V
Maximum Continuous Output Current 50mA

Operating Junction Temperature 125°C
Power Dissipation See Curves
Pin Voltages V_{S-} - 0.5V to V_{S+} +0.5V
Storage Temperature -65°C to +150°C
Operating Temperature -40°C to +85°C

Important Note:

All parameters having Min/Max specifications are guaranteed. Typ values are for information purposes only. Unless otherwise noted, all tests are at the specified temperature and are pulsed tests, therefore: T_J = T_C = T_A.

Electrical Characteristics

V_{S+} = +5V, V_{S-} = -5V, R_F = 750Ω for A_V = 1, R_F = 400Ω for A_V = 2, R_L = 150Ω, T_A = 25°C unless otherwise specified.

Parameter	Description	Conditions	Min	Typ	Max	Unit
AC Performance						
BW	-3dB Bandwidth	A _V = +1		300		MHz
		A _V = +2		200		MHz
BW1	0.1dB Bandwidth			20		MHz
SR	Slew Rate	V _O = -2.5V to +2.5V, A _V = +2	2400	2600		V/μs
t _s	0.1% Settling Time	V _{OUT} = -2.5V to +2.5V, A _V = -1		12		ns
e _n	Input Voltage Noise			4.4		nV/√Hz
i _{n-}	IN- input current noise			17		pA/√Hz
i _{n+}	IN+ input current noise			50		pA/√Hz
dG	Differential Gain Error ^[1]	A _V = +2		0.03		%
dP	Differential Phase Error ^[1]	A _V = +2		0.04		°
DC Performance						
V _{OS}	Offset Voltage		-10	1	10	mV
T _C V _{OS}	Input Offset Voltage Temperature Coefficient	Measured from T _{MIN} to T _{MAX}		5		μV/°C
R _{OL}	Transimpedance		300	500		kΩ
Input Characteristics						
CMIR	Common Mode Input Range		±3	±3.3		V
CMRR	Common Mode Rejection Ratio		42	50		dB
-ICMR	- Input Current Common Mode Rejection		-6		6	μA/V
+I _{IN}	+ Input Current		-60	1	60	μA
-I _{IN}	- Input Current		-30	1	30	μA
R _{IN}	Input Resistance			45		kΩ
C _{IN}	Input Capacitance			0.5		pF
Output Characteristics						
V _O	Output Voltage Swing	R _L = 150Ω to GND	±3.4	±3.7		V
		R _L = 1kΩ to GND	±3.8	±4.0		V
I _{OUT}	Output Current	R _L = 10Ω to GND	95	120		mA
Supply						
I _{SON}	Supply Current	No Load, V _{IN} = 0V	3	4	5	mA
PSRR	Power Supply Rejection Ratio	DC, V _S = ±4.75V to ±5.25V	55	75		dB
-IPSR	- Input Current Power Supply Rejection	DC, V _S = ±4.75V to ±5.25V	-2		2	μA/V

1. Standard NTSC test, AC signal amplitude = 286mV_{p-p}, f = 3.58MHz

Typical Performance Curves

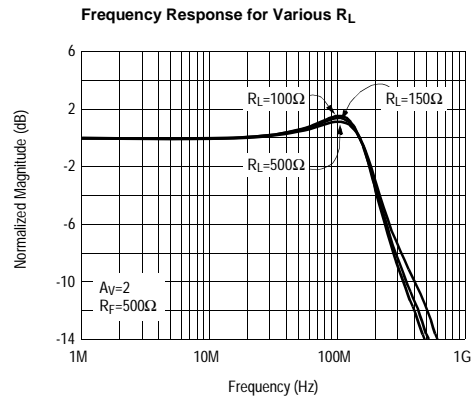
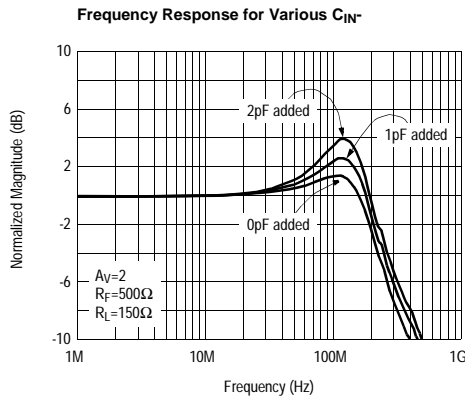
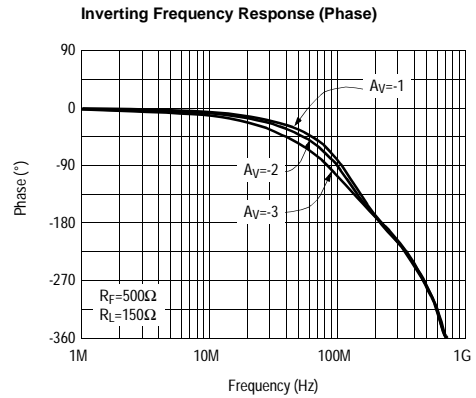
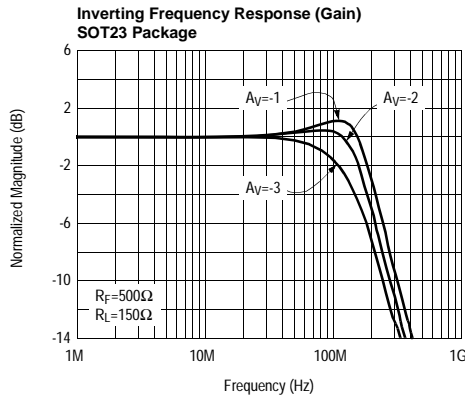
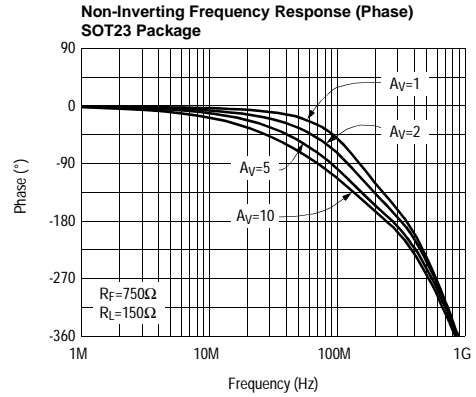
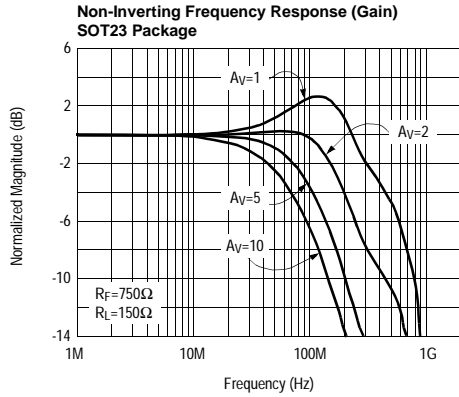

EL5193C

Single 300MHz Current Feedback Amplifier

Typical Performance Curves

Frequency Response for Various C_L

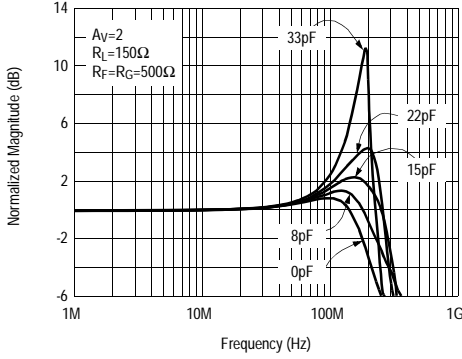

Frequency Response for Various R_F

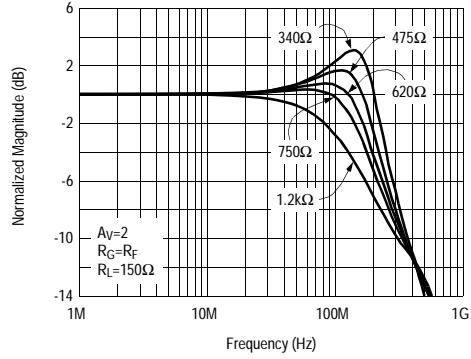

Group Delay vs Frequency

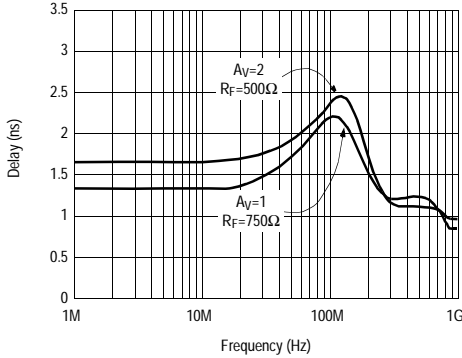

Frequency Response for Various Common-mode Input Voltages

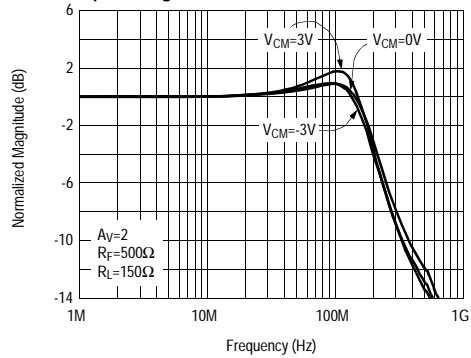

Transimpedance (ROL) vs Frequency

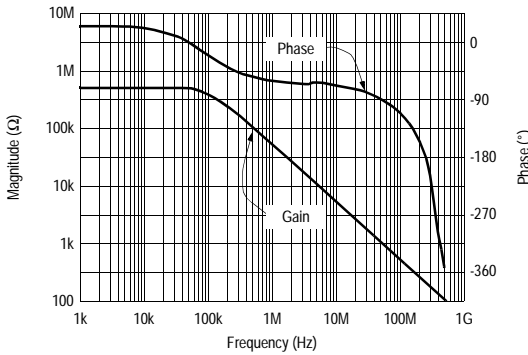

PSRR and CMRR vs Frequency

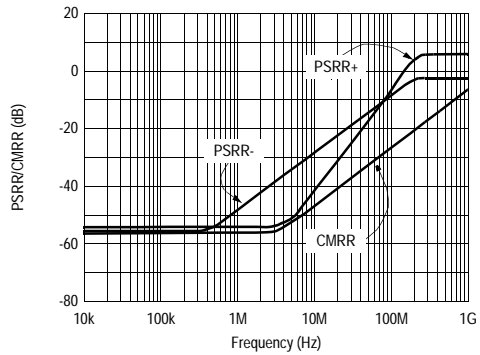

Typical Performance Curves

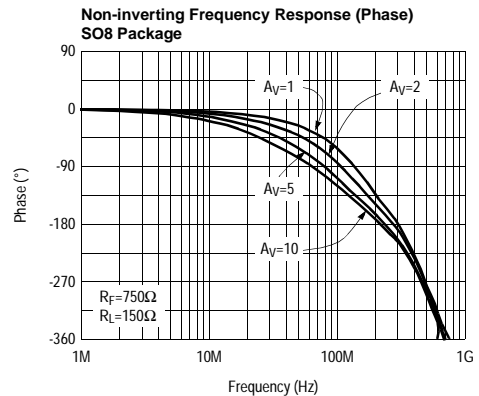
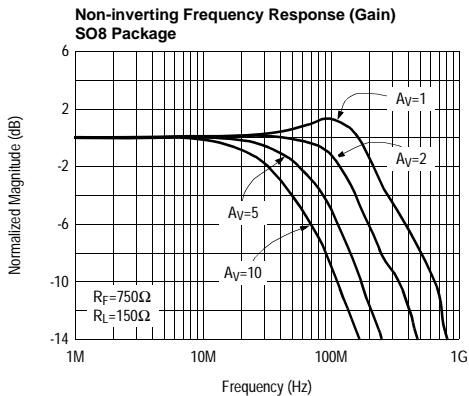
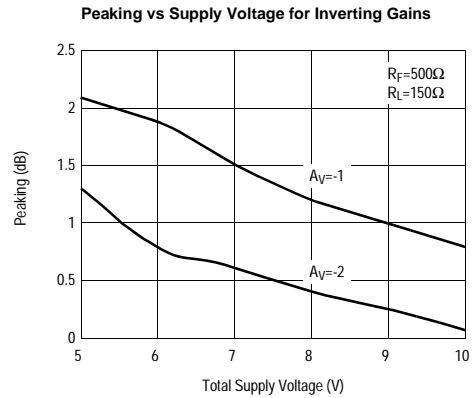
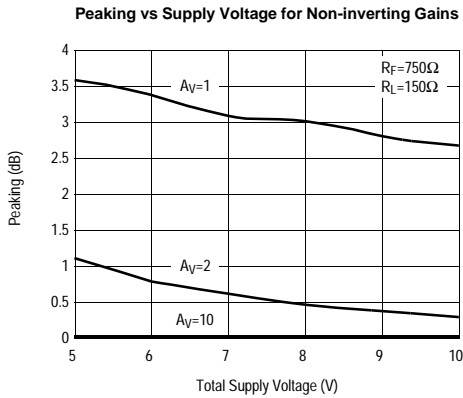
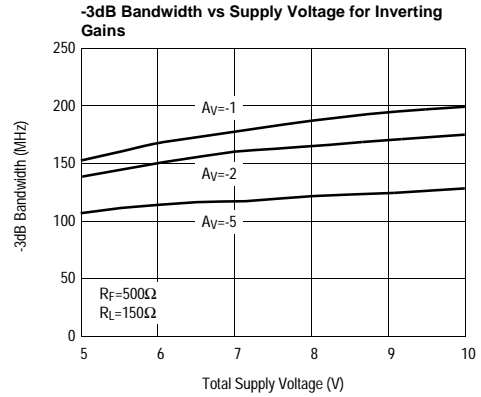
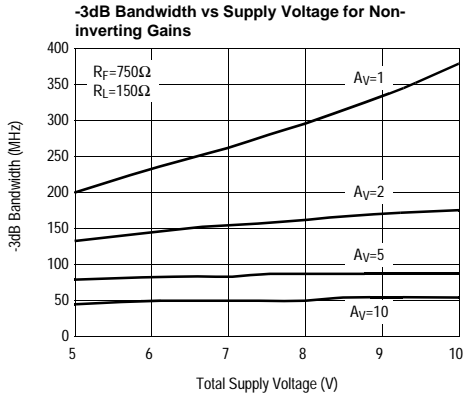

EL5193C

Single 300MHz Current Feedback Amplifier

Typical Performance Curves

Inverting Frequency Response (Gain)
SO8 Package

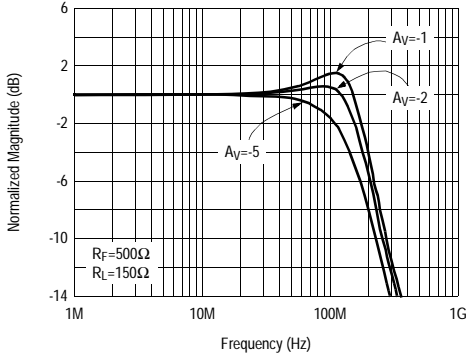

Inverting Frequency Response (Phase)
SO8 Package

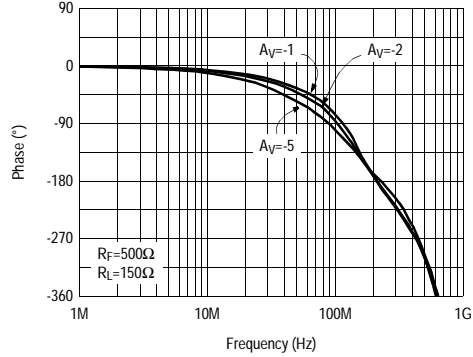

-3dB Bandwidth vs Temperature for Non-inverting Gains

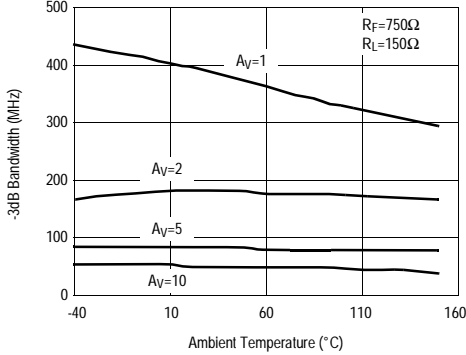

-3dB Bandwidth vs Temperature for Inverting Gains

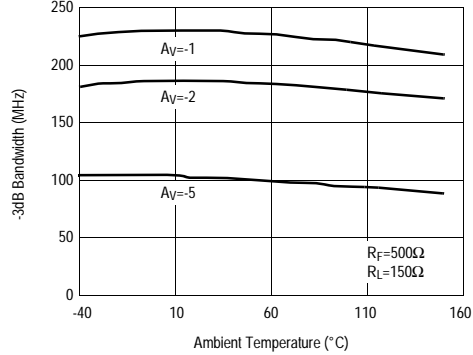

Peaking vs Temperature

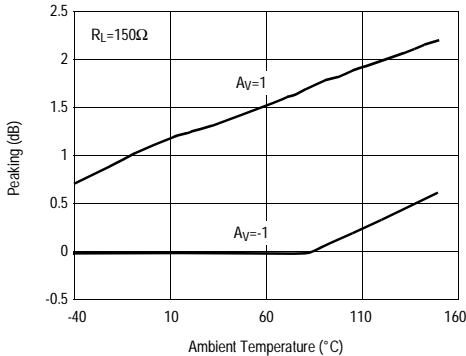

Voltage and Current Noise vs Frequency

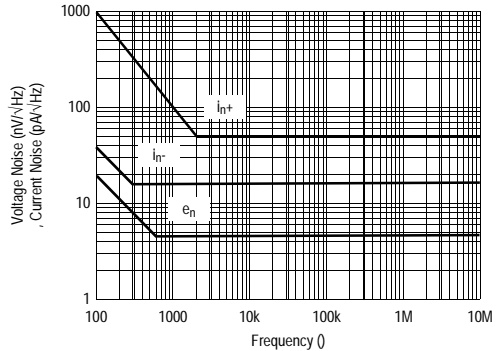

Typical Performance Curves

Closed Loop Output Impedance vs Frequency

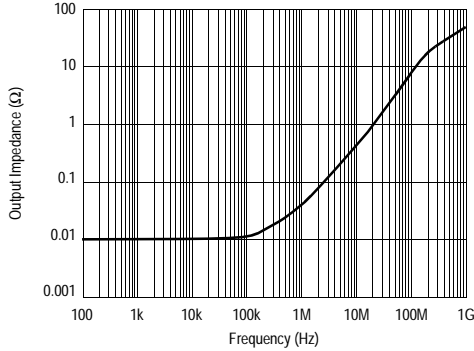

Supply Current vs Supply Voltage

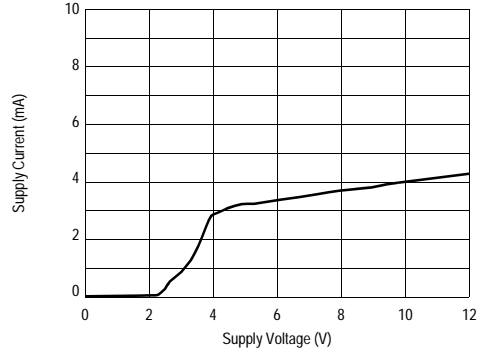

2nd and 3rd Harmonic Distortion vs Frequency

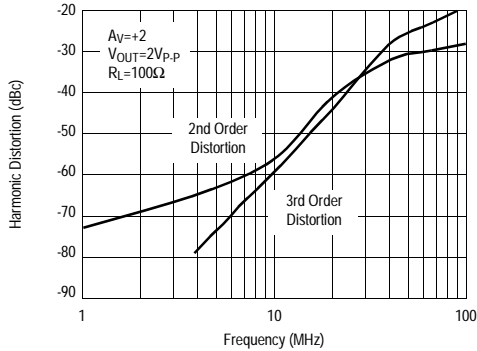

Two-tone 3rd Order Input Referred Intermodulation Intercept (IIP3)

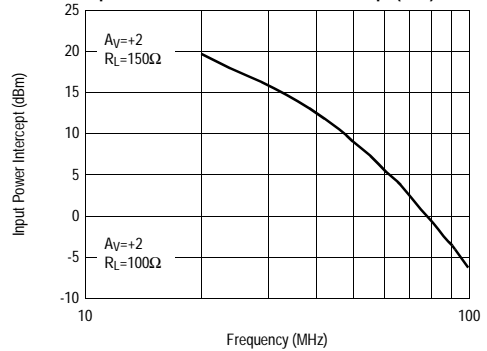

Differential Gain/Phase vs DC Input Voltage at 3.58MHz

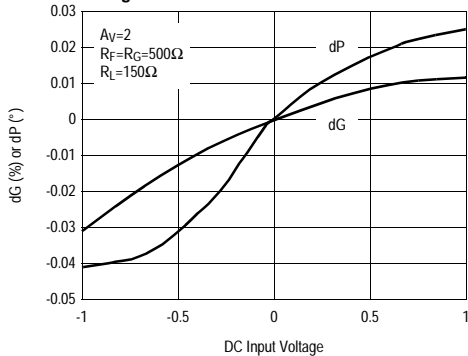

Differential Gain/Phase vs DC Input Voltage at 3.58MHz

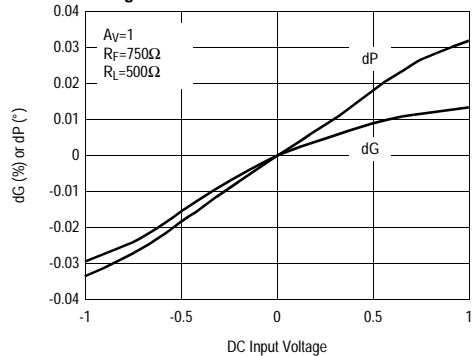

EL5193C

Single 300MHz Current Feedback Amplifier

Typical Performance Curves

Output Voltage Swing vs Frequency
THD<1%

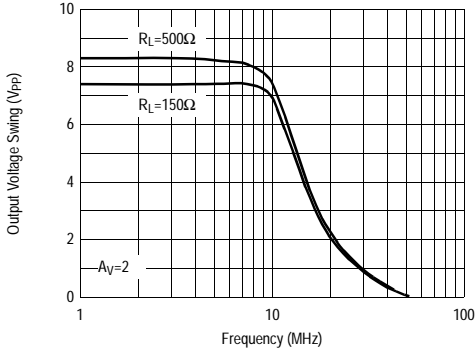

Output Voltage Swing vs Frequency
THD<0.1%

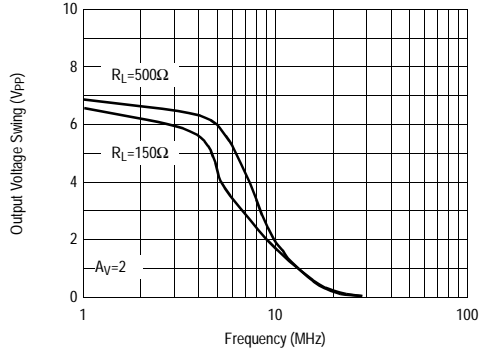

Small Signal Step Response

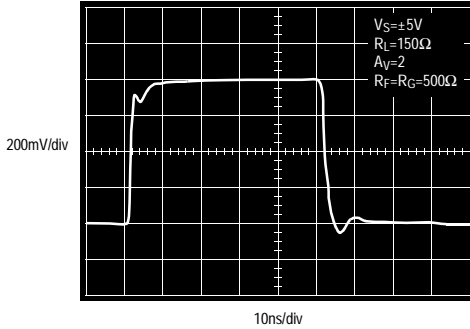

Large Signal Step Response

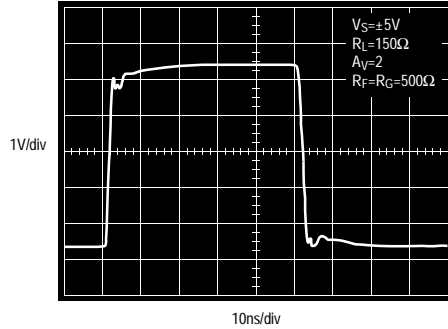

Settling Time vs Settling Accuracy

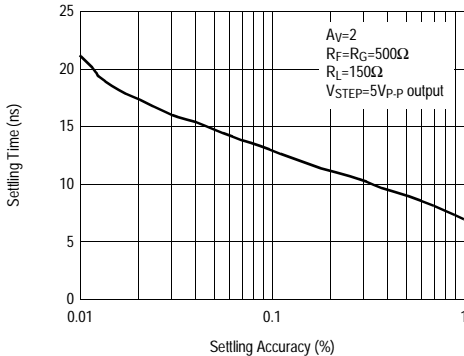

Transimpedance (RoI) vs Temperature

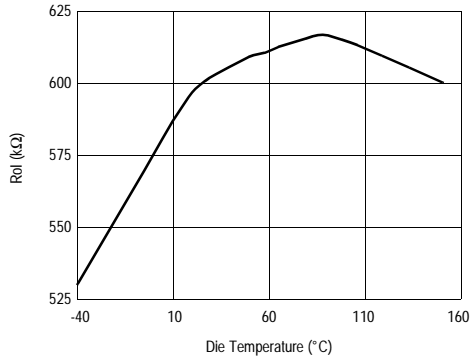

Typical Performance Curves

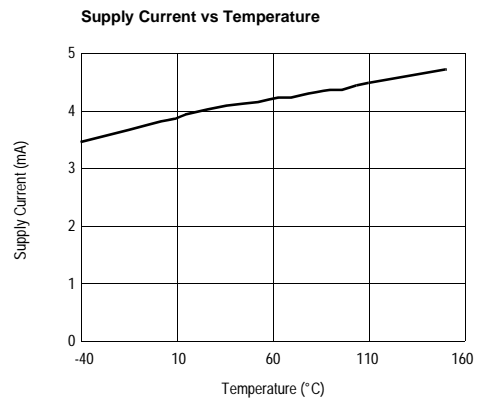
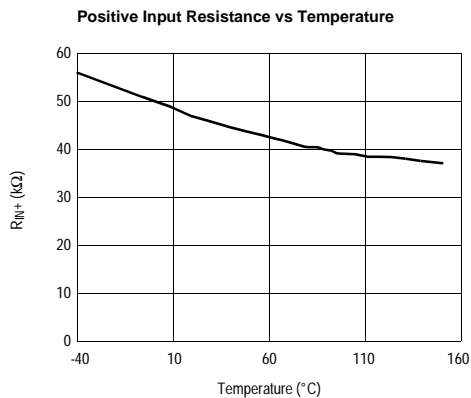
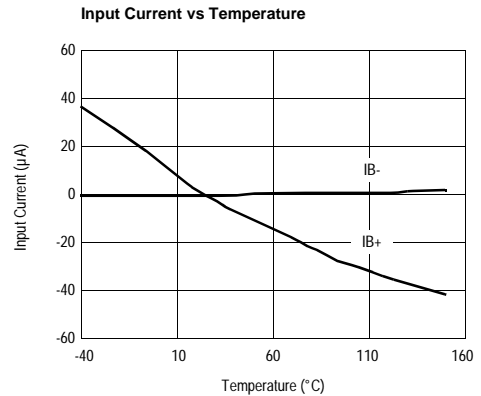
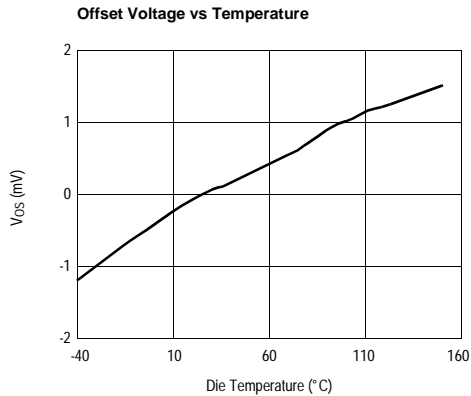
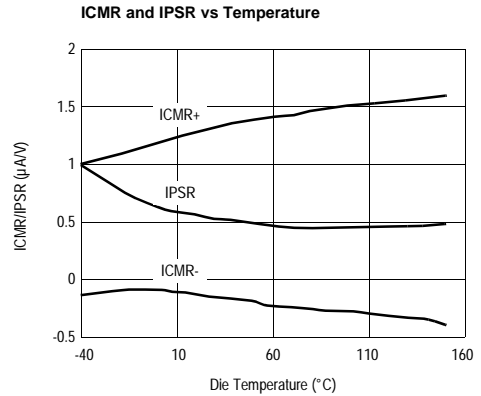
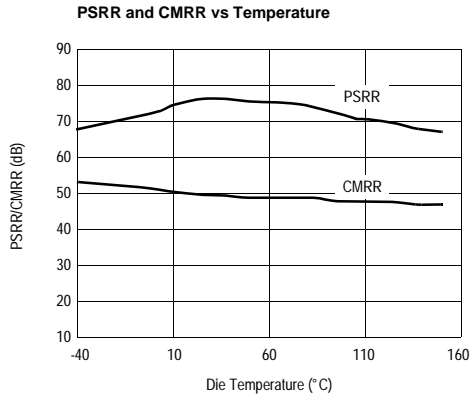

EL5193C

Single 300MHz Current Feedback Amplifier

Typical Performance Curves

Positive Output Swing vs Temperature for Various Loads

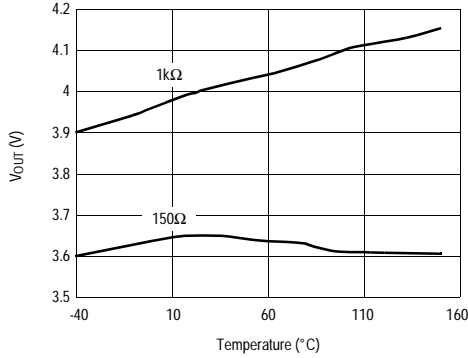

Negative Output Swing vs Temperature for Various Loads

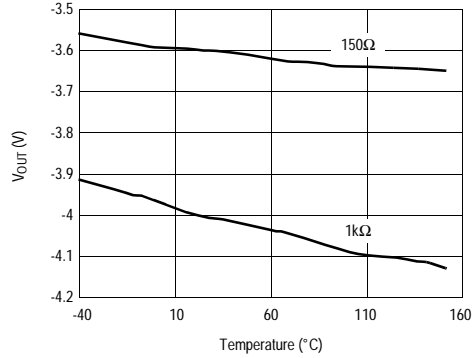

Output Current vs Temperature

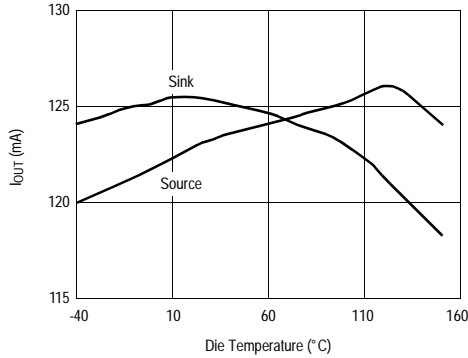

Slew Rate vs Temperature

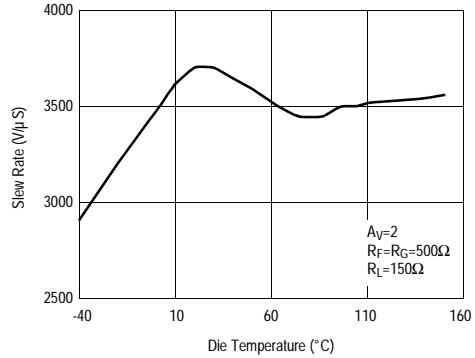

Maximum Power Dissipation vs Ambient Temperature

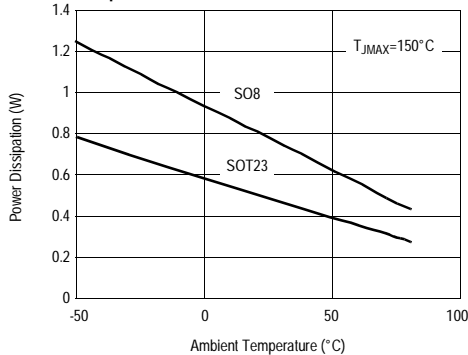

Package Power Dissipation vs Ambient Temp. JEDEC JESD51-3 Low Effective Thermal Conductivity Test Board

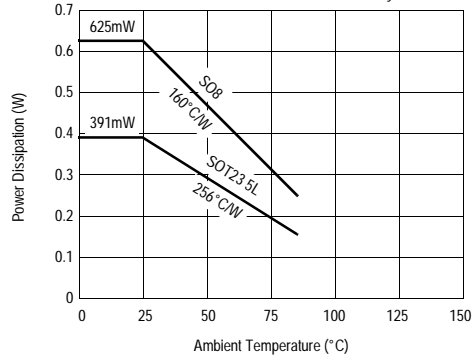

Pin Descriptions

EL5193C 8-Pin SO	EL5193C 5-Pin SOT23	Pin Name	Function	Equivalent Circuit
1,5		NC	Not connected	
2	4	IN-	Inverting input	<p style="text-align: center;">Circuit1</p>
3	3	IN+	Non-inverting input	(See circuit 1)
4	2	VS-	Negative supply	
6	1	OUT	Output	<p style="text-align: center;">Circuit 2</p>
7	5	VS+	Positive supply	
8		NC	Not connected (leave this pin disconnected)	

EL5193C

Single 300MHz Current Feedback Amplifier

Applications Information

Product Description

The EL5193C is a current-feedback operational amplifier that offers a wide -3dB bandwidth of 300MHz and a low supply current of 4mA per amplifier. The EL5193C works with supply voltages ranging from a single 5V to 10V and they are also capable of swinging to within 1V of either supply on the output. Because of their current-feedback topology, the EL5193C does not have the normal gain-bandwidth product associated with voltage-feedback operational amplifiers. Instead, its -3dB bandwidth to remain relatively constant as closed-loop gain is increased. This combination of high bandwidth and low power, together with aggressive pricing make the EL5193C the ideal choice for many low-power/high-bandwidth applications such as portable, handheld, or battery-powered equipment.

For varying bandwidth needs, consider the EL5191C with 1GHz on a 9mA supply current or the EL5192C with 600MHz on a 6mA supply current. Versions include single, dual, and triple amp packages with 5-pin SOT23, 16-pin QSOP, and 8-pin or 16-pin SO outlines.

Power Supply Bypassing and Printed Circuit Board Layout

As with any high frequency device, good printed circuit board layout is necessary for optimum performance. Low impedance ground plane construction is essential. Surface mount components are recommended, but if leaded components are used, lead lengths should be as short as possible. The power supply pins must be well bypassed to reduce the risk of oscillation. The combination of a 4.7 μ F tantalum capacitor in parallel with a 0.01 μ F capacitor has been shown to work well when placed at each supply pin.

For good AC performance, parasitic capacitance should be kept to a minimum, especially at the inverting input. (See the Capacitance at the Inverting Input section) Even when ground plane construction is used, it should be removed from the area near the inverting input to minimize any stray capacitance at that node. Carbon or Metal-Film resistors are acceptable with the Metal-Film resistors giving slightly less peaking and bandwidth because of additional series inductance. Use of sockets,

particularly for the SO package, should be avoided if possible. Sockets add parasitic inductance and capacitance which will result in additional peaking and overshoot.

Capacitance at the Inverting Input

Any manufacturer's high-speed voltage- or current-feedback amplifier can be affected by stray capacitance at the inverting input. For inverting gains, this parasitic capacitance has little effect because the inverting input is a virtual ground, but for non-inverting gains, this capacitance (in conjunction with the feedback and gain resistors) creates a pole in the feedback path of the amplifier. This pole, if low enough in frequency, has the same destabilizing effect as a zero in the forward open-loop response. The use of large-value feedback and gain resistors exacerbates the problem by further lowering the pole frequency (increasing the possibility of oscillation.)

The EL5193C has been optimized with a 475 Ω feedback resistor. With the high bandwidth of these amplifiers, these resistor values might cause stability problems when combined with parasitic capacitance, thus ground plane is not recommended around the inverting input pin of the amplifier.

Feedback Resistor Values

The EL5193C has been designed and specified at a gain of +2 with R_F approximately 500 Ω . This value of feedback resistor gives 200MHz of -3dB bandwidth at $A_V=2$ with 2dB of peaking. With $A_V=-2$, an R_F of approximately 500 Ω gives 175MHz of bandwidth with 0.2dB of peaking. Since the EL5193C is a current-feedback amplifier, it is also possible to change the value of R_F to get more bandwidth. As seen in the curve of Frequency Response for Various R_F and R_G , bandwidth and peaking can be easily modified by varying the value of the feedback resistor.

Because the EL5193C is a current-feedback amplifier, its gain-bandwidth product is not a constant for different closed-loop gains. This feature actually allows the EL5193C to maintain about the same -3dB bandwidth. As gain is increased, bandwidth decreases slightly while

stability increases. Since the loop stability is improving with higher closed-loop gains, it becomes possible to reduce the value of R_F below the specified 475Ω and still retain stability, resulting in only a slight loss of bandwidth with increased closed-loop gain.

Supply Voltage Range and Single-Supply Operation

The EL5193C has been designed to operate with supply voltages having a span of greater than 5V and less than 10V. In practical terms, this means that the EL5193C will operate on dual supplies ranging from $\pm 2.5V$ to $\pm 5V$. With single-supply, the EL5193C will operate from 5V to 10V.

As supply voltages continue to decrease, it becomes necessary to provide input and output voltage ranges that can get as close as possible to the supply voltages. The EL5193C has an input range which extends to within 2V of either supply. So, for example, on +5V supplies, the EL5193C has an input range which spans $\pm 3V$. The output range of the EL5193C is also quite large, extending to within 1V of the supply rail. On a $\pm 5V$ supply, the output is therefore capable of swinging from -4V to +4V. Single-supply output range is larger because of the increased negative swing due to the external pull-down resistor to ground.

Video Performance

For good video performance, an amplifier is required to maintain the same output impedance and the same frequency response as DC levels are changed at the output. This is especially difficult when driving a standard video load of 150Ω , because of the change in output current with DC level. Previously, good differential gain could only be achieved by running high idle currents through the output transistors (to reduce variations in output impedance.) These currents were typically comparable to the entire 4mA supply current of each EL5193C amplifier. Special circuitry has been incorporated in the EL5193C to reduce the variation of output impedance with current output. This results in dG and dP specifications of 0.03% and 0.04°, while driving 150Ω at a gain of 2.

Video performance has also been measured with a 500Ω load at a gain of +1. Under these conditions, the EL5193C has dG and dP specifications of 0.03% and 0.04°.

Output Drive Capability

In spite of its low 4mA of supply current, the EL5193C is capable of providing a minimum of $\pm 95mA$ of output current. With a minimum of $\pm 95mA$ of output drive, the EL5193C is capable of driving 50Ω loads to both rails, making it an excellent choice for driving isolation transformers in telecommunications applications.

Driving Cables and Capacitive Loads

When used as a cable driver, double termination is always recommended for reflection-free performance. For those applications, the back-termination series resistor will decouple the EL5193C from the cable and allow extensive capacitive drive. However, other applications may have high capacitive loads without a back-termination resistor. In these applications, a small series resistor (usually between 5Ω and 50Ω) can be placed in series with the output to eliminate most peaking. The gain resistor (R_G) can then be chosen to make up for any gain loss which may be created by this additional resistor at the output. In many cases it is also possible to simply increase the value of the feedback resistor (R_F) to reduce the peaking.

Current Limiting

The EL5193C has no internal current-limiting circuitry. If the output is shorted, it is possible to exceed the Absolute Maximum Rating for output current or power dissipation, potentially resulting in the destruction of the device.

Power Dissipation

With the high output drive capability of the EL5193C, it is possible to exceed the $125^\circ C$ Absolute Maximum junction temperature under certain very high load current conditions. Generally speaking when R_L falls below about 25Ω , it is important to calculate the maximum junction temperature (T_{JMAX}) for the application to determine if power supply voltages, load conditions, or package type need to be modified for the EL5193C to

EL5193C

Single 300MHz Current Feedback Amplifier

remain in the safe operating area. These parameters are calculated as follows:

$$T_{JMAX} = T_{MAX} + (\theta_{JA} \times n \times PD_{MAX})$$

where:

T_{MAX} = Maximum Ambient Temperature

θ_{JA} = Thermal Resistance of the Package

n = Number of Amplifiers in the Package

PD_{MAX} = Maximum Power Dissipation of Each Amplifier in the Package

PD_{MAX} for each amplifier can be calculated as follows:

$$PD_{MAX} = (2 \times V_S \times I_{SMAX}) + \left[(V_S - V_{OUTMAX}) \times \frac{V_{OUTMAX}}{R_L} \right]$$

where:

V_S = Supply Voltage

I_{SMAX} = Maximum Supply Current of 1A

V_{OUTMAX} = Maximum Output Voltage (Required)

R_L = Load Resistance

Typical Application Circuits

Inverting 200mA Output Current Distribution Amplifier

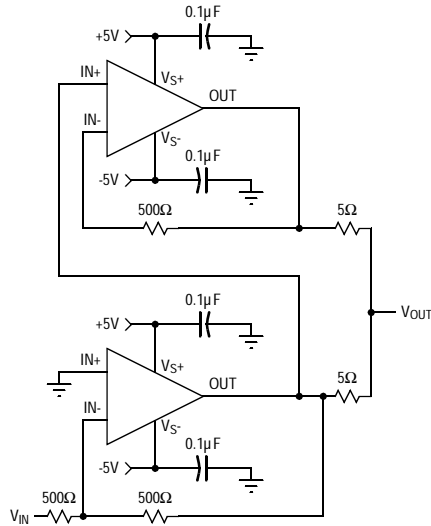

Fast-Settling Precision Amplifier

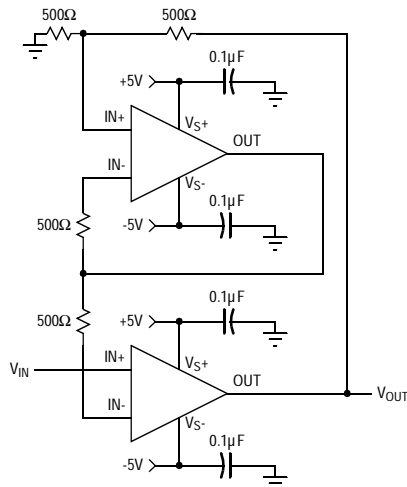

EL5193C

Single 300MHz Current Feedback Amplifier

Typical Application Circuits

Differential Line Driver/Receiver

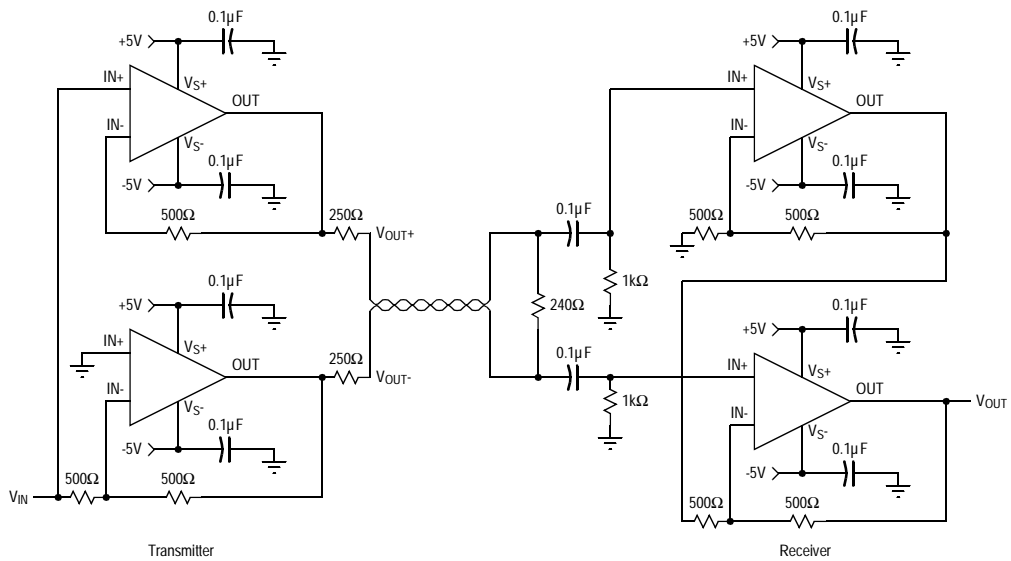

EL5193C

Single 300MHz Current Feedback Amplifier

General Disclaimer

Specifications contained in this data sheet are in effect as of the publication date shown. Elantec, Inc. reserves the right to make changes in the circuitry or specifications contained herein at any time without notice. Elantec, Inc. assumes no responsibility for the use of any circuits described herein and makes no representations that they are free from patent infringement.

élan^{te}c

HIGH PERFORMANCE ANALOG INTEGRATED CIRCUITS

Elantec Semiconductor, Inc.

675 Trade Zone Blvd.

Milpitas, CA 95035

Telephone: (408) 945-1323

(888) ELANTEC

Fax: (408) 945-9305

European Office: +44-118-977-6020

Japan Technical Center: +81-45-682-5820

WARNING - Life Support Policy

Elantec, Inc. products are not authorized for and should not be used within Life Support Systems without the specific written consent of Elantec, Inc. Life Support systems are equipment intended to support or sustain life and whose failure to perform when properly used in accordance with instructions provided can be reasonably expected to result in significant personal injury or death. Users contemplating application of Elantec, Inc. Products in Life Support Systems are requested to contact Elantec, Inc. factory headquarters to establish suitable terms & conditions for these applications. Elantec, Inc.'s warranty is limited to replacement of defective components and does not cover injury to persons or property or other consequential damages.