

FEATURES

- Ultra-Low Noise Output
- High Output Voltage Accuracy
- Guaranteed 150mA Output
- Low Quiescent Current
- Low Dropout Voltage
- Extremely Tight Load and Line Regulation
- Very Low Temperature Coefficient
- Current and Thermal Limiting
- Reverse-Battery Protection
- "Zero" OFF-Mode Current
- Logic-Controlled Electronic Enable

APPLICATIONS

- Cellular Telephones
- Laptop, Notebook, and Palmtop Computers
- Battery Powered Equipment
- PCMCIA V_{CC} and V_{PP} Regulation/Switching
- Consumer/Personal Electronics
- SMPS Post-Regulator/ DC toDC Modules
- High Efficiency Linear Power Supplies

GENERAL DESCRIPTION

The Calogic CLM5205 is a low noise, low dropout voltage regulator featuring ultra low ground current (800uA at 100mA output) and tighter than 1% initial accuracy with a logic compatible ON/OFF switching input. Designed for hand-held battery powered devices, the CLM505 is switched by a CMOS or TTL compatible logic signal. When disabled, power consumption drops nearly to zero. Prolonging battery life, the ground current of the CLM5205 increases only slightly in dropout. Major features of the CLM5205 include a reference bypass pin for excellent low-noise performance, protection against reversed battery, current limiting, and overtemperature shutdown.

The CLM5202 is available in several fixed voltages and an adjustable output voltage version in a small SOT-23-5 package. The pinout is smaller to the LP2980 with significantly better performance.

ORDERING INFORMATION

Part	Voltage	Package	Temperature Range
CLM5205M	Adjustable	SOT-23-5	-40°C to +125°C
CLM5205M-5.0	5.0V	SOT-23-5	-40°C to +125°C
CLM5205M-4.7	4.7V	SOT-23-5	-40°C to +125°C
CLM5205M-4.0	4.0V	SOT-23-5	-40°C to +125°C
CLM5205M-3.6	3.6V	SOT-23-5	-40°C to +125°C
CLM5205M-3.3	3.3V	SOT-23-5	-40°C to +125°C
CLM5205M-3.0	3.0V	SOT-23-5	-40°C to +125°C
CLM5205M-2.85	2.85V	SOT-23-5	-40°C to +125°C

PIN CONFIGURATION

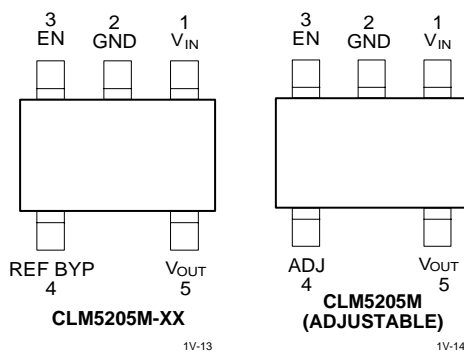

TYPICAL APPLICATION

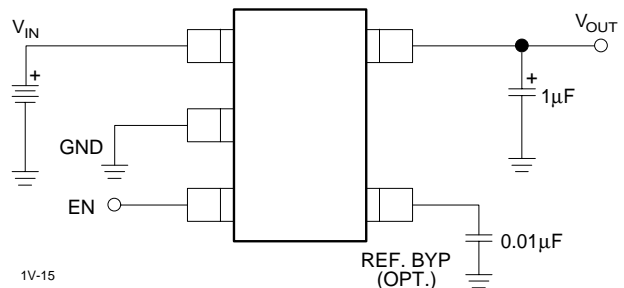

ABSOLUTE MAXIMUM RATINGS

Absolute Maximum Ratings indicate limits beyond which damage to the device may occur. Electrical specifications do not apply when operating the device beyond its specified Operating Ratings.

Power Dissipation Internally Limited
 Lead Temperature (Soldering 5 seconds) 260°C
 Operating Junction Temperature Range -40°C to +125°C
 Input Supply Voltage -20V to +20V
 ENABLE Input Voltage -20V to +20V

RECOMMENDED OPERATING CONDITIONS

Input Voltage 2.5V to 16V
 Operating Junction Temperature Range -40°C to +125°C
 ENABLE Input Voltage 0V to V_{IN}
 SOT-23-5 θ_{JA} See Note 1

DC ELECTRICAL CHARACTERISTICS

Limits in standard typeface are for $T_J = 25^\circ\text{C}$ and limits in **boldface** apply over the junction temperature range of -40°C to $+125^\circ\text{C}$. Unless otherwise specified, $V_{IN} = V_{OUT} + 1\text{V}$, $I_L = 100\mu\text{A}$, $C_L = 3.3\mu\text{F}$, and $V_{ENABLE} \geq 2.0\text{V}$.

SYMBOL	PARAMETER	MIN	TYP	MAX	UNITS	CONDITIONS
V_O	Output Voltage Accuracy	-1 -2		1 2	%	Variation from specified V_{OUT}
$\frac{\Delta V_O}{\Delta T}$	Output Voltage Temperature Coefficient		40		ppm/°C	(Note 2)
$\frac{\Delta V_O}{V_O}$	Line Regulation		0.004		%	$V_{IN} = V_{OUT} + 1\text{V}$ to 16V
$\frac{\Delta V_O}{V_O}$	Load Regulation		0.04		%	$I_L = 0.1\text{mA}$ to 150mA (Note 3)
$V_{IN} - V_O$	Dropout Voltage (Note 4)		17 80 115 140 165		mV	$I_L = 100\mu\text{A}$ $I_L = 20\text{mA}$ $I_L = 50\text{mA}$ $I_L = 100\text{mA}$ $I_L = 150\text{mA}$
I_{GND}	Quiescent Current		< 1		μA	$V_{ENABLE} \leq 0.7\text{V}$ (Shutdown)
I_{GND}	Ground Pin Current (Note 5)		80 160 350 720 1300		μA	$V_{ENABLE} \geq 2.0\text{V}$, $I_L = 100\mu\text{A}$ $I_L = 20\text{mA}$ $I_L = 50\text{mA}$ $I_L = 100\text{mA}$ $I_L = 150\text{mA}$
PSRR	Ripple Rejection		75		dB	
I_{LIMIT}	Current Limit		320		mA	$V_{OUT} = 0\text{V}$
$\frac{\Delta V_O}{\Delta P_D}$	Thermal Regulation		0.05		%/W	(Note 6)
e_{no}	Output Noise		260		nV/ $\sqrt{\text{Hz}}$	$I_L = 50\text{mA}$, $C_L = 4.7\mu\text{F}$, 0.01 μF from Ref BYP to ground
ENABLE INPUT						
V_{IL}	Input Voltage Level Logic Low Logic High	2.0	0.4		V	OFF ON
I_L I_{IH}	ENABLE Input Current		0.01 2		μA	$V_{IL} \leq 0.18\text{V}$ $V_{IH} \geq 2.0\text{V}$

Note 1: Absolute maximum ratings indicate limits beyond which damage to the components may occur. Electrical specifications do not apply when operating the device outside of its rated operating conditions. The maximum allowable power dissipation is a function of the maximum junction temperature, $T_{J(MAX)}$, the junction-to-ambient thermal resistance, θ_{JA} , and the ambient temperature, T_A . The maximum allowable power dissipation at any ambient temperature is calculated using: $P_{(MAX)} = (T_{J(MAX)} - T_A) \theta_{JA}$. Exceeding the maximum allowable power dissipation will result in excessive die temperature, and the regulator will go into thermal shutdown. The θ_{JA} of the MIC5205-xxBM5 (all versions) is 250°C/W mounted on a PC board.

Note 2: Output voltage temperature coefficient is defined as the worst case voltage change divided by the total temperature range.

Note 3: Regulation is measured at constant junction temperature using low duty cycle pulse testing. Parts are tested for load regulation in the load range for 0.1mA to 150mA.

Note 4: Dropout Voltage is defined as the input to output differential at which the output voltage drops 2% below its normal value measured at 1V differential.

Note 5: Ground pin current is the regulator quiescent current plus pass transistor base current. The total current drawn from the supply is the sum of the load current plus the ground pin current.

Note 6: Thermal regulation is defined as the change in output voltage at a time T after a change in power dissipation is applied, excluding load or line regulation effects. Specifications are for a 150mA load pulse at $V_{IN} = 16V$ for $T = 10ms$.