

To all our customers

Regarding the change of names mentioned in the document, such as Mitsubishi Electric and Mitsubishi XX, to Renesas Technology Corp.

The semiconductor operations of Hitachi and Mitsubishi Electric were transferred to Renesas Technology Corporation on April 1st 2003. These operations include microcomputer, logic, analog and discrete devices, and memory chips other than DRAMs (flash memory, SRAMs etc.) Accordingly, although Mitsubishi Electric, Mitsubishi Electric Corporation, Mitsubishi Semiconductors, and other Mitsubishi brand names are mentioned in the document, these names have in fact all been changed to Renesas Technology Corp. Thank you for your understanding. Except for our corporate trademark, logo and corporate statement, no changes whatsoever have been made to the contents of the document, and these changes do not constitute any alteration to the contents of the document itself.

Note : Mitsubishi Electric will continue the business operations of high frequency & optical devices and power devices.

Renesas Technology Corp.
Customer Support Dept.
April 1, 2003

FY4ADJ-03A

HIGH-SPEED SWITCHING USE

FY4ADJ-03A

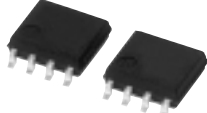

- 4V DRIVE
- V_{DSS} -30V
- $r_{DS(ON)}$ (MAX) 80m Ω
- I_D -4A

OUTLINE DRAWING Dimensions in mm

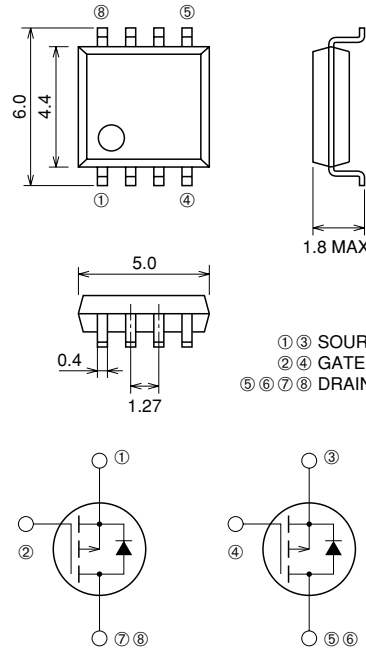

① ③ SOURCE
② ④ GATE
⑤ ⑥ ⑦ ⑧ DRAIN

SOP-8

APPLICATION

Motor control, Lamp control, Solenoid control
DC-DC converter, etc.

MAXIMUM RATINGS ($T_c = 25^\circ\text{C}$)

Symbol	Parameter	Conditions	Ratings	Unit
V_{DSS}	Drain-source voltage	$V_{GS} = 0V$	-30	V
V_{GSS}	Gate-source voltage	$V_{DS} = 0V$	± 20	V
I_D	Drain current		-4	A
I_{DM}	Drain current (Pulsed)		-28	A
I_{DA}	Avalanche drain current (Pulsed)	$L = 10\mu H$	-4	A
I_S	Source current		-1.7	A
I_{SM}	Source current (Pulsed)		-6.8	A
P_D	Maximum power dissipation		1.6	W
T_{ch}	Channel temperature		-55 ~ +150	$^\circ\text{C}$
T_{stg}	Storage temperature		-55 ~ +150	$^\circ\text{C}$
—	Weight	Typical value	0.07	g

ELECTRICAL CHARACTERISTICS (T_{ch} = 25°C)

Symbol	Parameter	Test conditions	Limits			Unit
			Min.	Typ.	Max.	
V _{(BR)DSS}	Drain-source breakdown voltage	I _D = -1mA, V _{GS} = 0V	-30	—	—	V
I _{GSS}	Gate-source leakage current	V _{GS} = ±20V, V _{DS} = 0V	—	—	±0.1	μA
I _{DSS}	Drain-source leakage current	V _{DS} = -30V, V _{GS} = 0V	—	—	-0.1	mA
V _{GS(th)}	Gate-source threshold voltage	I _D = -1mA, V _{DS} = 10V	-1.5	-2.0	-2.5	V
r _{DS(ON)}	Drain-source on-state resistance	I _D = -4A, V _{GS} = -10V	—	60	80	mΩ
r _{DS(ON)}	Drain-source on-state resistance	I _D = -2A, V _{GS} = -4V	—	115	180	mΩ
V _{DS(ON)}	Drain-source on-state voltage	I _D = -4A, V _{GS} = -10V	—	-0.24	-0.32	V
y _{fs}	Forward transfer admittance	I _D = -4A, V _{DS} = -10V	—	6	—	S
C _{iss}	Input capacitance	V _{DS} = -10V, V _{GS} = 0V, f = 1MHz	—	680	—	pF
C _{oss}	Output capacitance		—	180	—	pF
C _{rss}	Reverse transfer capacitance		—	90	—	pF
t _{d(on)}	Turn-on delay time		—	10	—	ns
t _r	Rise time	V _{DD} = -15V, I _D = -2A, V _{GS} = -10V, R _{GEN} = R _{GS} = 50Ω	—	15	—	ns
t _{d(off)}	Turn-off delay time		—	50	—	ns
t _f	Fall time		—	30	—	ns
V _{SD}	Source-drain voltage		I _S = -1.7A, V _{GS} = 0V	—	-0.88	-1.20
R _{th(ch-a)}	Thermal resistance	Channel to ambient	—	—	78.1	°C/W
t _{rr}	Reverse recovery time	I _S = -1.7A, dis/dt = 50A/μs	—	70	—	ns

PERFORMANCE CURVES

POWER DISSIPATION DERATING CURVE

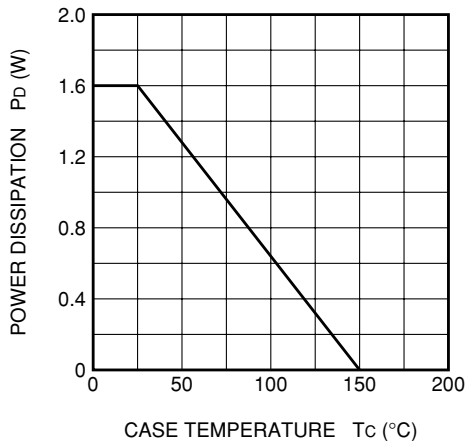

MAXIMUM SAFE OPERATING AREA

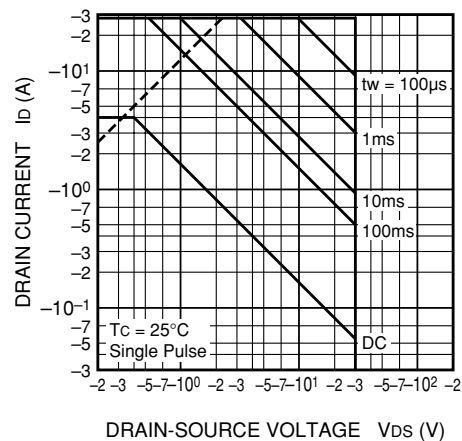

OUTPUT CHARACTERISTICS (TYPICAL)

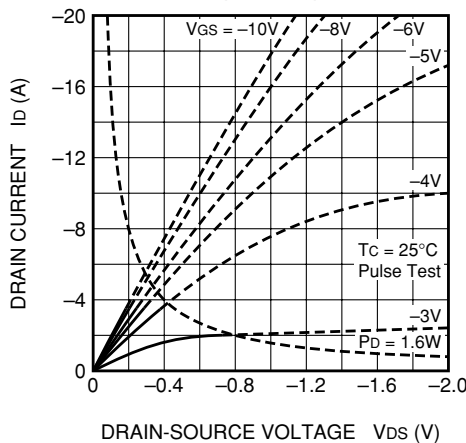

OUTPUT CHARACTERISTICS (TYPICAL)

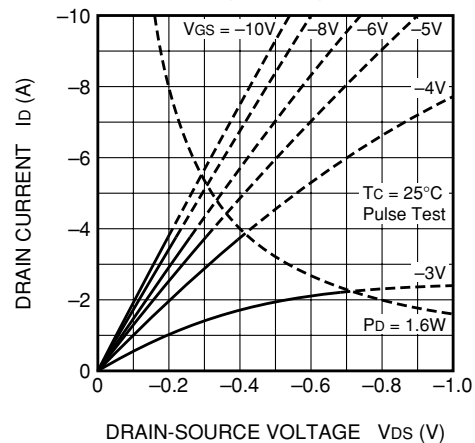

ON-STATE VOLTAGE VS. GATE-SOURCE VOLTAGE (TYPICAL)

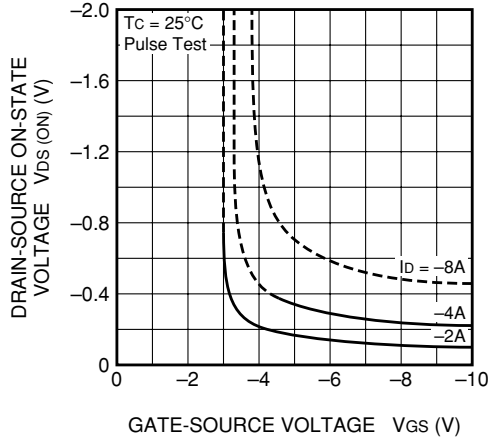

ON-STATE RESISTANCE VS. DRAIN CURRENT (TYPICAL)

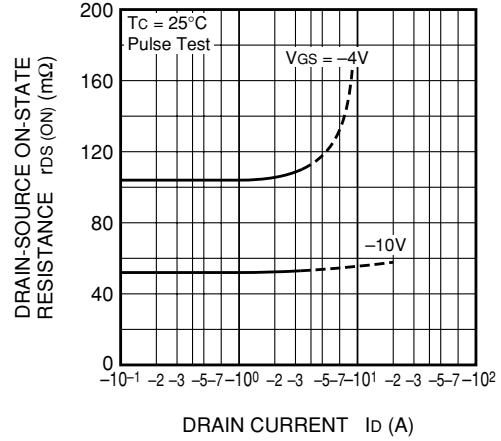

TRANSFER CHARACTERISTICS (TYPICAL)

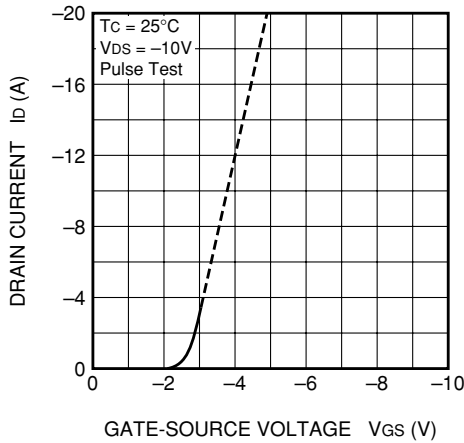

FORWARD TRANSFER ADMITTANCE VS. DRAIN CURRENT (TYPICAL)

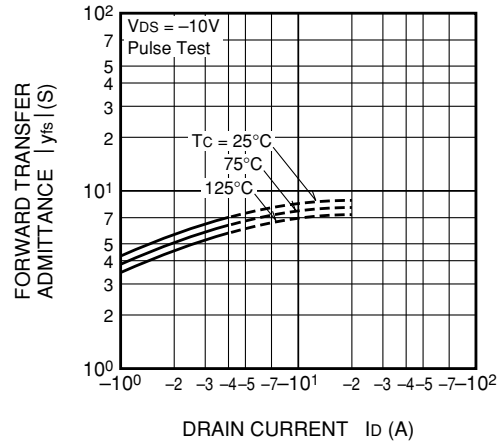

CAPACITANCE VS. DRAIN-SOURCE VOLTAGE (TYPICAL)

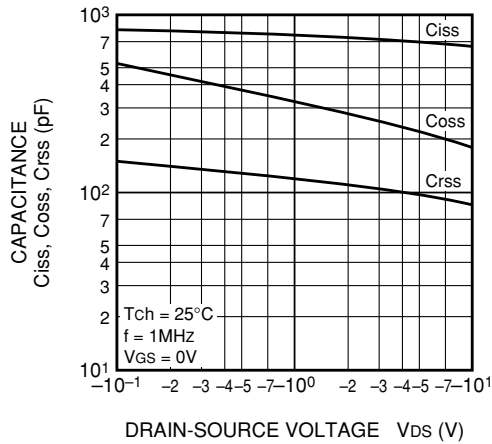

SWITCHING CHARACTERISTICS (TYPICAL)

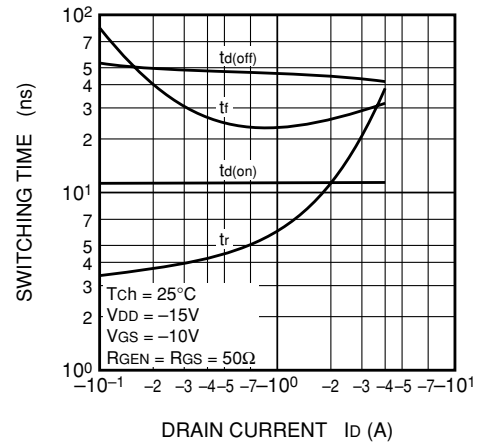

GATE-SOURCE VOLTAGE VS. GATE CHARGE (TYPICAL)

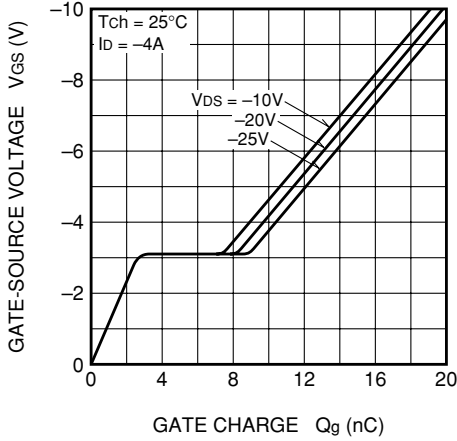

SOURCE-DRAIN DIODE FORWARD CHARACTERISTICS (TYPICAL)

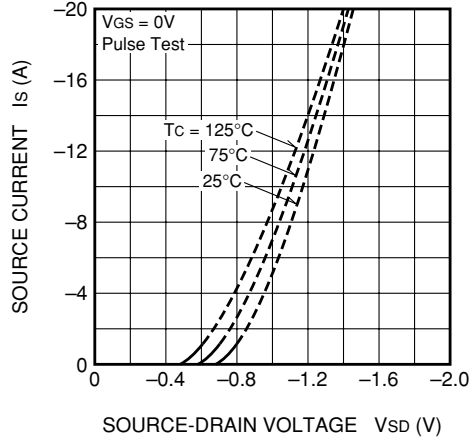

ON-STATE RESISTANCE VS. CHANNEL TEMPERATURE (TYPICAL)

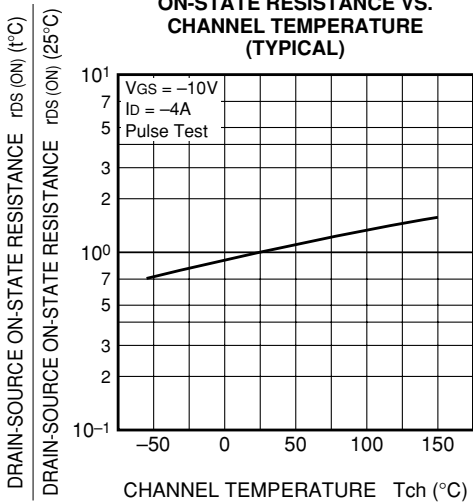

THRESHOLD VOLTAGE VS. CHANNEL TEMPERATURE (TYPICAL)

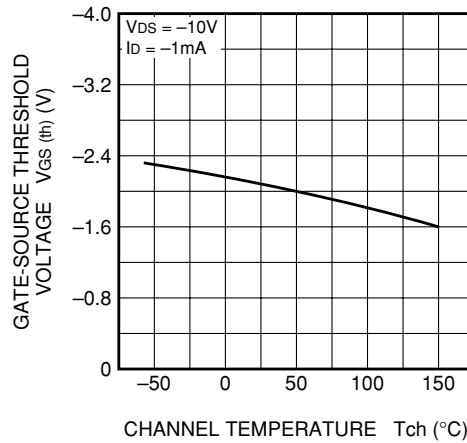

BREAKDOWN VOLTAGE VS. CHANNEL TEMPERATURE (TYPICAL)

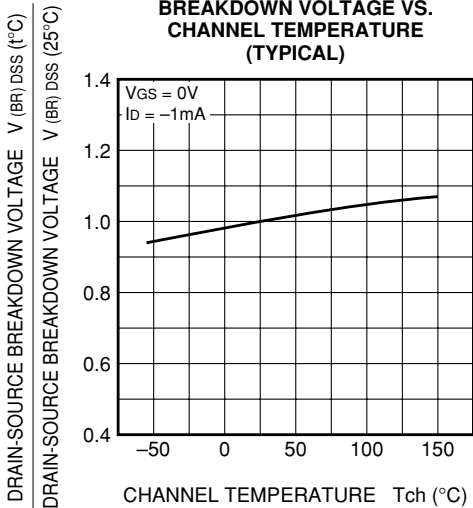

TRANSIENT THERMAL IMPEDANCE CHARACTERISTICS

