

Silicon Schottky Diode

- General-purpose diode for high-speed switching
- Circuit protection
- Voltage clamping
- High-level detection and mixing

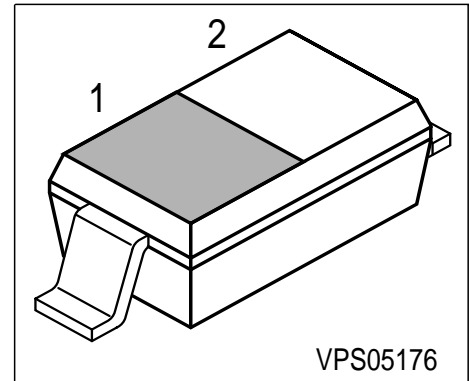

Type	Marking	Pin Configuration			Package
BAS170W	7	1 = C	2 = A	-	SOD323

Maximum Ratings

Parameter	Symbol	Value	Unit
Diode reverse voltage	V_R	70	V
Forward current	I_F	70	mA
Surge forward current, $t \leq 10$ ms	I_{FSM}	100	
Total power dissipation $T_S = 97$ °C	P_{tot}	250	mW
Junction temperature	T_j	150	°C
Operating temperature range	T_{op}	-55 ... 125	
Storage temperature	T_{stg}	-55 ... 150	

Thermal Resistance

Parameter	Symbol	Value	Unit
Junction - soldering point ¹⁾	R_{thJS}	≤ 190	K/W

¹⁾For calculation of R_{thJA} please refer to Application Note Thermal Resistance

Electrical Characteristics at $T_A = 25^\circ\text{C}$, unless otherwise specified

Parameter	Symbol	Values			Unit
		min.	typ.	max.	
DC Characteristics					
Breakdown voltage $I_{(BR)} = 10 \mu\text{A}$	$V_{(BR)}$	70	-	-	V
Reverse current $V_R = 50 \text{ V}$ $V_R = 70 \text{ V}$	I_R	- -	- -	0.1 10	μA
Forward voltage $I_F = 1 \text{ mA}$ $I_F = 10 \text{ mA}$ $I_F = 15 \text{ mA}$	V_F	300 600 750	375 705 880	410 750 1000	mV
AC Characteristics					
Diode capacitance- $V_R = 0 \text{ V}, f = 1 \text{ MHz}$	C_T	-	1.5	2	pF
Differential forward resistance $I_F = 5 \text{ mA}, f = 10 \text{ kHz}$	R_F	-	34	-	Ω
Charge carrier life time $I_F = 25 \text{ mA}$	τ_{rr}	-	-	100	ps
Series inductance	L_S	-	1.8	-	nH

Diode capacitance $C_T = f(V_R)$

$f = 1\text{MHz}$

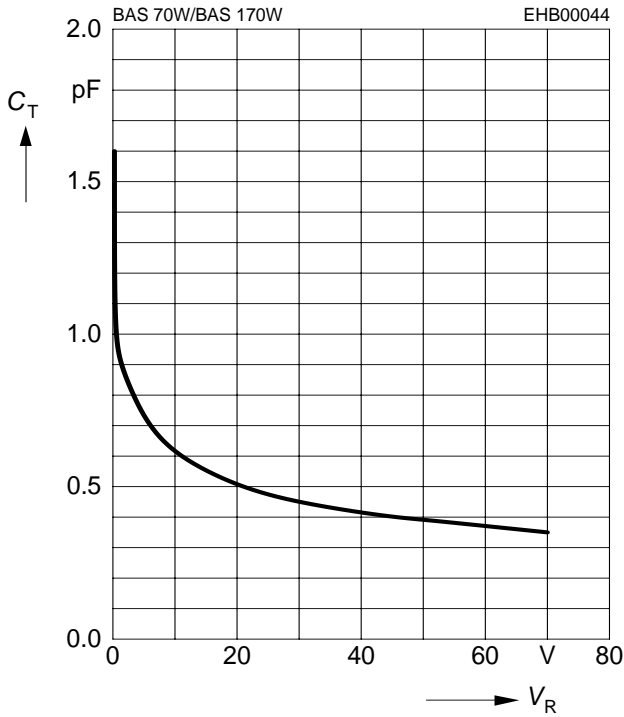

Differential forward resistance $r_f = f(I_F)$

$f = 10\text{kHz}$

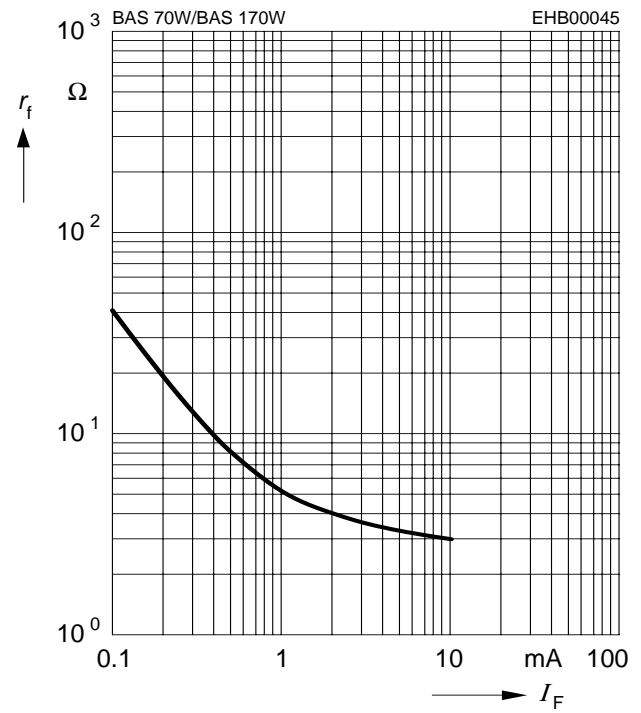

Reverse current $I_R = f(V_R)$

$T_A = \text{Parameter}$

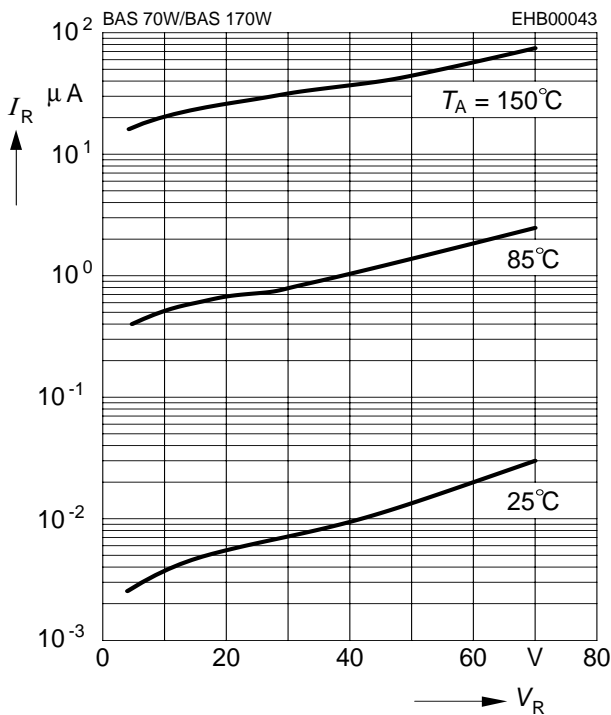

Forward current $I_F = f(T_S)$

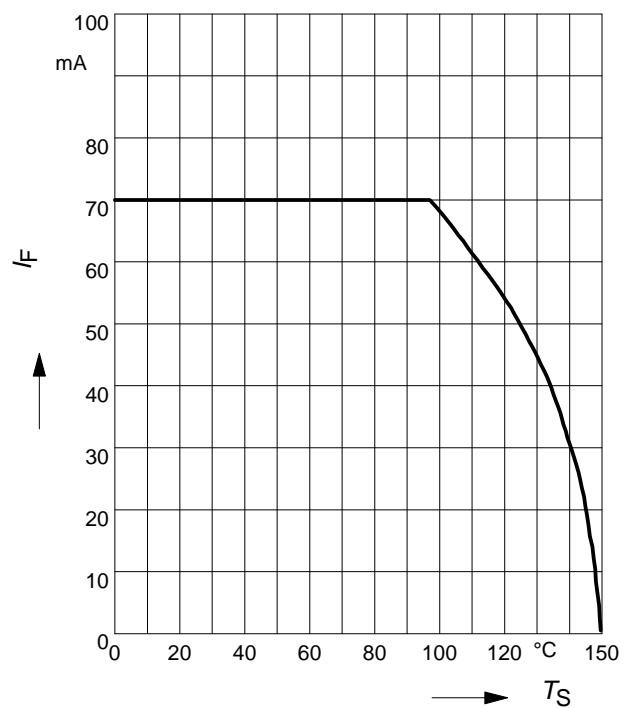

Forward current $I_F = f(V_F)$

$T_A = 25\text{ }^\circ\text{C}$

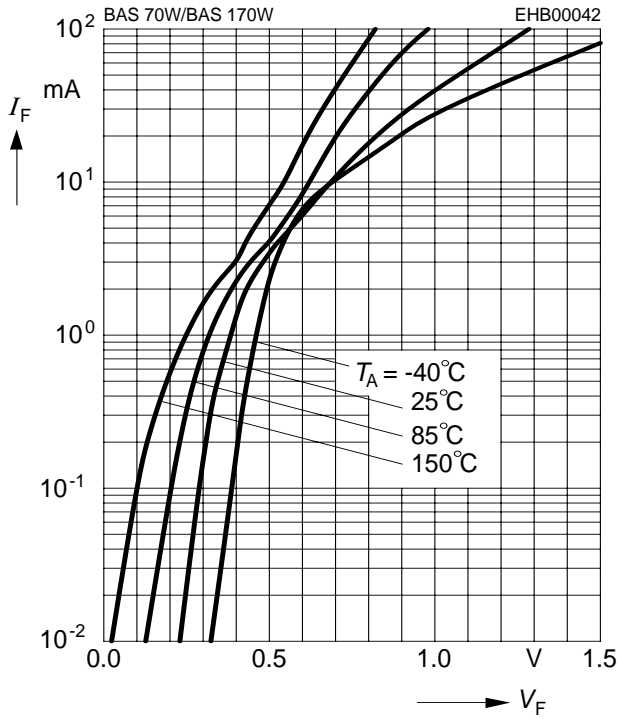

Permissible Pulse Load

$I_{Fmax}/I_{FDC} = f(t_p)$

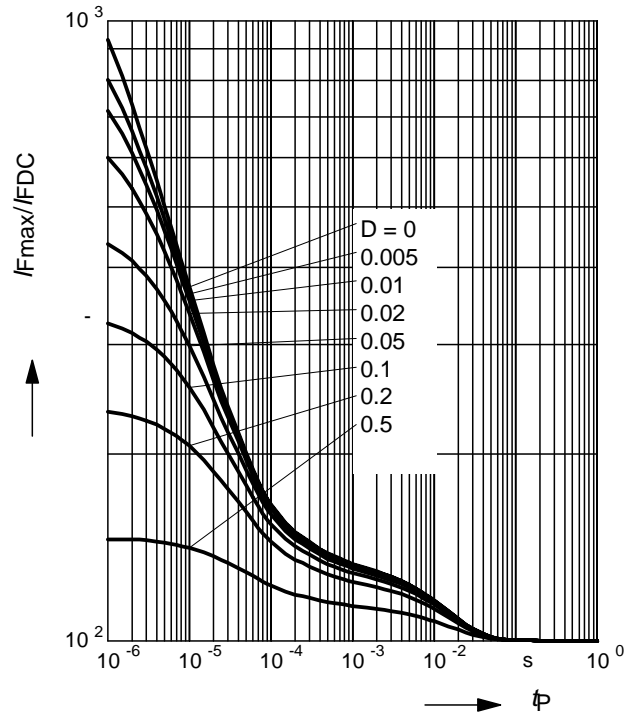

Permissible Puls Load $R_{thJS} = f(t_p)$

