

**Silicon Schottky Diodes**

- For mixer applications in the VHF / UHF range
- For high-speed switching applications

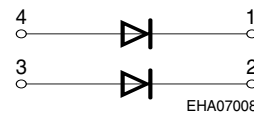
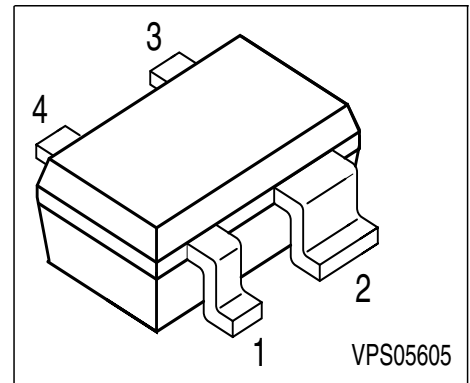

**ESD:** Electrostatic discharge sensitive device, observe handling precaution!

Type	Marking	Pin Configuration				Package
BAT 68-07W	87	1 = C1	2 = C2	3 = A2	4 = A1	SOT-343

**Maximum Ratings**

Parameter	Symbol	Value	Unit
Diode reverse voltage	$V_R$	8	V
Forward current	$I_F$	130	mA
Total power dissipation, $T_S = 89\text{ °C}$	$P_{tot}$	150	mW
Junction temperature	$T_j$	150	°C
Operating temperature range	$T_{op}$	-65 ... 150	°C
Storage temperature	$T_{stg}$	-65 ... 150	°C

**Maximum Ratings**

Junction - ambient <sup>1)</sup>	$R_{thJA}$	≤ 570	K/W
Junction - soldering point	$R_{thJS}$	≤ 410	

1) Package mounted on alumina 15mm x 17.6mm x 0.7mm

**Electrical Characteristics** at  $T_A = 25\text{ }^\circ\text{C}$ , unless otherwise specified.

Parameter	Symbol	Values			Unit
		min.	typ.	max.	
<b>DC characteristics</b>					
Breakdown voltage $I_{(BR)} = 10\text{ }\mu\text{A}$	$V_{(BR)}$	8	-	-	V
Reverse current $V_R = 1\text{ V}$	$I_R$	-	-	0.1	$\mu\text{A}$
Reverse current $V_R = 1\text{ V}, T_A = 60\text{ }^\circ\text{C}$	$I_R$	-	-	1.2	
Forward voltage $I_F = 1\text{ mA}$ $I_F = 10\text{ mA}$	$V_F$	- 340	318 390	340 500	mV
<b>AC characteristics</b>					
Diode capacitance $V_R = 1\text{ V}, f = 1\text{ MHz}$	$C_T$	-	-	1	pF
Differential forward resistance $I_F = 5\text{ mA}, f = 10\text{ kHz}$	$R_f$	-	-	10	$\Omega$

**Forward current  $I_F = f(T_A^*; T_S)$**

\* Package mounted on alumina

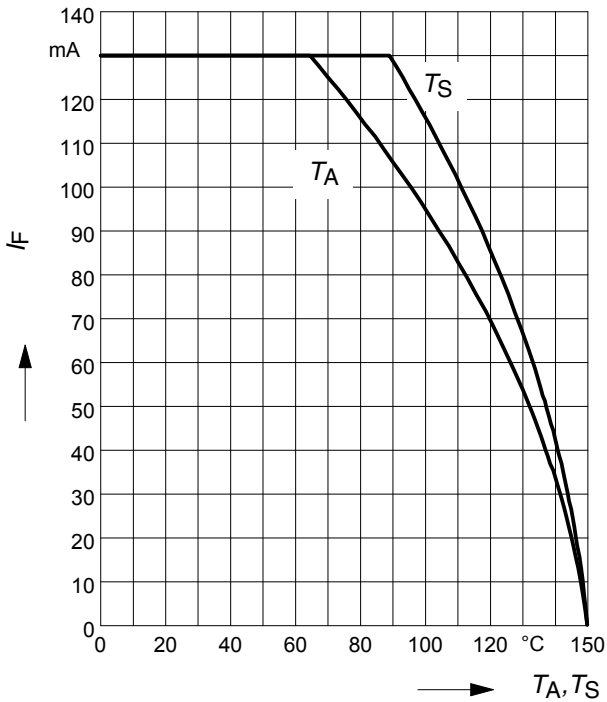

**Permissible Pulse Load  $R_{thJS} = f(t_p)$**

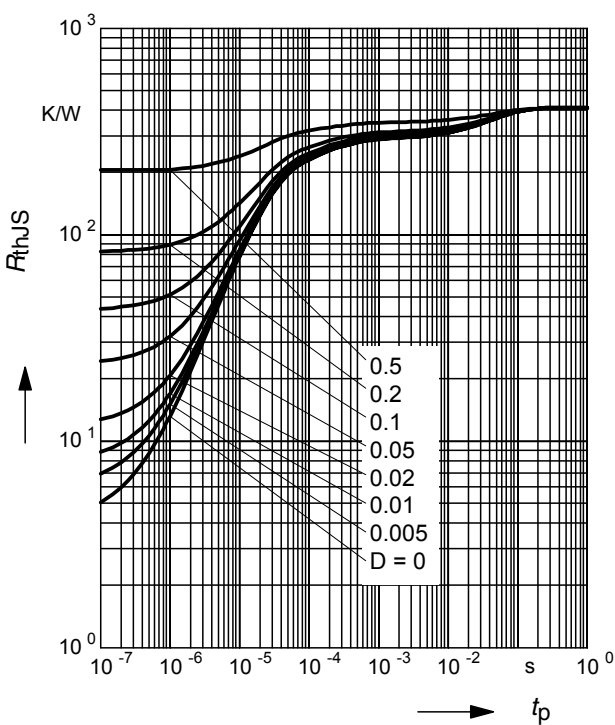

**Permissible Pulse Load**

$I_{Fmax} / I_{FDC} = f(t_p)$

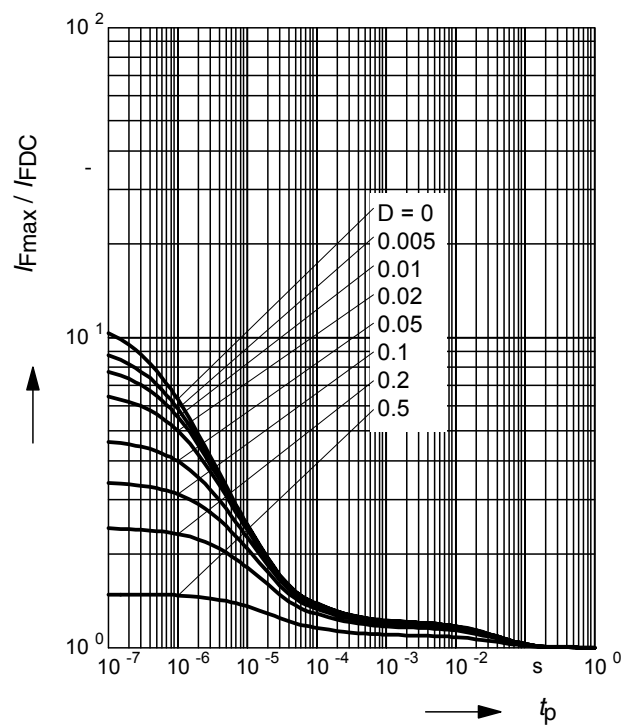

**Forward current  $I_F = f(V_F)$**

$T_A = \text{Parameter}$

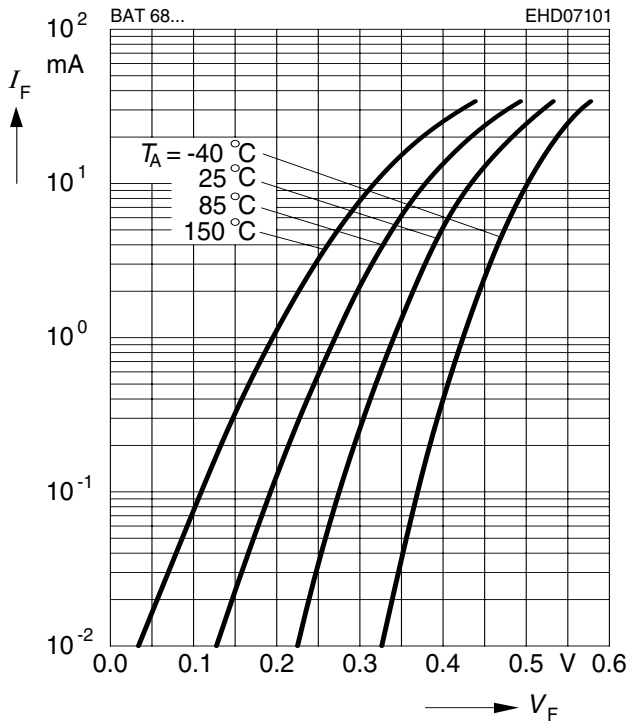

**Reverse current  $I_R = f(V_R)$**

$T_A = \text{Parameter}$

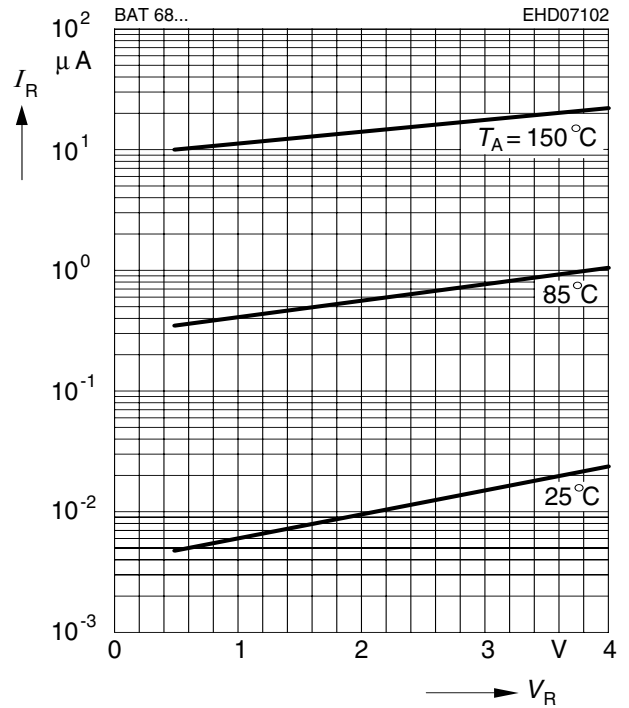

**Diode capacitance  $C_T = f(V_R)$**

$f = 1\text{MHz}$

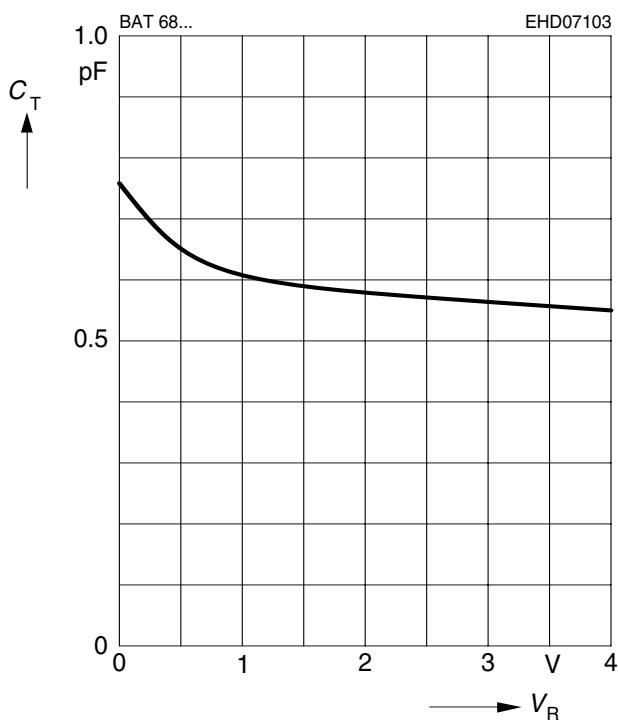

**Differential forward resistance  $r_f = f(I_F)$**

$f = 10\text{kHz}$

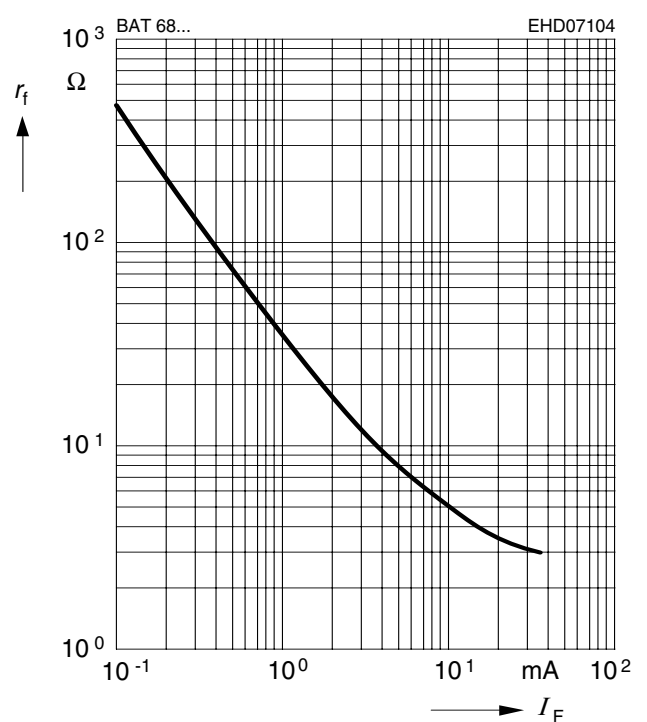

Rectifier voltage  $V_{out} = f(V_{in})$

$f = 900 \text{ MHz}$

$R_L = \text{parameter in } k\Omega$

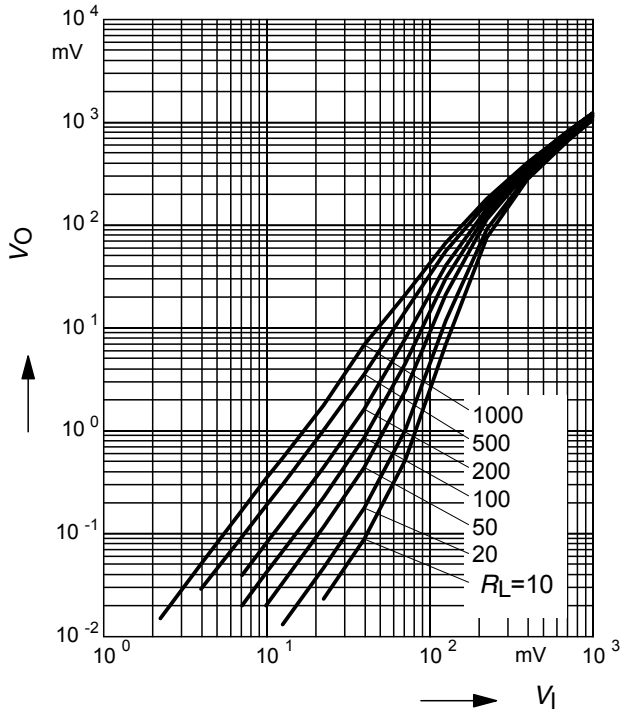

Testcircuit:

