

PNP Silicon Darlington Transistors

- For general AF applications
- High collector current
- High current gain
- Complementary types: BCV 27, BCV 47 (NPN)

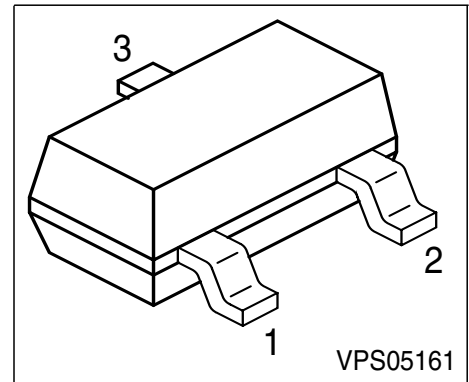

Type	Marking	Pin Configuration			Package
BCV 26	FDs	1 = B	2 = E	3 = C	SOT-23
BCV 46	FEs	1 = B	2 = E	3 = C	SOT-23

Maximum Ratings

Parameter	Symbol	BCV 26	BCV 46	Unit
Collector-emitter voltage	V_{CEO}	30	60	V
Collector-base voltage	V_{CBO}	40	80	
Emitter-base voltage	V_{EBO}	10	10	
DC collector current	I_C	500		mA
Peak collector current	I_{CM}	800		
Base current	I_B	100		
Peak base current	I_{BM}	200		
Total power dissipation, $T_S = 74\text{ °C}$	P_{tot}	360		mW
Junction temperature	T_j	150		°C
Storage temperature	T_{stg}	-65 ... 150		

Thermal Resistance

Junction ambient ¹⁾	R_{thJA}	≤280	K/W
Junction - soldering point	R_{thJS}	≤210	

1) Package mounted on pcb 40mm x 40mm x 1.5mm / 6cm² Cu

Electrical Characteristics at $T_A = 25^\circ\text{C}$, unless otherwise specified.

Parameter	Symbol	Values			Unit
		min.	typ.	max.	
DC Characteristics					
Collector-emitter breakdown voltage $I_C = 10\text{ mA}, I_B = 0$	$V_{(BR)CEO}$				V
BCP 26		30	-	-	
BCP 46		60	-	-	
Collector-base breakdown voltage $I_C = 100\ \mu\text{A}, I_B = 0$	$V_{(BR)CBO}$				
BCP 26		40	-	-	
BCP 46		80	-	-	
Emitter-base breakdown voltage $I_E = 10\ \mu\text{A}, I_C = 0$	$V_{(BR)EBO}$	10	-	-	
Collector cutoff current $V_{CB} = 30\text{ V}, I_E = 0$	I_{CBO}				nA
BCP 26		-	-	100	
$V_{CB} = 60\text{ V}, I_E = 0$				100	
Collector cutoff current $V_{CB} = 30\text{ V}, I_E = 0, T_A = 150^\circ\text{C}$	I_{CBO}				μA
BCP 26		-	-	10	
$V_{CB} = 60\text{ V}, I_E = 0, T_A = 150^\circ\text{C}$				10	
Emitter cutoff current $V_{EB} = 4\text{ V}, I_C = 0$	I_{EBO}	-	-	100	nA
DC current gain 1) $I_C = 100\ \mu\text{A}, V_{CE} = 1\text{ V}$	h_{FE}				-
BCP 26		4000	-	-	
BCP 46		2000	-	-	
DC current gain 1) $I_C = 10\text{ mA}, V_{CE} = 5\text{ V}$	h_{FE}				
BCP 26		10000	-	-	
BCP 46		4000	-	-	
DC current gain 1) $I_C = 100\text{ mA}, V_{CE} = 5\text{ V}$	h_{FE}				-
BCP 26		20000	-	-	
BCP 46		10000	-	-	
DC current gain 1) $I_C = 0.5\text{ A}, V_{CE} = 5\text{ V}$	h_{FE}				-
BCP 26		4000	-	-	
BCP 46		2000	-	-	

 1) Pulse test: $t \leq 300\ \mu\text{s}$, $D = 2\%$

Electrical Characteristics at $T_A = 25^\circ\text{C}$, unless otherwise specified.

Parameter	Symbol	Values			Unit
		min.	typ.	max.	
DC Characteristics					
Collector-emitter saturation voltage1) $I_C = 100\text{ mA}, I_B = 0.1\text{ mA}$	V_{CEsat}	-	-	1	V
Base-emitter saturation voltage 1) $I_C = 100\text{ mA}, I_B = 0.1\text{ mA}$	V_{BEsat}	-	-	1.5	
AC Characteristics					
Transition frequency $I_C = 50\text{ mA}, V_{CE} = 5\text{ V}, f = 100\text{ MHz}$	f_T	-	200	-	MHz
Collector-base capacitance $V_{CB} = 10\text{ V}, f = 1\text{ MHz}$	C_{cb}	-	4.5	-	pF

1) Pulse test: $t \leq 300\mu\text{s}$, $D = 2\%$

Total power dissipation $P_{tot} = f(T_A^*; T_S)$

* Package mounted on epoxy

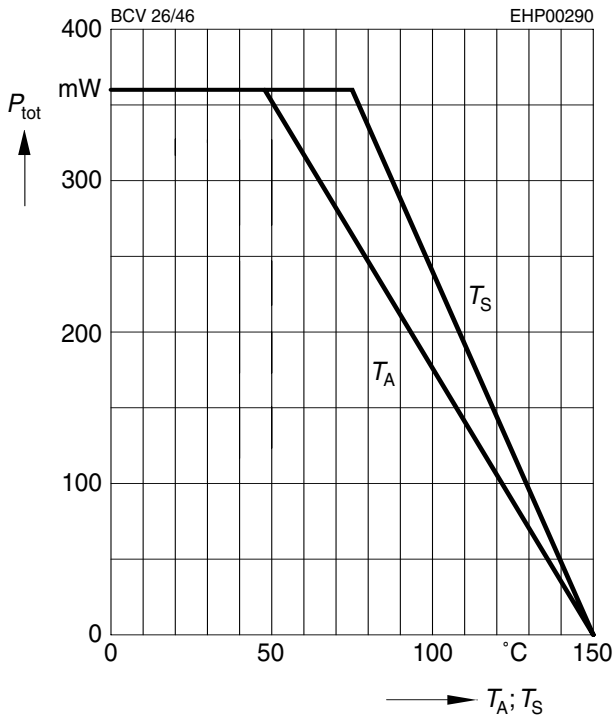

Collector-base capacitance $C_{CB} = f(V_{CB0})$

Emitter-base capacitance $C_{EB} = f(V_{EB0})$

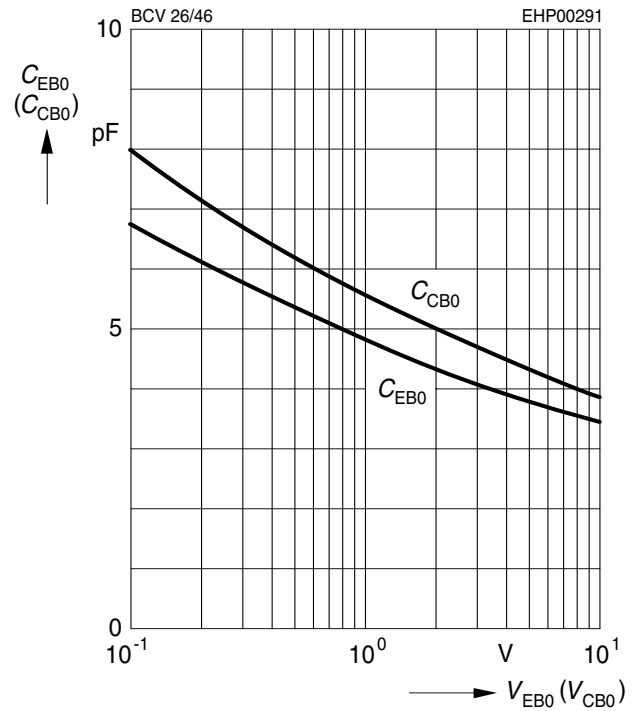

Permissible pulse load

$P_{totmax} / P_{totDC} = f(t_p)$

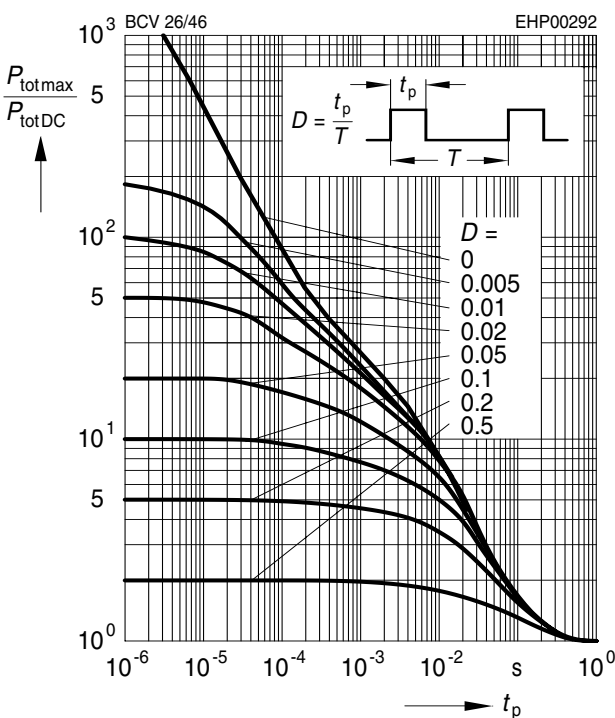

Transition frequency $f_T = f(I_C)$

$V_{CE} = 5V$

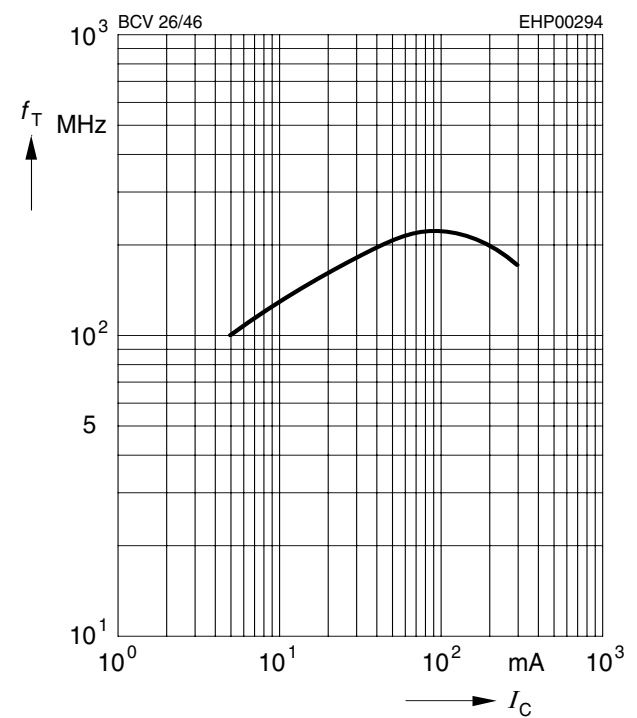

Base-emitter saturation voltage

$I_C = f(V_{BEsat}), h_{FE} = 1000$

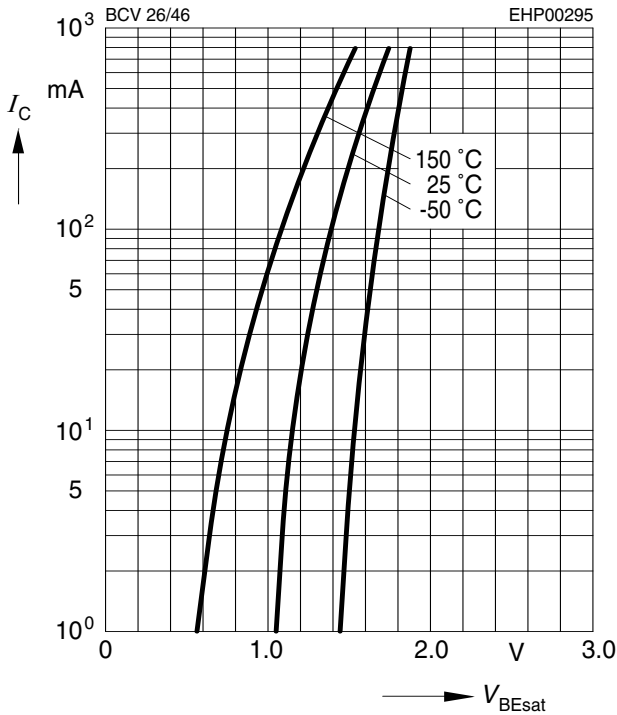

Collector-emitter saturation voltage

$I_C = f(V_{CEsat}), h_{FE} = 1000$

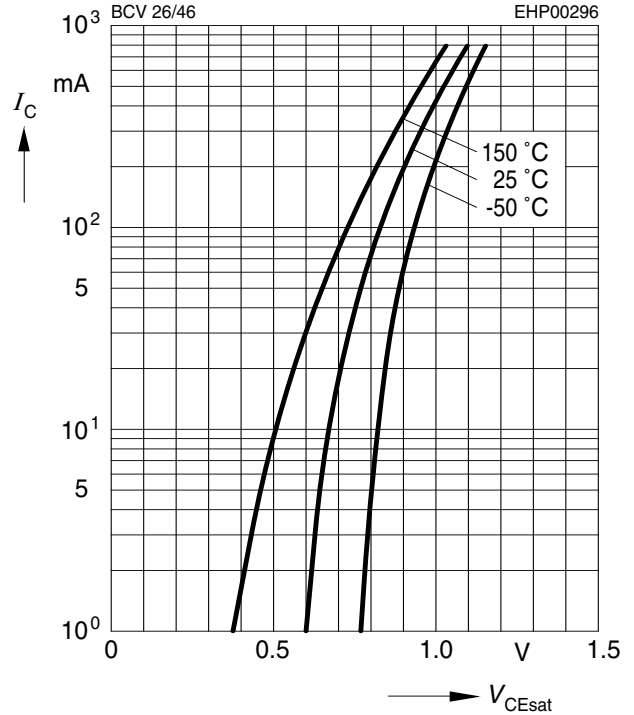

Collector cutoff current $I_{CBO} = f(T_A)$

$V_{CB} = V_{CEmax}$

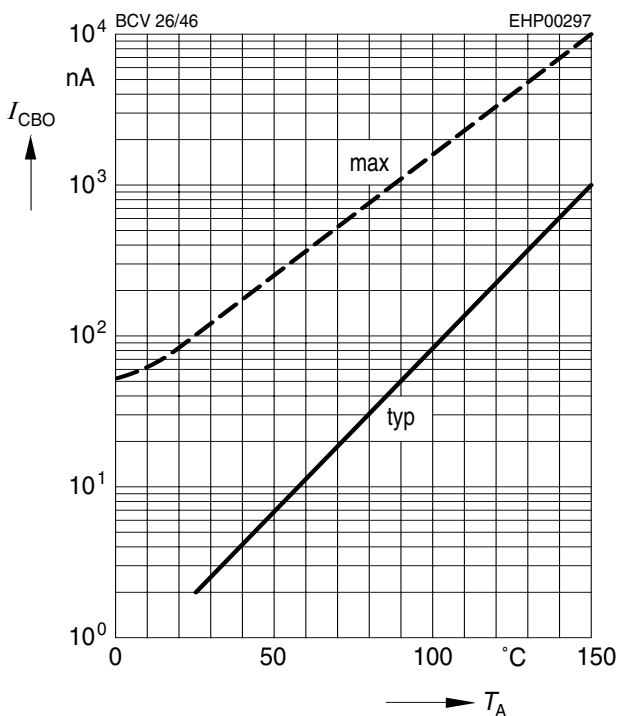

DC current gain $h_{FE} = f(I_C)$

$V_{CE} = 5V$

