

**NPN Silicon Darlington Transistors**

- For general AF applications
- High collector current
- High current gain
- Complementary types: BCV 26, BCV 46 (PNP)

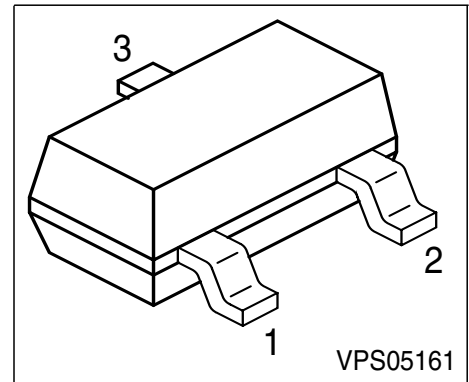

Type	Marking	Pin Configuration			Package
BCV 27	FFs	1 = B	2 = E	3 = C	SOT-23
BCV 47	FGs	1 = B	2 = E	3 = C	SOT-23

**Maximum Ratings**

Parameter	Symbol	BCV 27	BCV 47	Unit
Collector-emitter voltage	$V_{CEO}$	30	60	V
Collector-base voltage	$V_{CBO}$	40	80	
Emitter-base voltage	$V_{EBO}$	10	10	
DC collector current	$I_C$	500		mA
Peak collector current	$I_{CM}$	800		
Base current	$I_B$	100		
Peak base current	$I_{BM}$	200		mW
Total power dissipation, $T_S = 74\text{ °C}$	$P_{tot}$	360		
Junction temperature	$T_j$	150		
Storage temperature	$T_{stg}$	-65 ... 150		°C

**Thermal Resistance**

Junction ambient <sup>1)</sup>	$R_{thJA}$	≤280	K/W
Junction - soldering point	$R_{thJS}$	≤210	

1) Package mounted on pcb 40mm x 40mm x 1.5mm / 6cm<sup>2</sup> Cu

**Electrical Characteristics** at  $T_A = 25^\circ\text{C}$ , unless otherwise specified.

Parameter	Symbol	Values			Unit
		min.	typ.	max.	
<b>DC Characteristics</b>					
Collector-emitter breakdown voltage $I_C = 10\text{ mA}, I_B = 0$	$V_{(BR)CEO}$				V
BCP 27		30	-	-	
BCP 47		60	-	-	
Collector-base breakdown voltage $I_C = 100\ \mu\text{A}, I_B = 0$	$V_{(BR)CBO}$				
BCP 27		40	-	-	
BCP 47		80	-	-	
Emitter-base breakdown voltage $I_E = 10\ \mu\text{A}, I_C = 0$	$V_{(BR)EBO}$	10	-	-	
Collector cutoff current $V_{CB} = 30\text{ V}, I_E = 0$	$I_{CBO}$				nA
BCP 27		-	-	100	
$V_{CB} = 60\text{ V}, I_E = 0$	BCP 47			100	
Collector cutoff current $V_{CB} = 30\text{ V}, I_E = 0, T_A = 150^\circ\text{C}$	$I_{CBO}$				$\mu\text{A}$
BCP 27		-	-	10	
$V_{CB} = 60\text{ V}, I_E = 0, T_A = 150^\circ\text{C}$	BCP 47			10	
Emitter cutoff current $V_{EB} = 4\text{ V}, I_C = 0$	$I_{EBO}$	-	-	100	nA
DC current gain 1) $I_C = 100\ \mu\text{A}, V_{CE} = 1\text{ V}$	$h_{FE}$				-
BCP 27		4000	-	-	
BCP 47		2000	-	-	
DC current gain 1) $I_C = 10\text{ mA}, V_{CE} = 5\text{ V}$	$h_{FE}$				-
BCP 27		10000	-	-	
BCP 47		4000	-	-	
DC current gain 1) $I_C = 100\text{ mA}, V_{CE} = 5\text{ V}$	$h_{FE}$				-
BCP 27		20000	-	-	
BCP 47		10000	-	-	
DC current gain 1) $I_C = 0.5\text{ A}, V_{CE} = 5\text{ V}$	$h_{FE}$				-
BCP 27		4000	-	-	
BCP 47		2000	-	-	

 1) Pulse test:  $t \leq 300\ \mu\text{s}$ ,  $D = 2\%$

**Electrical Characteristics** at  $T_A = 25^\circ\text{C}$ , unless otherwise specified.

Parameter	Symbol	Values			Unit
		min.	typ.	max.	
<b>DC Characteristics</b>					
Collector-emitter saturation voltage <sup>1)</sup> $I_C = 100\text{ mA}, I_B = 0.1\text{ mA}$	$V_{CEsat}$	-	-	1	V
Base-emitter saturation voltage <sup>1)</sup> $I_C = 100\text{ mA}, I_B = 0.1\text{ mA}$	$V_{BEsat}$	-	-	1.5	
<b>AC Characteristics</b>					
Transition frequency $I_C = 50\text{ mA}, V_{CE} = 5\text{ V}, f = 100\text{ MHz}$	$f_T$	-	170	-	MHz
Collector-base capacitance $V_{CB} = 10\text{ V}, f = 1\text{ MHz}$	$C_{cb}$	-	3.5	-	pF

1) Pulse test:  $t \leq 300\mu\text{s}$ ,  $D = 2\%$

**Total power dissipation  $P_{tot} = f(T_A^*; T_S)$**

\* Package mounted on epoxy

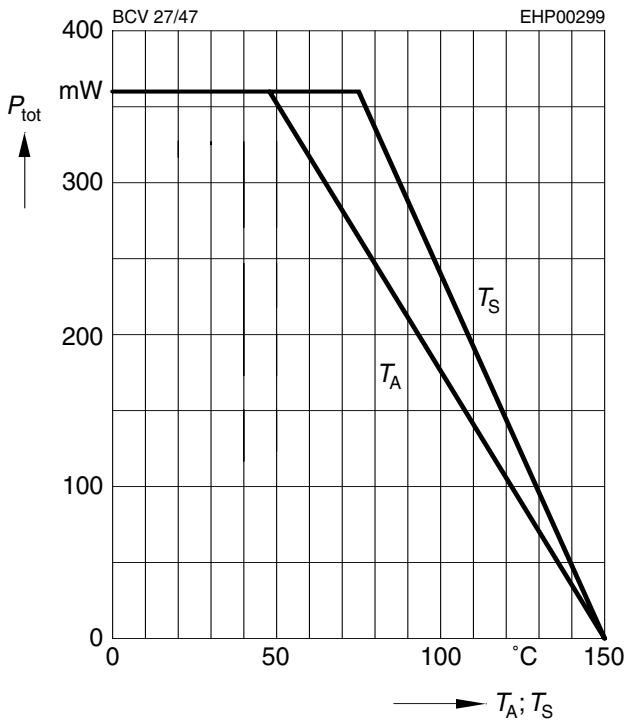

**Collector-base capacitance  $C_{CB} = f(V_{CB0})$**

**Emitter-base capacitance  $C_{EB} = f(V_{EB0})$**

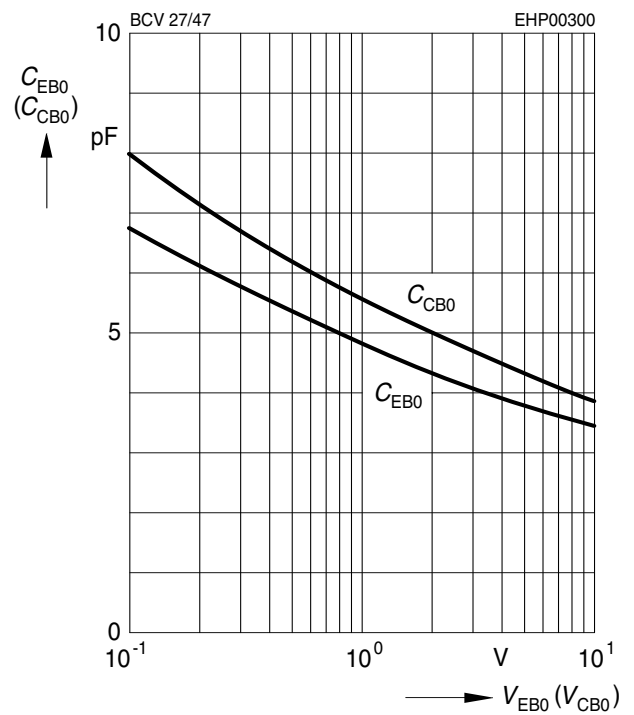

**Permissible pulse load**

$P_{totmax} / P_{totDC} = f(t_p)$

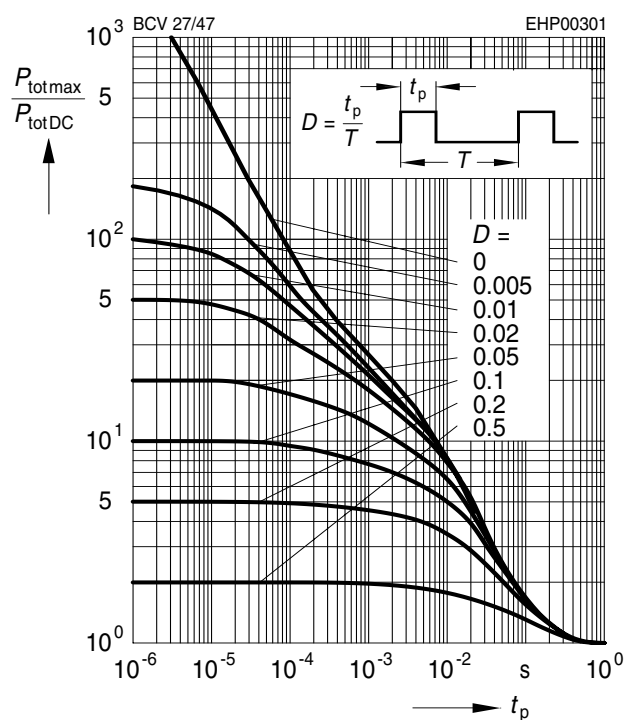

**Transition frequency  $f_T = f(I_C)$**

$V_{CE} = 5V$

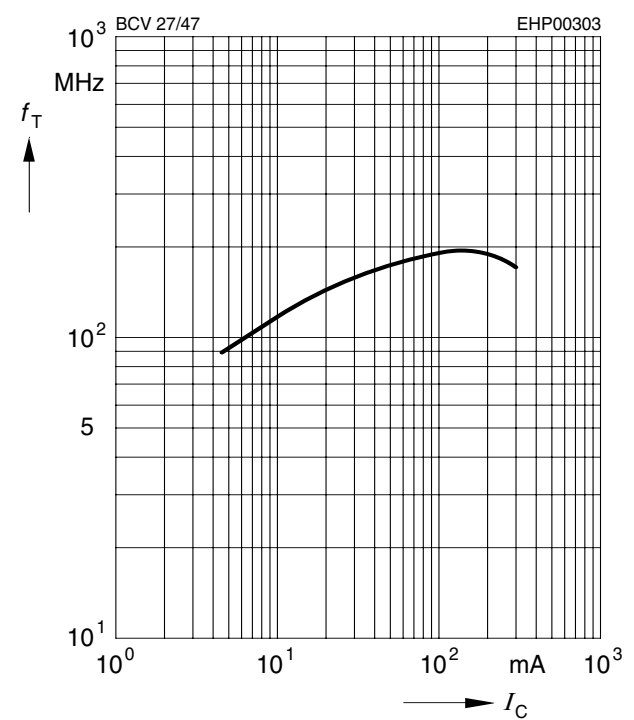

**Base-emitter saturation voltage**

$I_C = f(V_{BEsat}), h_{FE} = 1000$

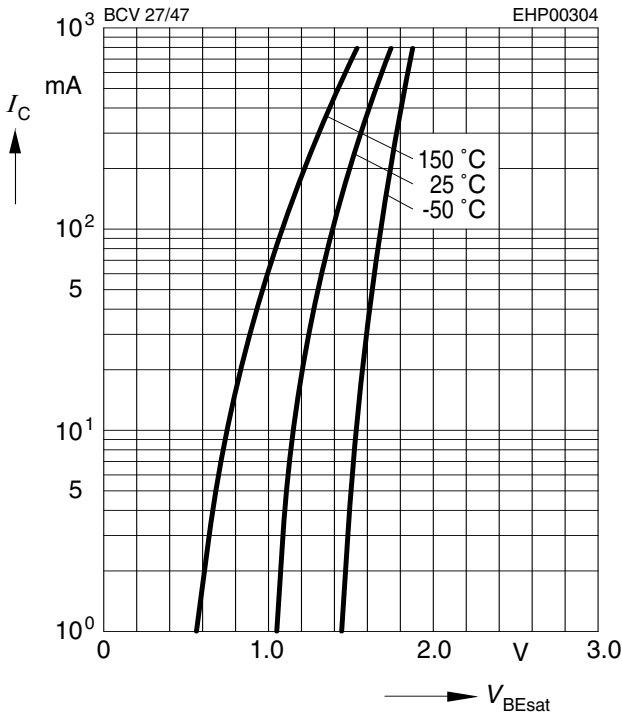

**Collector-emitter saturation voltage**

$I_C = f(V_{CEsat}), h_{FE} = 1000$

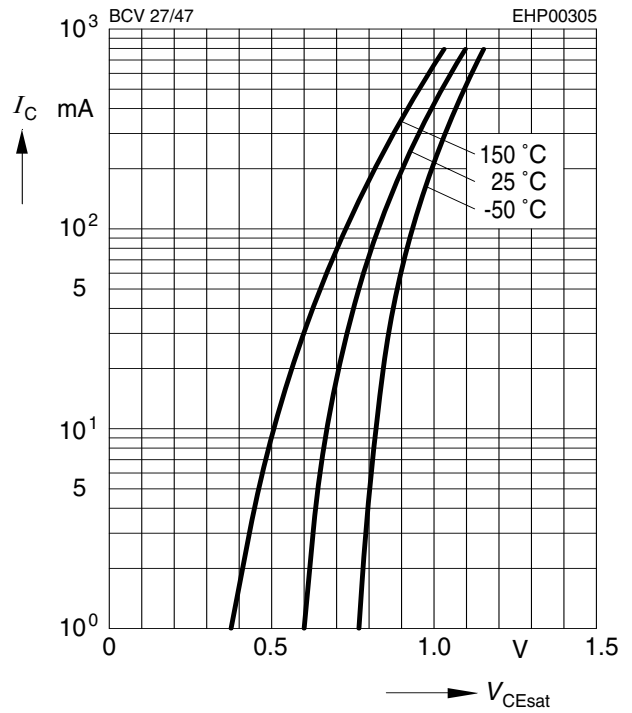

**Collector cutoff current  $I_{CBO} = f(T_A)$**

$V_{CB} = V_{CEmax}$

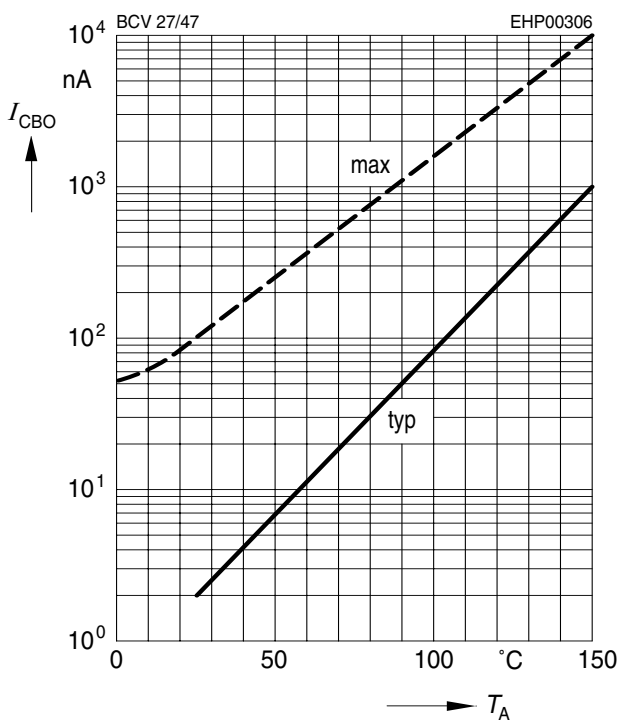

**DC current gain  $h_{FE} = f(I_C)$**

$V_{CE} = 5V$

