

PNP Silicon AF Transistors

- For general AF applications
- High collector current
- High current gain
- Low collector-emitter saturation voltage
- Complementary type: BCX 68 (NPN)

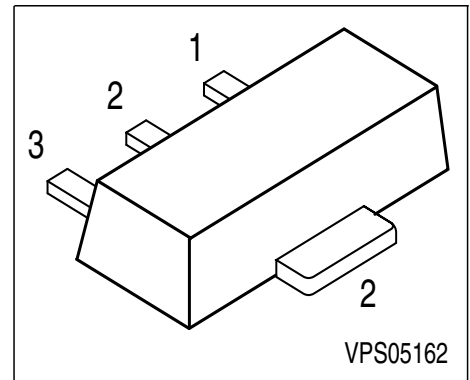

Type	Marking	Pin Configuration			Package
BCX 69	CE	1 = B	2 = C	3 = E	SOT-89
BCX 69-10	CF	1 = B	2 = C	3 = E	SOT-89
BCX 69-16	CG	1 = B	2 = C	3 = E	SOT-89
BCX 69-25	CH	1 = B	2 = C	3 = E	SOT-89

Maximum Ratings

Parameter	Symbol	Values	Unit
Collector-emitter voltage	V_{CEO}	20	V
Collector-base voltage	V_{CBO}	25	
Emitter-base voltage	V_{EBO}	5	
DC collector current	I_C	1	A
Peak collector current	I_{CM}	2	
Base current	I_B	100	mA
Peak base current	I_{BM}	200	
Total power dissipation, $T_S = 130\text{ °C}$	P_{tot}	1	W
Junction temperature	T_j	150	°C
Storage temperature	T_{stg}	-65 ... 150	

Thermal Resistance

Junction ambient ¹⁾	R_{thJA}	≤75	K/W
Junction - soldering point	R_{thJS}	≤20	

1) Package mounted on pcb 40mm x 40mm x 1.5mm / 6cm² Cu

Electrical Characteristics at $T_A = 25^\circ\text{C}$, unless otherwise specified.

Parameter	Symbol	Values			Unit
		min.	typ.	max.	
Characteristics					
Collector-emitter breakdown voltage $I_C = 30\text{ mA}, I_B = 0$	$V_{(BR)CEO}$	20	-	-	V
Collector-base breakdown voltage $I_C = 10\text{ }\mu\text{A}, I_B = 0$	$V_{(BR)CBO}$	25	-	-	
Emitter-base breakdown voltage $I_E = 1\text{ }\mu\text{A}, I_C = 0$	$V_{(BR)EBO}$	5	-	-	
Collector cutoff current $V_{CB} = 25\text{ V}, I_E = 0$	I_{CBO}	-	-	100	nA
Collector cutoff current $V_{CB} = 25\text{ V}, I_E = 0, T_A = 150\text{ }^\circ\text{C}$	I_{CBO}	-	-	100	μA
DC current gain 1) $I_C = 5\text{ mA}, V_{CE} = 10\text{ V}$	h_{FE}	50	-	-	-
DC current gain 1) $I_C = 500\text{ mA}, V_{CE} = 1\text{ V}$	h_{FE}				
	BCX 69	85	-	375	
	BCX 69-10	85	100	160	
	BCX 69-16	100	160	250	
	BCX 69-25	160	250	375	
DC current gain 1) $I_C = 1\text{ A}, V_{CE} = 1\text{ V}$	h_{FE}	60	-	-	
Collector-emitter saturation voltage1) $I_C = 1\text{ A}, I_B = 100\text{ mA}$	V_{CEsat}	-	-	0.5	V
Base-emitter voltage 1) $I_C = 5\text{ mA}, V_{CE} = 10\text{ V}$ $I_C = 1\text{ A}, V_{CE} = 1\text{ V}$	$V_{BE(ON)}$	-	0.6	-	
		-	-	1	
AC Characteristics					
Transition frequency $I_C = 100\text{ mA}, V_{CE} = 5\text{ V}, f = 20\text{ MHz}$	f_T	-	100	-	MHz

 1) Pulse test: $t \leq 300\mu\text{s}$, $D = 2\%$

Total power dissipation $P_{tot} = f(T_A^*; T_S)$

* Package mounted on epoxy

Transition frequency $f_T = f(I_C)$

$V_{CE} = 5V$

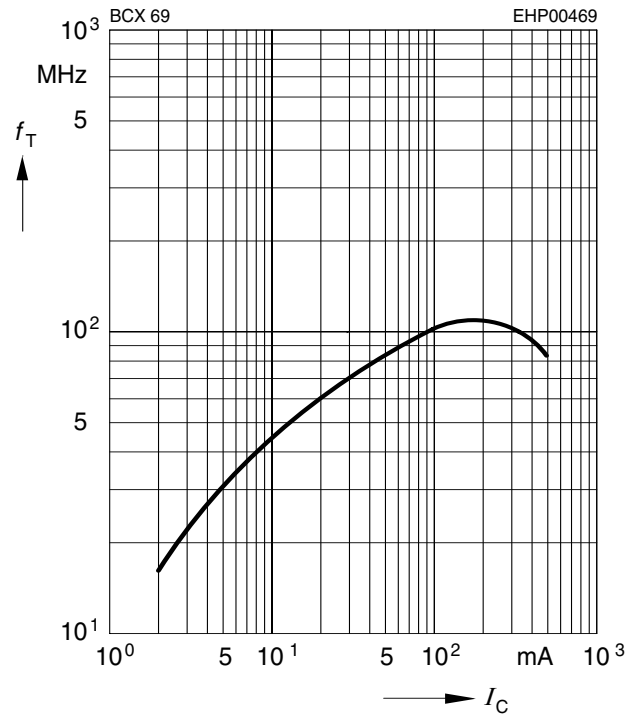
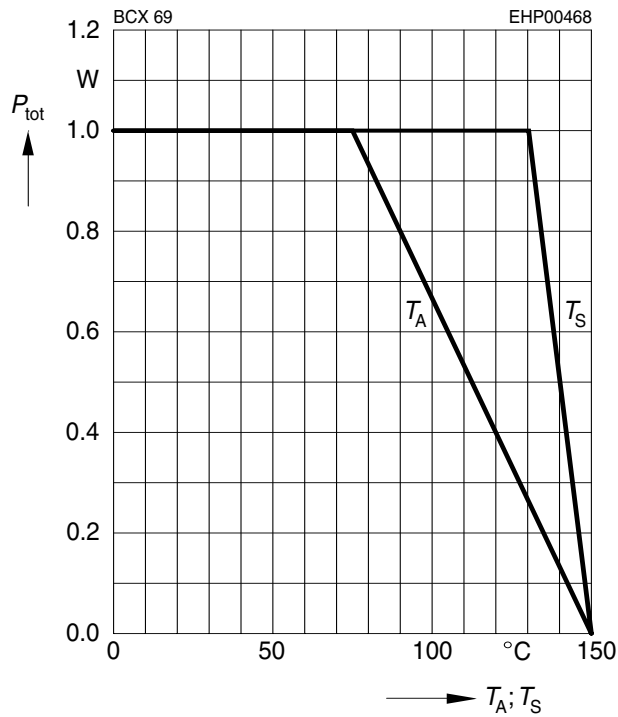

Permissible pulse load

$P_{totmax} / P_{totDC} = f(t_p)$

Collector cutoff current $I_{CBO} = f(T_A)$

$V_{CB} = 25V$

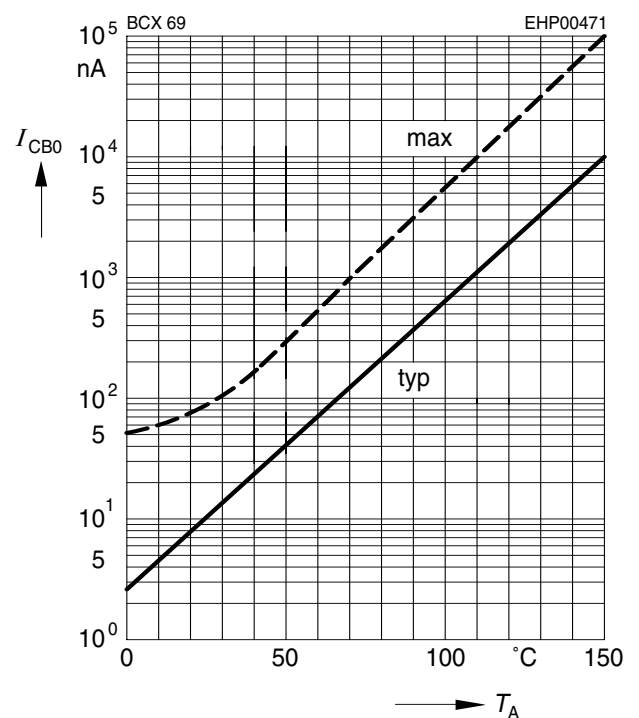
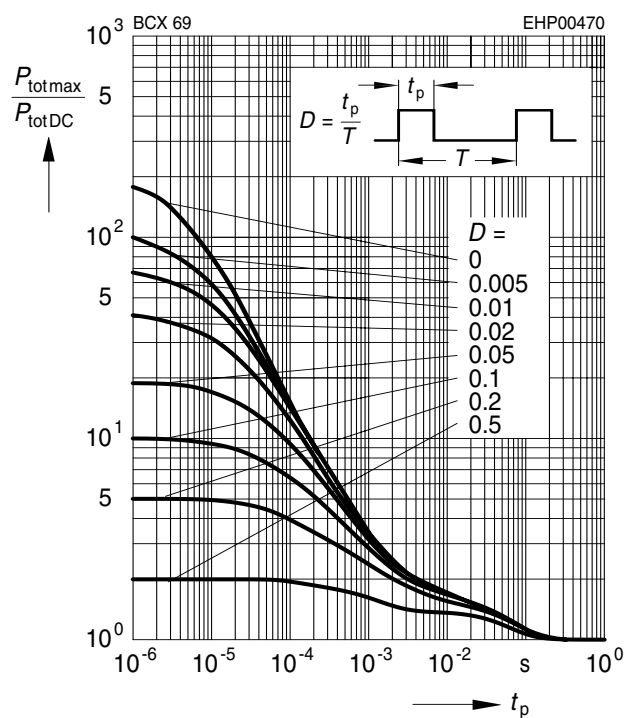

Base-emitter saturation voltage

$I_C = f(V_{BEsat}), h_{FE} = 10$

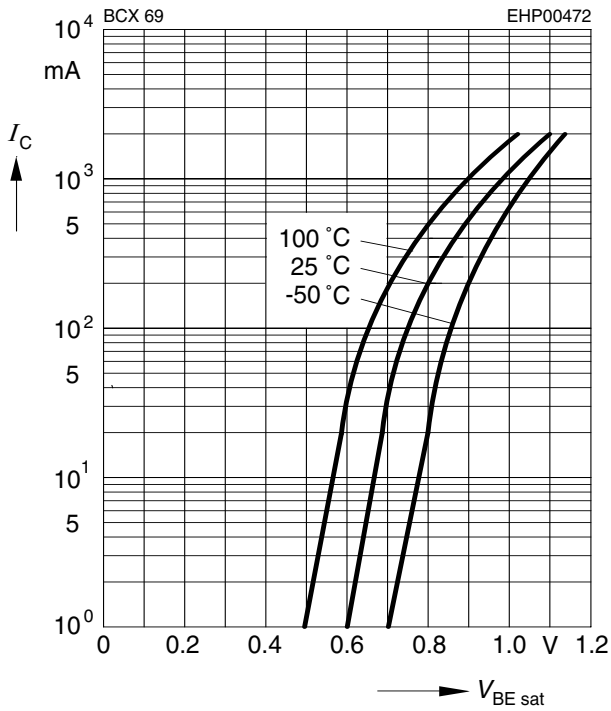

Collector-emitter saturation voltage

$I_C = f(V_{CEsat}), h_{FE} = 10$

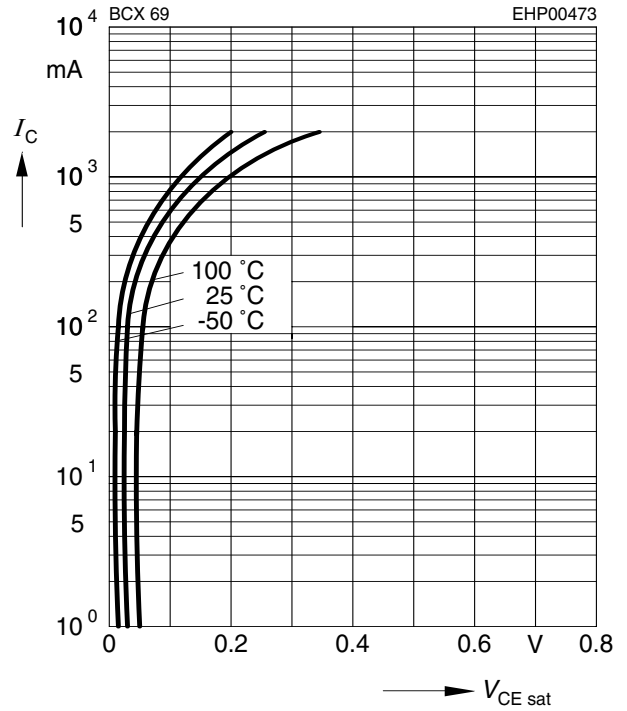

Collector current $I_C = f(V_{BE})$

$V_{CE} = 1V$

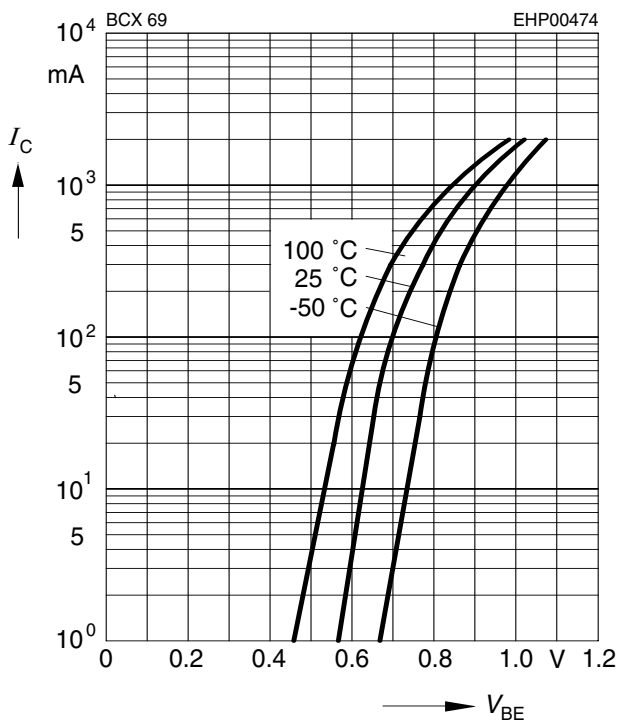

DC current gain $h_{FE} = f(I_C)$

$V_{CE} = 1V$

