

PNP Silicon AF Transistor

- For AF input stages and driver applications
- High current gain
- Low collector-emitter saturation voltage
- Low noise between 30 Hz and 15 kHz
- Complementary types: BCW60, BCX70 (NPN)

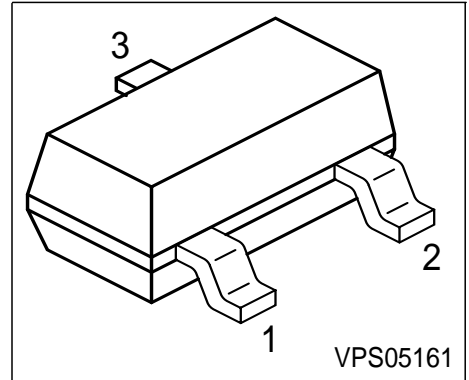

Type	Marking	Pin Configuration			Package
BCW 61A	BAs	1 = B	2 = E	3 = C	SOT23
BCW 61B	BBs	1 = B	2 = E	3 = C	SOT23
BCW 61C	BCs	1 = B	2 = E	3 = C	SOT23
BCW 61D	BDs	1 = B	2 = E	3 = C	SOT23
BCW 61FF	BFs	1 = B	2 = E	3 = C	SOT23
BCW 61FN	BNs	1 = B	2 = E	3 = C	SOT23
BCX 71G	BGs	1 = B	2 = E	3 = C	SOT23
BCX 71H	BHs	1 = B	2 = E	3 = C	SOT23
BCX 71J	BJs	1 = B	2 = E	3 = C	SOT23
BCX 71K	BKs	1 = B	2 = E	3 = C	SOT23

Maximum Ratings

Parameter	Symbol	BCW61	BCW61FF	BCX71	Unit
Collector-emitter voltage	V_{CEO}	32	32	45	V
Collector-base voltage	V_{CBO}	32	32	45	
Emitter-base voltage	V_{EBO}	5	5	5	
DC collector current	I_C	100			mA
Peak collector current	I_{CM}	200			mA
Peak base current	I_{BM}	200			
Total power dissipation, $T_S = 71\text{ °C}$	P_{tot}	330			mW
Junction temperature	T_j	150			°C
Storage temperature	T_{stg}	-65 ... 150			

Thermal Resistance

Junction - soldering point ¹⁾	R_{thJS}	≤240	K/W
--	------------	------	-----

Electrical Characteristics at $T_A = 25\text{ °C}$, unless otherwise specified.

Parameter	Symbol	Values			Unit
		min.	typ.	max.	

DC Characteristics

Collector-emitter breakdown voltage $I_C = 10\text{ mA}$, $I_B = 0$	$V_{(BR)CEO}$				V
BCW61/61FF		32	-	-	
BCX71		45	-	-	
Collector-base breakdown voltage $I_C = 10\text{ }\mu\text{A}$, $I_B = 0$	$V_{(BR)CBO}$				
BCW61/61FF		32	-	-	
BCX71		45	-	-	
Emitter-base breakdown voltage $I_E = 1\text{ }\mu\text{A}$, $I_C = 0$	$V_{(BR)EBO}$	5	-	-	

¹For calculation of R_{thJA} please refer to Application Note Thermal Resistance

Electrical Characteristics at $T_A = 25^\circ\text{C}$, unless otherwise specified.

Parameter	Symbol	Values			Unit
		min.	typ.	max.	
AC Characteristics					
Collector cutoff current $V_{CB} = 32\text{ V}, I_E = 0$ $V_{CB} = 45\text{ V}, I_E = 0$	I_{CBO}	-	-	20	nA
	BCW61/61FF	-	-	20	
	BCX71	-	-	20	
Collector cutoff current $V_{CB} = 32\text{ V}, I_E = 0, T_A = 150^\circ\text{C}$ $V_{CB} = 45\text{ V}, I_E = 0, T_A = 150^\circ\text{C}$	I_{CBO}	-	-	20	μA
	BCW61/61FF	-	-	20	
	BCX71	-	-	20	
Emitter cutoff current $V_{EB} = 4\text{ V}, I_C = 0$	I_{EBO}	-	-	20	nA
DC current gain 1) $I_C = 10\ \mu\text{A}, V_{CE} = 5\text{ V}$	h_{FE}	20	140	-	-
	h_{FE} -grp. A/G	30	200	-	
	h_{FE} -grp. B/H	40	300	-	
	h_{FE} -grp. C/J/FF	100	460	-	
	h_{FE} -grp. D/K/FN				
DC current gain 1) $I_C = 2\text{ mA}, V_{CE} = 5\text{ V}$	h_{FE}	120	170	220	
	h_{FE} -grp. A/G	180	250	310	
	h_{FE} -grp. B/H	250	350	460	
	h_{FE} -grp. C/J/FF	380	500	630	
	h_{FE} -grp. D/K/FN				
DC current gain 1) $I_C = 50\text{ mA}, V_{CE} = 1\text{ V}$	h_{FE}	60	-	-	
	h_{FE} -grp. A/G	80	-	-	
	h_{FE} -grp. B/H	100	-	-	
	h_{FE} -grp. C/J/FF	110	-	-	
	h_{FE} -grp. D/K/FN				

 1) Pulse test: $t \leq 300\ \mu\text{s}$, $D = 2\%$

Electrical Characteristics at $T_A = 25^\circ\text{C}$, unless otherwise specified.

Parameter	Symbol	Values			Unit
		min.	typ.	max.	
Characteristics					
Collector-emitter saturation voltage1) $I_C = 10\text{ mA}, I_B = 0.25\text{ mA}$ $I_C = 50\text{ mA}, I_B = 1.25\text{ mA}$	V_{CEsat}	-	0.12 0.2	0.25 0.55	V
Base-emitter saturation voltage 1) $I_C = 10\text{ mA}, I_B = 0.25\text{ mA}$ $I_C = 50\text{ mA}, I_B = 1.25\text{ mA}$	V_{BEsat}	-	0.7 0.83	0.85 1.05	
Base-emitter voltage 1) $I_C = 10\text{ }\mu\text{A}, V_{CE} = 5\text{ V}$ $I_C = 2\text{ mA}, V_{CE} = 5\text{ V}$ $I_C = 50\text{ mA}, V_{CE} = 1\text{ V}$	$V_{BE(ON)}$	- 0.55 -	0.52 0.65 0.78	- 0.75 -	
AC Characteristics					
Transition frequency $I_C = 20\text{ mA}, V_{CE} = 5\text{ V}, f = 100\text{ MHz}$	f_T	-	250	-	MHz
Collector-base capacitance $V_{CB} = 10\text{ V}, f = 1\text{ MHz}$	C_{cb}	-	3	-	pF
Emitter-base capacitance $V_{EB} = 0.5\text{ V}, f = 1\text{ MHz}$	C_{eb}	-	8	-	
Short-circuit input impedance $I_C = 2\text{ mA}, V_{CE} = 5\text{ V}, f = 1\text{ kHz}$	$h_{FE-grp.}$ A/G B/H C/J/FF D/K/FN	h_{11e}	- 2.7 3.6 4.5 7.5	- - - -	k Ω
Open-circuit reverse voltage transf.ratio $I_C = 2\text{ mA}, V_{CE} = 5\text{ V}, f = 1\text{ kHz}$	$h_{FE-grp.}$ A/G B/H C/J/FF D/K/FN	h_{12e}	- 1.5 2 2 3	- - - -	10^{-4}

 1) Pulse test: $t \leq 300\mu\text{s}$, $D = 2\%$

Electrical Characteristics at $T_A = 25^\circ\text{C}$, unless otherwise specified.

Parameter	Symbol	Values			Unit	
		min.	typ.	max.		
AC Characteristics						
Short-circuit forward current transf.ratio $I_C = 2 \text{ mA}$, $V_{CE} = 5 \text{ V}$, $f = 1 \text{ kHz}$	$h_{FE}\text{-grp.}$	h_{21e}				-
	A/G		-	200	-	
	B/H		-	260	-	
	C/J/FF		-	330	-	
	D/K/FN		-	520	-	
Open-circuit output admittance $I_C = 2 \text{ mA}$, $V_{CE} = 5 \text{ V}$, $f = 1 \text{ kHz}$	$h_{FE}\text{-grp.}$	h_{22e}				μS
	A/G		-	18	-	
	B/H		-	24	-	
	C/J/FF		-	30	-	
	D/K/FN		-	50	-	
Noise figure $I_C = 200 \mu\text{A}$, $V_{CE} = 5 \text{ V}$, $R_S = 1 \text{ k}\Omega$, $f = 1 \text{ kHz}$, $\Delta f = 200 \text{ Hz}$	$h_{FE}\text{-grp.}$	F				dB
	A/K		-	2	-	
	FF/FN		-	1	2	
Equivalent noise voltage $I_C = 200 \mu\text{A}$, $V_{CE} = 5 \text{ V}$, $R_S = 2 \text{ k}\Omega$, $f = 10 \dots 50 \text{ Hz}$	$h_{FE}\text{-grp.}$	V_n	-	-	0.11	μV
	FF/FN					

Total power dissipation $P_{tot} = f(T_S)$

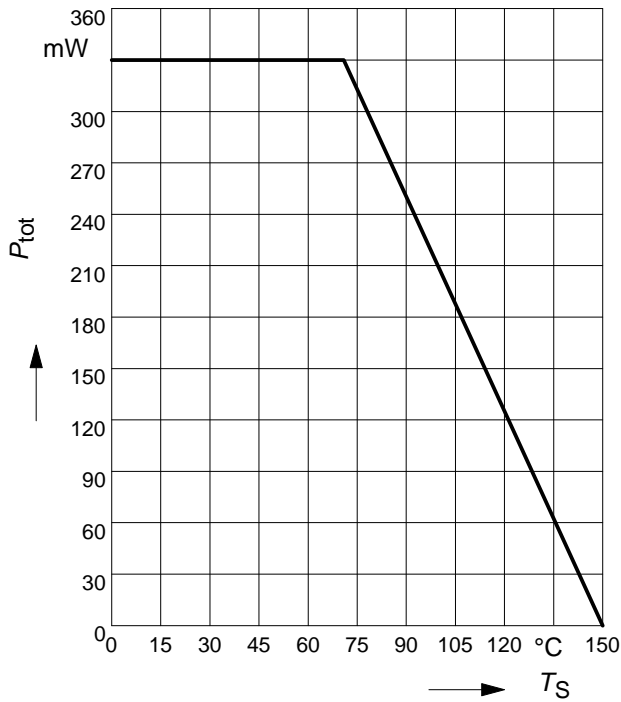

**Collector-base capacitance $C_{CB} = f(V_{CBO})$
Emitter-base capacitance $C_{EB} = f(V_{EBO})$**

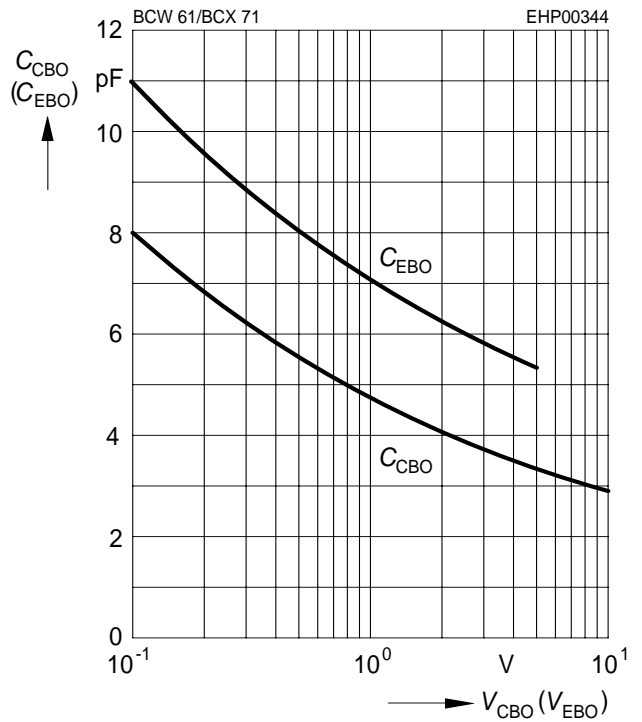

Permissible pulse load

$P_{totmax} / P_{totDC} = f(t_p)$

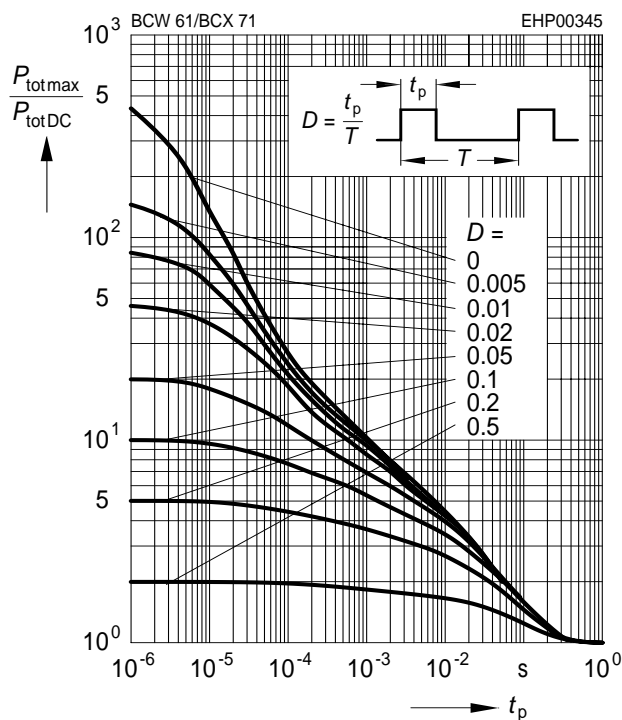

Transition frequency $f_T = f(I_C)$

$V_{CE} = 5V$

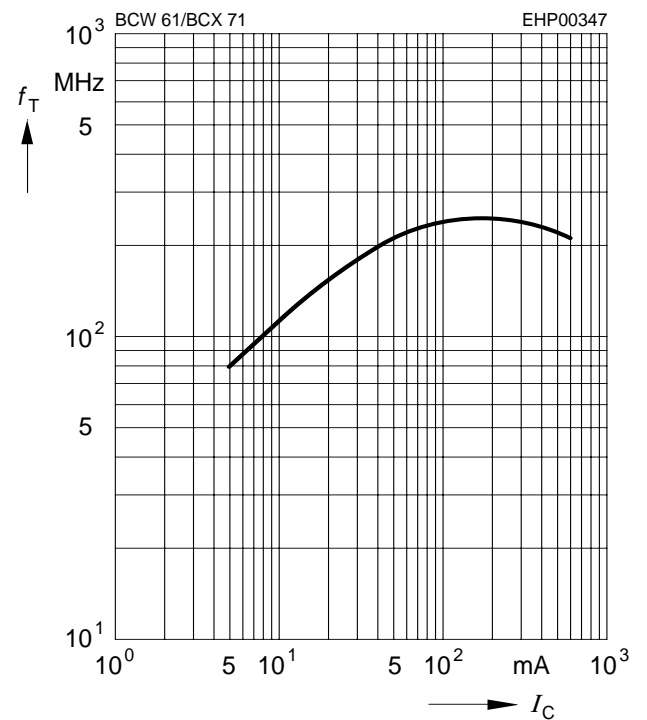

Base-emitter saturation voltage

$I_C = f(V_{BEsat}), h_{FE} = 40$

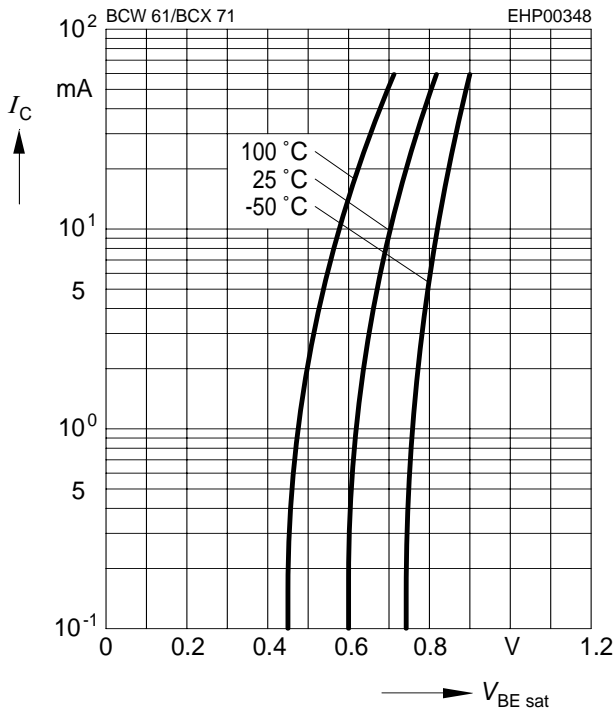

Collector-emitter saturation voltage

$I_C = f(V_{CEsat}), h_{FE} = 40$

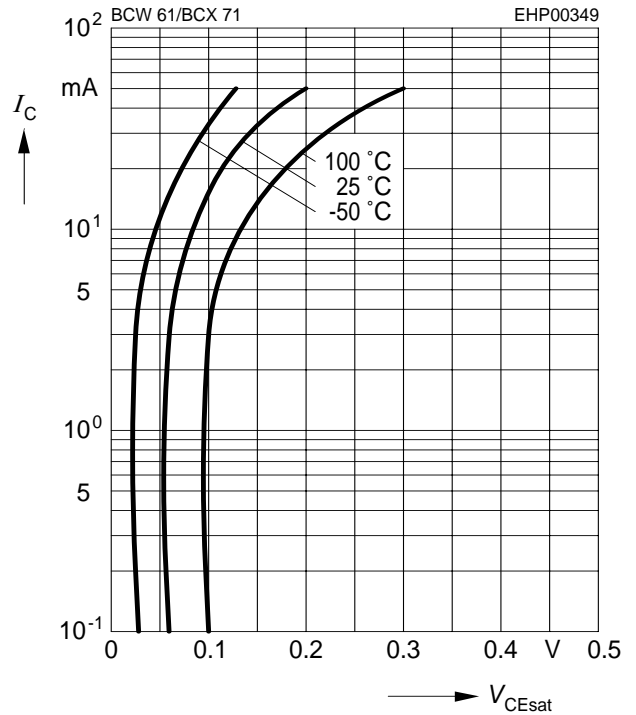

Collector current $I_C = f(V_{BE})$

$V_{CE} = 5V$

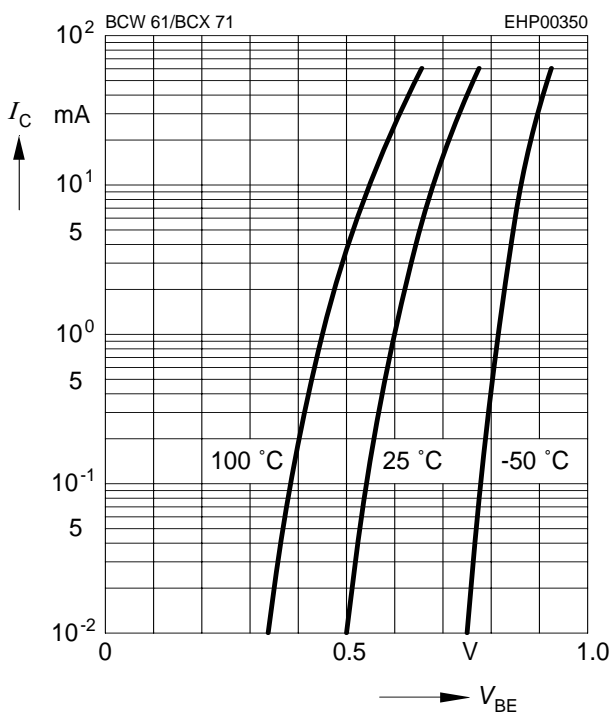

DC current gain $h_{FE} = f(I_C)$

$V_{CE} = 5V$

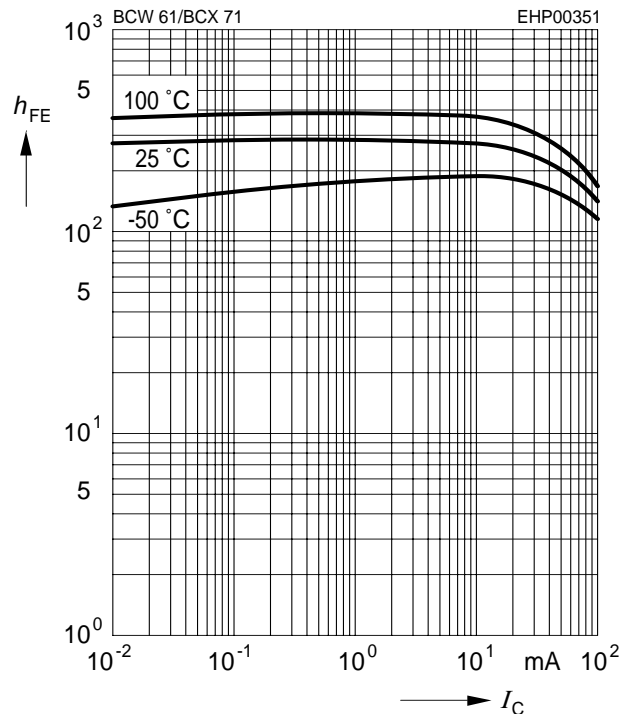

Collector cutoff current $I_{CBO} = f(T_A)$

$V_{CB} = V_{CEmax}$

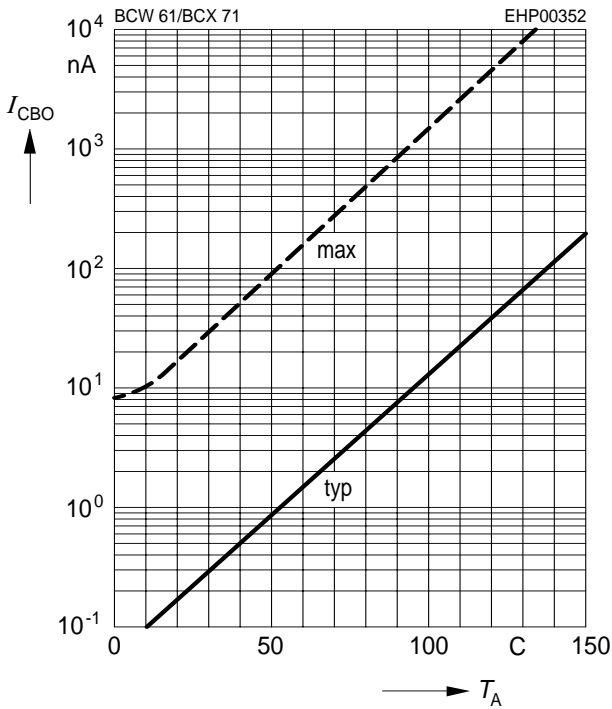

h parameter $h_e = f(I_C)$ normalized

$V_{CE} = 5V$

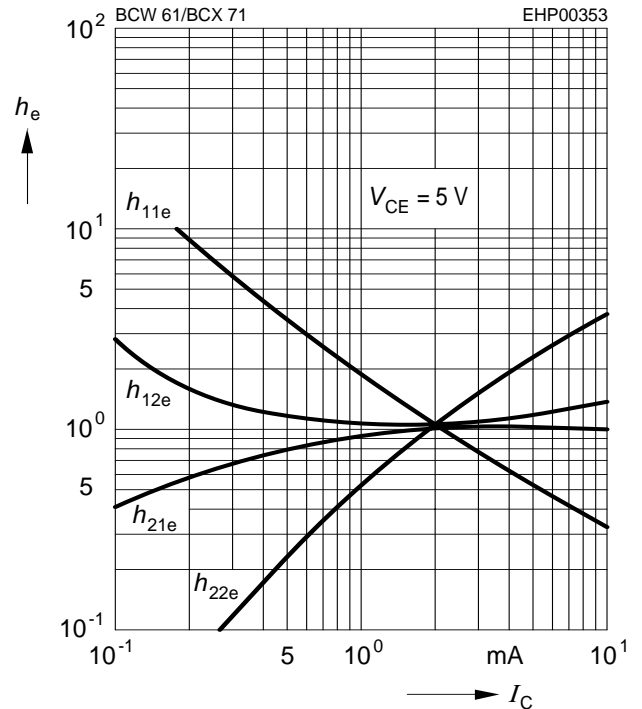

h parameter $h_e = f(V_{CE})$ normalized

$I_C = 2mA$

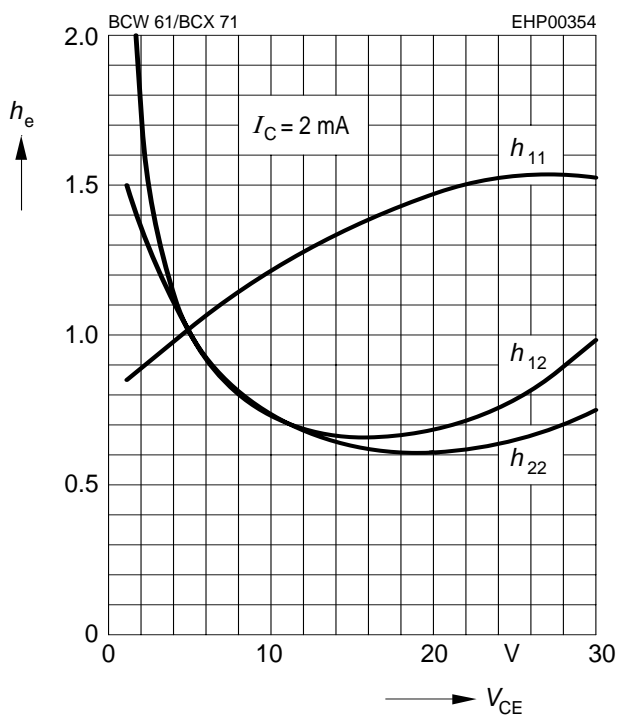

Noise figure $F = f(V_{CE})$

$I_C = 0.2mA, R_S = 2k\Omega, f = 1kHz$

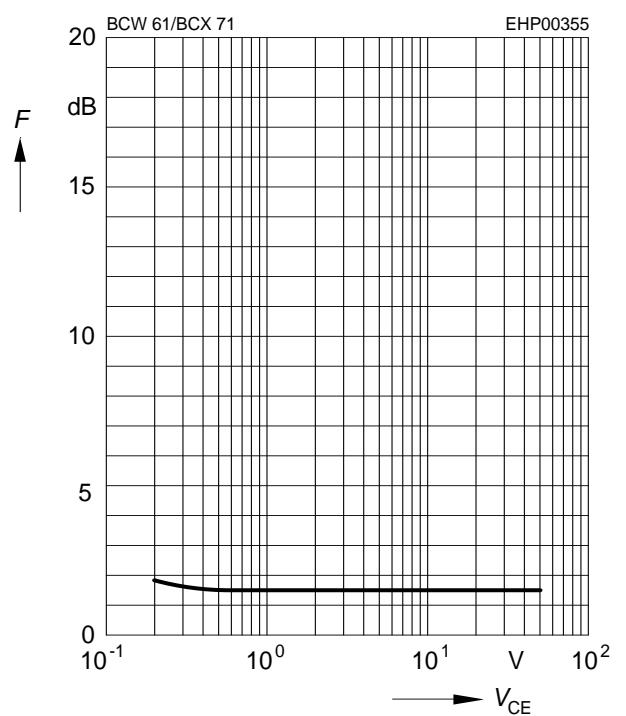

Noise figure $F = f(f)$

$I_C = 0.2\text{mA}$, $V_{CE} = 5\text{V}$, $R_S = 2\text{k}\Omega$

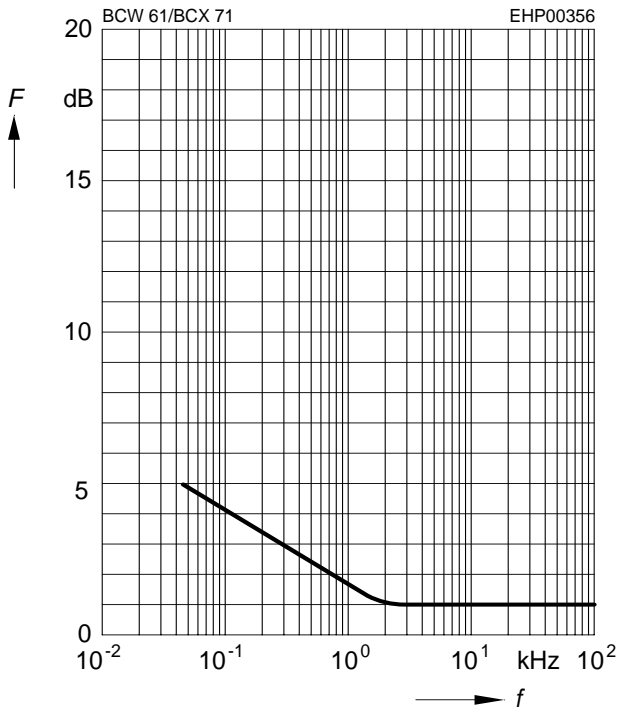

Noise figure $F = f(I_C)$

$V_{CE} = 5\text{V}$, $f = 120\text{Hz}$

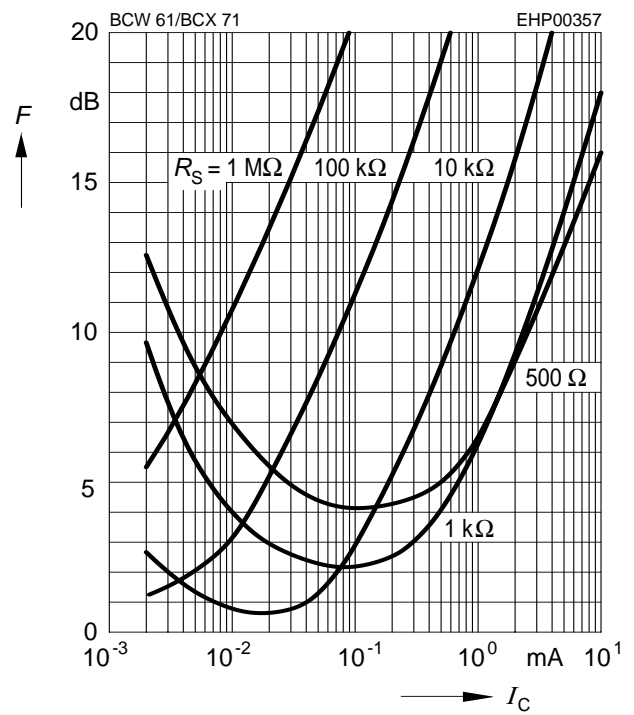

Noise figure $F = f(I_C)$

$V_{CE} = 5\text{V}$, $f = 1\text{kHz}$

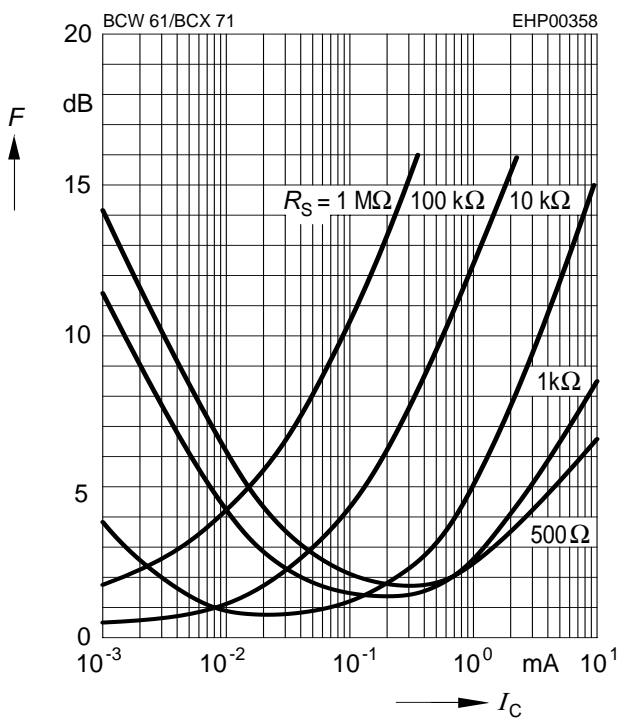

Noise figure $F = f(I_C)$

$V_{CE} = 5\text{V}$, $f = 10\text{kHz}$

