

BGA622

Silicon Germanium
Wide Band Low Noise Amplifier

Wireless
Silicon Discretes



Never stop thinking.

Edition 2002-12-18

**Published by Infineon Technologies AG,
St.-Martin-Strasse 53,
81669 München, Germany**

**© Infineon Technologies AG 2002.
All Rights Reserved.**

Attention please!

The information herein is given to describe certain components and shall not be considered as warranted characteristics.

Terms of delivery and rights to technical change reserved.

We hereby disclaim any and all warranties, including but not limited to warranties of non-infringement, regarding circuits, descriptions and charts stated herein.

Infineon Technologies is an approved CECC manufacturer.

Information

For further information on technology, delivery terms and conditions and prices please contact your nearest Infineon Technologies Office in Germany or our Infineon Technologies Representatives worldwide (see address list).

Warnings

Due to technical requirements components may contain dangerous substances. For information on the types in question please contact your nearest Infineon Technologies Office.

Infineon Technologies Components may only be used in life-support devices or systems with the express written approval of Infineon Technologies, if a failure of such components can reasonably be expected to cause the failure of that life-support device or system, or to affect the safety or effectiveness of that device or system. Life support devices or systems are intended to be implanted in the human body, or to support and/or maintain and sustain and/or protect human life. If they fail, it is reasonable to assume that the health of the user or other persons may be endangered.

BGA622**Data Sheet****Revision History: 2002-12-18**Previous Version: 2002-09-13

Page	Subjects (major changes since last revision)
5 - 6	Min. / max. limits for gain and noise figure added

For questions on technology, delivery and prices please contact the Infineon Technologies Offices in Germany or the Infineon Technologies Companies and Representatives worldwide: see our webpage at <http://www.infineon.com>

Silicon Germanium Wide Band Low Noise Amplifier

BGA622

Features

- High gain, $|S_{21}|^2=14.8$ dB at 1.575 GHz
 $|S_{21}|^2=13.9$ dB at 1.9 GHz
 $|S_{21}|^2=13.3$ dB at 2.14 GHz
 $|S_{21}|^2=12.7$ dB at 2.4 GHz
- Low noise figure, NF=1.1 dB at 2.14 GHz
- Operating frequency range 0.5 - 6 GHz
- Typical supply voltage: 2.75 V
- On/Off - Switch
- Output-match on chip, input pre-matched
- Low part count
- 70 GHz f_T - Silicon Germanium technology

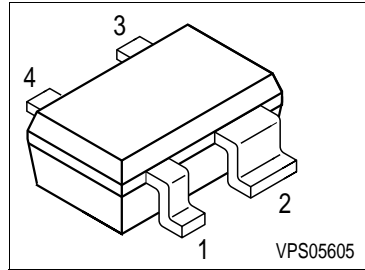

Applications

- LNA for GSM, GPS, DCS, PCS, UMTS, Bluetooth, ISM and WLAN

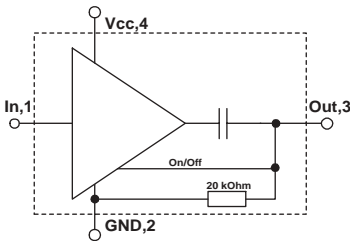

Description

The BGA622 is a wide band low noise amplifier, based on Infineon Technologies' Silicon Germanium Technology B7HF. In order to provide the LNA in a small package the out-pin is simultaneously used for RF out and On/Off switch. This functionality can be accessed using a RF-Choke at the Out pin, where a DC level of 0 V or an open switches the device on and a DC level of V_{cc} switches the device off. While the device is switched off, it provides an insertion loss of 20 dB together with a high IIP3 up to 18 dBm.

ESD: Electrostatic discharge sensitive device, observe handling precaution!

Type	Package	Marking	Chip
BGA622	SOT343	BRs	T0535

Maximum Ratings

Parameter	Symbol	Value	Unit
Voltage at pin Vcc	V_{CC}	3.5	V
Voltage at pin Out	V_{OUT}	4	V
Current into pin In	I_{IN}	0.1	mA
Current into pin Out	I_{OUT}	1	mA
Current into pin Vcc	I_{VCC}	10	mA
RF input power	P_{IN}	6	dBm
Total power dissipation, $T_S < 139\text{ °C}^{1)}$	P_{tot}	35	mW
Junction temperature	T_j	150	°C
Ambient temperature range	T_A	-65 ... +150	°C
Storage temperature range	T_{STG}	-65 ... +150	°C
Thermal resistance: junction-soldering point	R_{thJS}	300	K/W

¹⁾ T_S is measured on the ground lead at the soldering point

Note: All Voltages refer to GND-Node

Electrical Characteristics at $T_A=25\text{ °C}$ (measured according to fig. 1)
 $V_{CC}=2.75\text{ V}$, Frequency= 1.575 GHz , unless otherwise specified

Parameter	Symbol	min.	typ.	max.	Unit
Insertion power gain	$ S_{21} ^2$	12.7	14.8	16.7	dB
Insertion power gain (Off-State)	$ S_{21} ^2$		-24		dB
Input Return Loss (On-State)	RL_{IN}		6		dB
Output Return Loss (On-State)	RL_{OUT}		12		dB
Noise Figure ($Z_S=50\Omega$)	$F_{50\Omega}$		1.05	1.6	dB
Input Third Order Intercept Point ¹⁾ (On-State) $\Delta f=1\text{ MHz}$, $P_{IN}=-28\text{ dBm}$	IIP_3		0		dBm
Input Third Order Intercept Point ¹⁾ (Off-State) $\Delta f=1\text{ MHz}$, $P_{IN}=-8\text{ dBm}$	IIP_3		18		dBm
Input Power at 1dB Gain Compression	P_{-1dB}		-16.5		dBm
Total Device Off Current, $V_{CC}=2.75\text{ V}$, $V_{out}=V_{CC}$	$I_{tot-off}$		260		μA
Total Device On Current, $V_{CC}=2.75\text{ V}$	I_{tot-on}		5.8		mA

¹⁾ IIP_3 value depends on termination of all intermodulation frequency components. Termination used for this measurement is $50\ \Omega$ from 0.1 to 6 GHz

Electrical Characteristics at $T_A=25^{\circ}\text{C}$ (measured according to fig. 1)

$V_{CC}=2.75\text{ V}$, Frequency= 2.14 GHz , unless otherwise specified

Parameter	Symbol	min.	typ.	max.	Unit
Insertion power gain	$ S_{21} ^2$	11.4	13.3	15.0	dB
Insertion power gain (Off-State)	$ S_{21} ^2$		-20		dB
Input Return Loss (On-State)	RL_{IN}		8		dB
Output Return Loss (On-State)	RL_{OUT}		10		dB
Noise Figure ($Z_S=50\Omega$)	$F_{50\Omega}$		1.1	1.6	dB
Input Third Order Intercept Point ¹⁾ (On-State) $\Delta f=1\text{MHz}$, $P_{IN}=-28\text{dBm}$	IIP_3		3		dBm
Input Third Order Intercept Point ¹⁾ (Off-State) $\Delta f=1\text{MHz}$, $P_{IN}=-8\text{dBm}$	IIP_3		18		dBm
Input Power at 1dB Gain Compression	P_{-1dB}		-13		dBm

¹⁾ IP3 value depends on termination of all intermodulation frequency components. Termination used for this measurement is $50\ \Omega$ from 0.1 to 6 GHz

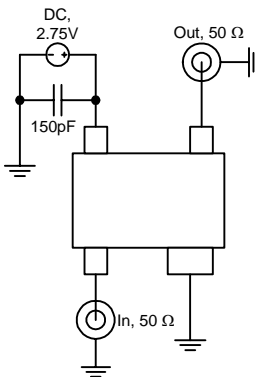

Figure 1 S-Parameter Test Circuit (loss-free microstrip test-fixture)

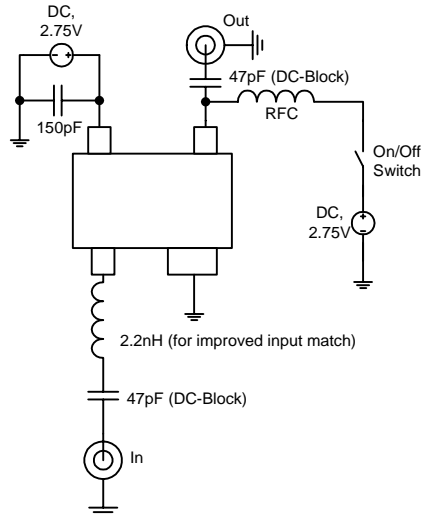
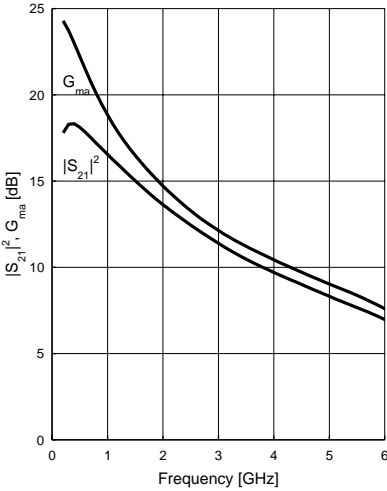

Figure 2 Application Circuit

Power Gain $|S_{21}|^2, G_{ma} = f(f)$

$V_{CC} = 2.75V, I_{tot-on} = 5.8mA$



Off Gain $|S_{21}|^2 = f(f)$

$V_{CC} = 2.75V, V_{OUT} = 2.75V, I_{tot-off} = 0.3mA$

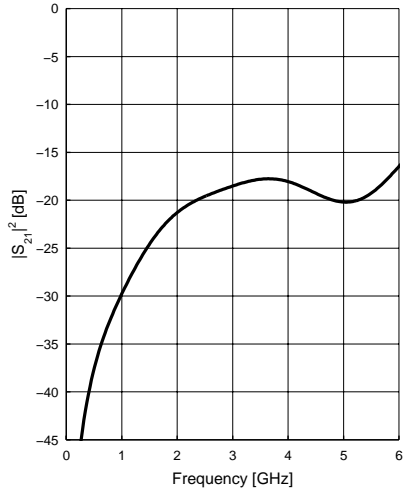

Reverse Isolation $|S_{12}| = f(f)$

$V_{CC} = 2.75V, I_{tot-on} = 5.8mA$

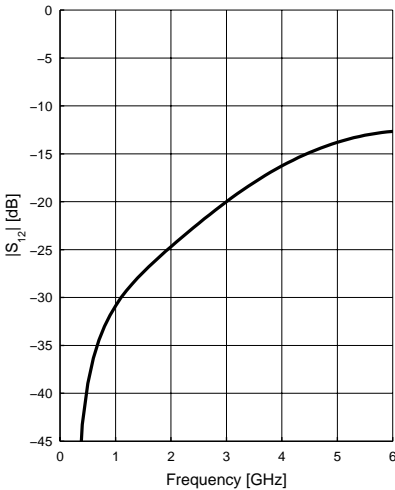

Matching $|S_{11}|, |S_{22}| = f(f)$

$V_{CC} = 2.75V, I_{tot-on} = 5.8mA$

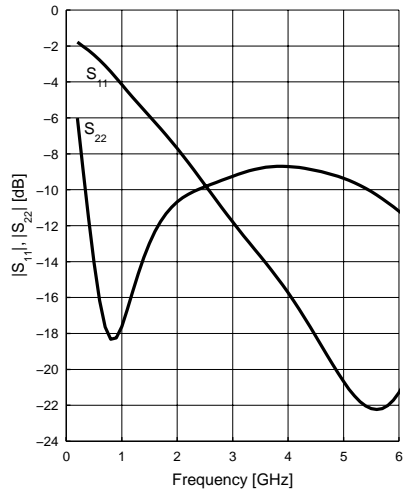

Stability K, B₁ = f(f)

V_{CC} = 2.75V, I_{tot-on} = 5.8mA

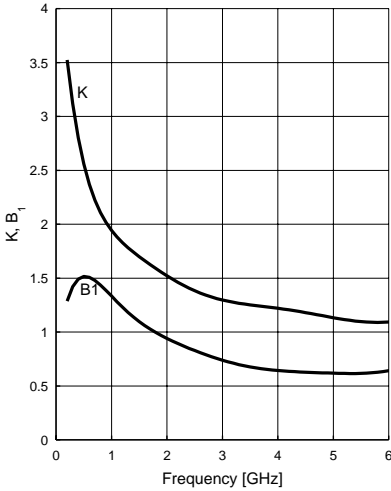

Noise Figure F = f(f)

V_{CC} = 2.75V, I_{tot-on} = 5.8mA, Z_S = 50Ω

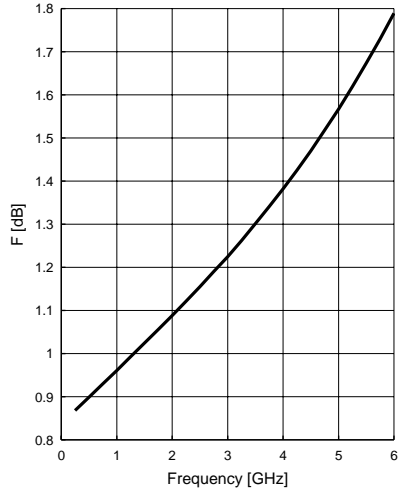

Input Compression Point P_{-1dB} = f(V_{CC})

f = 2.14GHz, T_A = -40 ... +85°C

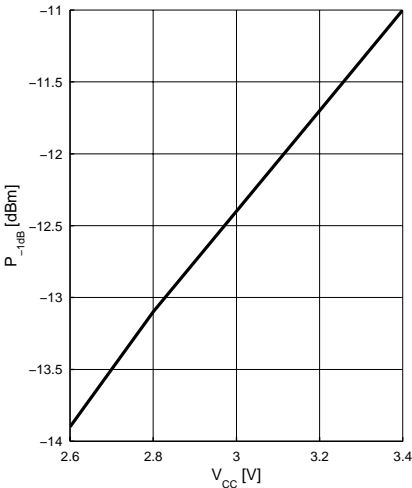

Device Current I_{tot-on} = f(T_A, V_{CC})

V_{CC} = parameter in V

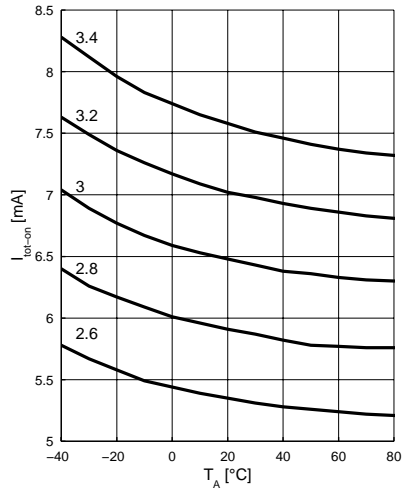

Device Current $I_{\text{tot-on}} = f(V_{\text{CC}}, T_A)$
 $T_A = \text{parameter in } ^\circ\text{C}$

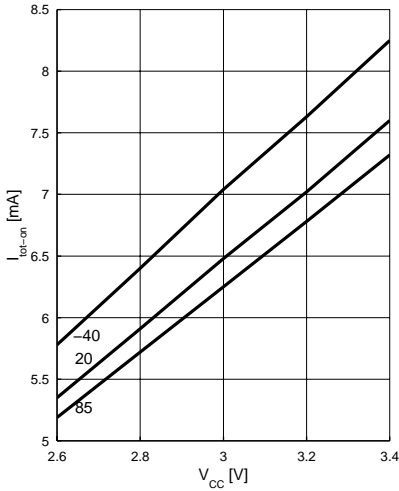

Power Gain $|S_{21}|^2 = f(T_A, V_{\text{CC}})$
 $f = 2.14\text{GHz}, V_{\text{CC}} = \text{parameter in V}$

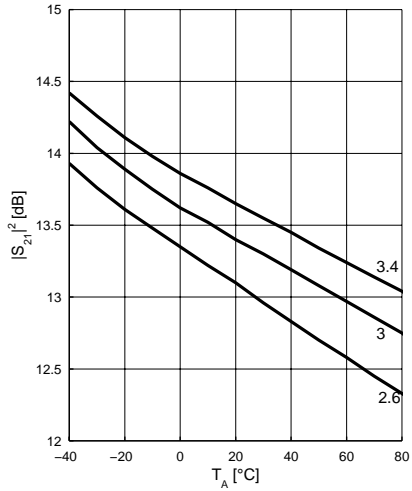

Power Gain $|S_{21}|^2 = f(V_{\text{CC}}, T_A)$
 $f = 2.14\text{GHz}, T_A = \text{parameter in } ^\circ\text{C}$

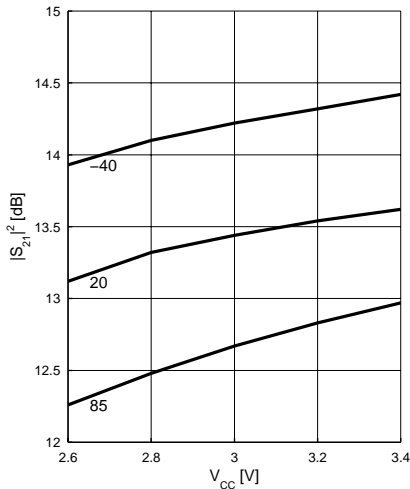

Package Outline

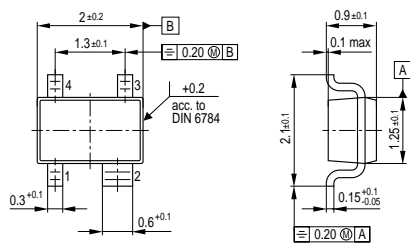

GPS06605