

BGB540 as a 1.85 GHz Low Noise Amplifier

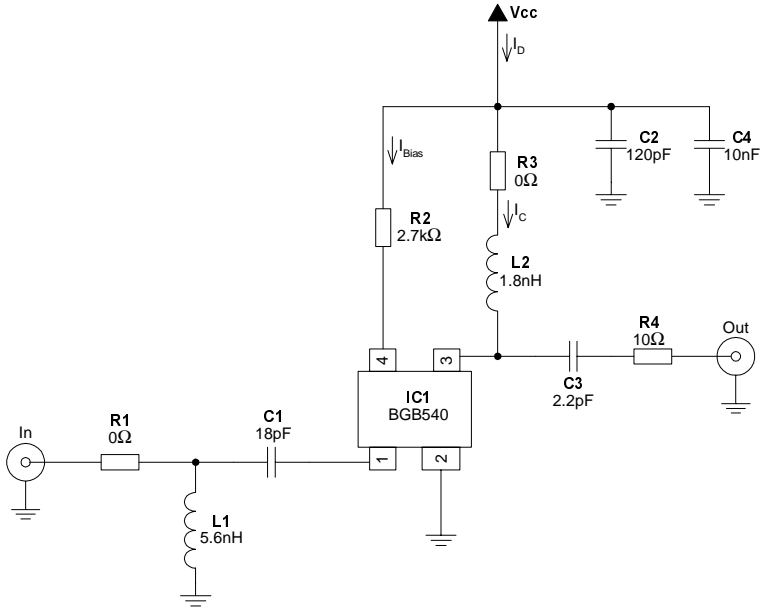

Figure 1 Application Circuit Diagram

Table 1 Measured Performance Data at 1850 MHz and $V_{CC} = 3$ V.

Parameter	Symbol	Value	Unit
Supply current	I_{CC}	7.8	mA
Insertion power gain	$ S_{21} ^2$	14.2	dB
Noise figure	NF	1.65	dB
Input return loss	$ S_{11} ^2$	10.3	dB
Output return loss	$ S_{22} ^2$	11.2	dB
Reverse isolation	$ S_{12} ^2$	22.8	dB
Input 1 dB-compression point	IP_{1dB}	-8.5	dBm
Input third order intercept point ¹⁾	IIP_3	0	dBm

¹⁾ $\Delta f = 1$ MHz; $P_{in} = -25$ dBm

Table 2 Bill of Materials

Name	Value	Package	Manufacturer	Function
C1	18 pF	0402	various	Input matching, DC block
C2	120 pF	0402	various	RF bypass
C3	2.2 pF	0402	various	Output matching, DC block
C4	10 nF	0402	various	RF bypass
IC1	BGB540	SOT343	Infineon Technologies	Active biased transistor
L1	5.6 nH	0402	Toko LL 1005-FH	Input matching
L2	1.8 nH	0402	Toko LL 1005-FH	Output matching, RF choke
R1	0 Ω	0402	various	Jumper
R2	2.7 k Ω	0402	various	Supply current adjustment
R3	0 Ω	0402	various	Jumper
R4	10 Ω	0402	various	Stabilization

Measured Circuit Performance

All presented measurement values include losses of both PCB and connectors - in other words, the reference planes used for measurements are the PCB's RF SMA connectors. Noise figure and gain results shown do not have any PCB loss extracted from them.

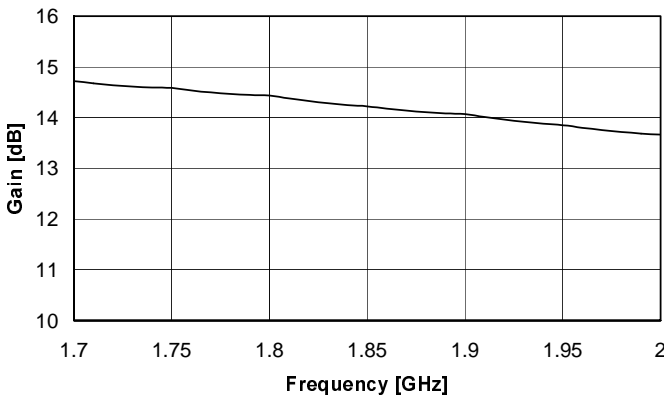

Figure 2 Insertion Gain

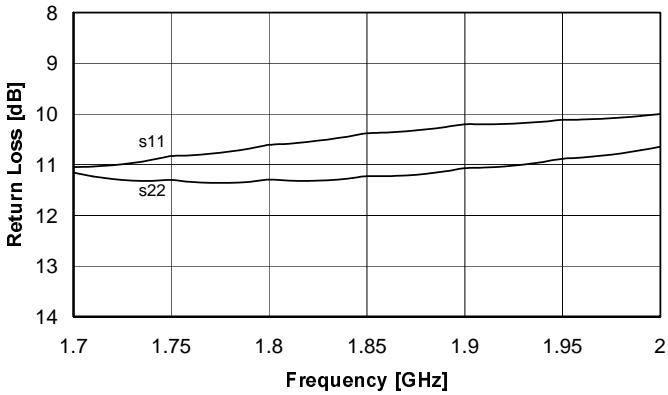

Figure 3 Input and Output Return Loss

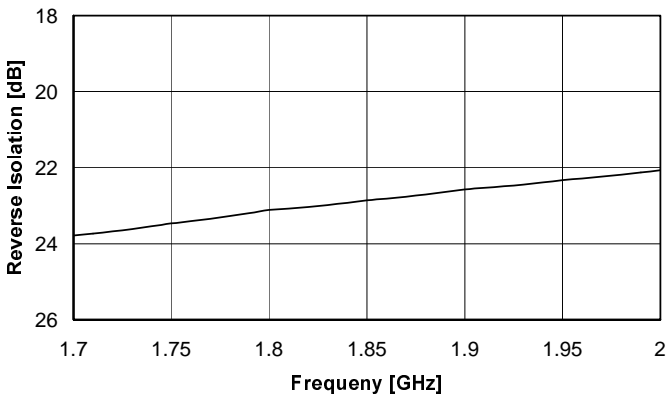

Figure 4 Reverse Isolation

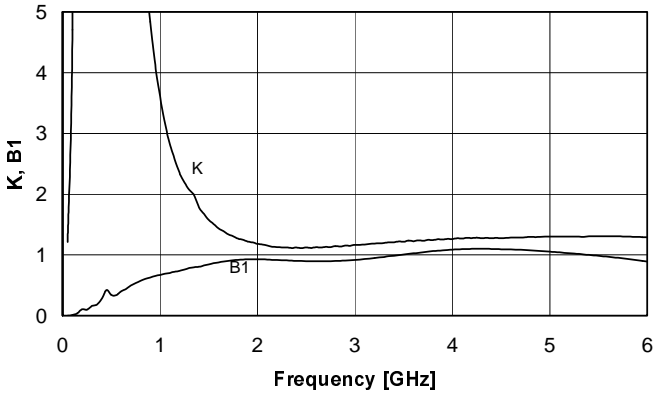

Figure 5 Stability Factor K and Stability Measure B1

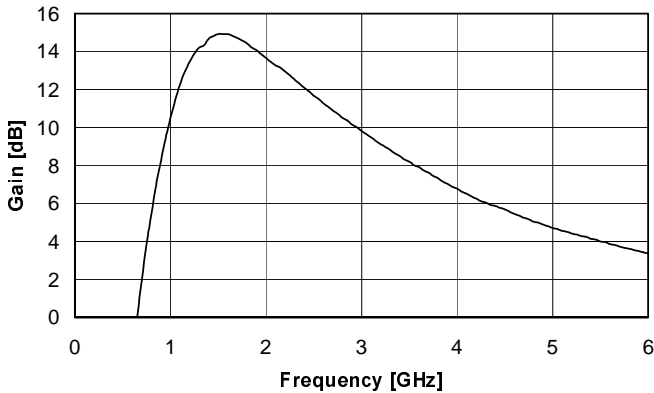

Figure 6 Wide Span Gain

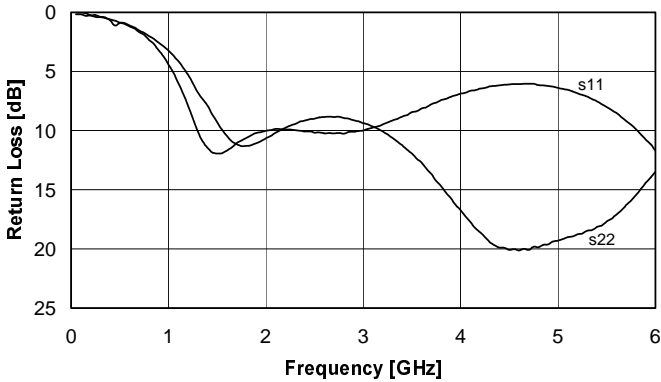

Figure 7 Wide Span Return Loss

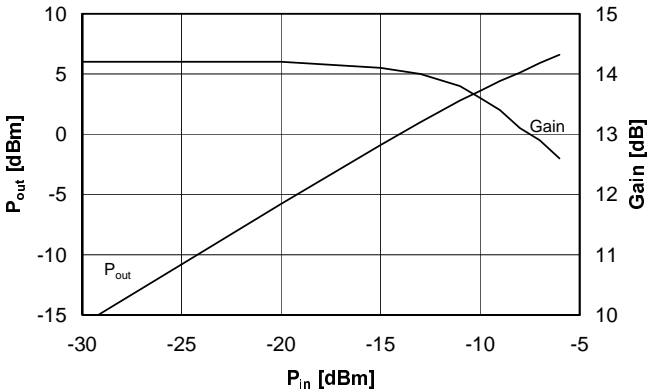

Figure 8 Gain Compression @ 1.85 GHz

Application board and component placement

Figure 9 shows the placement of the specific components on the application PCB.

Figure 10 displays the cross section of the application board. The actually used microstrip structure is the one with the 0.2 mm FR4 dielectric. The 0.8 mm FR4 are for mechanical rigidity purposes only.

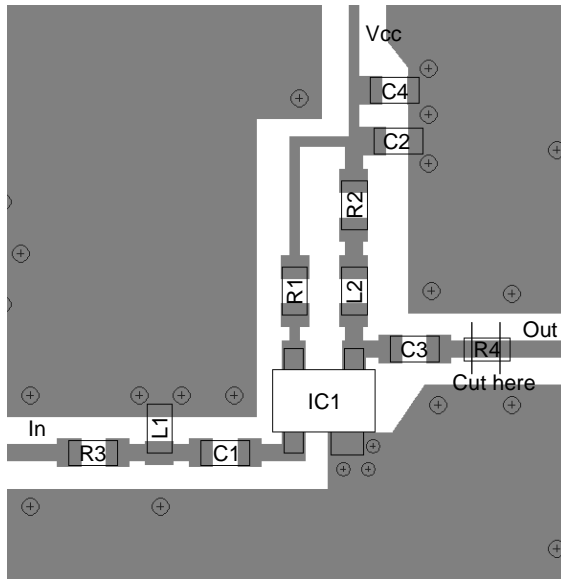

Figure 9 Component Placement on the Application PCB

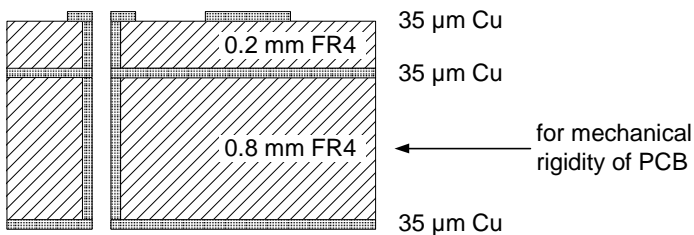

Figure 10 PCB Cross Section