

5 mm (T1 3/4) LED, Diffused Wide-Angle LED

LR 5480, LS 5480, LY 5480, LG 5480



Besondere Merkmale

- **Gehäusotyp:** eingefärbtes, diffuses 5 mm (T1 3/4) Gehäuse
- **Besonderheit des Bauteils:** Lötspieße ohne Aufsetzebene
- **Wellenlänge:** 645 nm (rot), 628 nm (super-rot), 587 nm (gelb), 570 nm (grün)
- **Abstrahlwinkel:** 80°
- **Technologie:** GaAIP
- optischer Wirkungsgrad: 0,4 lm/W (rot), 1,5 lm/W (super-rot, gelb), 2,5 lm/W (grün)
- **Gruppierungsparameter:** Lichtstärke
- **Lötmethode:** Wellenlöten (TTW)
- **Verpackung:** Schüttgut, gegurtet lieferbar

Anwendungen

- optischer Indikator
- Hinterleuchtung (LCD, Handy, Schalter, Tasten, Displays, Werbebeleuchtung, Allgemeinbeleuchtung)
- Innenbeleuchtung im Automobilbereich (z.B. Instrumentenbeleuchtung, u.ä.)
- Markierungsbeleuchtung (z.B. Stufen, Fluchtwege, u.ä.)

Features

- **package:** colored, diffused 5 mm (T1 3/4) package
- **feature of the device:** solder leads without stand-off
- **wavelength:** 645 nm (red), 628 nm (super-red), 587 nm (yellow), 570 nm (green)
- **viewing angle:** 80°
- **technology:** GaAIP
- **optical efficiency:** 0.4 lm/W (red), 1.5 lm/W (super-red, yellow), 2.5 lm/W (green)
- **grouping parameter:** luminous intensity
- **soldering methods:** TTW soldering
- **packing:** bulk, available taped on reel

Applications

- optical indicators
- backlighting (LCD, cellular phones, switches, keys, displays, illuminated advertising, general lighting)
- interior automotive lighting (e.g. dashboard backlighting, etc.)
- marker lights (e.g. steps, exit ways, etc.)

Typ Type	Emissions- farbe Color of Emission	Gehäuse- farbe Color of Package	Lichtstärke Luminous Intensity $I_F = 10 \text{ mA}$ $I_V \text{ (mcd)}$	Lichtstrom Luminous Flux $I_F = 10 \text{ mA}$ $\Phi_V \text{ (lm)}$	Bestellnummer Ordering Code
LR 5480-CF LR 5480-E LR 5480-F LR 5480-DG	red	red diffused	0.28 ... 1.80 0.71 ... 1.12 1.12 ... 1.80 0.45 ... 2.80	4 (typ.) 3 (typ.) 5 (typ.) 6 (typ.)	Q62703-Q1986 Q62703-Q1734 Q62703-Q1987 Q62703-Q1408
LS 5480-GL LS 5480-J LS 5480-K LS 5480-L LS 5480-JM	super-red	red diffused	1.80 ... 18.00 4.50 ... 7.10 7.10 ... 11.20 11.20 ... 18.00 4.50 ... 28.00	35 (typ.) 20 (typ.) 30 (typ.) 50 (typ.) 60 (typ.)	Q62703-Q1989 Q62703-Q1414 Q62703-Q1990 Q62703-Q1991 Q62703-Q1992
LY 5480-HL LY 5480-J LY 5480-K LY 5480-L LY 5480-JM	yellow	yellow diffused	2.80 ... 18.00 4.50 ... 7.10 7.10 ... 11.20 11.20 ... 18.00 4.50 ... 28.00	35 (typ.) 20 (typ.) 30 (typ.) 50 (typ.) 60 (typ.)	Q62703-Q1416 Q62703-Q3236 Q62703-Q1418 Q62703-Q2402 Q62703-Q1419
LG 5480-GK LG 5480-H LG 5480-J LG 5480-K LG 5480-HL	green	green diffused	1.80 ... 11.20 2.80 ... 4.50 4.50 ... 7.10 7.10 ... 11.20 2.80 ... 18.00	20 (typ.) 12 (typ.) 20 (typ.) 30 (typ.) 50 (typ.)	Q62703-Q1423 Q62703-Q1422 Q62703-Q1869 Q62703-Q2018 Q62703-Q3191

Helligkeitswerte werden mit einer Stromeinprägedauer von 25 ms und einer Genauigkeit von $\pm 11 \%$ ermittelt.
Luminous intensity is tested at a current pulse duration of 25 ms and a tolerance of $\pm 11 \%$.

Anm.: Die Standardlieferform von Serientypen beinhaltet eine untere bzw. eine obere Familiengruppe oder mindestens zwei Einzelgruppen.

In einer Verpackungseinheit / Gurt ist immer nur eine Helligkeitsgruppe enthalten.

Die technologiebedingte Helligkeits-Streuung der heutigen LED-Herstellprozesse über einen längeren Fertigungszeitraum (Halbleitermaterial - Chipherstellung - Montageprozess) erlaubt keine Zusage einer einzelnen Helligkeitsgruppe. Daher müssen mindestens zwei Helligkeitsgruppen vorgesehen werden!

Note: The standard shipping format for serial types includes a lower or upper family group or at least two individual groups.

No packing unit / tape ever contains more than one luminous intensity group.

Luminosity variations caused by the technology used in current LED manufacturing processes over a protracted manufacturing period (semiconductor material - chip fabrication - assembly process) mean that it is not possible to assign LEDs to a single luminous intensity group. For this reason at least two luminous intensity groups must be provided!

Grenzwerte
Maximum Ratings

Bezeichnung Parameter	Symbol Symbol	Wert Value		Einheit Unit
		LR	LS, LY, LG	
Betriebstemperatur Operating temperature range	T_{op}	- 55 ... + 100		°C
Lagertemperatur Storage temperature range	T_{stg}	- 55 ... + 100		°C
Sperrschichttemperatur Junction temperature	T_j	+ 100		°C
Durchlassstrom Forward current	I_F	45	40	mA
Stoßstrom Surge current $t \leq 10 \mu s, D = 0.005$	I_{FM}	0.5		A
Sperrspannung Reverse voltage	V_R	5		V
Leistungsaufnahme Power consumption $T_A \leq 25 \text{ °C}$	P_{tot}	95	130	mW
Wärmewiderstand ¹⁾ Thermal resistance Sperrschicht/Umgebung Junction/ambient	$R_{th JA}$	400		K/W
Sperrschicht/Löt看 Junction/solder point Montage auf PC-Board FR 4 (Padgröße $\geq 16 \text{ mm}^2$) mounted on PC board FR 4 (pad size $\geq 16 \text{ mm}^2$) Minimale Beinchenlänge Minimum lead length	$R_{th JS}$	180		K/W

¹⁾ R_{th} erhöht sich um 13 K/W pro mm Beinchenlänge.
Each additional 1 mm of lead length increases R_{th} by 13 K/W.

Kennwerte ($T_A = 25\text{ °C}$)
Characteristics

Bezeichnung Parameter	Symbol Symbol	Wert Value				Einheit Unit
		LR	LS	LY	LG	
Wellenlänge des emittierten Lichtes (typ.) Wavelength at peak emission $I_F = 10\text{ mA}$	λ_{peak}	660	635	586	572	nm
Dominantwellenlänge ¹⁾ (typ.) Dominant wavelength $I_F = 10\text{ mA}$	λ_{dom}	645	628	587	570	nm
Spektrale Bandbreite bei 50 % $I_{\text{rel max}}$ (typ.) Spectral bandwidth at 50 % $I_{\text{rel max}}$ $I_F = 10\text{ mA}$	$\Delta\lambda$	35	45	45	25	nm
Abstrahlwinkel bei 50 % I_V (Vollwinkel) (typ.) Viewing angle at 50 % I_V	2ϕ	80	80	80	80	Grad deg.
Durchlassspannung ²⁾ (typ.) Forward voltage $I_F = 10\text{ mA}$	V_F V_F	1.6 1.9	2.0 2.5	2.0 2.5	2.0 2.5	V V
Sperrstrom (typ.) Reverse current $V_R = 5\text{ V}$	I_R I_R	0.01 10	0.01 10	0.01 10	0.01 10	μA μA
Temperaturkoeffizient von λ_{peak} (typ.) Temperature coefficient of λ_{peak} $I_F = 10\text{ mA}; -10\text{ °C} \leq T \leq 100\text{ °C}$	$TC_{\lambda_{\text{peak}}}$	0.03	0.11	0.10	0.11	nm/K
Temperaturkoeffizient von λ_{dom} (typ.) Temperature coefficient of λ_{dom} $I_F = 10\text{ mA}; -10\text{ °C} \leq T \leq 100\text{ °C}$	$TC_{\lambda_{\text{dom}}}$	0.06	0.07	0.07	0.07	nm/K
Temperaturkoeffizient von V_F (typ.) Temperature coefficient of V_F $I_F = 10\text{ mA}; -10\text{ °C} \leq T \leq 100\text{ °C}$	TC_V	- 1.4	- 1.9	- 1.9	- 1.4	mV/K
Optischer Wirkungsgrad (typ.) Optical efficiency $I_F = 10\text{ mA}$	η_{opt}	0.4	1.5	1.5	2.5	lm/W

¹⁾ Wellenlängen werden mit einer Stromeinprägedauer von 25 ms und einer Genauigkeit von $\pm 1\text{ nm}$ ermittelt.
Wavelengths are tested at a current pulse duration of 25 ms and a tolerance of $\pm 1\text{ nm}$.

²⁾ Spannungswerte werden mit einer Stromeinprägedauer von 1 ms und einer Genauigkeit von $\pm 0,1\text{ V}$ ermittelt.
Voltages are tested at a current pulse duration of 1 ms and a tolerance of $\pm 0.1\text{ V}$.

Relative spektrale Emission $I_{rel} = f(\lambda)$, $T_A = 25\text{ °C}$, $I_F = 10\text{ mA}$

Relative Spectral Emission

$V(\lambda)$ = spektrale Augenempfindlichkeit

Standard eye response curve

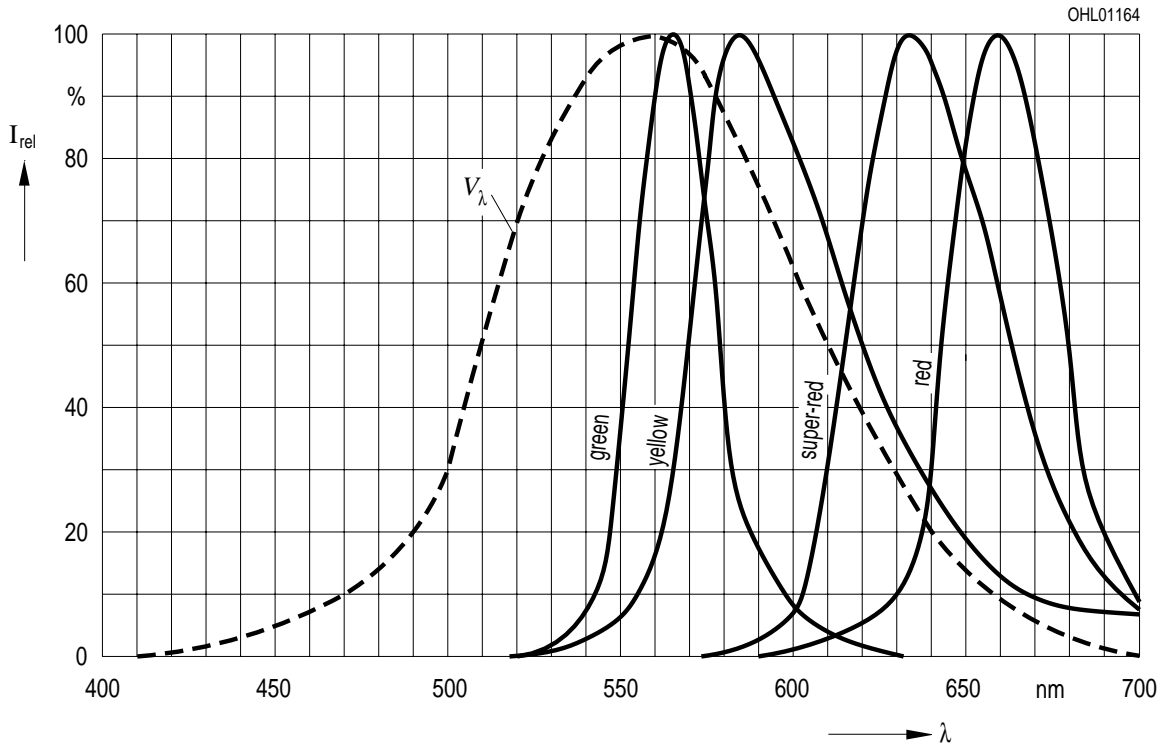

Abstrahlcharakteristik $I_{rel} = f(\varphi)$

Radiation Characteristic

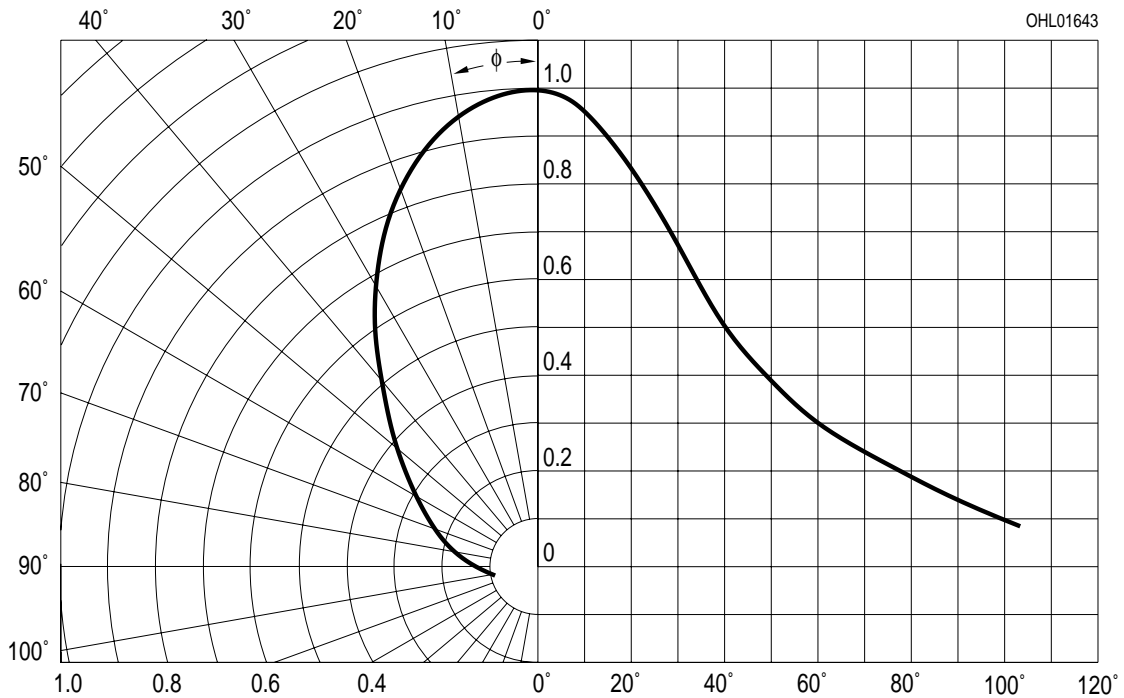

Durchlassstrom $I_F = f(V_F)$
Forward Current

$T_A = 25\text{ }^\circ\text{C}$

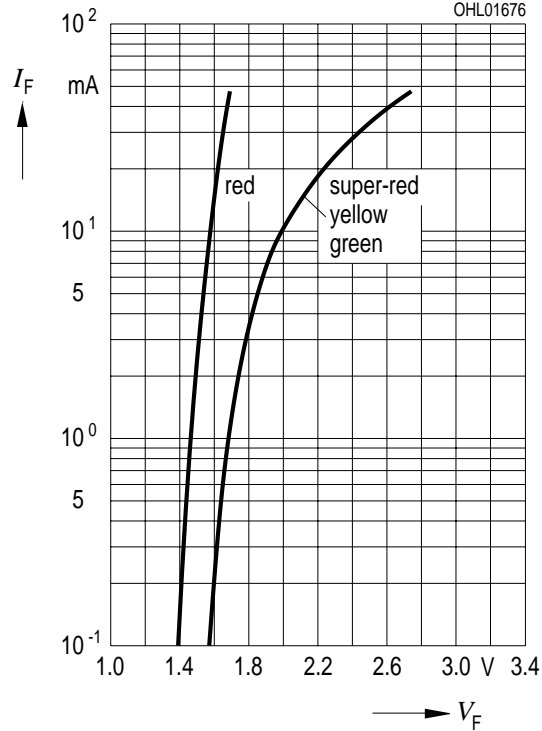

Relative Lichtstärke $I_V/I_{V(10\text{ mA})} = f(I_F)$
Relative Luminous Intensity

$T_A = 25\text{ }^\circ\text{C}$

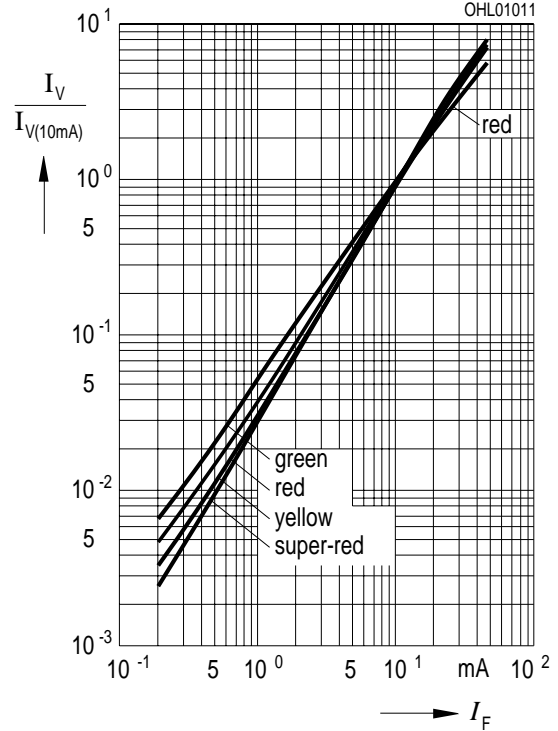

Maximal zulässiger Durchlassstrom $I_F = f(T)$
Max. Permissible Forward Current
LS, LY, LG

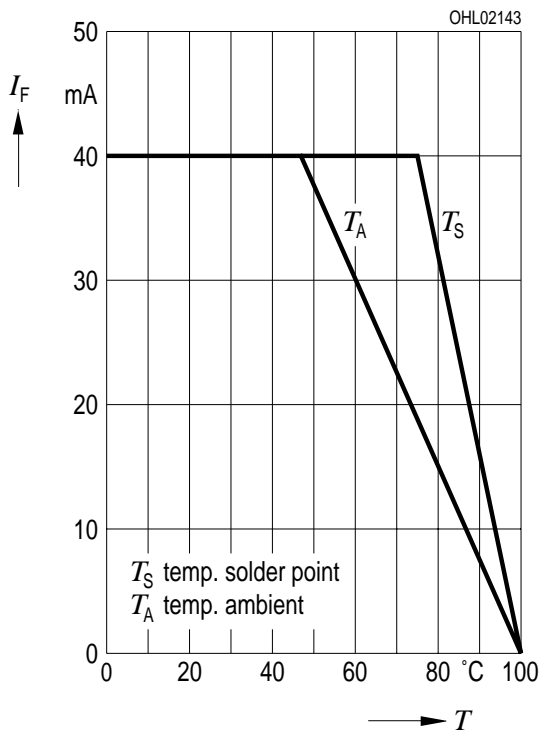

Maximal zulässiger Durchlassstrom $I_F = f(T)$
Max. Permissible Forward Current
LR

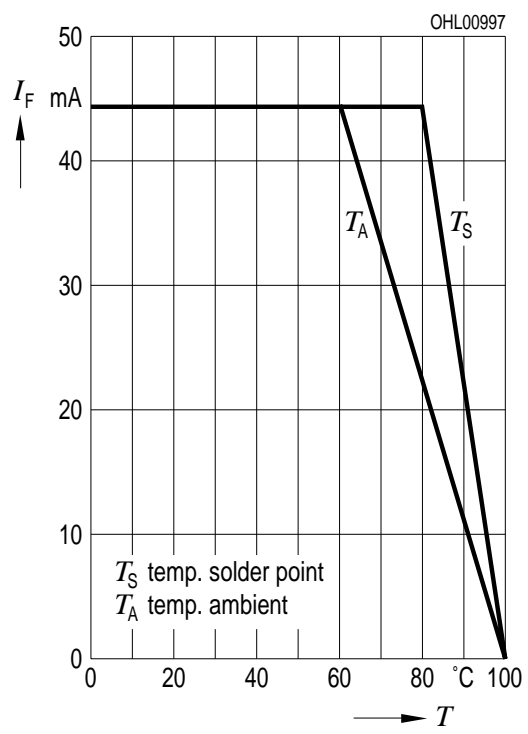

Relative Lichtstärke $I_V/I_{V(25\text{ °C})} = f(T_A)$
Relative Luminous Intensity

$I_F = 10\text{ mA}$

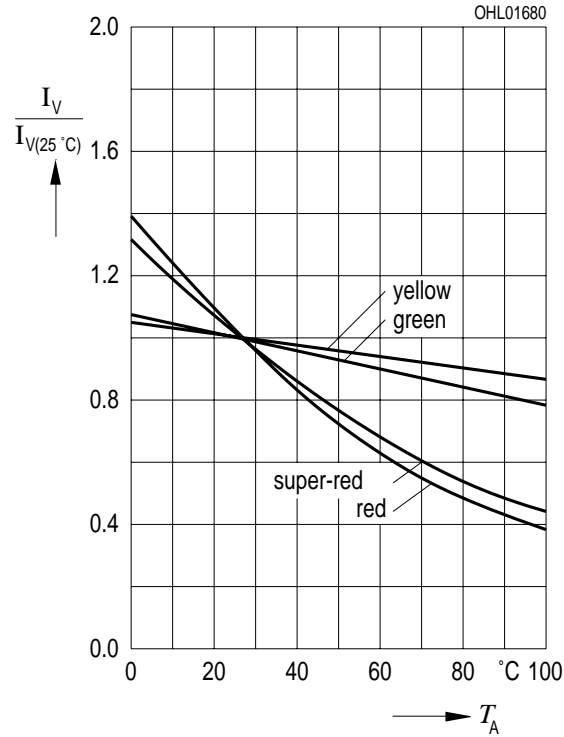

Zulässige Impulsbelastbarkeit $I_F = f(t_p)$
Permissible Pulse Handling Capability

Duty cycle $D = \text{parameter}$, $T_A = 25\text{ °C}$

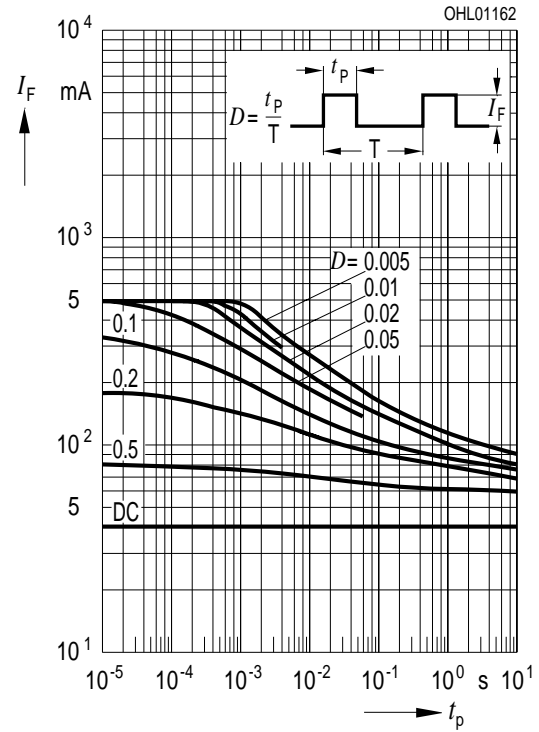

Lötbedingungen
Soldering Conditions

Wellenlöten (TTW) (nach CECC 00802)
TTW Soldering (acc. to CECC 00802)

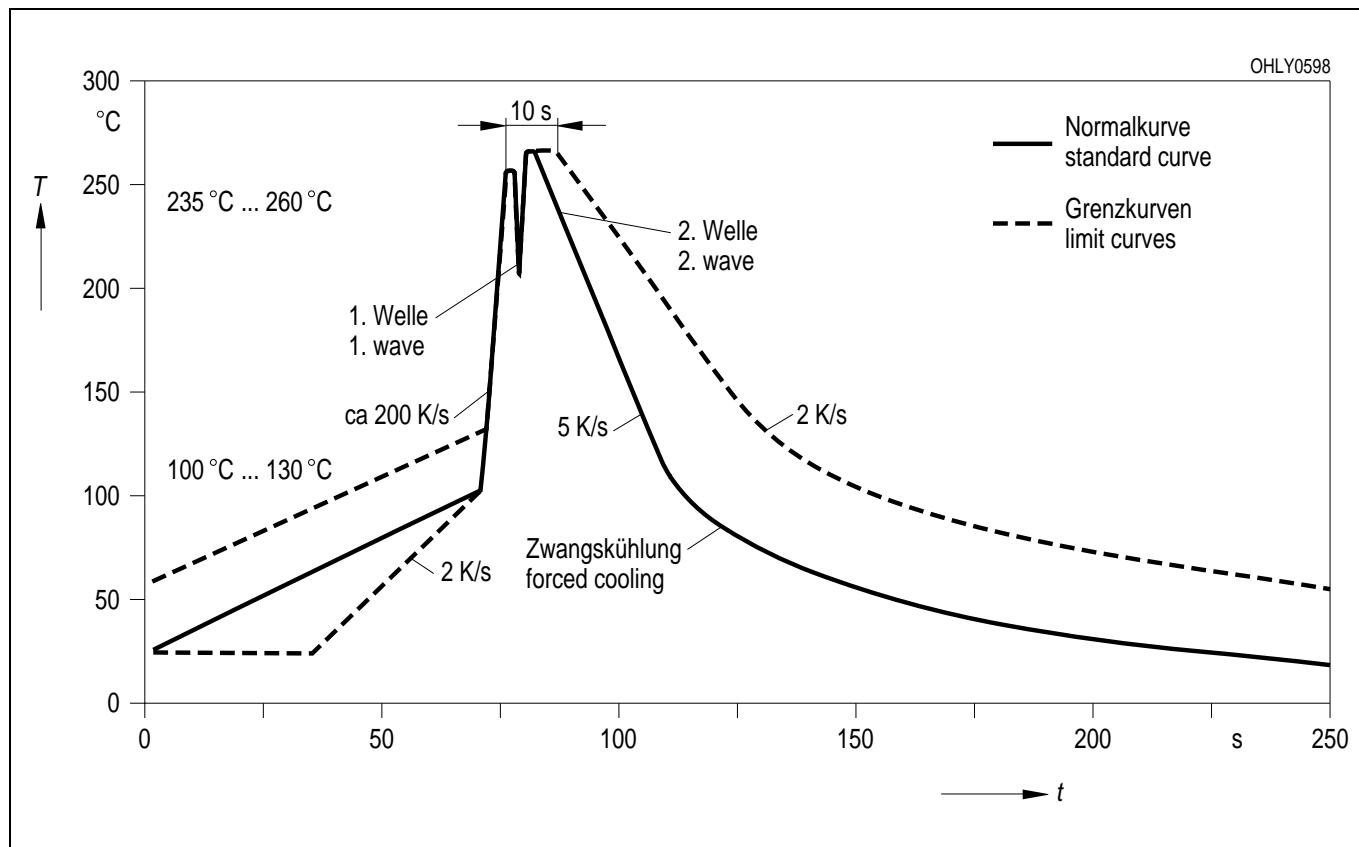

Empfohlenes Lötpaddesign Wellenlöten (TTW)
Recommended Solder Pad TTW Soldering

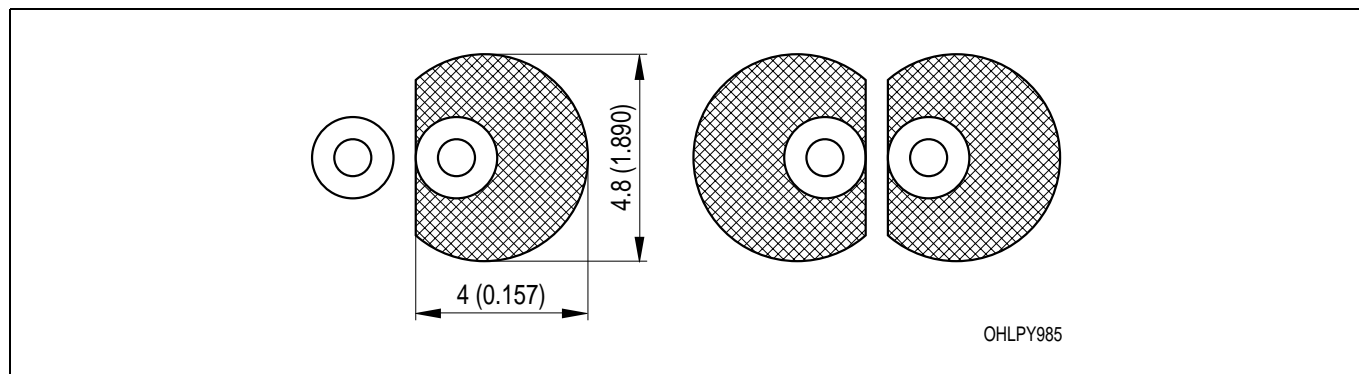

Maße werden wie folgt angegeben: mm (inch) / Dimensions are specified as follows: mm (inch).

Revision History: 2001-03-12

Previous Version: 2001-03-12

Page	Subjects (major changes since last revision)
3	thermal resistance (footnote)

Published by OSRAM Opto Semiconductors GmbH & Co. OHG

Wernerwerkstrasse 2, D-93049 Regensburg

© All Rights Reserved.

Attention please!

The information describes the type of component and shall not be considered as assured characteristics. Terms of delivery and rights to change design reserved. Due to technical requirements components may contain dangerous substances. For information on the types in question please contact our Sales Organization. If printed or downloaded, please find the latest version in the Internet.

Packing

Please use the recycling operators known to you. We can also help you – get in touch with your nearest sales office. By agreement we will take packing material back, if it is sorted. You must bear the costs of transport. For packing material that is returned to us unsorted or which we are not obliged to accept, we shall have to invoice you for any costs incurred.

Components used in life-support devices or systems must be expressly authorized for such purpose! Critical components ¹ may only be used in life-support devices or systems ² with the express written approval of OSRAM OS.

¹ A critical component is a component used in a life-support device or system whose failure can reasonably be expected to cause the failure of that life-support device or system, or to affect its safety or the effectiveness of that device or system.

² Life support devices or systems are intended (a) to be implanted in the human body, or (b) to support and/or maintain and sustain human life. If they fail, it is reasonable to assume that the health of the user may be endangered.