

PNP Silicon Switching Transistor

- High DC current gain: 0.1 mA to 100 mA
- Low collector-emitter saturation voltage
- Complementary type:
SMBT3904/ MMBT3904 (NPN)

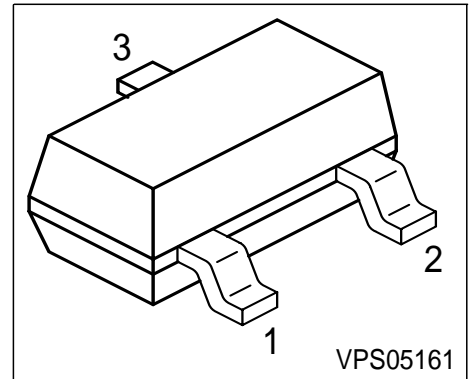

Type	Marking	Pin Configuration			Package
SMBT3906/ MMBT3906	s2A	1 = B	2 = E	3 = C	SOT23

Maximum Ratings

Parameter	Symbol	Value	Unit
Collector-emitter voltage	V_{CEO}	40	V
Collector-base voltage	V_{CBO}	40	
Emitter-base voltage	V_{EBO}	5	
Collector current	I_C	200	mA
Total power dissipation- $T_S = 71\text{ °C}$	P_{tot}	330	mW
Junction temperature	T_j	150	°C
Storage temperature	T_{stg}	-65 ... 150	

Thermal Resistance

Parameter	Symbol	Value	Unit
Junction - soldering point ¹⁾	R_{thJS}	≤240	K/W

¹⁾For calculation of R_{thJA} please refer to Application Note Thermal Resistance

Electrical Characteristics at $T_A = 25^\circ\text{C}$, unless otherwise specified

Parameter	Symbol	Values			Unit
		min.	typ.	max.	
DC Characteristics					
Collector-emitter breakdown voltage $I_C = 1 \text{ mA}, I_B = 0$	$V_{(BR)CEO}$	40	-	-	V
Collector-base breakdown voltage $I_C = 10 \mu\text{A}, I_E = 0$	$V_{(BR)CBO}$	40	-	-	
Emitter-base breakdown voltage $I_E = 10 \mu\text{A}, I_C = 0$	$V_{(BR)EBO}$	5	-	-	
Collector-base cutoff current $V_{CB} = 30 \text{ V}, I_E = 0$	I_{CBO}	-	-	50	nA
DC current gain ¹⁾ $I_C = 100 \mu\text{A}, V_{CE} = 1 \text{ V}$ $I_C = 1 \text{ mA}, V_{CE} = 1 \text{ V}$ $I_C = 10 \text{ mA}, V_{CE} = 1 \text{ V}$ $I_C = 50 \text{ mA}, V_{CE} = 1 \text{ V}$ $I_C = 100 \text{ mA}, V_{CE} = 1 \text{ V}$	h_{FE}	60 80 100 60 30	- - - - -	- - 300 - -	-
Collector-emitter saturation voltage ¹⁾ $I_C = 10 \text{ mA}, I_B = 1 \text{ mA}$ $I_C = 50 \text{ mA}, I_B = 5 \text{ mA}$	V_{CEsat}	- -	- -	0.25 0.4	V
Base emitter saturation voltage ⁻¹⁾ $I_C = 10 \text{ mA}, I_B = 1 \text{ mA}$ $I_C = 50 \text{ mA}, I_B = 5 \text{ mA}$	V_{BEsat}	0.65 -	- -	0.85 0.95	

¹Puls test: $t \leq 300 \mu\text{s}$, $D = 2\%$

AC Characteristics

Transition frequency $I_C = 10 \text{ mA}, V_{CE} = 20 \text{ V}, f = 100 \text{ MHz}$	f_T	250	-	-	MHz
Collector-base capacitance $V_{CB} = 5 \text{ V}, f = 1 \text{ MHz}$	C_{cb}	-	-	4.5	pF
Emitter-base capacitance $V_{EB} = 0.5 \text{ V}, f = 1 \text{ MHz}$	C_{eb}	-	-	10	
Short-circuit input impedance $I_C = 1 \text{ mA}, V_{CE} = 10 \text{ V}, f = 1 \text{ kHz}$	h_{11e}	2	-	12	k Ω
Open-circuit reverse voltage transf. ratio $I_C = 1 \text{ mA}, V_{CE} = 10 \text{ V}, f = 1 \text{ kHz}$	h_{12e}	0.1	-	10	10^{-4}
Short-circuit forward current transf. ratio $I_C = 1 \text{ mA}, V_{CE} = 10 \text{ V}, f = 1 \text{ kHz}$	h_{21e}	100	-	400	-
Open-circuit output admittance $I_C = 1 \text{ mA}, V_{CE} = 10 \text{ V}, f = 1 \text{ kHz}$	h_{22e}	3	-	60	μS
Delay time $V_{CC} = 3 \text{ V}, I_C = 10 \text{ mA}, I_{B1} = 1 \text{ mA}, V_{BE(off)} = 0.5 \text{ V}$	t_d	-	-	35	ns
Rise time $V_{CC} = 3 \text{ V}, I_C = 10 \text{ mA}, I_{B1} = 1 \text{ mA}, V_{BE(off)} = 0.5 \text{ V}$	t_r	-	-	35	
Storage time $V_{CC} = 3 \text{ V}, I_C = 10 \text{ mA}, I_{B1} = I_{B2} = 1 \text{ mA}$	t_{stg}	-	-	225	
Fall time $V_{CC} = 3 \text{ V}, I_C = 10 \text{ mA}, I_{B1} = I_{B2} = 1 \text{ mA}$	t_f	-	-	75	
Noise figure $I_C = 100 \mu\text{A}, V_{CE} = 5 \text{ V}, f = 1 \text{ kHz}, \Delta f = 200 \text{ Hz}, R_S = 1 \text{ k}\Omega$	F	-	-	4	dB

Test circuit

Delay and rise time

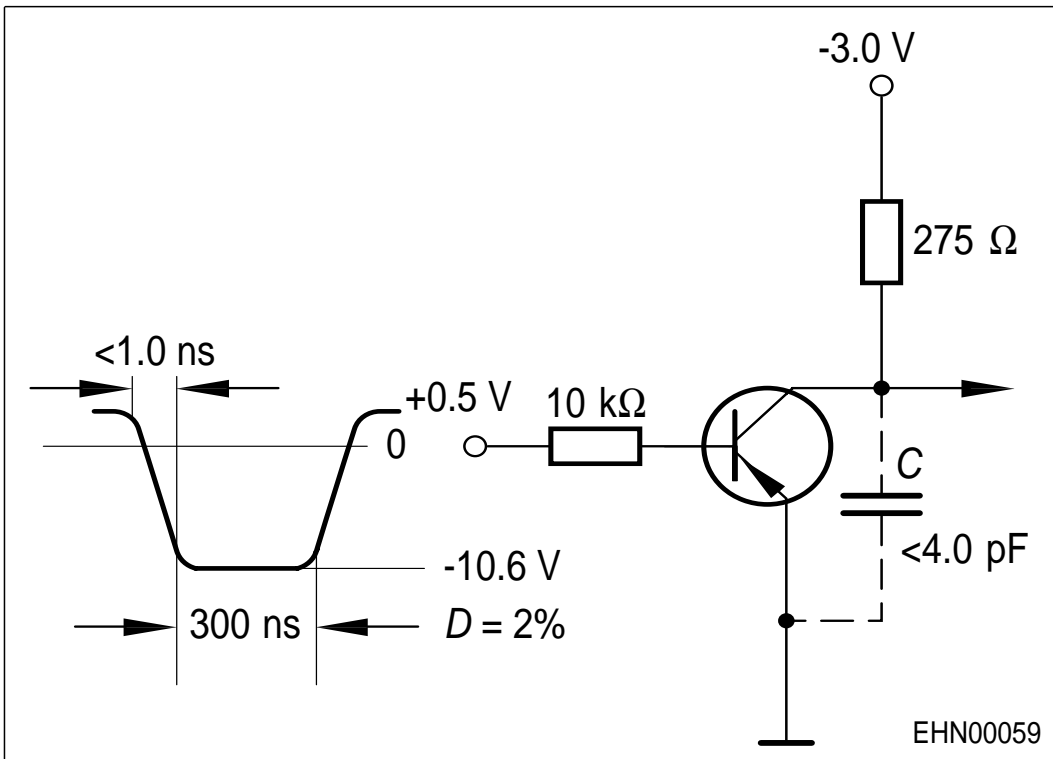

Storage and fall time

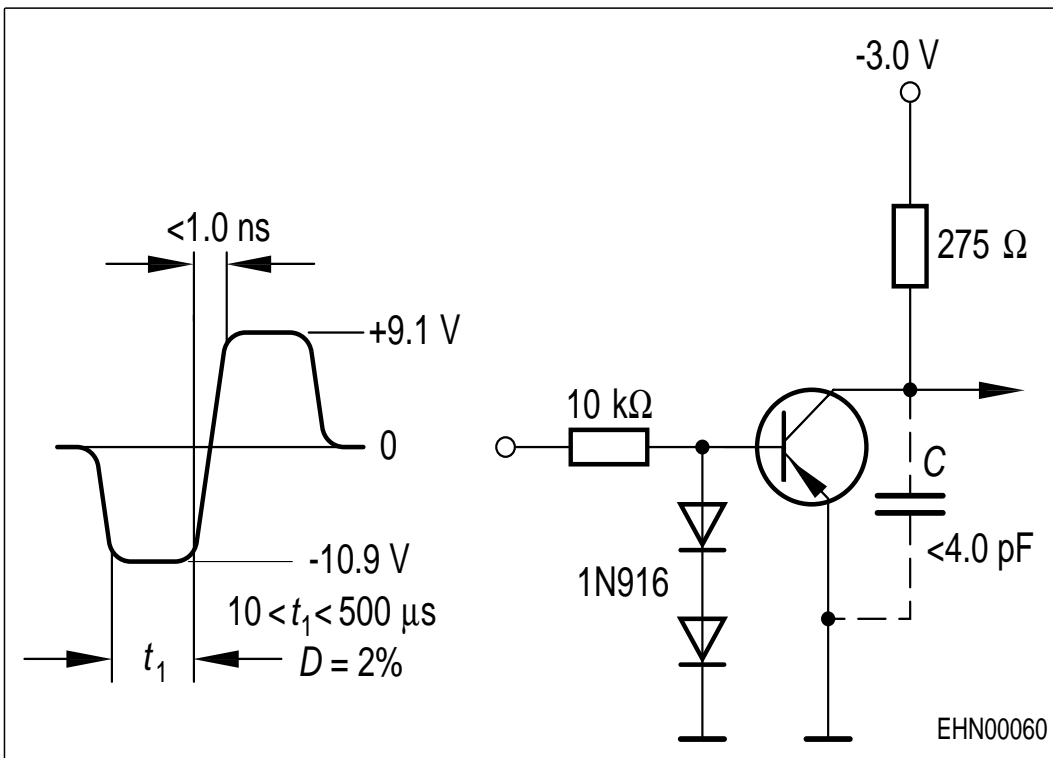

DC current gain $h_{FE} = f(I_C)$

$V_{CE} = 1\text{ V}$, normalized

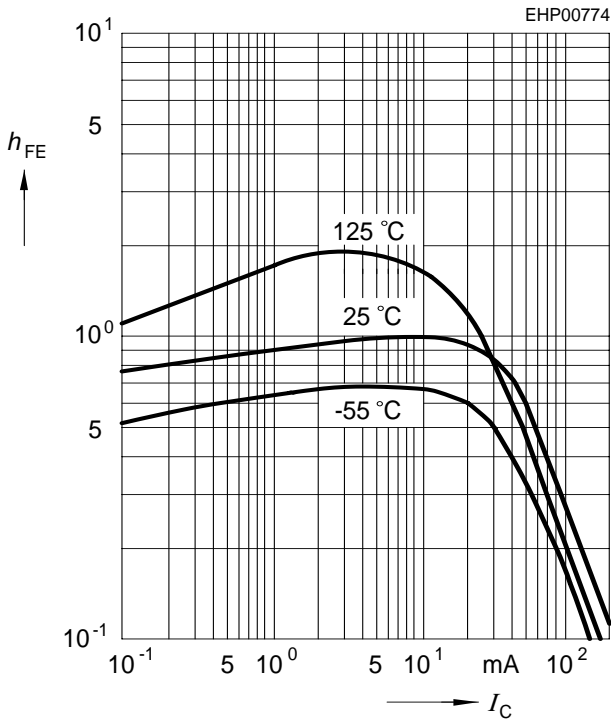

Saturation voltage $I_C = f(V_{BEsat}; V_{CEsat})$

$h_{FE} = 10$

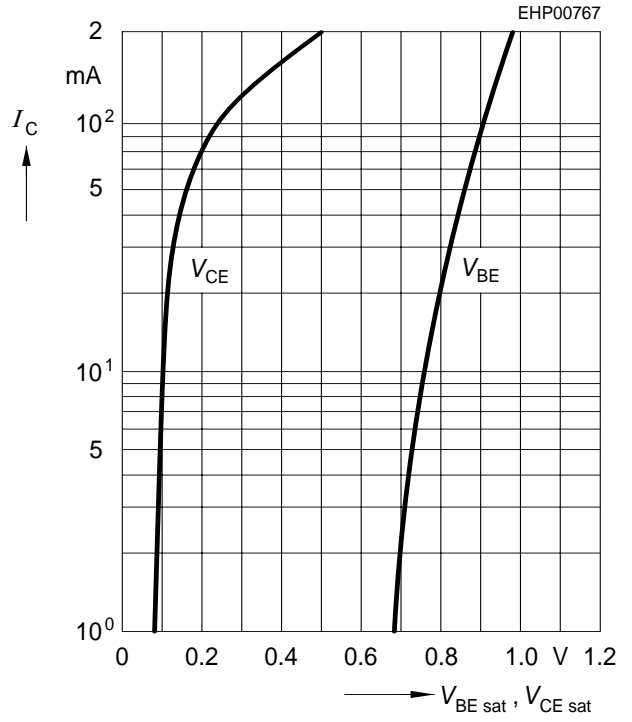

Total power dissipation $P_{tot} = f(T_A^*; T_S)$

* Package mounted on epoxy

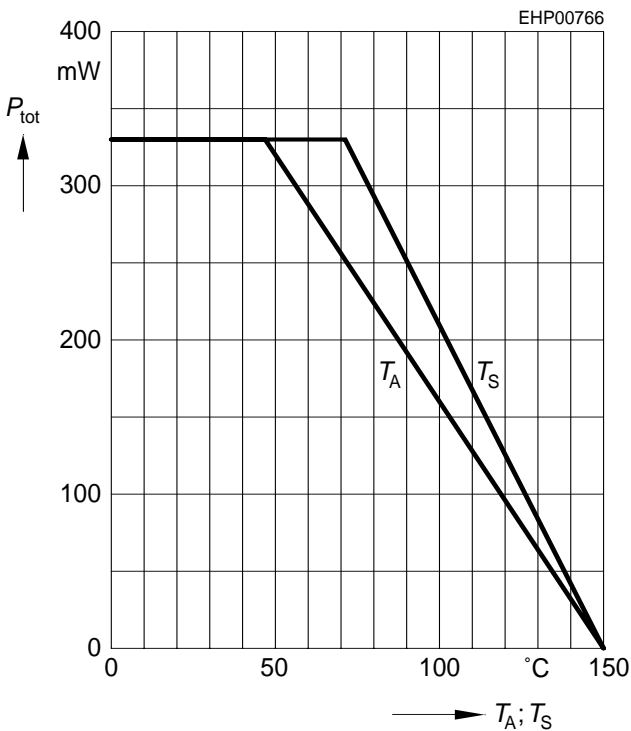

Permissible Pulse Load

$P_{totmax}/P_{totDC} = f(t_p)$

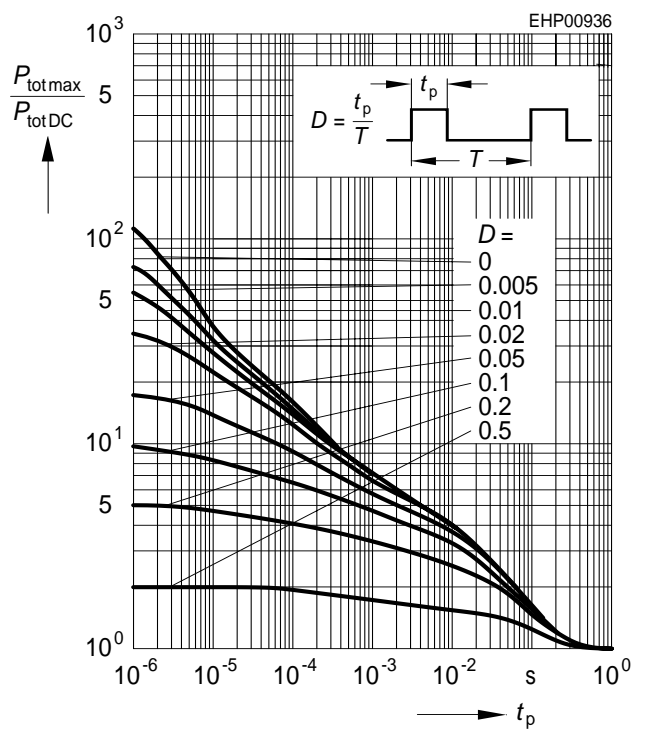

Short-circuit forward current

transfer ratio $h_{21e} = f(I_C)$

$V_{CE} = 10V, f = 1MHz$

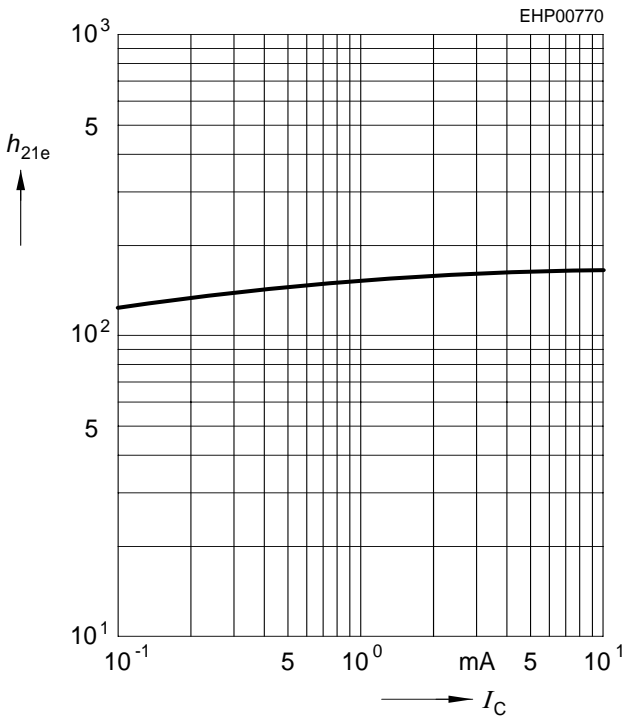

Open-circuit reverse voltage

transfer ratio $h_{12e} = f(I_C)$

$V_{CE} = 10V, f = 1kHz$

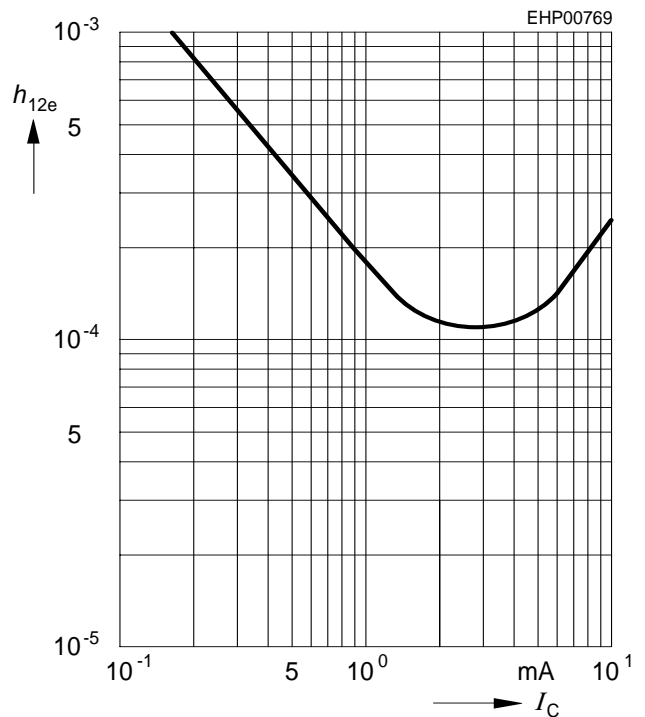

Open-circuit output admittance

$h_{22e} = f(I_C)$

$V_{CE} = 10V, f = 1MHz$

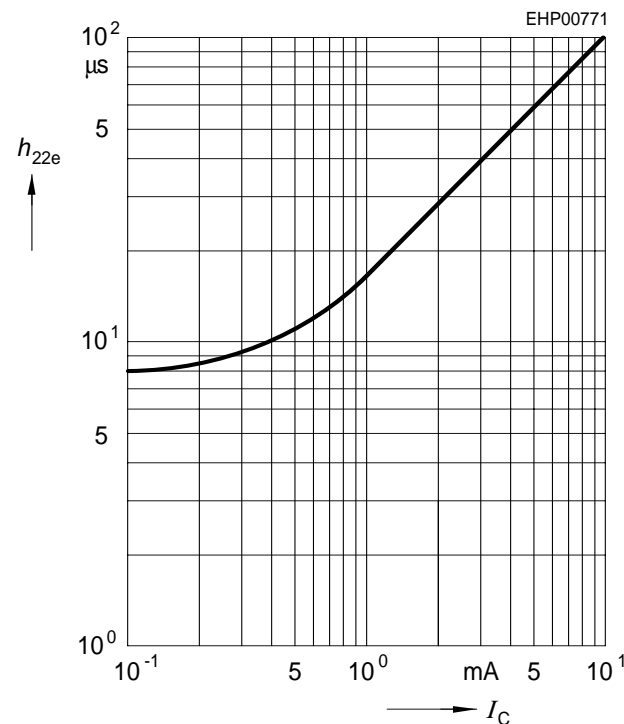

Input impedance

$h_{11e} = f(I_C)$

$V_{CE} = 10V, f = 1kHz$

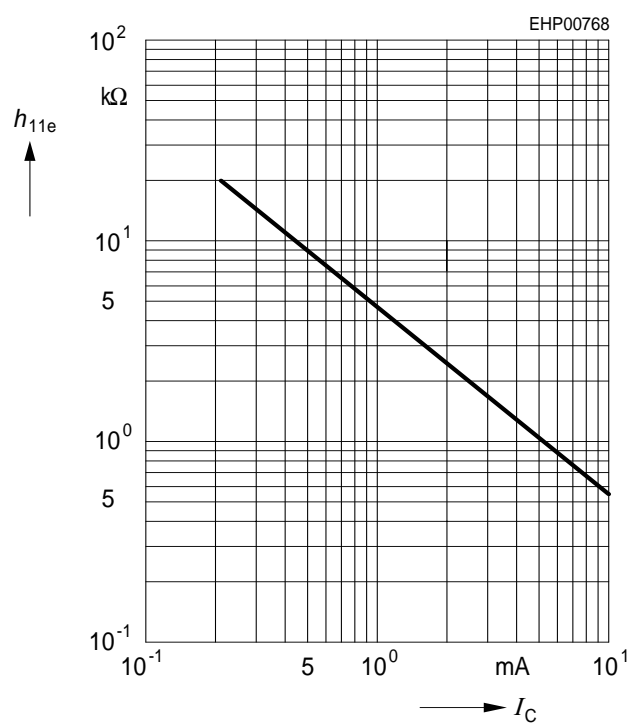

Delay time $t_d = f(I_C)$

Rise time $t_r = f(I_C)$

Fall time $t_f = f(I_C)$

