

S G S-THOMSON

HIGH-FREQUENCY OSCILLATORS AND AMPLIFIERS

The BFX73, 2N918 and 2N3600 are silicon planar epitaxial NPN transistors in Jedec TO-72 metal case.

They are designed for low-noise VHF amplifiers, oscillators up to 1 GHz, non-neutralized IF amplifiers and non-saturating circuits with rise and fall times of less than 2.5 ns.

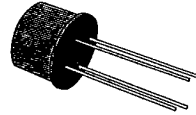

TO-72

INTERNAL SCHEMATIC DIAGRAM

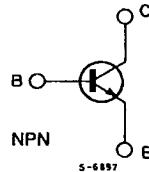

ABSOLUTE MAXIMUM RATINGS

Symbol	Parameter	Value	Unit
V_{CBO}	Collector-base Voltage ($I_E = 0$)	30	V
V_{CEO}	Collector-emitter Voltage ($I_B = 0$)	15	V
V_{EBO}	Emitter-base Voltage ($I_C = 0$)	3	V
I_C	Collector Current	50	mA
P_{tot}	Total Power Dissipation at $T_{amb} \leq 25^\circ\text{C}$ at $T_{amb} \leq 25^\circ\text{C}$	200	mW
		300	mW
T_{stg}, T_J	Storage and Junction Temperature	- 65 to 200	$^\circ\text{C}$

November 1988

1/5

171

THERMAL DATA

R _{th j-case}	Thermal Resistance Junction-case	Max	584	°C/W
R _{th j-amb}	Thermal Resistance Junction-ambient	Max	875	°C/W

ELECTRICAL CHARACTERISTICS (T_{amb} = 25 °C unless otherwise specified)

Symbol	Parameter	Test Conditions	Min.	Typ.	Max.	Unit
I _{CB0}	Collector Cutoff Current (I _E = 0)	V _{CB} = 15 V V _{CB} = 15 V T _{amb} = 150 °C			10 1	nA μA
V _{(BR)CBO}	Collector-base Breakdown Voltage (I _E = 0)	I _C = 1 μA	30			V
V _{CEO (sus)}	Collector-emitter Sustaining Voltage (I _B = 0)	I _C = 3 mA	15			V
V _{(BR) EBO}	Emitter-base Breakdown Voltage (I _C = 0)	I _E = 10 μA	3			V
V _{CE (sat)}	Collector-emitter Saturation Voltage	I _C = 10 mA I _B = 1 mA			0.4	V
V _{BE (sat)}	Base-emitter Saturation Voltage	I _C = 10 mA I _B = 1 mA			1	V
h _{FE}	DC Current Gain	I _C = 3 mA V _{CE} = 1 V for 2N918/BFX73 for 2N3600	20 20	50	150	
f _T	Transition Frequency	for 2N918/BFX73 I _C = 4 mA V _{CE} = 10 V f = 100 MHz for 2N3600 I _C = 5 mA V _{CE} = 6 V f = 100 MHz	600 850	900	1500	MHz MHz
C _{EBO}	Emitter-base Capacitance	I _C = 0 V _{EB} = 0.5 V f = 1 MHz for 2N918/BFX73 for 2N3600		1.4	2	pF pF
C _{OBO}	Collector-base Capacitance (for 2N918/BFX73 only)	I _E = 0 f = 1 MHz V _{CE} = 0 V V _{CE} = 10 V		1.8 1	3 1.7	pF pF
C _{ro}	Reverse Capacitance (for 2N3600 only)	I _C = 0 V _{CB} = 10 V f = 1 MHz			1	pF
NF	Noise Figure	I _C = 1.5 mA V _{CE} = 6 V R _g = 50 Ω f = 200 MHz for 2N3600 I _C = 1 mA V _{CE} = 6 V R _g = 400 Ω f = 60 MHz for 2N918/BFX73 for 2N3600			4.5 6 3	dB dB dB
G _{pe}	Power Gain	R _g = 50 Ω f = 200 MHz for 2N918/BFX73 I _C = 6 mA V _{CE} = 12 V for 2N3600 I _C = 5 mA V _{CE} = 6 V	15 17	21	24	dB dB

* See test circuits.

SGS-THOMSON
ELECTRICAL CHARACTERISTICS (continued)

T-31-15

Symbol	Parameter	Test Conditions	Min.	Typ.	Max.	Unit
P_o^*	Output Power	$I_C = 12 \text{ mA}$ $V_{CB} = 10 \text{ V}$ $f = 500 \text{ MHz}$ for 2N918/BFX73 for 2N3600	30 20	40		mW mW
π	Collector Efficiency (for 2N918/BFX73 only)	$I_C = 12 \text{ mA}$ $V_{CB} = 10 \text{ V}$ $f = 500 \text{ MHz}$	25			%
$r_{b'b}, C_{b'b'c}$	Feedback Time Constant (for 2N3600 only)	$I_C = 5 \text{ mA}$ $V_{CB} = 6 \text{ V}$ $f = 31.9 \text{ MHz}$	4		15	ps

DC Current Gain.

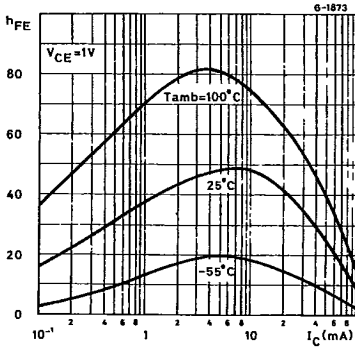

Transition Frequency.

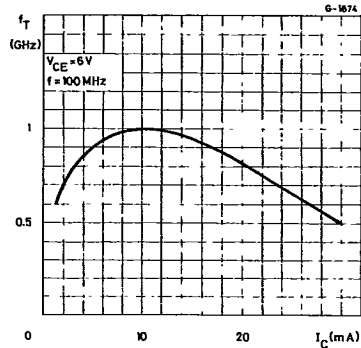

Input Admittance vs. Collector Current.

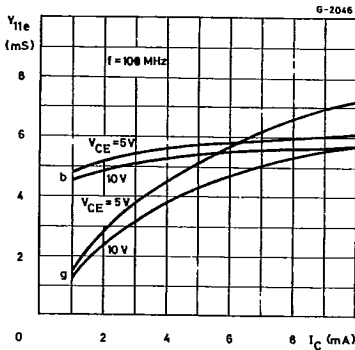

Forward Transadmittance vs. Collector Current.

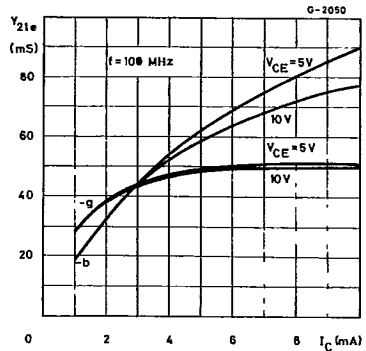

30E D 7929237 0030992 4

Reverse Transadmittance vs. Collector Current.

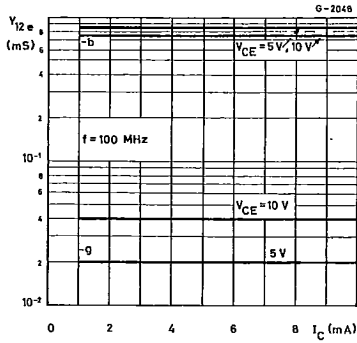

Output Admittance vs. Collector Current.

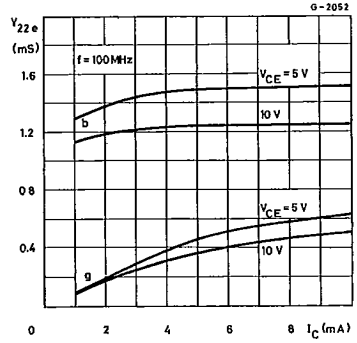

Input Admittance vs. Frequency.

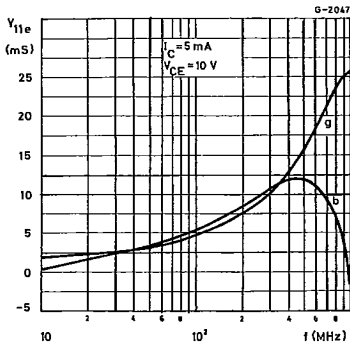

Forward Transadmittance vs. Frequency.

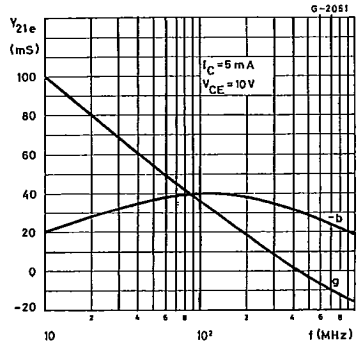

Reverse Transadmittance vs. Frequency.

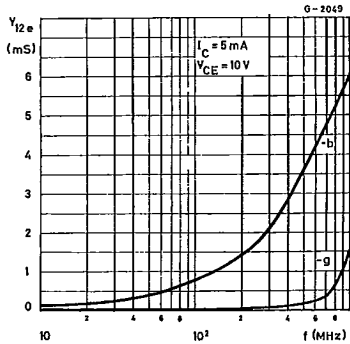

Output Admittance vs. Frequency.

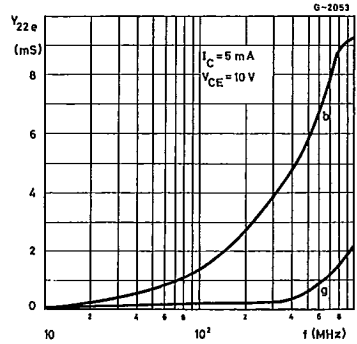

SGS-THOMSON

Figure 1 : 500 MHz Oscillator Test Circuit.

T-31-15

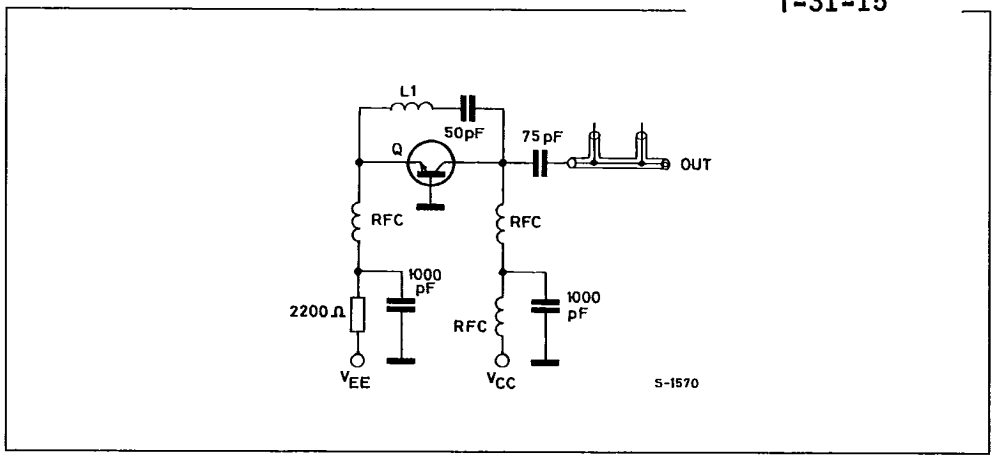

S-1570