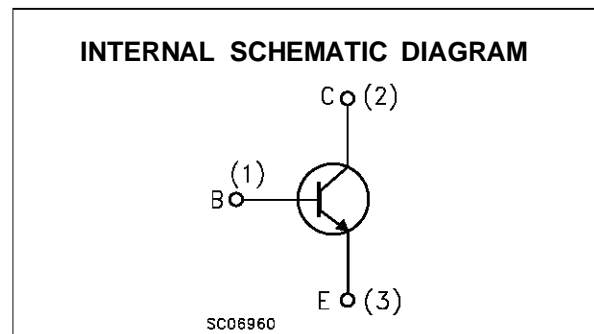
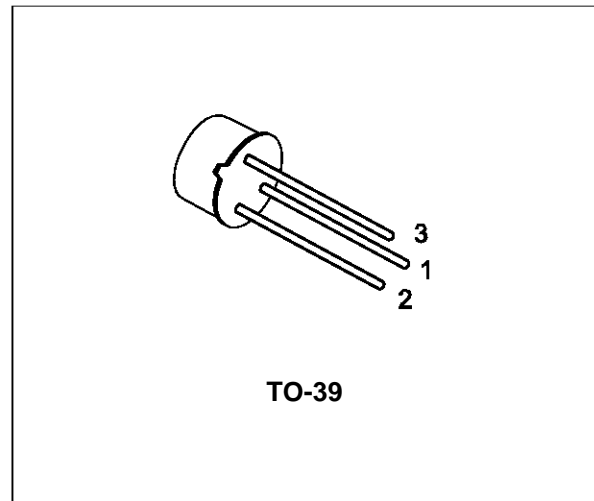

GENERAL PURPOSE TRANSISTORS

DESCRIPTION

The BC141 is a silicon planar epitaxial NPN transistors in Jedec TO-39 metal case. They are particularly designed for audio amplifiers and switching application up to 1A.

The complementary PNP type is the BC161.

ABSOLUTE MAXIMUM RATINGS

Symbol	Parameter	Value	Unit
V_{CBO}	Collector-Base Voltage ($I_E = 0$)	100	V
V_{CEO}	Collector-Emitter Voltage ($I_B = 0$)	60	V
V_{EBO}	Emitter-Base Voltage ($I_C = 0$)	7	V
I_C	Collector Current	1	A
I_B	Base Current	0.1	A
P_{tot}	Total Dissipation at $T_{amb} \leq 45\text{ }^\circ\text{C}$ at $T_{case} \leq 45\text{ }^\circ\text{C}$	0.65	W
		3.7	W
T_{stg}	Storage Temperature	-55 to 175	$^\circ\text{C}$
T_j	Max. Operating Junction Temperature	175	$^\circ\text{C}$

BC141

THERMAL DATA

$R_{thj-case}$	Thermal Resistance Junction-Case	Max	35	$^{\circ}C/W$
$R_{thj-amb}$	Thermal Resistance Junction-Ambient	Max	200	$^{\circ}C/W$

ELECTRICAL CHARACTERISTICS ($T_{case} = 25^{\circ}C$ unless otherwise specified)

Symbol	Parameter	Test Conditions	Min.	Typ.	Max.	Unit
I_{CES}	Collector Cut-off Current ($V_{BE} = 0$)	$V_{CE} = 60 V$ $V_{CE} = 60 V \quad T_{amb} = 150^{\circ}C$			100 100	nA μA
$V_{(BR)CBO}^*$	Collector-Base Breakdown Voltage ($I_E = 0$)	$I_C = 100 \mu A$	100			V
$V_{(BR)CEO}^*$	Collector-Emitter Breakdown Voltage ($I_B = 0$)	$I_C = 30 mA$	60			V
$V_{(BR)EBO}^*$	Emitter-Base Breakdown Voltage ($I_C = 0$)	$I_E = 100 \mu A$	7			V
$V_{CE(sat)}^*$	Collector-Emitter Saturation Voltage	$I_C = 100 mA \quad I_B = 10 mA$ $I_C = 500 mA \quad I_B = 50 mA$ $I_C = 1 A \quad I_B = 100 mA$		0.1 0.35 0.6	1	V V V
$V_{BE(on)}^*$	Base-Emitter On Voltage	$I_C = 1 A \quad V_{CE} = 1 V$		1.25	1.8	V
h_{FE}^*	DC Current Gain	$I_C = 100 \mu A \quad V_{CE} = 1 V$ for BC141 for BC141 Gr. 6 for BC141 Gr. 10 for BC141 Gr. 16 $I_C = 100 mA \quad V_{CE} = 1 V$ for BC141 for BC141 Gr. 6 for BC141 Gr. 10 for BC141 Gr. 16 $I_C = 1 A \quad V_{CE} = 1 V$ for BC141 for BC141 Gr. 6 for BC141 Gr. 10 for BC141 Gr. 16		75 28 40 90 40 40 63 63 100 26 15 20 30	250 100 160 250	
f_T	Transition Frequency	$I_C = 50 mA \quad V_{CE} = 10 V$	50			MHz
C_{CBO}	Collector Base Capacitance	$I_E = 0 \quad V_{CB} = 5 V \quad f = 1 MHz$		12	25	pF
t_{on}	Turn-on Time	$I_C = 100 mA \quad I_{B1} = 5 mA$			250	ns
t_{off}	Turn-off Time	$I_C = 100 mA \quad I_{B1} = I_{B2} = 5 mA$			850	ns

* Pulsed: Pulse duration = 300 μs , duty cycle $\leq 1\%$

Collector-emitter Saturation Voltage.

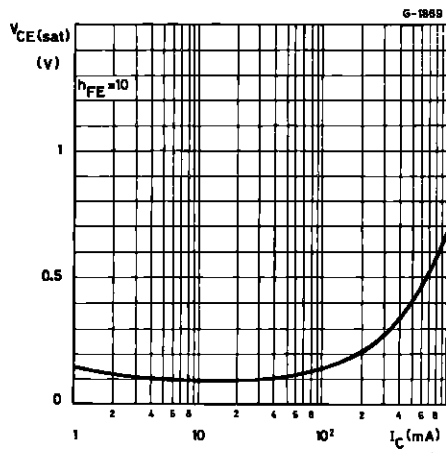

Base-emitter Voltage.

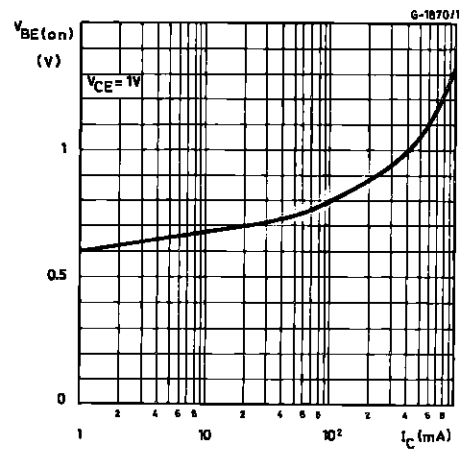

DC Current Gain.

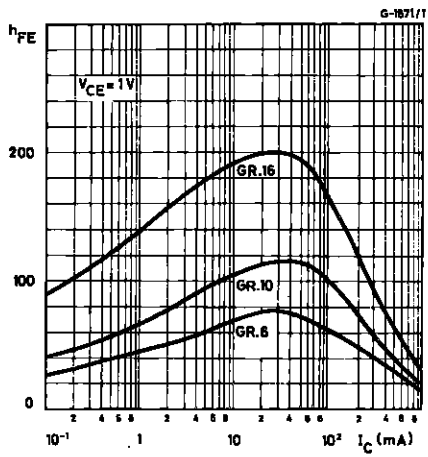

Transition Frequency.

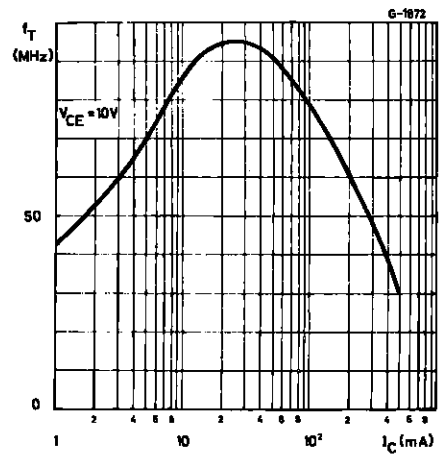

TO-39 MECHANICAL DATA

DIM.	mm			inch		
	MIN.	TYP.	MAX.	MIN.	TYP.	MAX.
A	12.7			0.500		
B			0.49			0.019
D			6.6			0.260
E			8.5			0.334
F			9.4			0.370
G	5.08			0.200		
H			1.2			0.047
I			0.9			0.035
L	45° (typ.)					

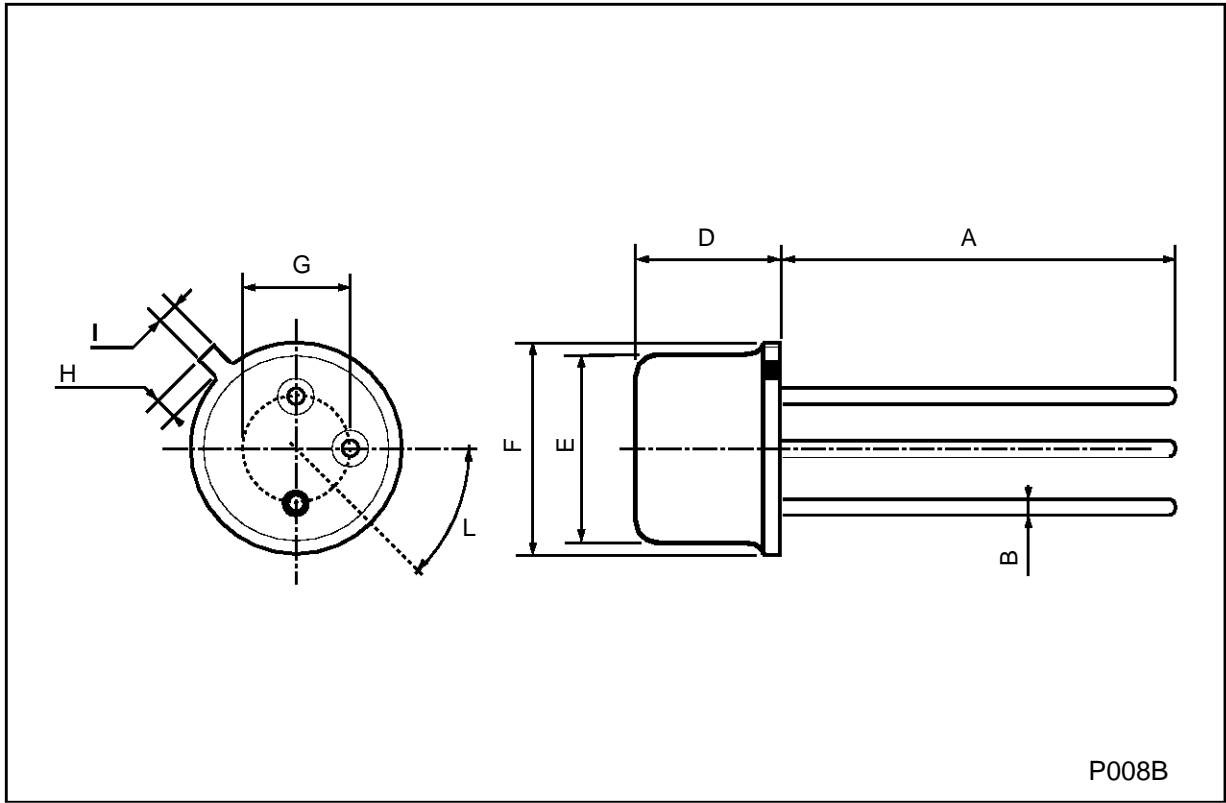

P008B

Information furnished is believed to be accurate and reliable. However, SGS-THOMSON Microelectronics assumes no responsibility for the consequences of use of such information nor for any infringement of patents or other rights of third parties which may result from its use. No license is granted by implication or otherwise under any patent or patent rights of SGS-THOMSON Microelectronics. Specifications mentioned in this publication are subject to change without notice. This publication supersedes and replaces all information previously supplied. SGS-THOMSON Microelectronics products are not authorized for use as critical components in life support devices or systems without express written approval of SGS-THOMSON Microelectronics.

© 1997 SGS-THOMSON Microelectronics - Printed in Italy - All Rights Reserved

SGS-THOMSON Microelectronics GROUP OF COMPANIES

Australia - Brazil - Canada - China - France - Germany - Italy - Japan - Korea - Malaysia - Malta - Morocco - The Netherlands -
Singapore - Spain - Sweden - Switzerland - Taiwan - Thailand - United Kingdom - U.S.A

...