



SD2931

RF POWER TRANSISTORS HF/VHF/UHF N-CHANNEL MOSFETs

- GOLD METALLIZATION
- EXCELLENT THERMAL STABILITY
- COMMON SOURCE CONFIGURATION
- $P_{OUT} = 150 \text{ W MIN. WITH } 14 \text{ dB GAIN @ } 175 \text{ MHz}$

DESCRIPTION

The SD2931 is a gold metallized N-Channel MOS field-effect RF power transistor. It is intended for use in 50 V dc large signal applications up to 230 MHz.

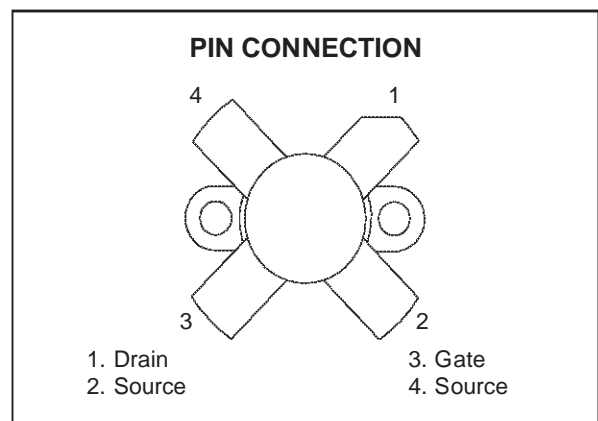
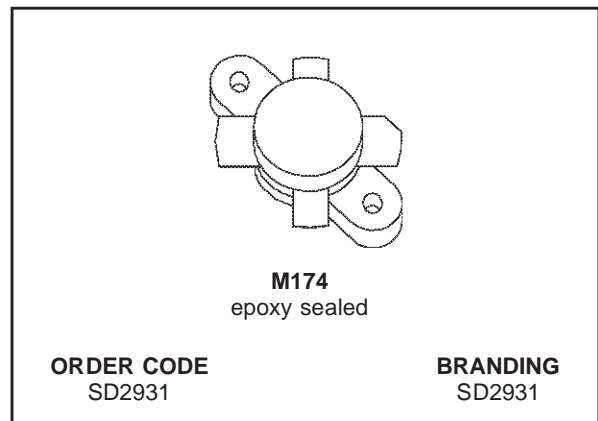

ABSOLUTE MAXIMUM RATINGS ($T_{CASE} = 25 \text{ }^\circ\text{C}$)

Symbol	Parameter	Value	Unit
$V_{(BR)DSS}$	Drain Source Voltage	125	V
V_{DGR}	Drain-Gate Voltage ($R_{GS} = 1M\Omega$)	125	V
V_{GS}	Gate-Source Voltage	± 20	V
I_D	Drain Current	20	A
P_{DISS}	Power Dissipation	292	W
T_j	Max. Operating Junction Temperature	200	$^\circ\text{C}$
T_{STG}	Storage Temperature	-65 to +150	$^\circ\text{C}$

THERMAL DATA

$R_{th(j-c)}$	Junction -Case Thermal Resistance	0.6	$^\circ\text{C/W}$
---------------	-----------------------------------	-----	--------------------

ELECTRICAL SPECIFICATION ($T_{CASE} = 25^{\circ}C$)

STATIC

Symbol	Test Conditions		Min.	Typ.	Max.	Unit
$V_{(BR)DSS}$	$V_{GS} = 0\text{ V}$	$I_{DS} = 100\text{ mA}$	125			V
I_{DSS}	$V_{GS} = 0\text{ V}$	$V_{DS} = 50\text{ V}$			5	mA
I_{GSS}	$V_{GS} = 20\text{ V}$	$V_{DS} = 0\text{ V}$			5	μA
$V_{GS(Q)*}$	$V_{DS} = 10\text{ V}$	$I_D = 250\text{ mA}$	1.5		4.0	V
$V_{DS(ON)}$	$V_{GS} = 10\text{ V}$	$I_D = 10\text{ A}$			3.0	V
G_{FS}	$V_{DS} = 10\text{ V}$	$I_D = 5\text{ A}$	5			mho
C_{ISS}	$V_{GS} = 0\text{ V}$	$V_{DS} = 50\text{ V}$		480		pF
C_{OSS}	$V_{GS} = 0\text{ V}$	$V_{DS} = 50\text{ V}$		190		pF
C_{RSS}	$V_{GS} = 0\text{ V}$	$V_{DS} = 50\text{ V}$		18		pF

* $V_{GS(Q)}$ sorted with alpha/numeric code marked on unit.

REF. 7163910B

DYNAMIC

Symbol	Test Conditions		Min.	Typ.	Max.	Unit
P_{OUT}	$V_{DD} = 50\text{ V}$	$I_{DQ} = 250\text{ mA}$ $f = 175\text{ MHz}$	150			W
G_{PS}	$V_{DD} = 50\text{ V}$	$I_{DQ} = 250\text{ mA}$ $P_{OUT} = 150\text{ W}$ $f = 175\text{ MHz}$	14	15		dB
η_D	$V_{DD} = 50\text{ V}$	$I_{DQ} = 250\text{ mA}$ $P_{OUT} = 150\text{ W}$ $f = 175\text{ MHz}$	55	65		%
Load Mismatch	$V_{DD} = 50\text{ V}$	$I_{DQ} = 250\text{ mA}$ $P_{OUT} = 150\text{ W}$ $f = 175\text{ MHz}$ All Phase Angles	10:1			VSWR

IMPEDANCE DATA

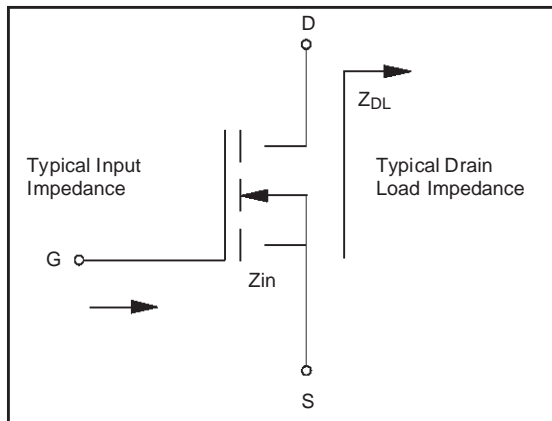

FREQ	$Z_{IN} (\Omega)$	$Z_{DL} (\Omega)$
30 MHz	$1.7 - j 5.7$	$6.8 + j 0.9$
175 MHz	$1.2 - j 2.0$	$2.0 + j 2.4$

V_{GS} SORTS

AA	1.5 - 1.6	J	2.8 - 2.9
BB	1.6 - 1.7	K	2.9 - 3.0
CC	1.7 - 1.8	L	3.0 - 3.1
DD	1.8 - 1.9	M	3.1 - 3.2
EE	1.9 - 2.0	N	3.2 - 3.3
A	2.0 - 2.1	P	3.3 - 3.4
B	2.1 - 2.2	Q	3.4 - 3.5
C	2.2 - 2.3	R	3.5 - 3.6
D	2.3 - 2.4	S	3.6 - 3.7
E	2.4 - 2.5	T	3.7 - 3.8
F	2.5 - 2.6	U	3.8 - 3.9
G	2.6 - 2.7	V	3.9 - 4.0
H	2.7 - 2.8		

TYPICAL PERFORMANCE

Capacitance vs. Drain-Source Voltage

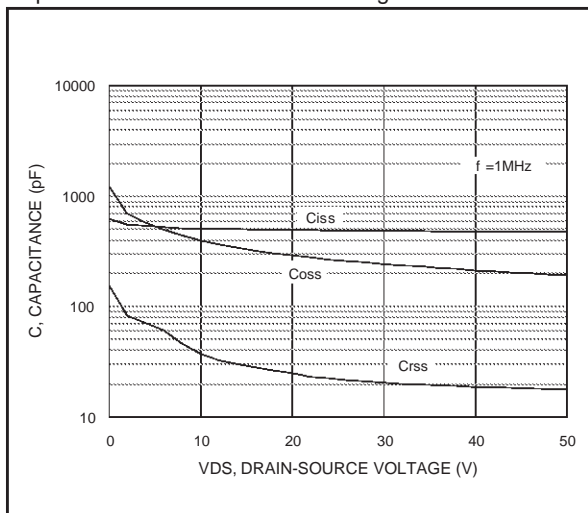

Drain Current vs. Gate Voltage

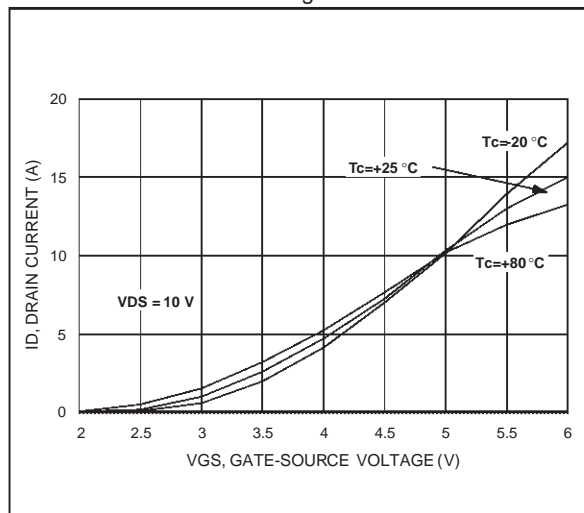

Gate-Source Voltage vs. Case Temperature

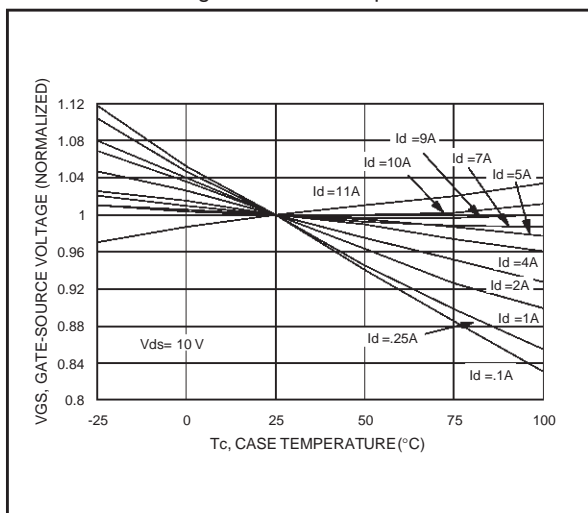

Maximum Thermal Resistance vs. Case Temperature

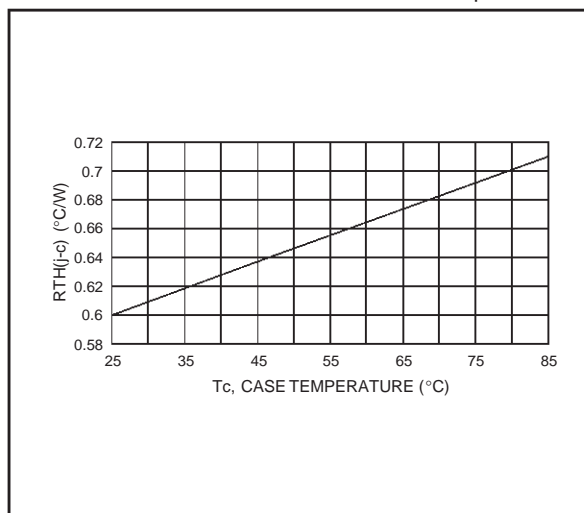

Safe Operating Area

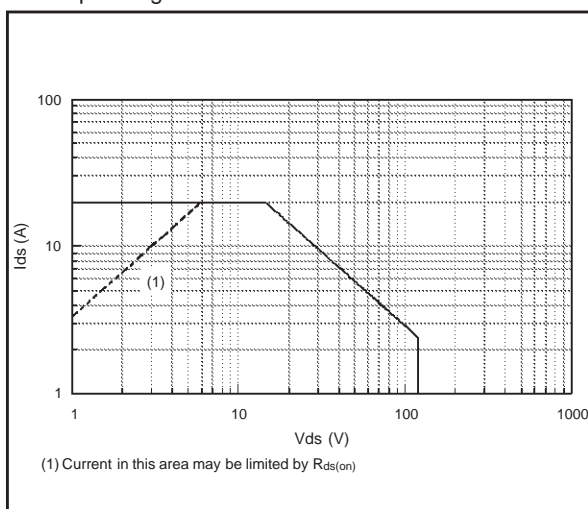

SD2931

TYPICAL PERFORMANCE (175 MHz)

Output Power vs. Input Power

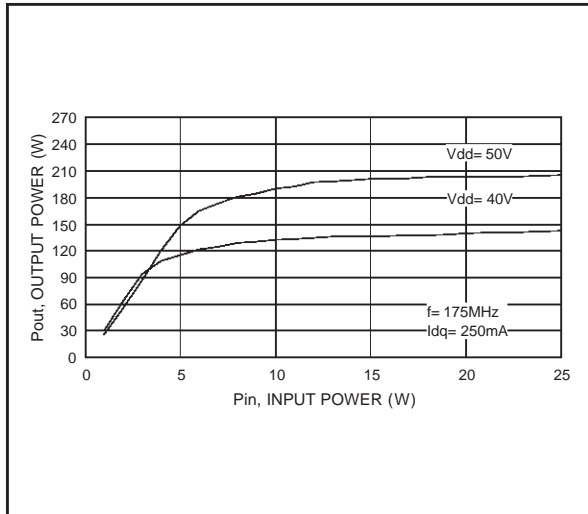

Output Power vs. Input Power

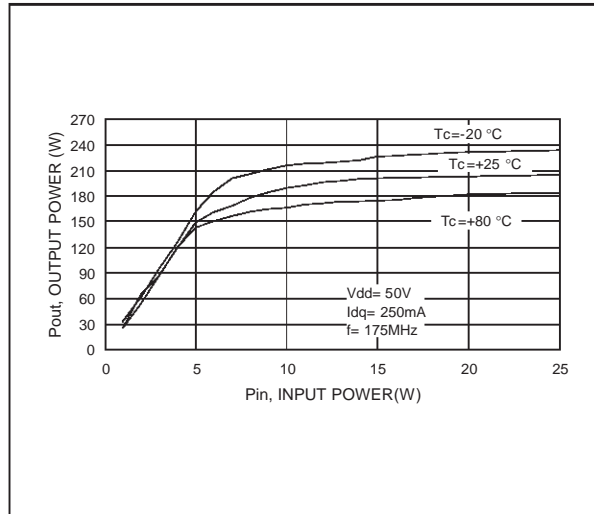

Power Gain vs. Output Power

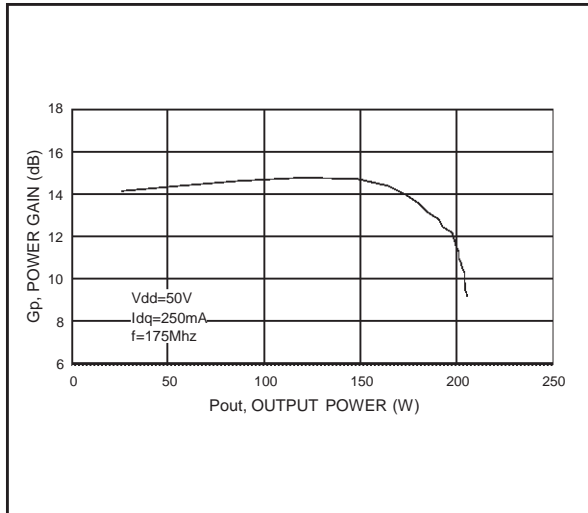

Efficiency vs. Output Power

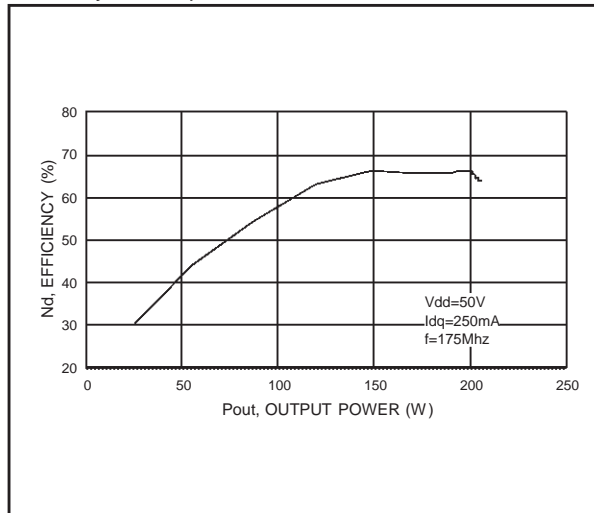

Output Power vs. Supply Voltage

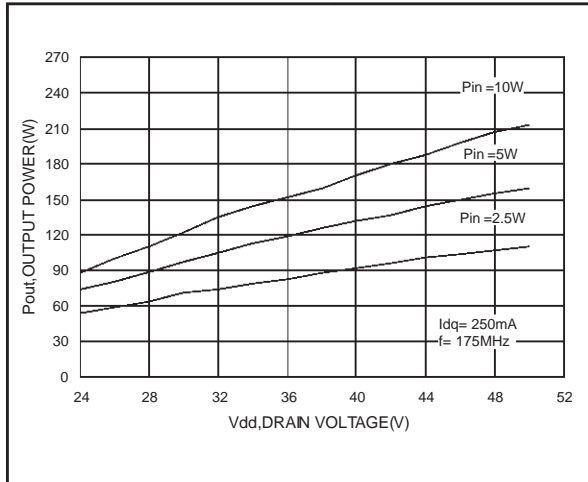

Drain Current vs. Gate-Source Voltage

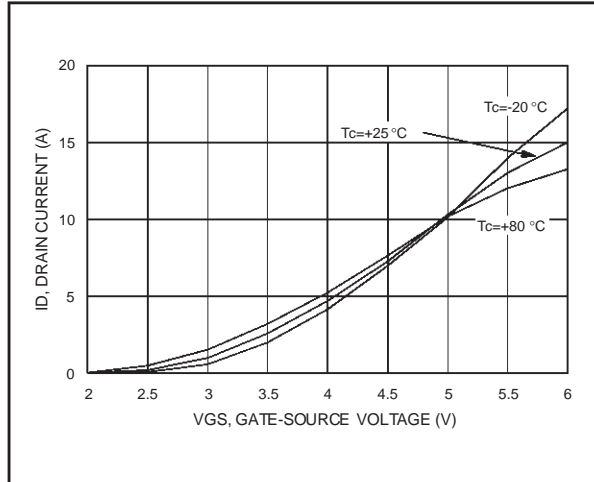

175 MHz Test Circuit Schematic (Production Test Circuit)

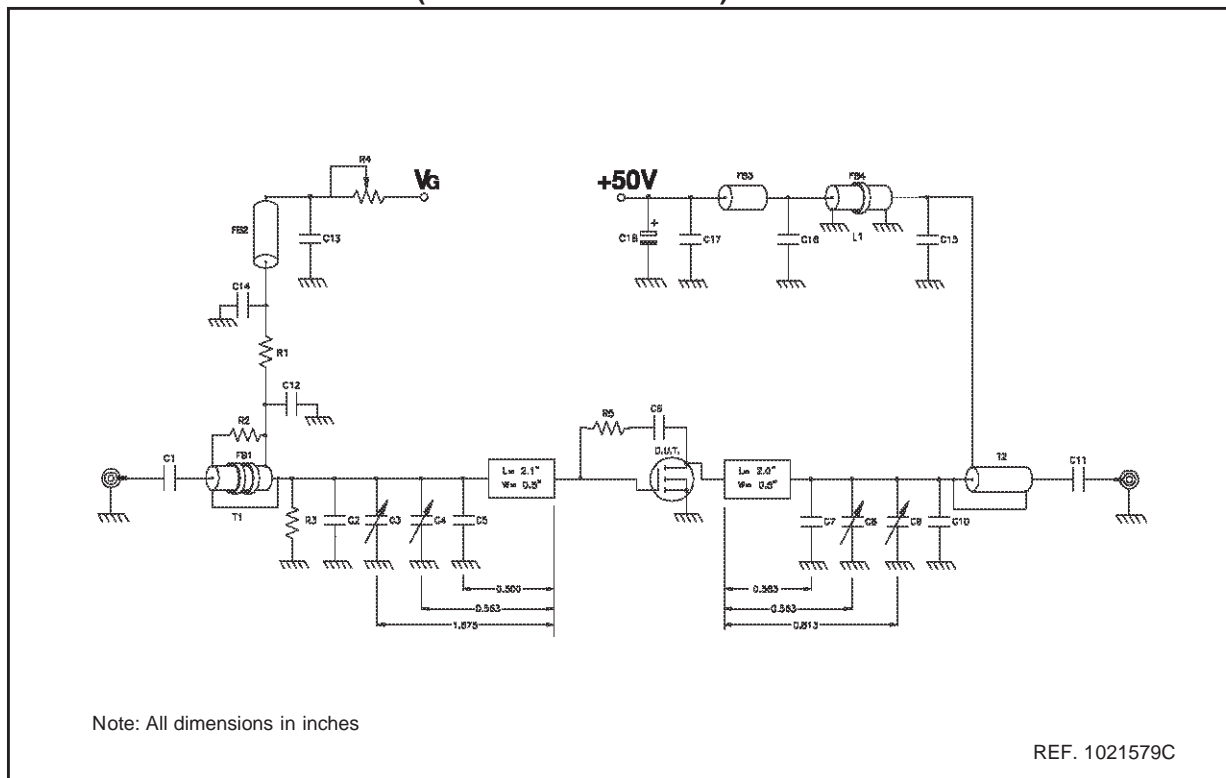

175 MHz Test Circuit Component Part List

T1	4:1 Transformer, 25 ohm Flexible Coax .090 OD 6" Long
T2	1:4 Transformer, 25 ohm Semi-Rigid Coax .141 OD 6" Long
FB1	Toroid X 2, 0.5" OD .312" ID 850 μ 2 Turns
FB2, FB3	VK200
FB4	Shield Bead, 1" OD 0.5" ID 850 μ 3 Turns
L1	1/4 Wave Choke, 50 ohm Semi-Rigid Coax .141 OD 12" Long
PCB	0.62" Woven Fiberglass, 1 oz. Copper, 2 Sides, $\epsilon_r = 2.55$
R1, R3	470 ohm 1 W Chip Resistor
R2	360 ohm 1/2 W Resistor
R4	20 Kohm 10 Turn Potentiometer
R5	560 ohm 1 W Resistor
C1, C11	470 pF ATC Chip Cap
C2	43 pF ATC Chip Cap
C3, C8, C9	Arco 404, 12-65 pF
C4	Arco 423, 16-100 pF
C5	120 pF ATC Chip Cap
C6	0.01 μ F ATC Chip Cap
C7	30 pF ATC Chip Cap
C10	91 pF ATC Chip Cap
C12, C15	1200 pF ATC Chip Cap
C13, C14, C16, C17	0.01 μ F / 500 V Chip Cap
C18	10 μ F 63 V Electrolytic Capacitor

175 MHz Test Circuit Photomaster

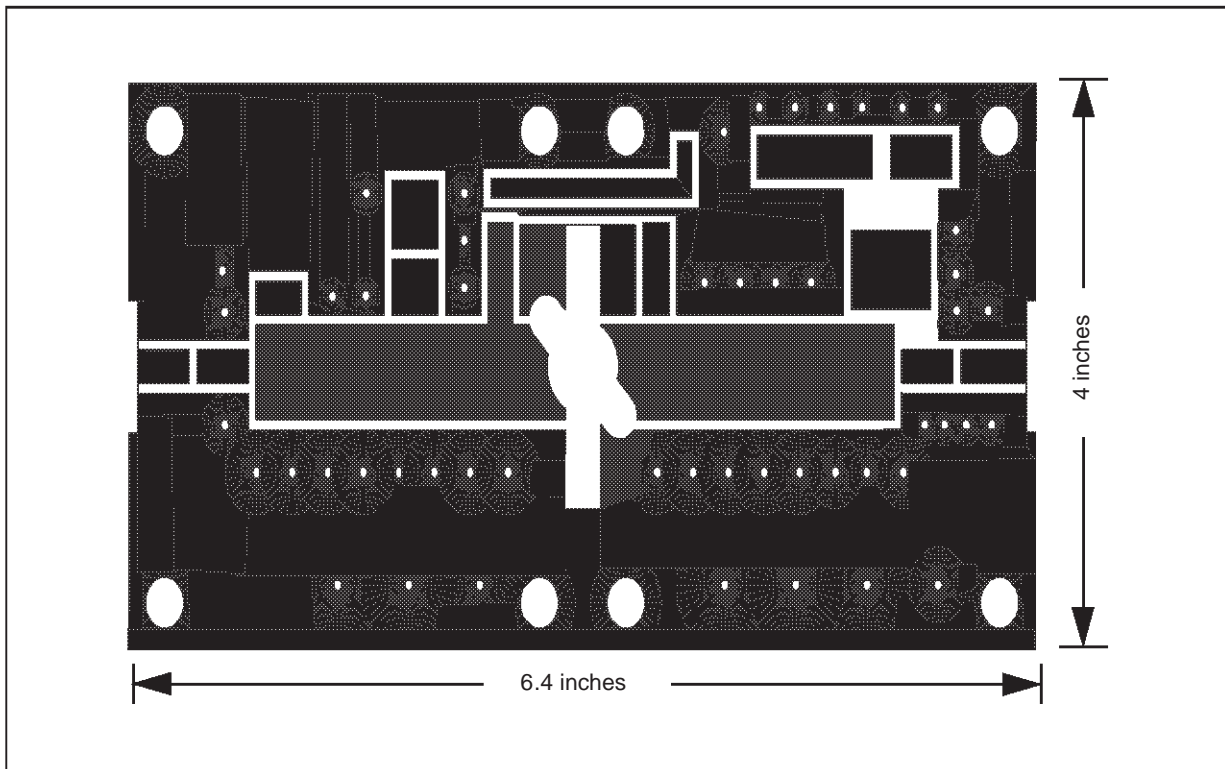

175 MHz Test Circuit

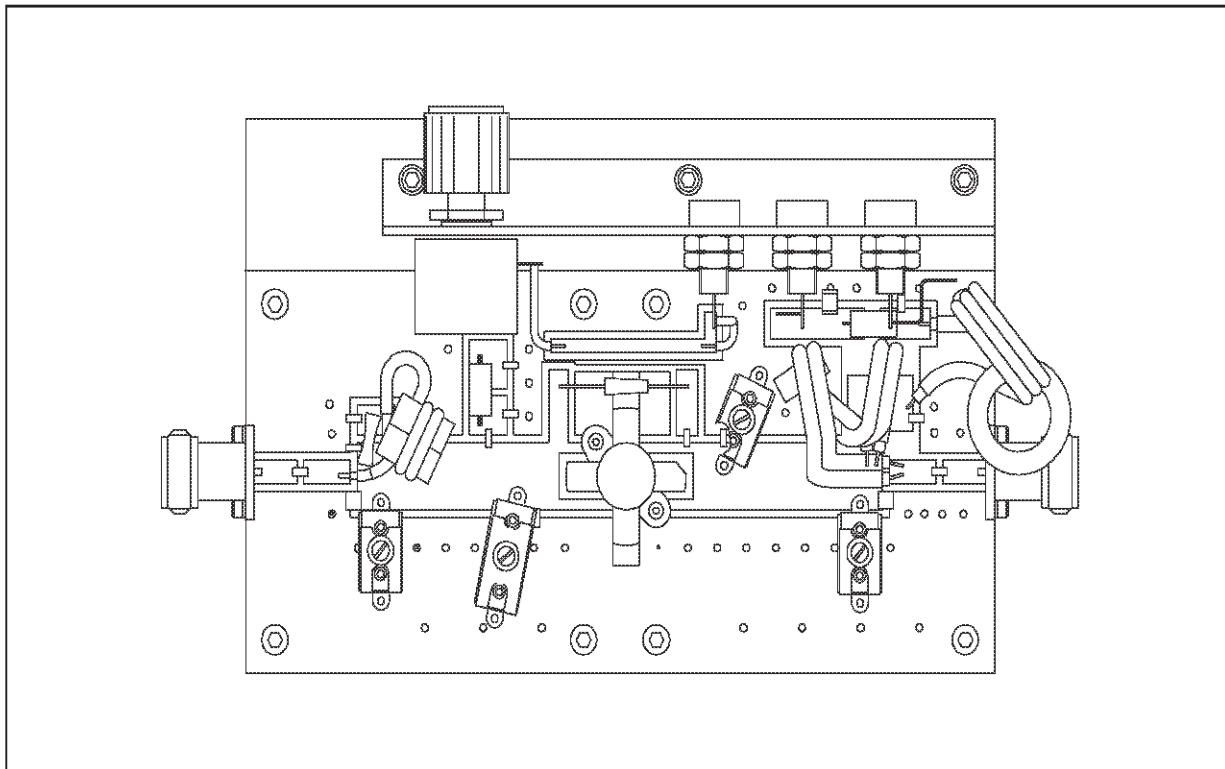

TYPICAL PERFORMANCE (30 MHz)

Output Power vs. Input Power

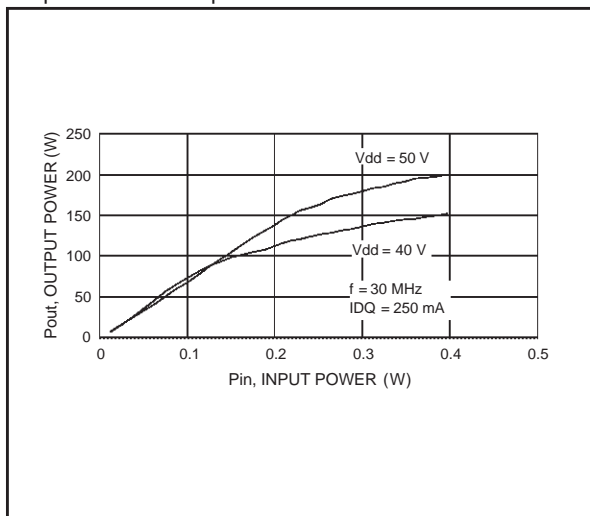

Power Gain vs. Output Power

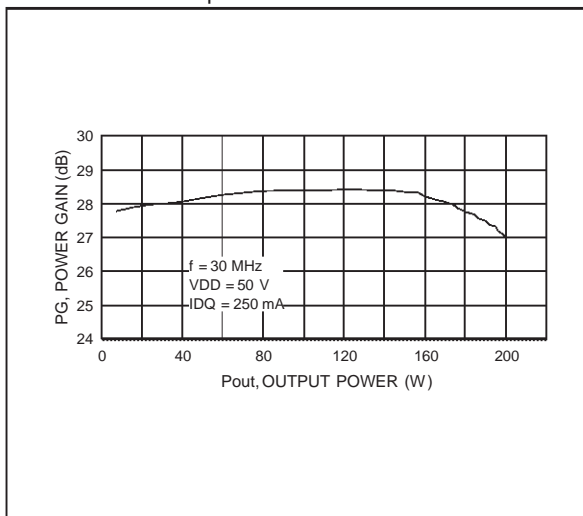

Efficiency vs. Output Power

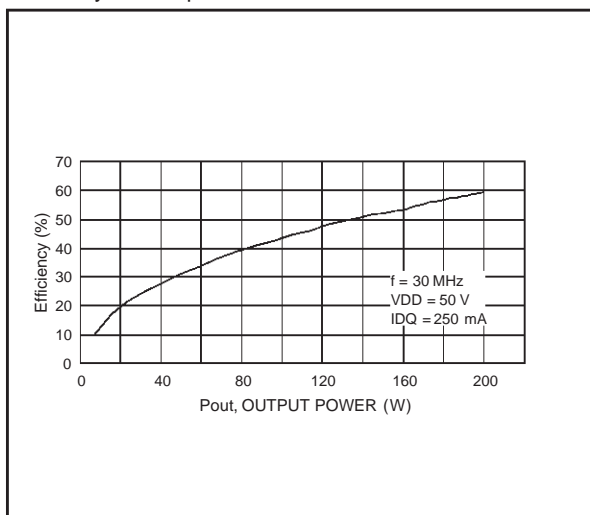

Output Power vs. Supply Voltage

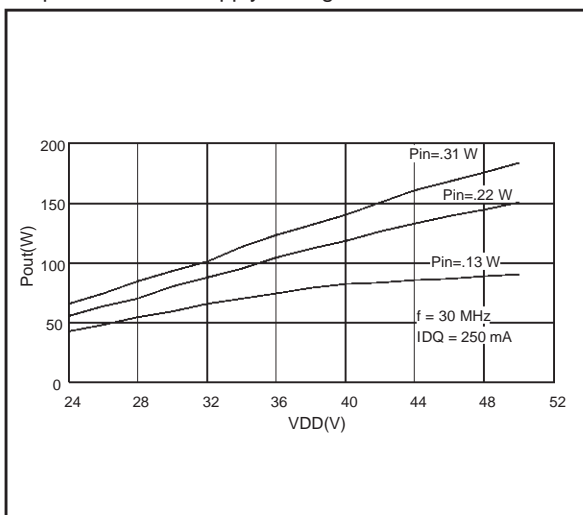

Output Power vs. Gate Voltage

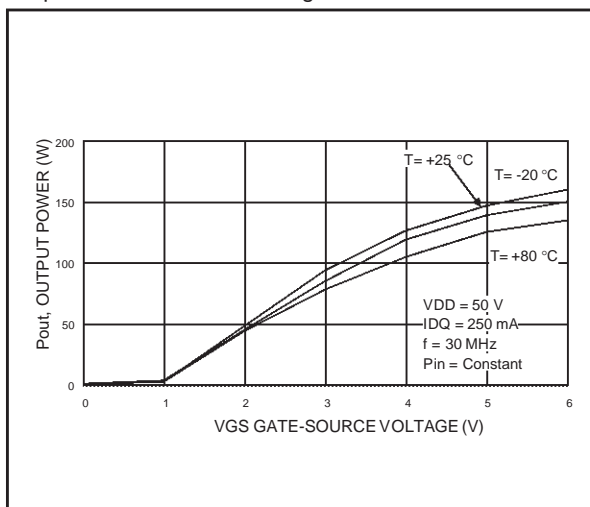

30 MHz Test Circuit Schematic (Engineering Test Circuit)

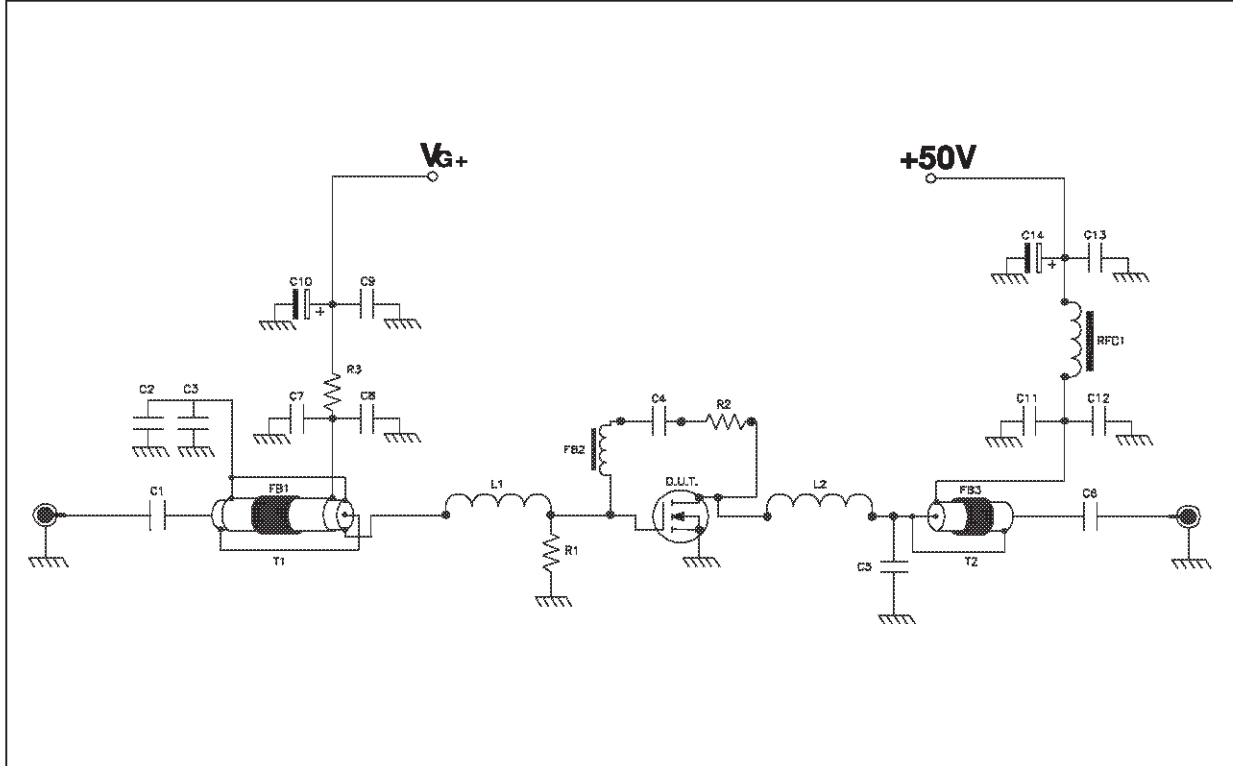

30 MHz Test Circuit Component Part List

T1	9:1 Transformer, 25 ohm Flexible Coax with extra shield .090 OD 15" Long
T2	1:4 Transformer, 50 ohm Flexible Coax .225 OD 15" Long
FB1	Toroid 1.7" OD .30" ID 220μ 4Turns
FB2	Surface Mount EMI Shield Bead
FB3	Toroid 1.7" OD .300" ID 220μ 3Turns
RFC1	Toroid 0.5" OD 0.30" ID 125μ 4Turns 12 awg wire
PCB	0.62" Woven Fiberglass, 1 oz. Copper, 2 Sides, εr = 2.55
R1, R3	1 K ohm 1 W Chip Resistor
R2	680 ohm 3W Wirewound Resistor
C1,C4,C6,C7,C8,C9, C11,C12,C13	0.1 μF ATC Chip Cap
C2,C3	750 pF ATC Chip Cap
C5	470 pF ATC Chip Cap
C10	10 μF 63 V Electrolytic Capacitor
C14	100 μF 63 V Electrolytic Capacitor

M174 (.500 DIA 4/L N/HERM W/FLG) MECHANICAL DATA

DIM.	mm			Inch		
	MIN.	TYP.	MAX	MIN.	TYP.	MAX
A	5.56		5.584	0.219		0.230
B		3.18			0.125	
C	6.22		6.48	0.245		0.255
D	18.28		18.54	0.720		0.730
E		3.18			0.125	
F	24.64		24.89	0.970		0.980
G	12.57		12.83	0.495		0.505
H	0.08		0.18	0.003		0.007
I	2.11		3.00	0.083		0.118
J	3.81		4.45	0.150		0.175
K			7.11			0.280
L	25.53		26.67	1.005		1.050
M	3.05		3.30	0.120		0.130

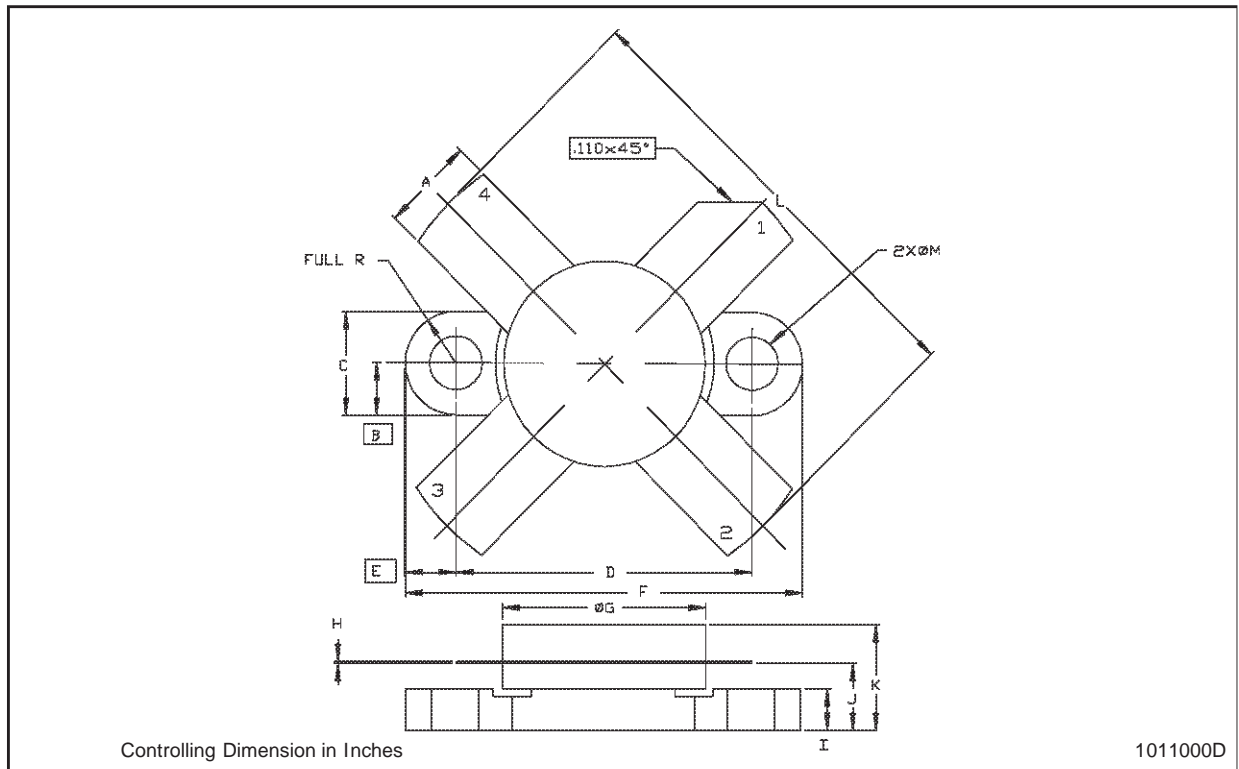

Information furnished is believed to be accurate and reliable. However, STMicroelectronics assumes no responsibility for the consequences of use of such information nor for any infringement of patents or other rights of third parties which may result from its use. No license is granted by implication or otherwise under any patent or patent rights of STMicroelectronics. Specifications mentioned in this publication are subject to change without notice. This publication supersedes and replaces all information previously supplied. STMicroelectronics products are not authorized for use as critical components in life support devices or systems without express written approval of STMicroelectronics.

The ST logo is registered trademark of STMicroelectronics
© 2002 STMicroelectronics - All Rights Reserved

All other names are the property of their respective owners.

STMicroelectronics GROUP OF COMPANIES
Australia - Brazil - Canada - China - Finland - France - Germany - Hong Kong - India - Israel - Italy - Japan -
Malaysia - Malta - Morocco - Singapore - Spain - Sweden - Switzerland - United Kingdom - U.S.A.

<http://www.st.com>