



## TELECOM EQUIPMENT PROTECTION: TRISIL™

### FEATURES

- Bidirectional crowbar protection
- Voltage: 270V
- Low  $V_{BO} / V_R$  ratio
- Micro capacitance 15pF typ @ 50V
- Low leakage current :  $I_R = 2\mu\text{A}$  max
- Holding current:  $I_H = 150$  mA min
- Repetitive peak pulse current :  
 $I_{PP} = 80$  A (10/1000 $\mu\text{s}$ )

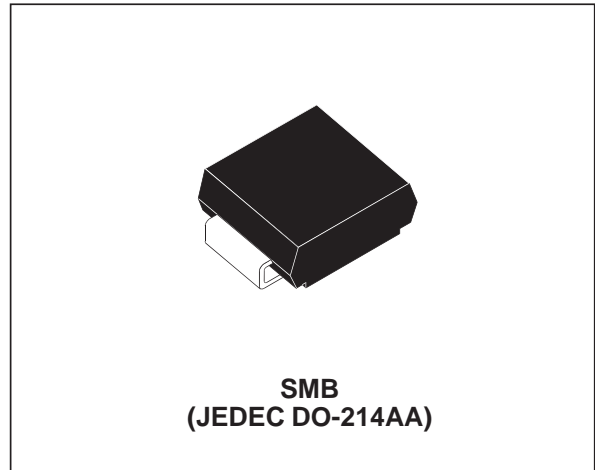
### MAIN APPLICATIONS

Any sensitive equipment requiring protection against lightning strikes and power crossing:

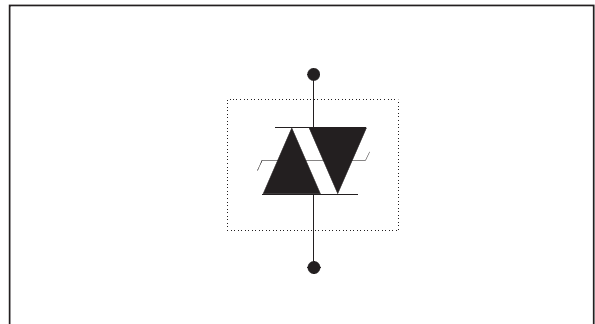
- Analog and digital line cards (xDSL, T1/ E1, ISDN...)
- Terminals (phone, fax, modem...) and central office equipment

### DESCRIPTION

The SMP80MC-270 is a micro capacitance transient surge arrestor designed for the protection of high debit rate communication equipment. Its micro capacitance avoids any distortion of the signal and is compatible with digital line cards (xDSL, T1/E1, ISDN...).



### SCHEMATIC DIAGRAM



### BENEFITS

Trisils are not subject to ageing and provide a fail safe mode in short circuit for a better protection. They are used to help equipment to meet main standards such as UL1950, IEC950 / CSA C22.2 and UL1459. They have UL94 V0 approved resin. SMB package is JEDEC registered (DO-214AA). Trisils are UL497B approved (file: E136224) and comply with the following standards GR-1089 Core, ITU-T-K20/K21, VDE0433, VDE0878, IEC61000-4-5 and FCC part 68.

IN COMPLIANCES WITH THE FOLLOWING STANDARDS

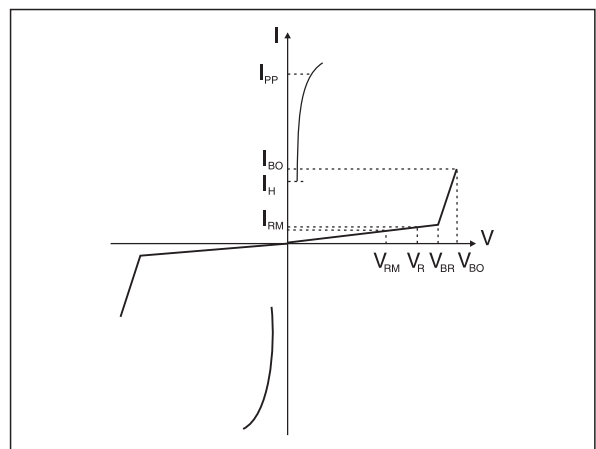
STANDARD	Peak Surge Voltage (V)	Voltage Waveform	Required peak current (A)	Current waveform	Minimum serial resistor to meet standard ( $\Omega$ )
GR-1089 Core First level	2500 1000	2/10 $\mu$ s 10/1000 $\mu$ s	500 100	2/10 $\mu$ s 10/1000 $\mu$ s	5 2.5
GR-1089 Core Second level	5000	2/10 $\mu$ s	500	2/10 $\mu$ s	10
GR-1089 Core Intra-building	1500	2/10 $\mu$ s	100	2/10 $\mu$ s	0
ITU-T-K20/K21	6000 1500	10/700 $\mu$ s	150 37.5	5/310 $\mu$ s	10 0
ITU-T-K20 (IEC61000-4-2)	8000 15000	1/60 ns	ESD contact discharge ESD air discharge		0 0
VDE0433	4000 2000	10/700 $\mu$ s	100 50	5/310 $\mu$ s	0 0
VDE0878	4000 2000	1.2/50 $\mu$ s	100 50	1/20 $\mu$ s	0 0
IEC61000-4-5	4000 4000	10/700 $\mu$ s 1.2/50 $\mu$ s	100 100	5/310 $\mu$ s 8/20 $\mu$ s	0 0
FCC Part 68, lightning surge type A	1500 800	10/160 $\mu$ s 10/560 $\mu$ s	200 100	10/160 $\mu$ s 10/560 $\mu$ s	2.5 0
FCC Part 68, lightning surge type B	1000	9/20 $\mu$ s	25	5/320 $\mu$ s	0

THERMAL RESISTANCES

Symbol	Parameter	Value	Unit
$R_{th(j-a)}$	Junction to ambient with recommended footprint	100	$^{\circ}C/W$
$R_{th(j-l)}$	Junction to leads	20	$^{\circ}C/W$

ELECTRICAL CHARACTERISTICS ( $T_{amb} = 25^{\circ}C$ )

Symbol	Parameter
$V_{RM}$	Stand-off voltage
$I_{RM}$	Leakage current at $V_{RM}$
$V_R$	Continuous reverse voltage
$I_R$	Leakage current at $V_R$
$V_{BR}$	Breakdown voltage
$V_{BO}$	Breakover voltage
$I_H$	Holding current
$I_{BO}$	Breakover current
$I_{PP}$	Peak pulse current
C	Capacitance



**ABSOLUTE RATINGS** ( $T_{amb} = 25^{\circ}\text{C}$ )

Symbol	Parameter	Value	Unit	
$I_{pp}$	Repetitive peak pulse current:	10/1000 $\mu\text{s}$	80	A
		8/20 $\mu\text{s}$	250	
		10/560 $\mu\text{s}$	100	
		5/310 $\mu\text{s}$	120	
		10/160 $\mu\text{s}$	150	
		1/20 $\mu\text{s}$	250	
		2/10 $\mu\text{s}$	250	
		$I_{FS}$	Fail-safe mode : maximum current (note 1)	
$I_{TSM}$	Non repetitive surge peak on-state current (Sinusoidal)	t = 20ms	28	A
		t = 16.6ms	30	
		t = 0.2s	14	
		t = 2s	7	
$I^2t$	$I^2t$ value for fusing	t = 16.6ms	7.5	$\text{A}^2\text{s}$
		t = 20ms	7.8	
$T_L$	Maximum lead temperature for soldering during 10s	260	$^{\circ}\text{C}$	
$T_{stg}$ $T_j$	Storage temperature range	- 55 to + 150	$^{\circ}\text{C}$	
	Maximum junction temperature	150	$^{\circ}\text{C}$	

Note 1: in fail safe mode, the device acts as a short circuit.

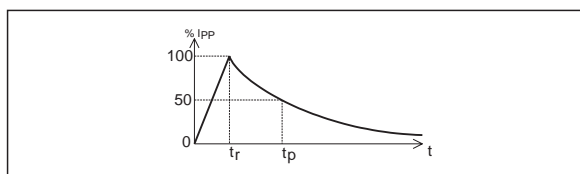
**Repetitive peak pulse current**

$t_r$ : rise time ( $\mu\text{s}$ )

$t_p$ : pulse duration time ( $\mu\text{s}$ )

ex: Pulse waveform 10/1000 $\mu\text{s}$

$t_r = 10\mu\text{s}$   $t_p = 1000\mu\text{s}$

**ELECTRICAL PARAMETERS** ( $T_{amb} = 25^{\circ}\text{C}$ )

Type	$I_{RM} @ V_{RM}$ max.		$I_R @ V_R$ max. Note 1		Dynamic $V_{BO}$ max. Note 2	Static $V_{BO} @ I_{BO}$ max. Note 3		$I_H$ min. Note 4	C typ. Note 5	C typ. Note 6
	$\mu\text{A}$	V	$\mu\text{A}$	V	V	V	mA	mA	pF	pF
SMP80MC-270	2	243	50	270	345	335	800	150	15	30

**Note 1:**  $I_R$  measured at  $V_R$  guarantee  $V_{BR} \min \geq V_R$

**Note 2:** See functional test circuit 1

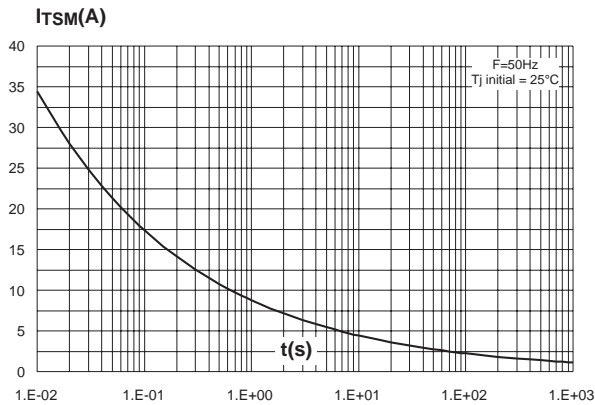
**Note 3:** See test circuit 2

**Note 4:** See functional holding current test circuit 3

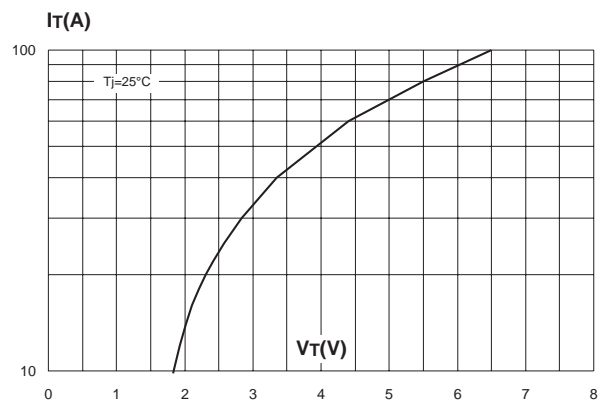
**Note 5:**  $V_R = 50\text{V}$  bias,  $V_{RMS} = 1\text{V}$ ,  $F = 1\text{MHz}$

**Note 6:**  $V_R = 2\text{V}$  bias,  $V_{RMS} = 1\text{V}$ ,  $F = 1\text{MHz}$

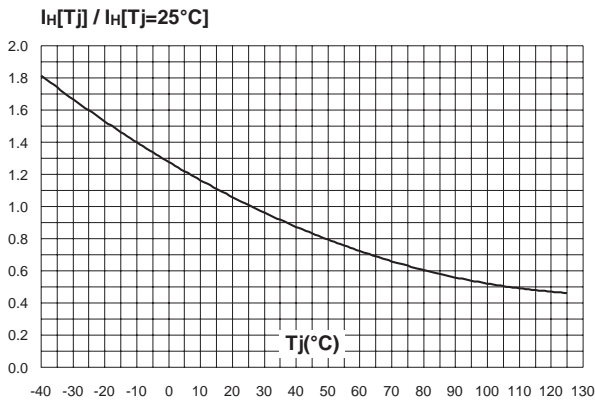
**Fig. 1:** Non repetitive surge peak on-state current versus overload duration.



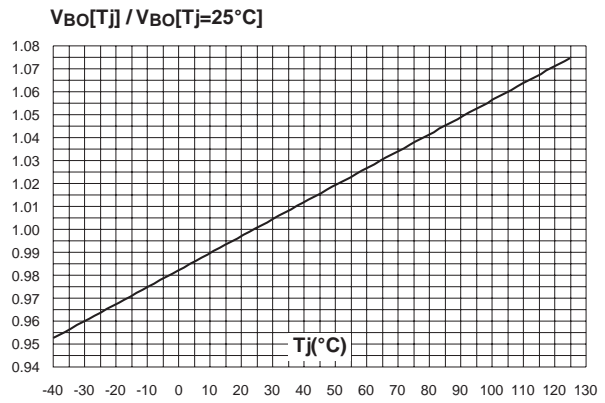
**Fig. 2:** On-state voltage versus on-state current (typical values)



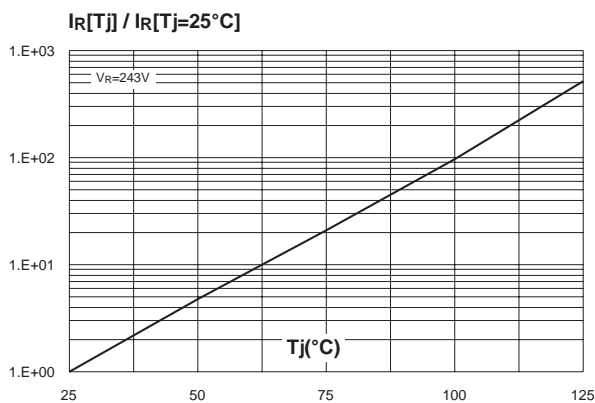
**Fig. 3:** Relative variation of holding current versus junction temperature.



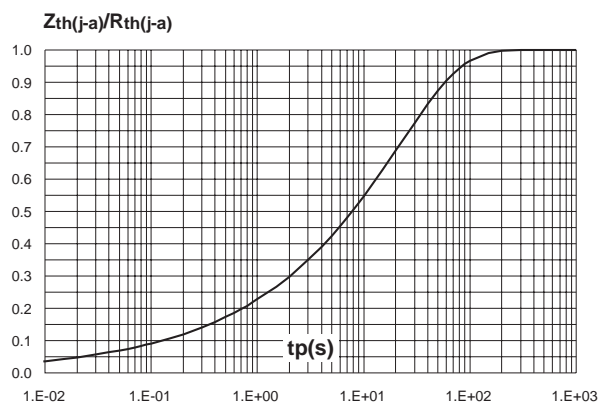
**Fig. 4:** Relative variation of breakover voltage versus junction temperature.



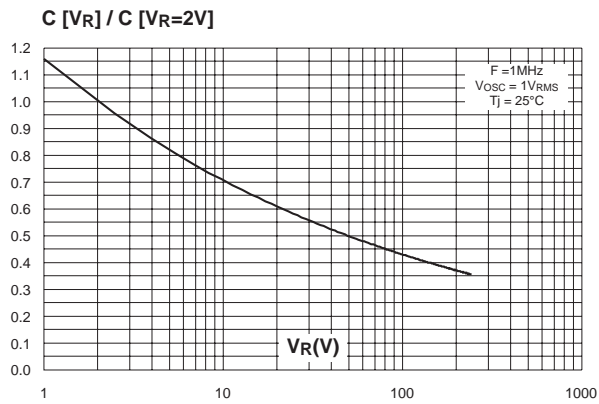
**Fig. 5:** Relative variation of leakage current versus reverse voltage applied (typical values).



**Fig. 6:** Variation of thermal impedance junction to ambient versus pulse duration (Printed circuit board FR4, SCu=35μm, recommended pad layout).

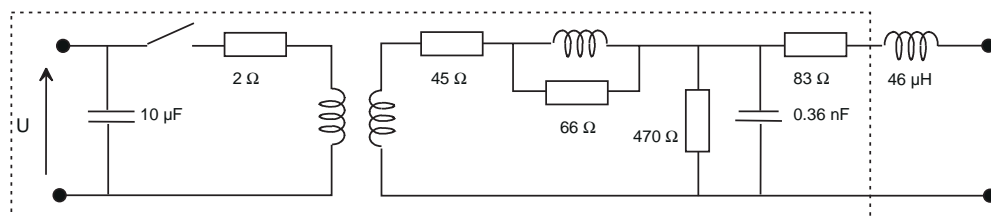


**Fig. 7:** Relative variation of junction capacitance versus reverse voltage applied (typical values).



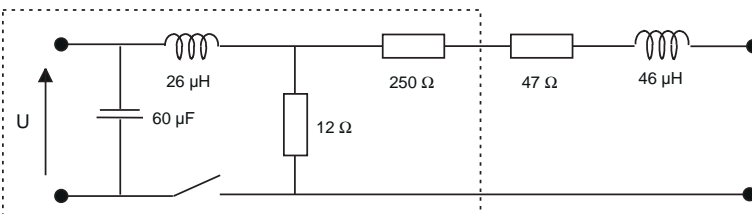
### TEST CIRCUIT 1 FOR DYNAMIC $I_{B0}$ AND $V_{B0}$ PARAMETERS

**100 V /  $\mu\text{s}$ ,  $di/dt < 10\text{ A} / \mu\text{s}$ ,  $I_{pp} = 80\text{ A}$**



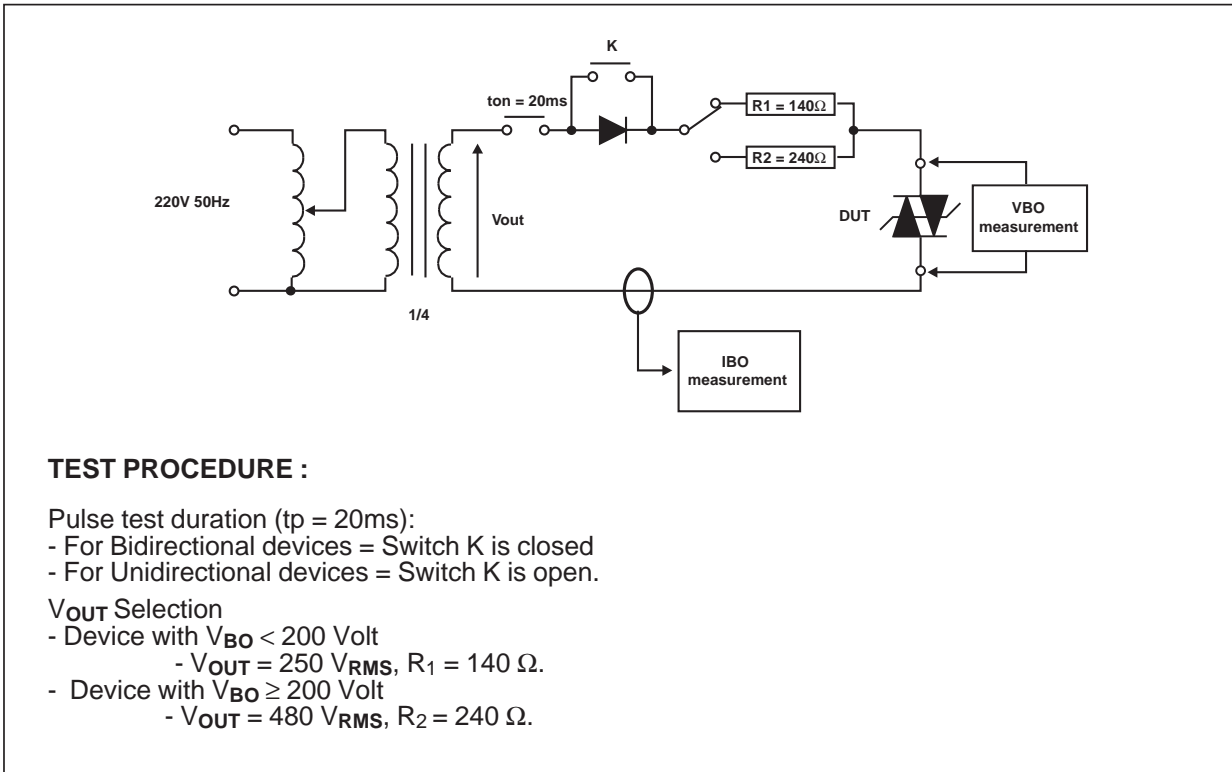
KeyTek 'System 2' generator with PN246I module

**1 kV /  $\mu\text{s}$ ,  $di/dt < 10\text{ A} / \mu\text{s}$ ,  $I_{pp} = 10\text{ A}$**

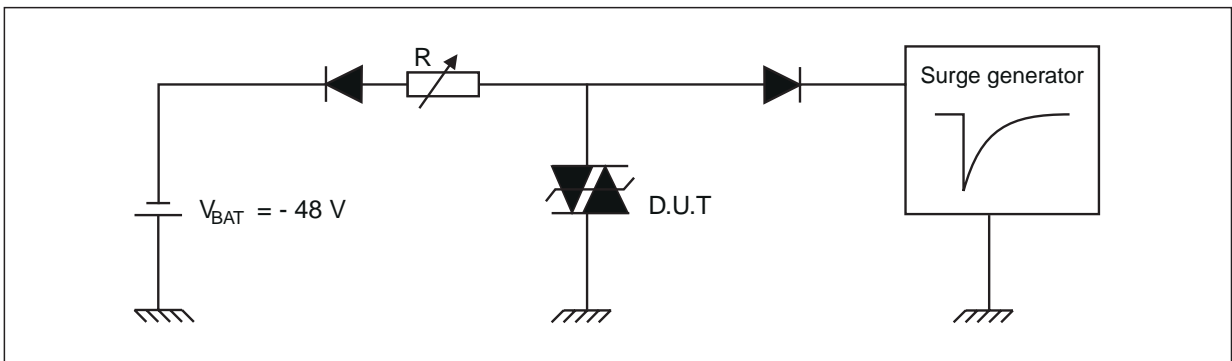


KeyTek 'System 2' generator with PN246I module

**TEST CIRCUIT 2 FOR  $I_{BO}$  and  $V_{BO}$  parameters :**



**TEST CIRCUIT 3 FOR  $I_H$  PARAMETER**

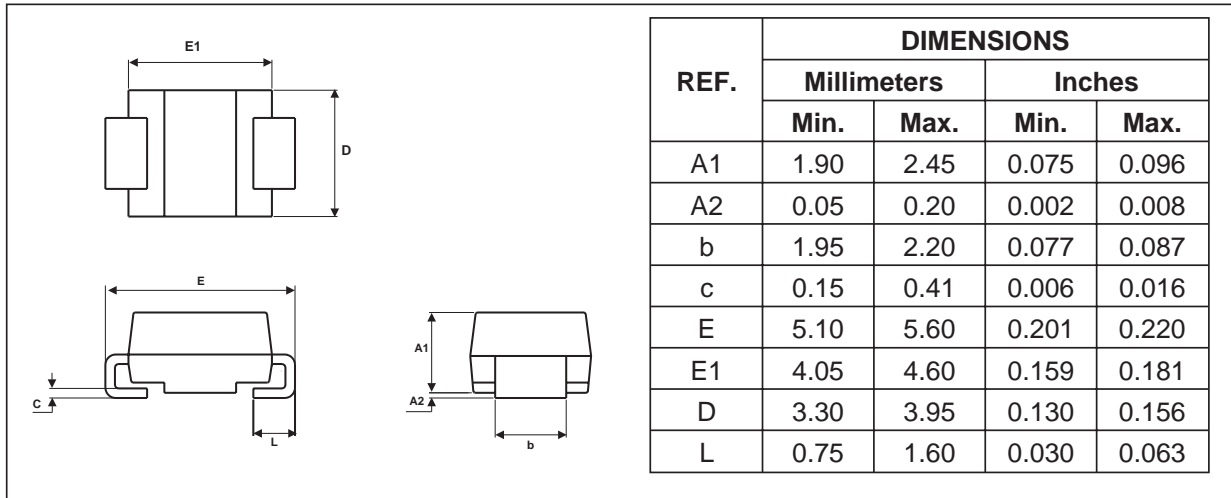


This is a GO-NO GO test which allows to confirm the holding current ( $I_H$ ) level in a functional test circuit.

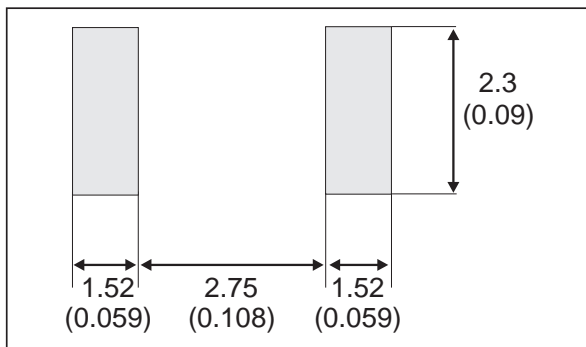
**TEST PROCEDURE :**

- Adjust the current level at the  $I_H$  value by short circuiting the D.U.T.
- Fire the D.U.T. with a surge current :  $I_{pp} = 10A$ ,  $10/1000 \mu s$ .
- The D.U.T. will come back to the off-state within 50 ms max.

**PACKAGE MECHANICAL DATA**  
SMB (Plastic)

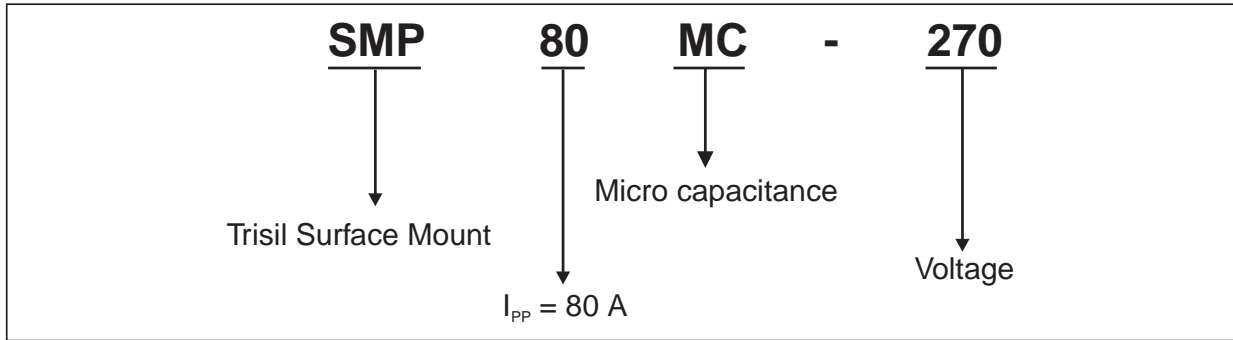


**FOOT PRINT** in millimeters (inches)



# SMP80MC-270

## ORDER CODE



Ordering type	Marking	Package	Weight	Base qty	Delivery mode
SMP80MC-270	TP27	SMB	0.11g	2500	Tape & Reel

Information furnished is believed to be accurate and reliable. However, STMicroelectronics assumes no responsibility for the consequences of use of such information nor for any infringement of patents or other rights of third parties which may result from its use. No license is granted by implication or otherwise under any patent or patent rights of STMicroelectronics. Specifications mentioned in this publication are subject to change without notice. This publication supersedes and replaces all information previously supplied. STMicroelectronics products are not authorized for use as critical components in life support devices or systems without express written approval of STMicroelectronics.

The ST logo is a registered trademark of STMicroelectronics.

All other names are the property of their respective owners.

© 2003 STMicroelectronics - All rights reserved.

STMicroelectronics GROUP OF COMPANIES

Australia - Belgium - Brazil - Canada - China - Czech Republic - Finland - France - Germany -  
 Hong Kong - India - Israel - Italy - Japan - Malaysia - Malta - Morocco - Singapore - Spain -  
 Sweden - Switzerland - United Kingdom - United States

[www.st.com](http://www.st.com)