



STD12NE06L

N - CHANNEL 60V - 0.09Ω - 12A TO-251/TO-252 STripFET™ POWER MOSFET

TYPE	V _{DSS}	R _{DS(on)}	I _D
STD12NE06L	60 V	< 0.12 Ω	12 A

- TYPICAL R_{DS(on)} = 0.09 Ω
- EXCEPTIONAL dv/dt CAPABILITY
- AVALANCHE RUGGED TECHNOLOGY
- 100 % AVALANCHE TESTED
- APPLICATION ORIENTED CHARACTERIZATION
- ADD SUFFIX "T4" FOR ORDERING IN TAPE & REEL

DESCRIPTION

This Power MOSFET is the latest development of STMicroelectronics unique "Single Feature Size™" strip-based process. The resulting transistor shows extremely high packing density for low on-resistance, rugged avalanche characteristics and less critical alignment steps therefore a remarkable manufacturing reproducibility.

APPLICATIONS

- DC MOTOR CONTROL (DISK DRIVES, etc.)
- DC-DC & DC-AC CONVERTERS
- SYNCHRONOUS RECTIFICATION

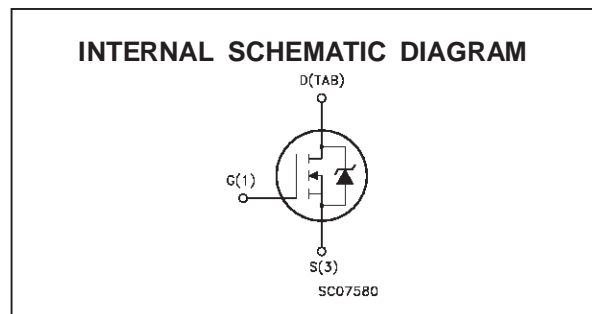
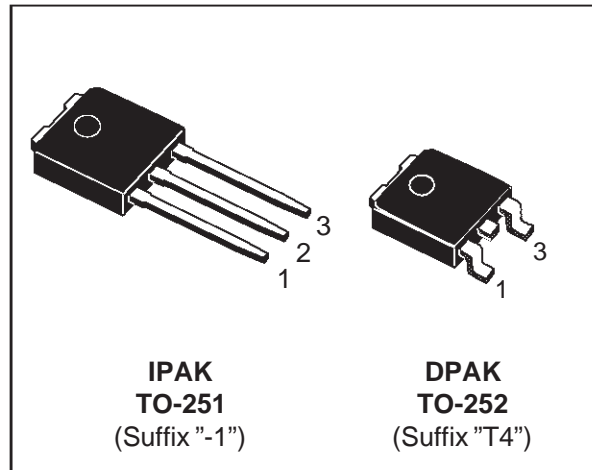

ABSOLUTE MAXIMUM RATINGS

Symbol	Parameter	Value	Unit
V _{DS}	Drain-source Voltage (V _{GS} = 0)	60	V
V _{DGR}	Drain- gate Voltage (R _{GS} = 20 kΩ)	60	V
V _{GS}	Gate-source Voltage	± 20	V
I _D	Drain Current (continuous) at T _c = 25 °C	12	A
I _D	Drain Current (continuous) at T _c = 100 °C	8	A
I _{DM} (•)	Drain Current (pulsed)	48	A
P _{tot}	Total Dissipation at T _c = 25 °C	35	W
	Derating Factor	0.23	W/°C
dv/dt(1)	Peak Diode Recovery voltage slope	6	V/ns
T _{stg}	Storage Temperature	-65 to 175	°C
T _j	Max. Operating Junction Temperature	175	°C

(•) Pulse width limited by safe operating area

(1) I_{SD} ≤ 12 A, di/dt ≤ 200 A/μs, V_{DD} ≤ V_{(BR)DSS}, T_j ≤ T_{JMAX}

STD12NE06L

THERMAL DATA

R _{thj-case}	Thermal Resistance Junction-case	Max	4.3	°C/W
R _{thj-amb}	Thermal Resistance Junction-ambient	Max	100	°C/W
R _{thc-sink}	Thermal Resistance Case-sink	Typ	1.5	°C/W
T _l	Maximum Lead Temperature For Soldering Purpose		275	°C

AVALANCHE CHARACTERISTICS

Symbol	Parameter	Max Value	Unit
I _{AR}	Avalanche Current, Repetitive or Not-Repetitive (pulse width limited by T _j max)	12	A
E _{AS}	Single Pulse Avalanche Energy (starting T _j = 25 °C, I _D = I _{AR} , V _{DD} = 25 V)	45	mJ

ELECTRICAL CHARACTERISTICS (T_{case} = 25 °C unless otherwise specified)

OFF

Symbol	Parameter	Test Conditions	Min.	Typ.	Max.	Unit
V _{(BR)DSS}	Drain-source Breakdown Voltage	I _D = 250 μA V _{GS} = 0	60			V
I _{DSS}	Zero Gate Voltage Drain Current (V _{GS} = 0)	V _{DS} = Max Rating V _{DS} = Max Rating T _c = 100 °C			1 10	μA μA
I _{GSS}	Gate-body Leakage Current (V _{DS} = 0)	V _{GS} = ± 20 V			± 100	nA

ON (*)

Symbol	Parameter	Test Conditions	Min.	Typ.	Max.	Unit
V _{GS(th)}	Gate Threshold Voltage	V _{DS} = V _{GS} I _D = 250 μA	1	1.7	2.5	V
R _{DS(on)}	Static Drain-source On Resistance	V _{GS} = 5V I _D = 6 A V _{GS} = 10V I _D = 6 A		0.09 0.07	0.12 0.10	Ω Ω
I _{D(on)}	On State Drain Current	V _{DS} > I _{D(on)} × R _{DS(on)max} V _{GS} = 10 V	12			A

DYNAMIC

Symbol	Parameter	Test Conditions	Min.	Typ.	Max.	Unit
g _{fs} (*)	Forward Transconductance	V _{DS} > I _{D(on)} × R _{DS(on)max} I _D = 6 A	4	7		S
C _{iss}	Input Capacitance	V _{DS} = 25 V f = 1 MHz V _{GS} = 0		700	1000	pF
C _{oss}	Output Capacitance			100	140	pF
C _{rss}	Reverse Transfer Capacitance			30	45	pF

ELECTRICAL CHARACTERISTICS (continued)

SWITCHING ON

Symbol	Parameter	Test Conditions	Min.	Typ.	Max.	Unit
$t_{d(on)}$	Turn-on Time	$V_{DD} = 30\text{ V}$ $I_D = 8\text{ A}$		17	25	ns
t_r	Rise Time	$R_G = 4.7\ \Omega$ $V_{GS} = 5\text{ V}$ (see test circuit, figure 3)		38	50	ns
Q_g	Total Gate Charge	$V_{DD} = 48\text{ V}$ $I_D = 16\text{ A}$ $V_{GS} = 5\text{ V}$		12	16	nC
Q_{gs}	Gate-Source Charge			6		nC
Q_{gd}	Gate-Drain Charge			6		nC

SWITCHING OFF

Symbol	Parameter	Test Conditions	Min.	Typ.	Max.	Unit
$t_{r(Voff)}$	Off-voltage Rise Time	$V_{DD} = 48\text{ V}$ $I_D = 16\text{ A}$		9	12	ns
t_f	Fall Time	$R_G = 4.7\ \Omega$ $V_{GS} = 5\text{ V}$		18	25	ns
t_c	Cross-over Time	(see test circuit, figure 5)		30	45	ns

SOURCE DRAIN DIODE

Symbol	Parameter	Test Conditions	Min.	Typ.	Max.	Unit
I_{SD}	Source-drain Current				12	A
$I_{SDM}(\bullet)$	Source-drain Current (pulsed)				48	A
$V_{SD}(\ast)$	Forward On Voltage	$I_{SD} = 12\text{ A}$ $V_{GS} = 0$			1.5	V
t_{rr}	Reverse Recovery Time	$I_{SD} = 16\text{ A}$ $di/dt = 100\text{ A}/\mu\text{s}$ $V_{DD} = 25\text{ V}$ $T_j = 150\text{ }^\circ\text{C}$ (see test circuit, figure 5)		70		ns
Q_{rr}	Reverse Recovery Charge			0.13		μC
I_{RRM}	Reverse Recovery Current			4		A

(*) Pulsed: Pulse duration = 300 μs , duty cycle 1.5 %

(•) Pulse width limited by safe operating area

Safe Operating Area for

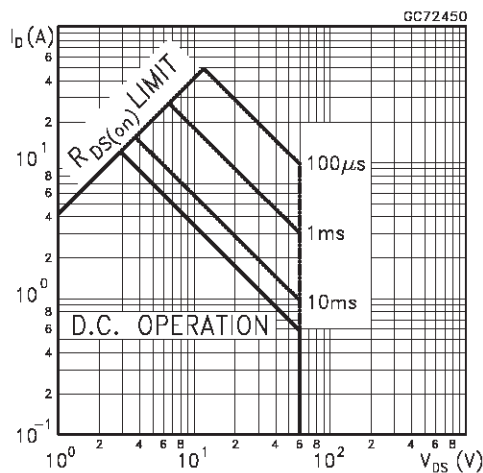

Thermal Impedance

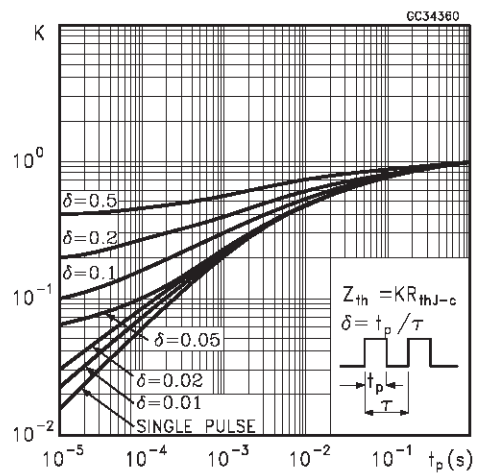

Output Characteristics

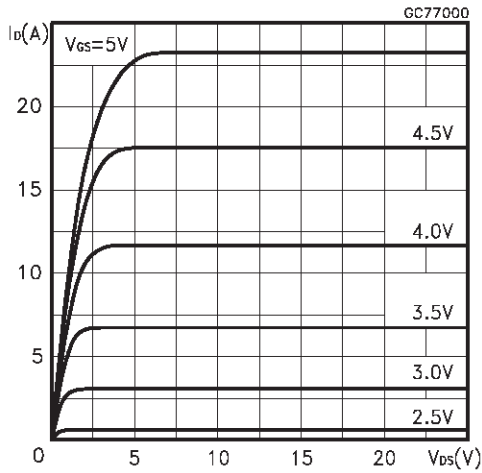

Transfer Characteristics

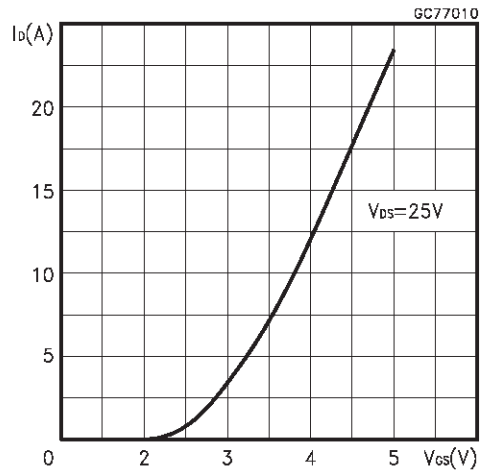

Transconductance

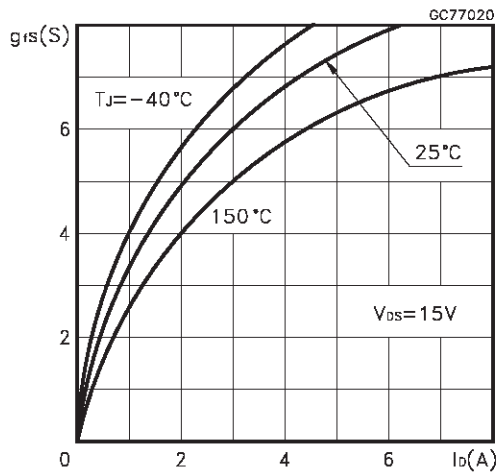

Static Drain-source On Resistance

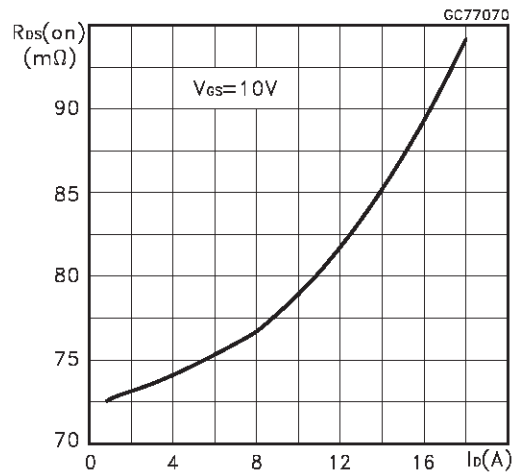

Gate Charge vs Gate-source Voltage

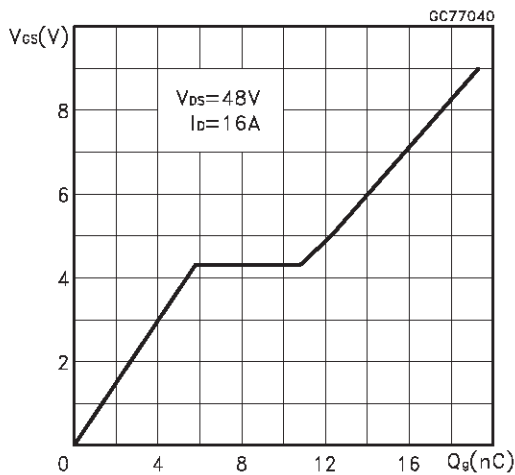

Capacitance Variations

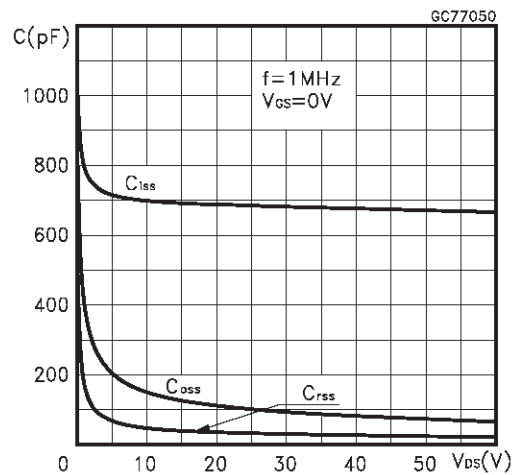

Normalized Gate Threshold Voltage vs Temperature

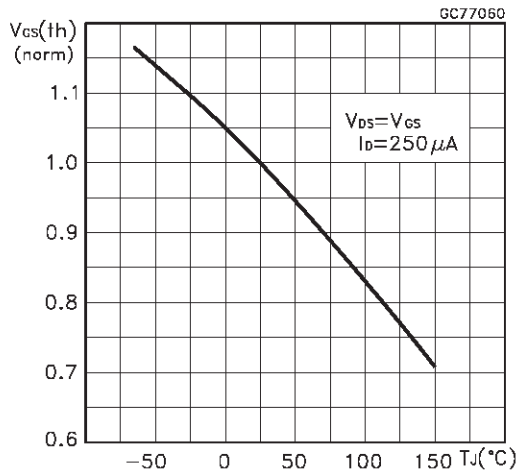

Normalized On Resistance vs Temperature

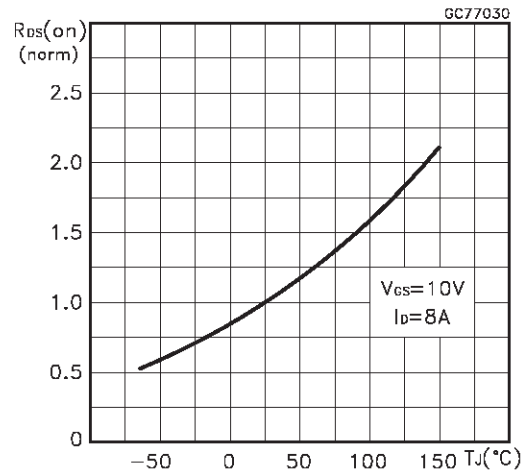

Source-drain Diode Forward Characteristics

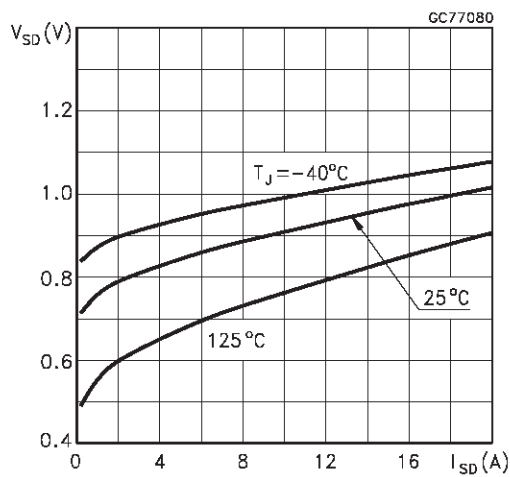

Fig. 1: Unclamped Inductive Load Test Circuit



Fig. 2: Unclamped Inductive Waveform



Fig. 3: Switching Times Test Circuits For Resistive Load



Fig. 4: Gate Charge test Circuit

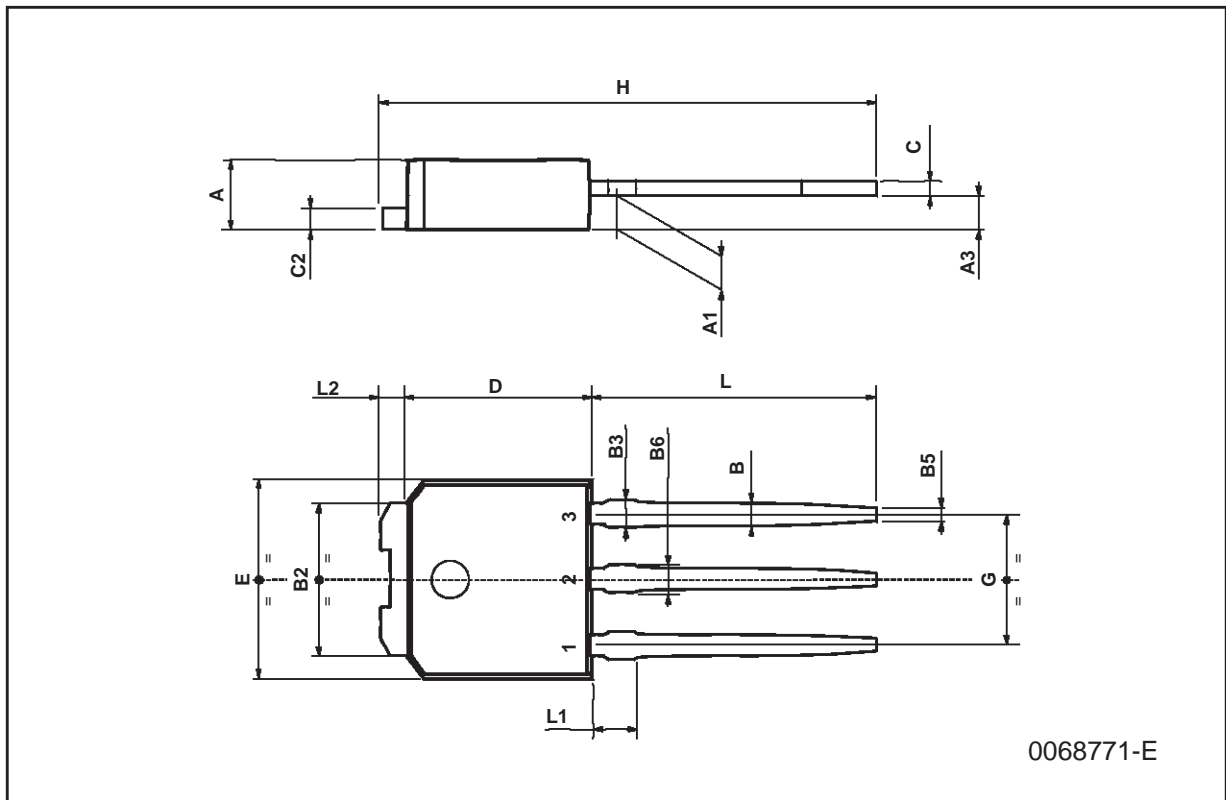

Fig. 5: Test Circuit For Inductive Load Switching And Diode Recovery Times



TO-251 (IPAK) MECHANICAL DATA

DIM.	mm			inch		
	MIN.	TYP.	MAX.	MIN.	TYP.	MAX.
A	2.2		2.4	0.086		0.094
A1	0.9		1.1	0.035		0.043
A3	0.7		1.3	0.027		0.051
B	0.64		0.9	0.025		0.031
B2	5.2		5.4	0.204		0.212
B3			0.85			0.033
B5		0.3			0.012	
B6			0.95			0.037
C	0.45		0.6	0.017		0.023
C2	0.48		0.6	0.019		0.023
D	6		6.2	0.236		0.244
E	6.4		6.6	0.252		0.260
G	4.4		4.6	0.173		0.181
H	15.9		16.3	0.626		0.641
L	9		9.4	0.354		0.370
L1	0.8		1.2	0.031		0.047
L2		0.8	1		0.031	0.039



TO-252 (DPAK) MECHANICAL DATA

DIM.	mm			inch		
	MIN.	TYP.	MAX.	MIN.	TYP.	MAX.
A	2.2		2.4	0.086		0.094
A1	0.9		1.1	0.035		0.043
A2	0.03		0.23	0.001		0.009
B	0.64		0.9	0.025		0.035
B2	5.2		5.4	0.204		0.212
C	0.45		0.6	0.017		0.023
C2	0.48		0.6	0.019		0.023
D	6		6.2	0.236		0.244
E	6.4		6.6	0.252		0.260
G	4.4		4.6	0.173		0.181
H	9.35		10.1	0.368		0.397
L2		0.8			0.031	
L4	0.6		1	0.023		0.039

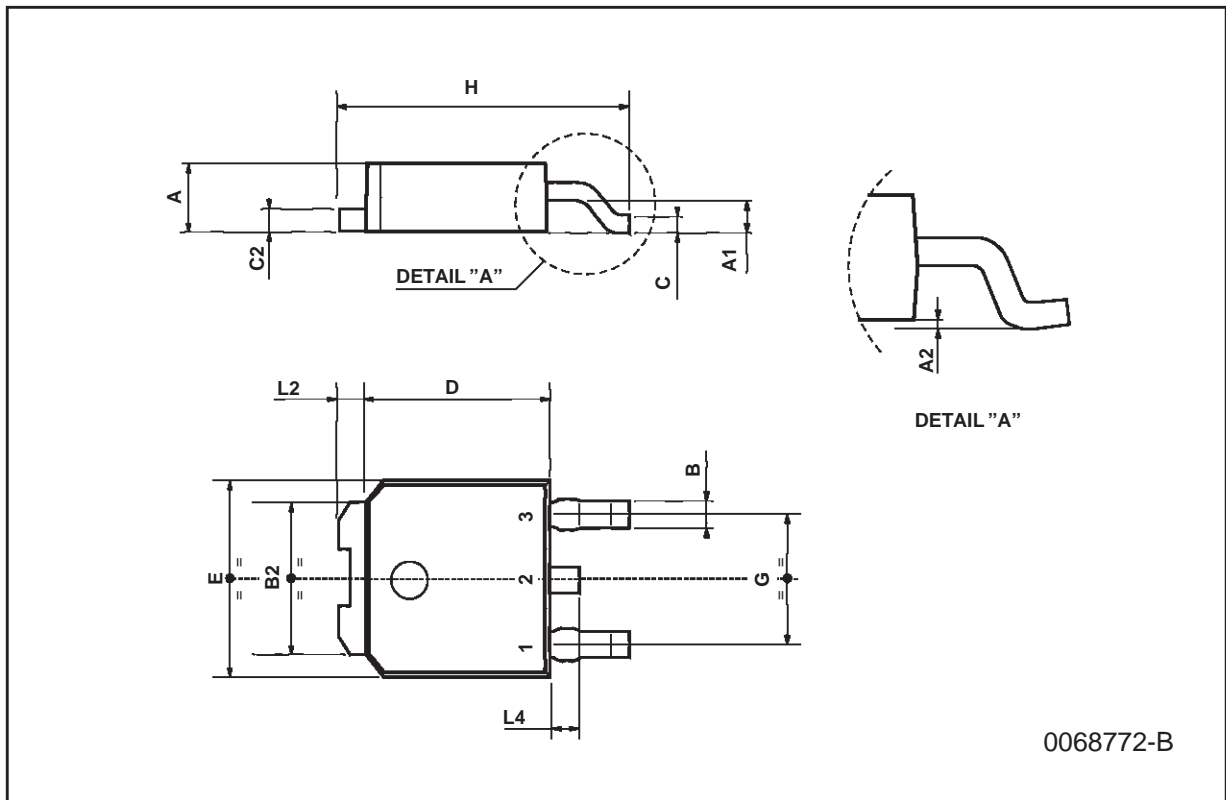

Information furnished is believed to be accurate and reliable. However, STMicroelectronics assumes no responsibility for the consequences of use of such information nor for any infringement of patents or other rights of third parties which may result from its use. No license is granted by implication or otherwise under any patent or patent rights of STMicroelectronics. Specification mentioned in this publication are subject to change without notice. This publication supersedes and replaces all information previously supplied. STMicroelectronics products are not authorized for use as critical components in life support devices or systems without express written approval of STMicroelectronics.

The ST logo is a trademark of STMicroelectronics

© 1999 STMicroelectronics – Printed in Italy – All Rights Reserved
STMicroelectronics GROUP OF COMPANIES

Australia - Brazil - China - Finland - France - Germany - Hong Kong - India - Italy - Japan - Malaysia - Malta - Morocco -
Singapore - Spain - Sweden - Switzerland - United Kingdom - U.S.A.

<http://www.st.com>

