



ULTRA-FAST RECOVERY RECTIFIER DIODES

MAIN PRODUCTS CHARACTERISTICS

$I_{F(AV)}$	15 A
V_{RRM}	200 V
T_j (max)	150°C
V_F (max)	0.99 V
t_{rr} (max)	30 ns

FEATURES

- SUITED FOR SMPS
- LOW LOSSES
- LOW FORWARD AND REVERSE RECOVERY TIME
- HIGH SURGE CURRENT CAPABILITY
- HIGH AVALANCHE ENERGY CAPABILITY

DESCRIPTION

Low cost single chip rectifier suited for switchmode power supply and high frequency DC to DC converters.

Packaged in TO-220AC and ISOWATT220AC, this device is intended for use in low voltage, high frequency inverters, free wheeling and polarity protection applications.

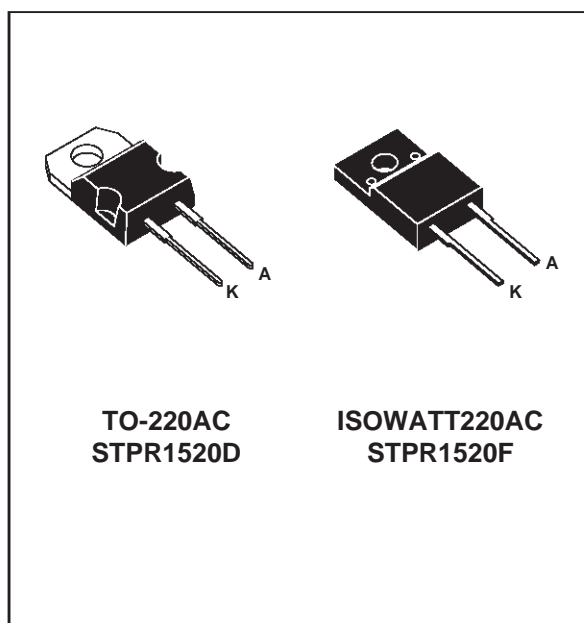

Symbol	Parameter		Value	Unit
V_{RRM}	Repetitive peak reverse voltage		200	V
$I_{F(RMS)}$	RMS forward current		30	A
$I_{F(AV)}$	Average forward current $\delta = 0.5$	TO-220AC	15	A
		ISOWATT220AC		
I_{FSM}	Surge non repetitive forward current		150	A
T_{stg}	Storage temperature range		- 65 to + 150	°C
T_j	Maximum operating junction temperature		+ 150	

STPR1520D/F

THERMAL RESISTANCES

Symbol	Parameter		Value	Unit
$R_{th(j-c)}$	Junction to case	TO-220AC	2	°C/W
		ISOWATT220AC	4.5	

STATIC ELECTRICAL CHARACTERISTICS

Symbol	Parameters	Test conditions		Min.	Typ.	Max.	Unit
I_R^*	Reverse leakage current	$T_j = 25^\circ\text{C}$	$V_R = V_{RRM}$			50	μA
		$T_j = 100^\circ\text{C}$				1	mA
V_F^{**}	Forward voltage drop	$T_j = 125^\circ\text{C}$	$I_F = 15\text{ A}$			0.99	V
		$T_j = 125^\circ\text{C}$	$I_F = 30\text{ A}$			1.20	
		$T_j = 25^\circ\text{C}$	$I_F = 30\text{ A}$			1.25	

Pulse test : * $t_p = 5\text{ ms}$, $\delta < 2\%$
 ** $t_p = 380\text{ }\mu\text{s}$, $\delta < 2\%$

To evaluate the conduction losses use the following equation :
 $P = 0.78 \times I_{F(AV)} + 0.014 \times I_F^2(RMS)$

RECOVERY CHARACTERISTICS

Symbol	Test conditions			Min.	Typ.	Max.	Unit
t_{rr}	$T_j = 25^\circ\text{C}$	$I_F = 0.5\text{ A}$	$I_{rr} = 0.25\text{ A}$ $I_R = 1\text{ A}$			30	ns
t_{fr}	$T_j = 25^\circ\text{C}$	$I_F = 1\text{ A}$	$t_r = 10\text{ ns}$ $V_{FR} = 1.1 \times V_F$		20		
V_{FP}	$T_j = 25^\circ\text{C}$	$I_F = 1\text{ A}$	$t_r = 10\text{ ns}$		3		V

Fig. 1: Average forward power dissipation versus average forward current.

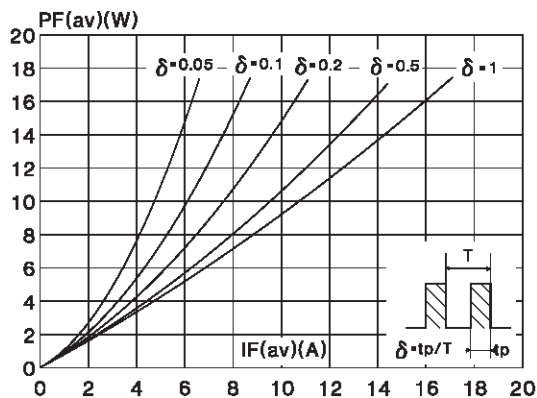

Fig. 2: Peak current versus form factor.

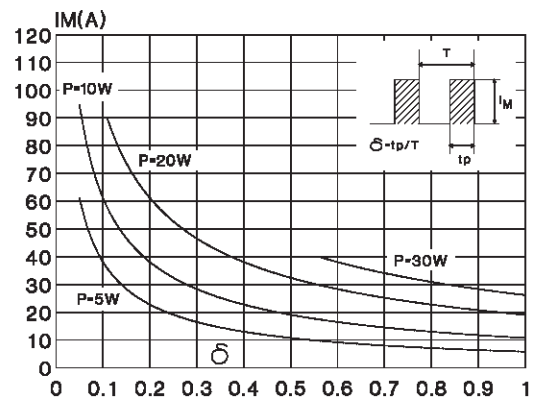

Fig. 3: Average current versus ambient temperature.

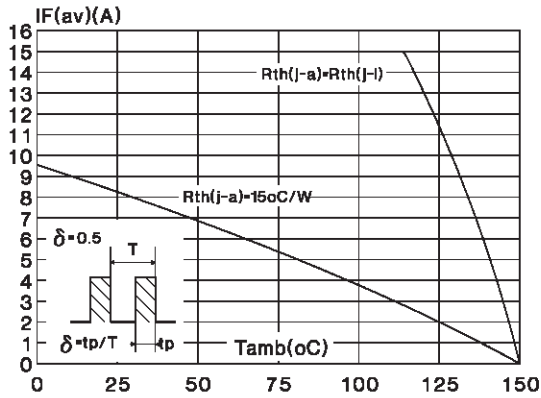

Fig. 4: Average current versus ambient temperature.

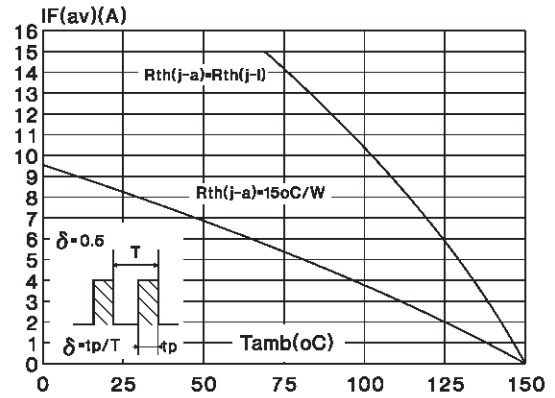

Fig. 5: Non repetitive surge peak forward current versus overload duration (maximum values) (TO-220AC)

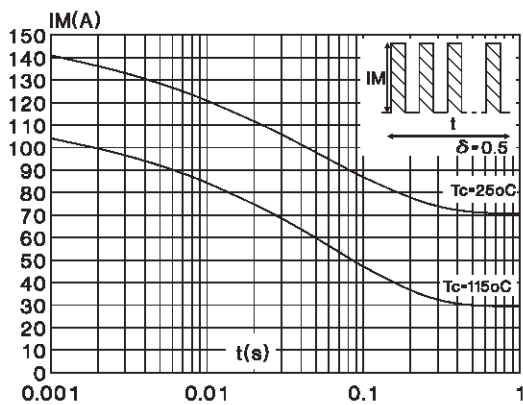

Fig. 6: Non repetitive surge peak forward current versus overload duration (maximum values) (ISOWATT220AC).

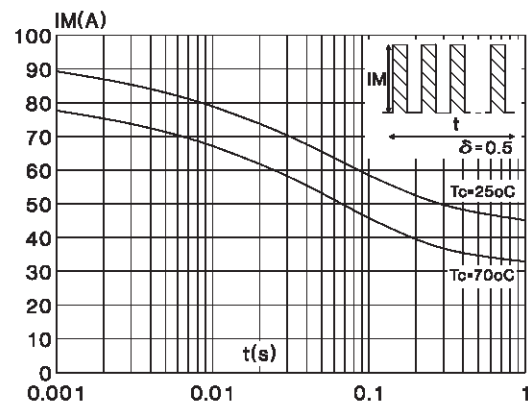

Fig. 7: Relative variation of thermal transient impedance junction to case versus pulse duration (TO-220AC).

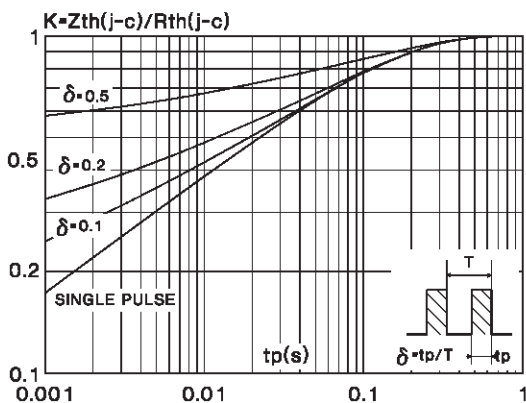
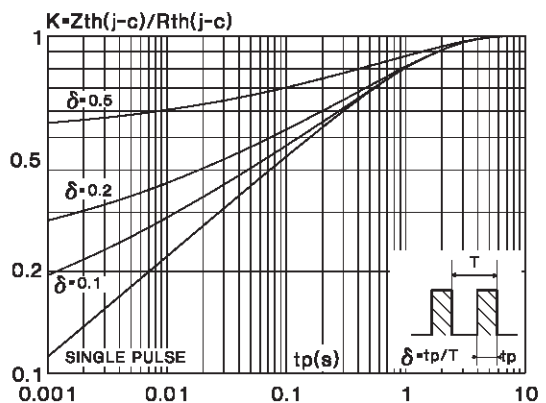

Fig. 8: Relative variation of thermal transient impedance junction to case versus pulse duration (ISOWATT220AC).



STPR1520D/F

Fig. 9: Forward voltage drop versus forward current.

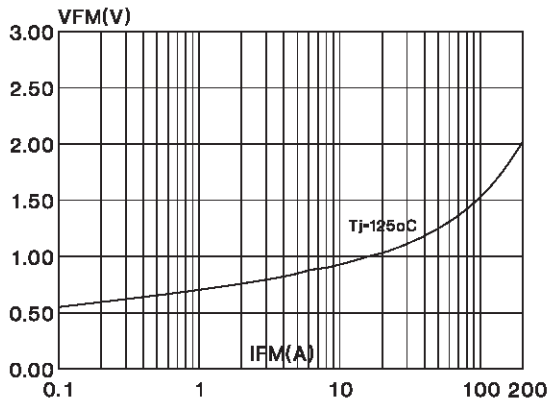

Fig. 10: Junction capacitance versus reverse voltage applied (typical values).

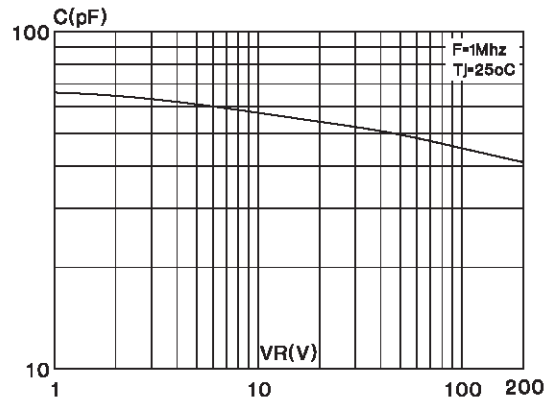

Fig. 11: Recovery charge versus dI_F/dt .

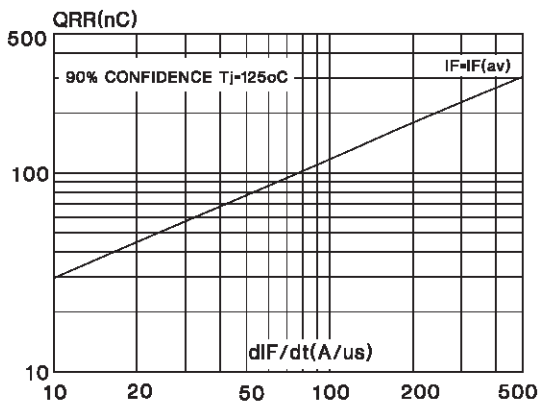

Fig. 12: Peak reverse current versus dI_F/dt .

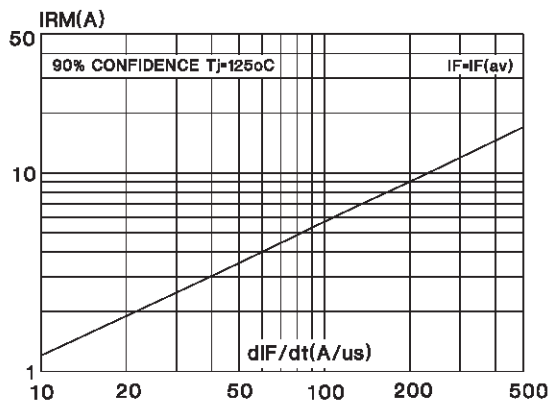
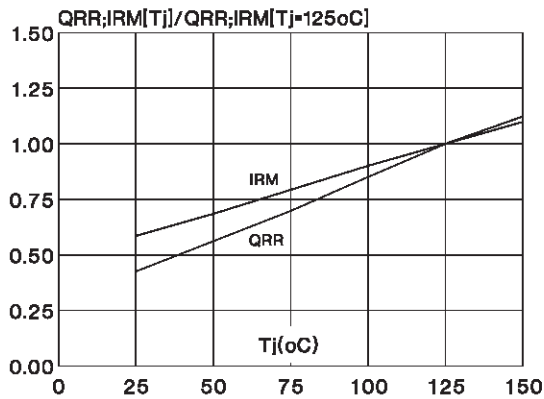
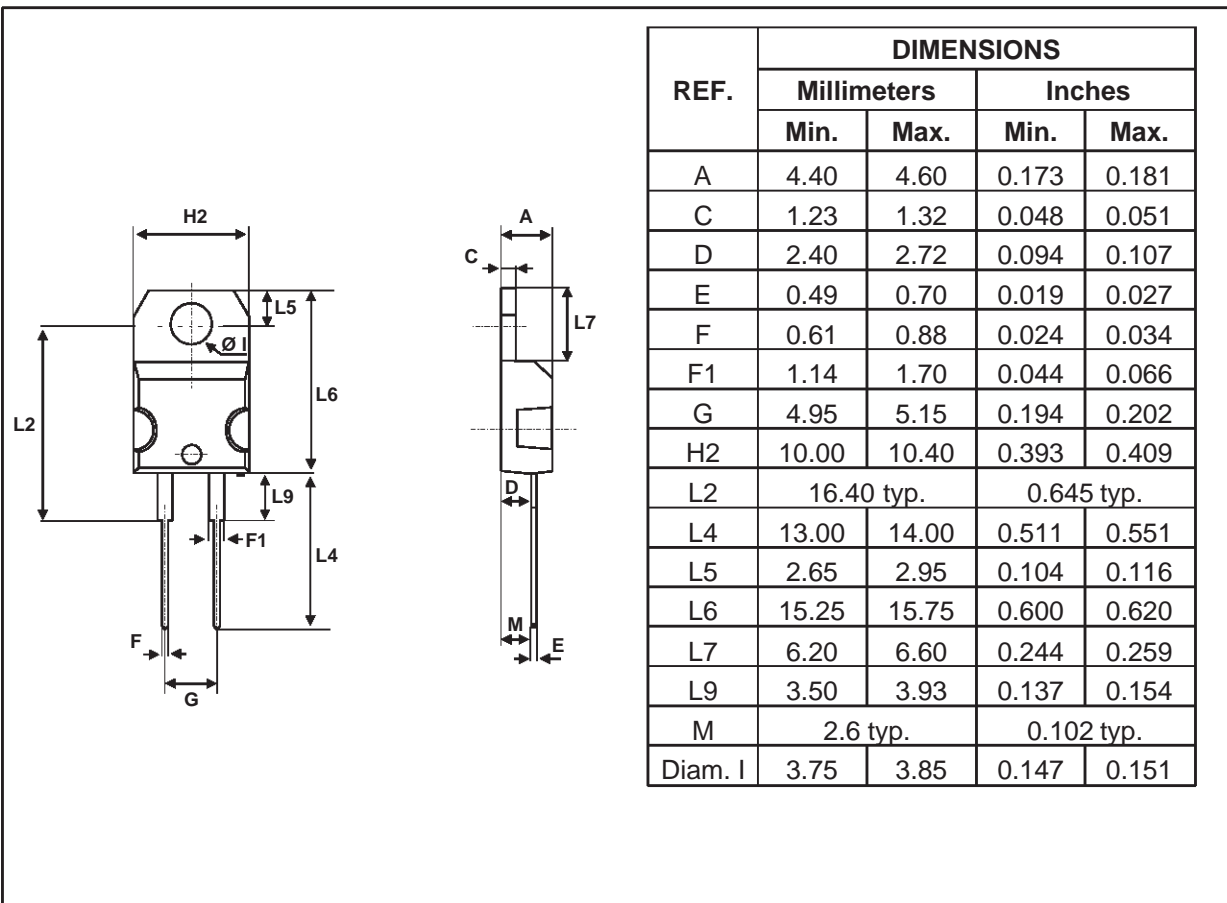

Fig. 13: Dynamic parameters versus junction temperature.



PACKAGE MECHANICAL DATA

TO-220AC



STPR1520D/F

PACKAGE MECHANICAL DATA
ISOWATT220AC

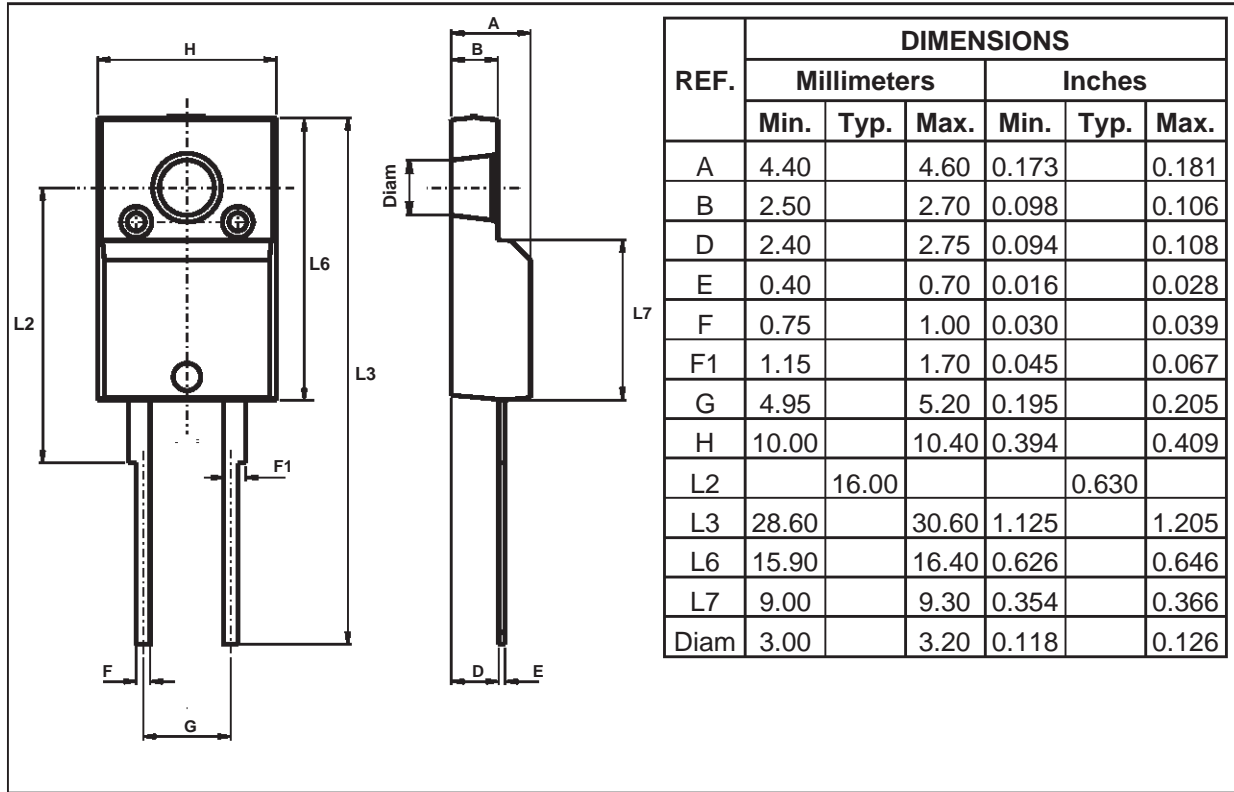

Information furnished is believed to be accurate and reliable. However, STMicroelectronics assumes no responsibility for the consequences of use of such information nor for any infringement of patents or other rights of third parties which may result from its use. No license is granted by implication or otherwise under any patent or patent rights of STMicroelectronics. Specifications mentioned in this publication are subject to change without notice. This publication supersedes and replaces all information previously supplied. STMicroelectronics products are not authorized for use as critical components in life support devices or systems without express written approval of STMicroelectronics.

The ST logo is a registered trademark of STMicroelectronics
 © 2001 STMicroelectronics - Printed in Italy - All rights reserved.
 STMicroelectronics GROUP OF COMPANIES
 Australia - Brazil - Canada - China - Finland - France - Germany
 Hong Kong - India - Israel - Italy - Japan - Malaysia -Malta - Morocco - Singapore
 Spain - Sweden - Switzerland - United Kingdom - United States.

<http://www.st.com>

