

LOW DROP POWER SCHOTTKY RECTIFIER

MAIN PRODUCT CHARACTERISTICS

$I_{F(AV)}$	2 x 15 A
V_{RRM}	30 V
$T_j(\text{max})$	150 °C
$V_F(\text{max})$	0.37 V

FEATURES AND BENEFITS

- VERY SMALL CONDUCTION LOSSES
- NEGLIGIBLE SWITCHING LOSSES
- EXTREMELY FAST SWITCHING
- LOW FORWARD VOLTAGE DROP
- LOW THERMAL RESISTANCE

DESCRIPTION

Dual center tap Schottky rectifiers suited for Switch Mode Power Supply and high frequency DC to DC converters.

Packaged in TO-220AB and D²PAK these devices are intended for use in low voltage, high frequency inverters, free-wheeling and polarity protection applications.

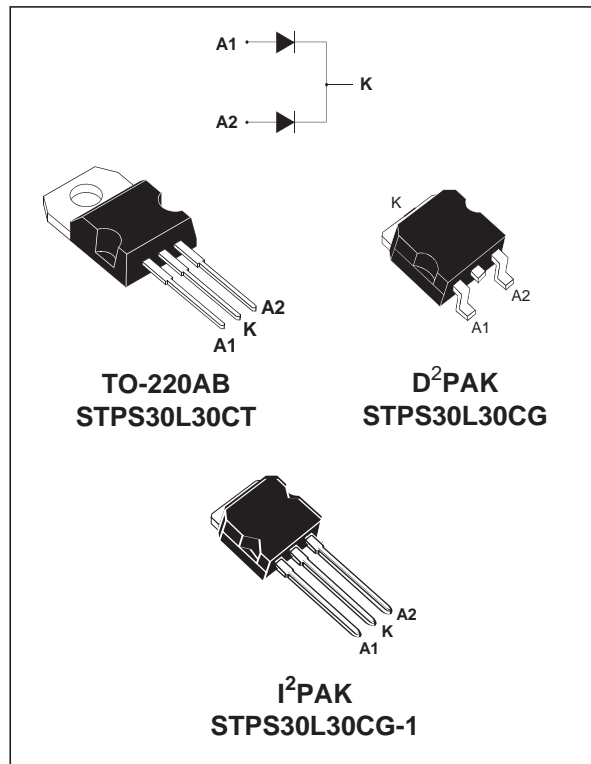

ABSOLUTE RATINGS (limiting values, per diode)

Symbol	Parameter		Value	Unit
V_{RRM}	Repetitive peak reverse voltage		30	V
$I_{F(RMS)}$	RMS forward current		30	A
$I_{F(AV)}$	Average forward current	$T_c = 140^\circ\text{C}$ $\delta = 0.5$	Per diode 15 Per device 30	A
I_{FSM}	Surge non repetitive forward current	$t_p = 10 \text{ ms}$ Sinusoidal	220	A
I_{RRM}	Peak repetitive reverse current	$t_p = 2 \mu\text{s}$ $F = 1 \text{ kHz}$ square	1	A
I_{RSM}	Non repetitive peak reverse current	$t_p = 100 \mu\text{s}$ square	3	A
T_{stg}	Storage temperature range		- 65 to + 150	°C
T_j	Maximum operating junction temperature *		150	°C
dV/dt	Critical rate of rise reverse voltage		10000	V/ μs

* : $\frac{dP_{tot}}{dT_j} < \frac{1}{R_{th(j-a)}}$ thermal runaway condition for a diode on its own heatsink

STPS30L30CT/CG/CG-1

THERMAL RESISTANCE

Symbol	Parameter		Value	Unit
$R_{th(j-c)}$	Junction to case	Per diode	1.5	$^{\circ}\text{C/W}$
		Total	0.8	
$R_{th(c)}$		Coupling	0.1	$^{\circ}\text{C/W}$

When the diodes 1 and 2 are used simultaneously :
 $\Delta T_j(\text{diode } 1) = P(\text{diode } 1) \times R_{th(j-c)}(\text{Per diode}) + P(\text{diode } 2) \times R_{th(c)}$

STATIC ELECTRICAL CHARACTERISTICS (per diode)

Symbol	Parameter	Tests Conditions		Min.	Typ.	Max.	Unit
I_R^*	Reverse leakage current	$T_j = 25^{\circ}\text{C}$	$V_R = V_{RRM}$			1.5	mA
		$T_j = 125^{\circ}\text{C}$			170	350	mA
V_F^*	Forward voltage drop	$T_j = 25^{\circ}\text{C}$	$I_F = 15\text{ A}$			0.46	V
		$T_j = 125^{\circ}\text{C}$	$I_F = 15\text{ A}$		0.33	0.37	
		$T_j = 25^{\circ}\text{C}$	$I_F = 30\text{ A}$			0.57	
		$T_j = 125^{\circ}\text{C}$	$I_F = 30\text{ A}$		0.43	0.5	

Pulse test : * $t_p = 380\ \mu\text{s}$, $\delta < 2\%$

To evaluate the conduction losses use the following equation :
 $P = 0.24 \times I_{F(AV)} + 0.009 \times I_{F(RMS)}^2$

Fig. 1: Average forward power dissipation versus average forward current (per diode).

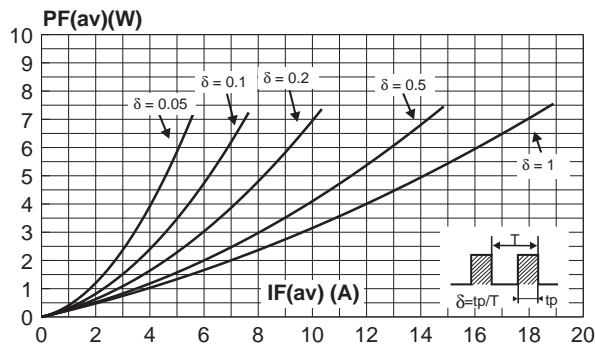

Fig. 2: Average current versus ambient temperature ($\delta=0.5$) (per diode).

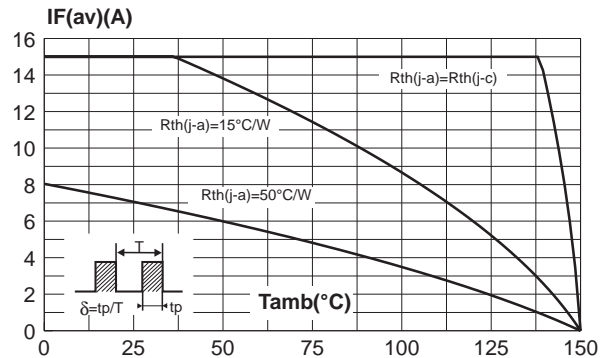

Fig. 3: Non repetitive surge peak forward current versus overload duration (maximum values) (per diode).

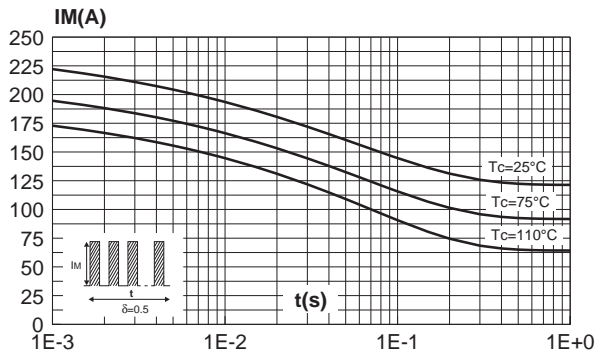

Fig. 4: Relative variation of thermal transient impedance junction to case versus pulse duration.

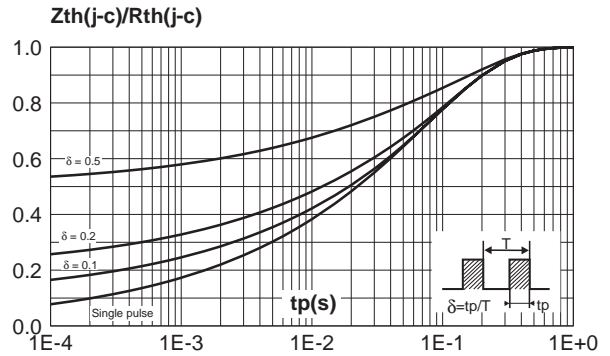

Fig. 5: Reverse leakage current versus reverse voltage applied (typical values) (per diode).

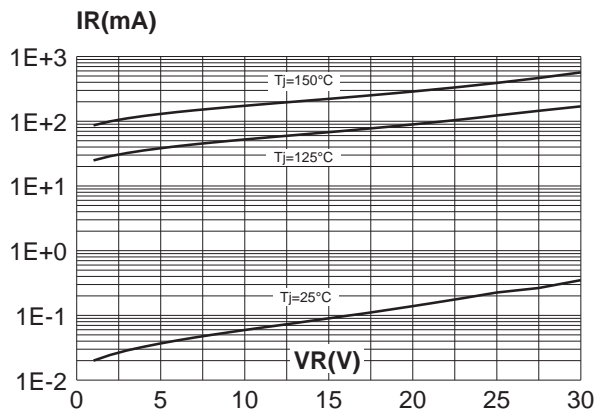

Fig. 6: Junction capacitance versus reverse voltage applied (typical values) (per diode).

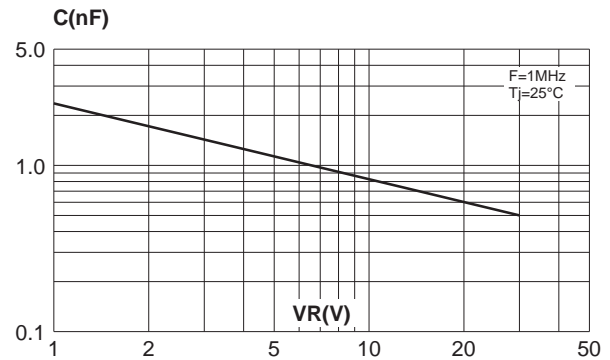

Fig. 7: Forward voltage drop versus forward current (maximum values - per diode).

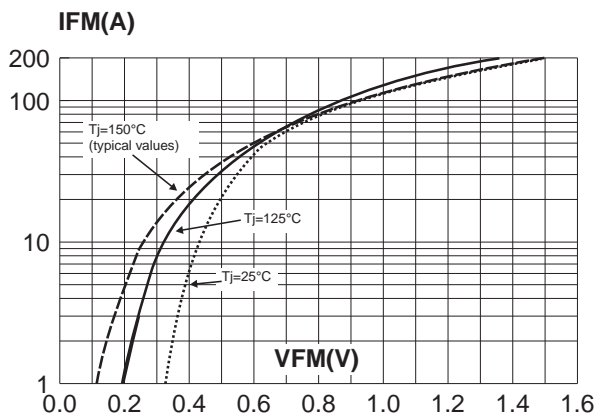
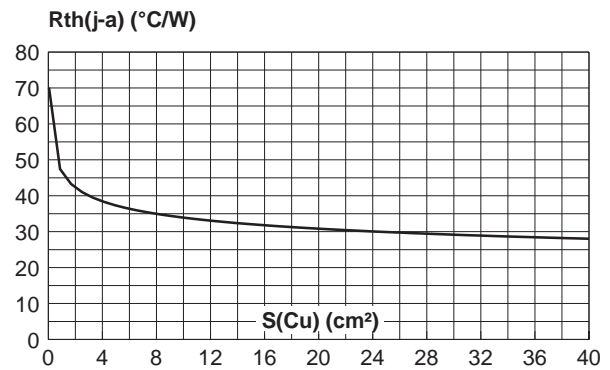
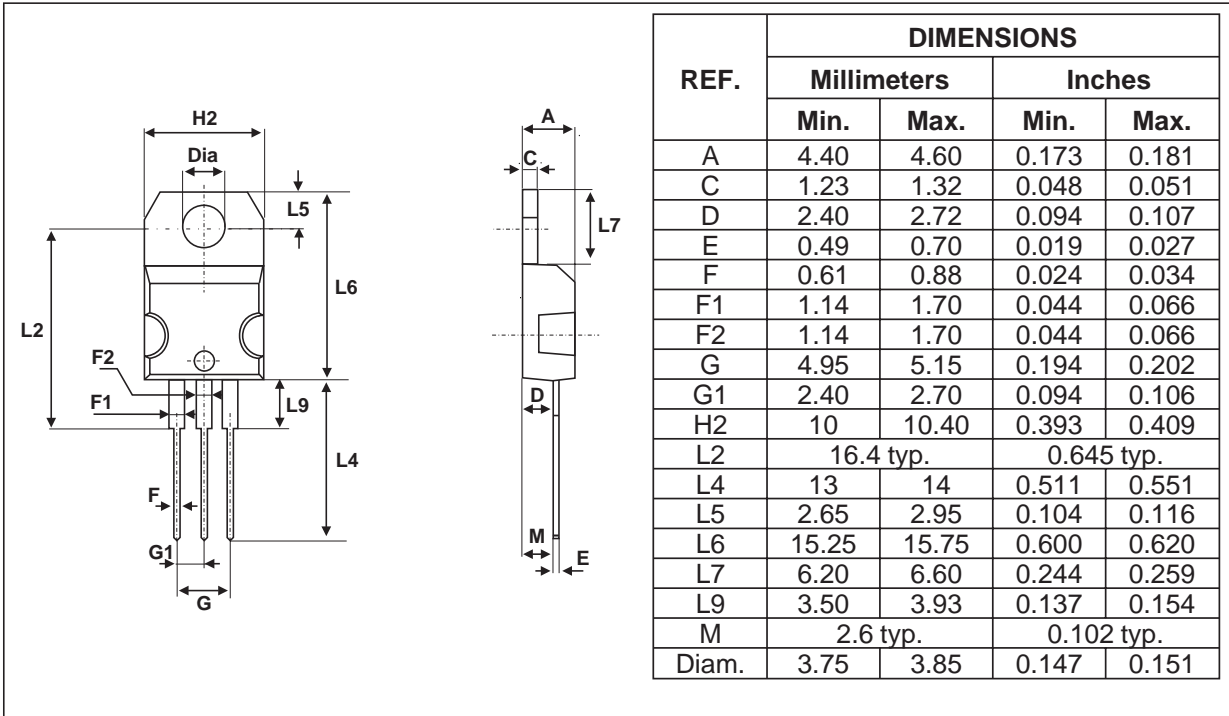

Fig. 8: Thermal resistance junction to ambient versus copper surface under tab (epoxy printed circuit board FR4, e(Cu) = 35 μm) (STPS30L30CG).



STPS30L30CT/CG/CG-1

PACKAGE MECHANICAL DATA
TO-220AB



- Cooling method: C
- Recommended torque value: 0.55 m.N
- Maximum torque value: 0.70 m.N

PACKAGE MECHANICAL DATA
I²PAK

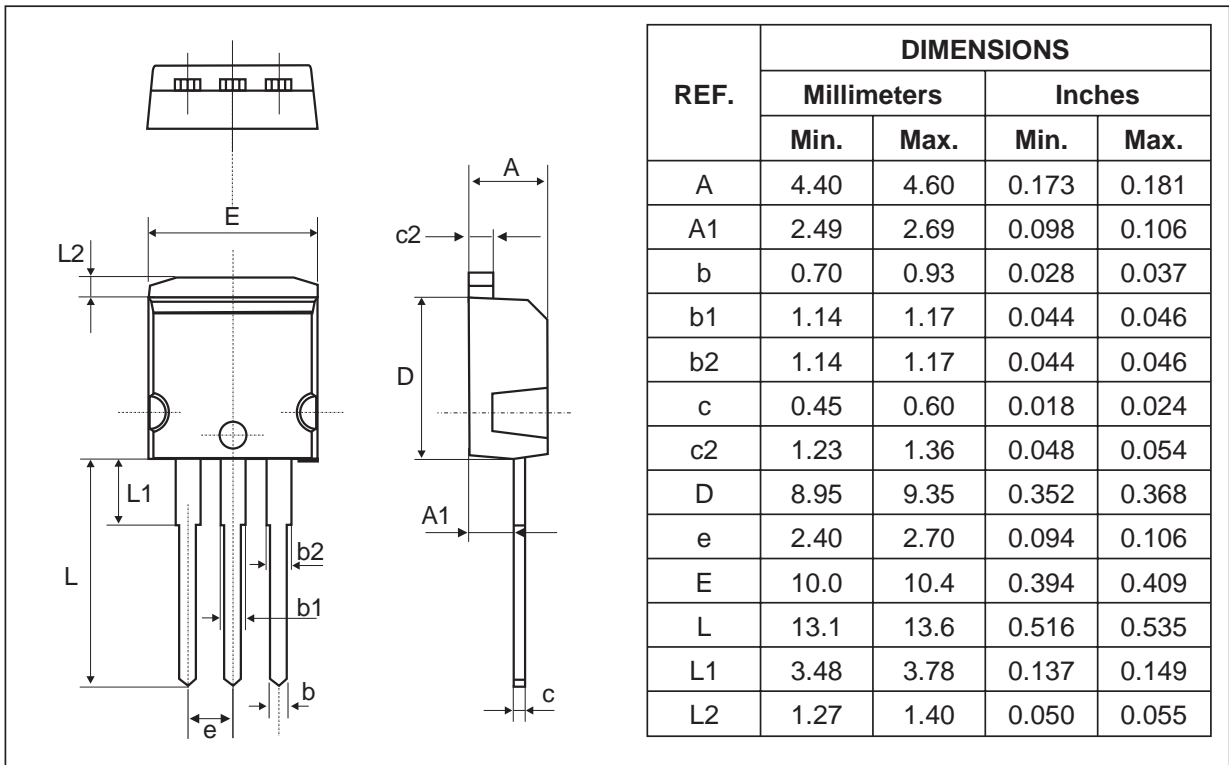

PACKAGE MECHANICAL DATA
D²PAK

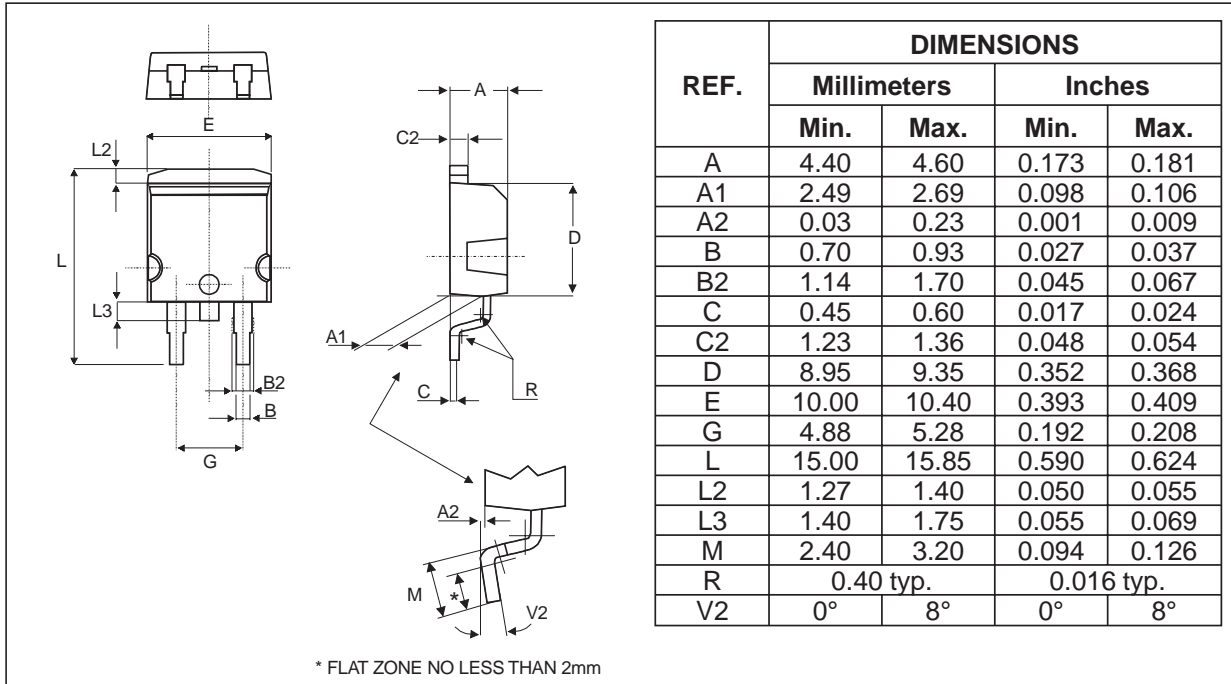

FOOT PRINT (in millimeters)

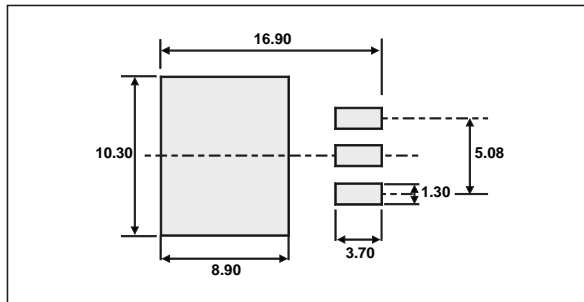

Ordering type	Marking	Package	Weight	Base qty	Delivery mode
STPS30L30CT	STPS30L30CT	TO-220AB	2g	50	Tube
STPS30L30CG	STPS30L30CG	D ² PAK	1.8g	50	Tube
STPS30L30CG-TR	STPS30L30CG	D ² PAK	1.8g	1000	Tape & reel
STPS30L30CG-1	STPS30L30CG-1	I ² PAK	1.49g	50	Tube

- Epoxy meets UL94,V0

Information furnished is believed to be accurate and reliable. However, STMicroelectronics assumes no responsibility for the consequences of use of such information nor for any infringement of patents or other rights of third parties which may result from its use. No license is granted by implication or otherwise under any patent or patent rights of STMicroelectronics. Specifications mentioned in this publication are subject to change without notice. This publication supersedes and replaces all information previously supplied. STMicroelectronics products are not authorized for use as critical components in life support devices or systems without express written approval of STMicroelectronics.

The ST logo is a registered trademark of STMicroelectronics
© 2000 STMicroelectronics - Printed in Italy - All rights reserved.

STMicroelectronics GROUP OF COMPANIES
Australia - Brazil - China - Finland - France - Germany - Hong Kong - India - Italy - Japan - Malaysia
Malta - Morocco - Singapore - Spain - Sweden - Switzerland - United Kingdom - U.S.A.

<http://www.st.com>

