

**IF AMPLIFIER WITH DEMODULATOR AND AFC**

- SUPPLY VOLTAGE : 12V TYP
- SUPPLY CURRENT : 50mA TYP
- I.F. INPUT VOLTAGE SENSITIVITY AT F = 38.9MHz : 85 $\mu$ V<sub>RMS</sub> TYP
- VIDEO OUTPUT VOLTAGE (white at 10% of top synchro) : 2.7V<sub>PP</sub> TYP
- I.F. VOLTAGE GAIN CONTROL RANGE : 64dB TYP
- SIGNAL TO NOISE RATIO AT V<sub>I</sub> = 10mV : 58dB TYP
- A.F.C. OUTPUT VOLTAGE SWING FOR  $\Delta f = 100\text{kHz}$  : 10V TYP

**DESCRIPTION**

The TDA2540 and 2541 are IF amplifier and A.M. demodulator circuits for colour and black and white television receivers using PNP or NPN tuners. They are intended for reception of negative or positive modulation CCIR standard.

They incorporate the following functions :

- Gain controlled amplifier
- Synchronous demodulator
- White spot inverter
- Video preamplifier with noise protection
- Switchable AFC
- AGC with noise gating
- Tuner AGC output (NPN tuner for 2540)-(PNP tuner for 2541)
- VCR switch for video output inhibition (VCR play back)

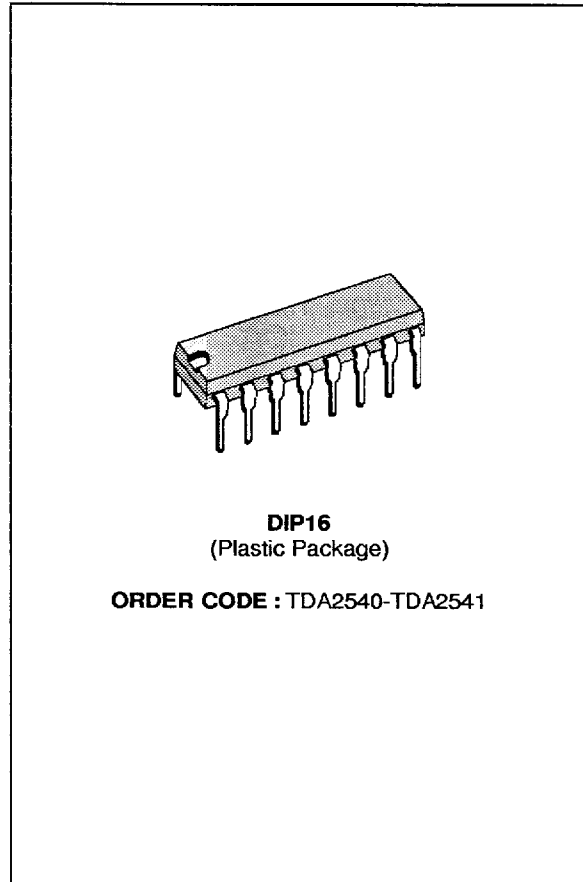

**PIN CONNECTIONS**

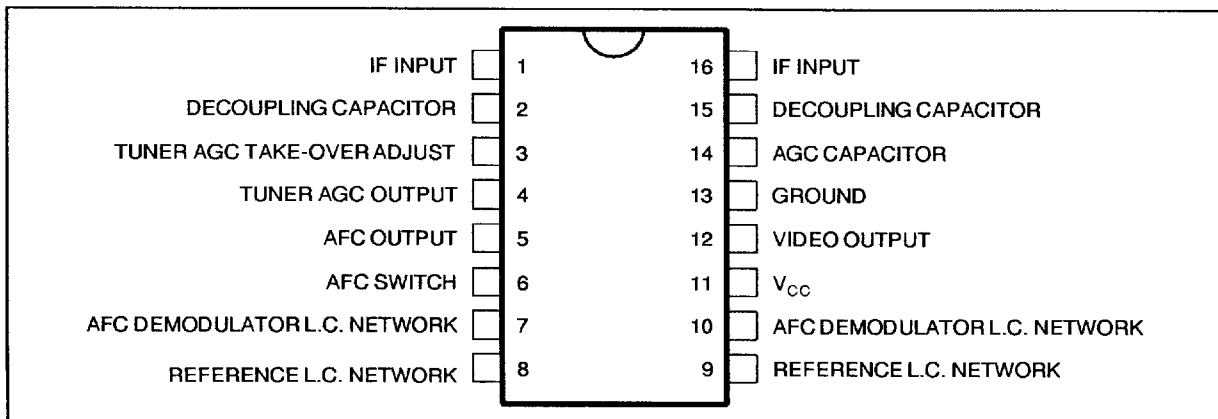

**BLOCK DIAGRAM**

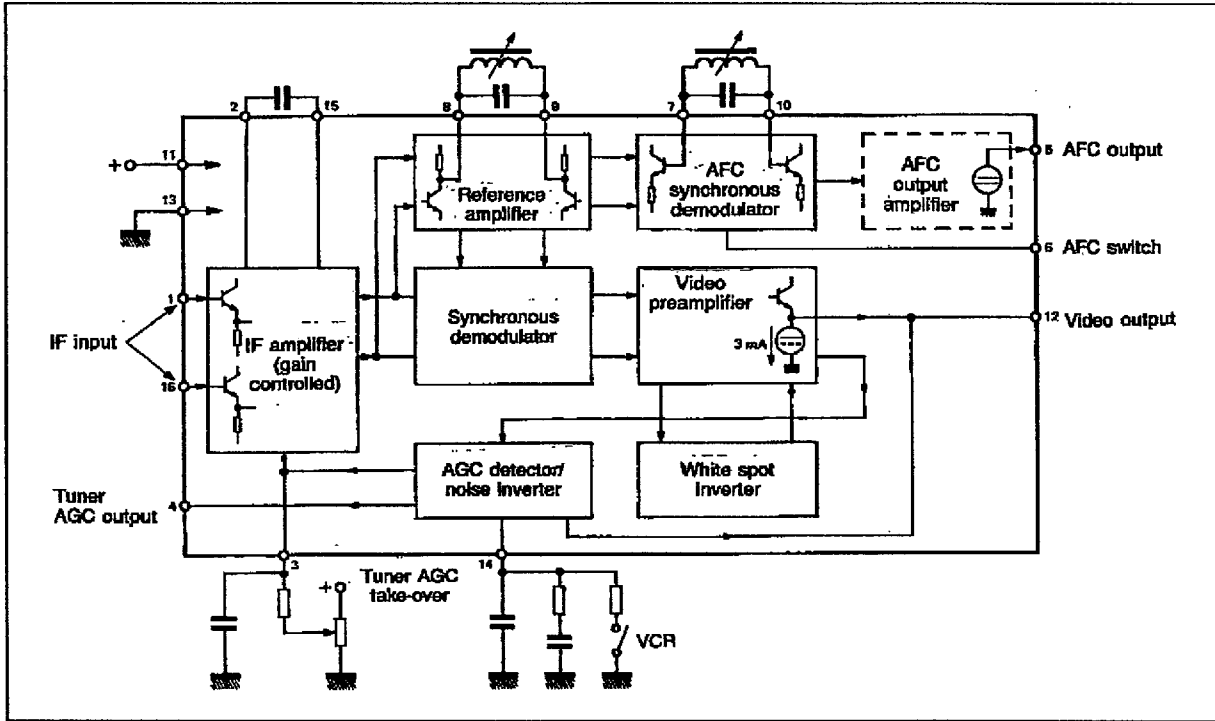

**ABSOLUTE MAXIMUM RATINGS**

Symbol	Parameter	Value	Unit
V (11-13)	Supply Voltage	13.8	V
V (4-13)	Tuner A.G.C. Voltage	12	V
P <sub>tot</sub>	Power Dissipation	900	mW
T <sub>stg</sub>	Storage Temperature	- 55 to + 125	°C
T <sub>amb</sub>	Operating Ambient Temperature	0 to + 70	°C

**THERMAL DATA**

Symbol	Parameter	Value	Unit
R <sub>th(j-a)</sub>	Junction - ambient Thermal Resistance	70	°C/W

**ELECTRICAL OPERATING CHARACTERISTICS**

T<sub>amb</sub> = 25°C ; V<sub>11-13</sub> = 12V; f = 38.9MHz (unless otherwise specified)

Symbol	Parameter	Min.	Typ.	Max.	Unit
V <sub>11-13</sub>	Supply Voltage Range	10.2	12	13.8	V
I <sub>11</sub>	Supply Current		50	60	mA
V <sub>1-16</sub>	IF Input Voltage Sensitivity	60	85	180	μV <sub>RMS</sub>
	Max Input Voltage (Pins 1-16)		140		mV
V <sub>12-13</sub>	Video Output Voltage		2.7		V <sub>PP</sub>
Z <sub>1-16</sub>	Differential Input Impedance (in parallel with 2pF)		2		kΩ
V <sub>12-13</sub>	Zero Signal Output Level	5.7	6	6.3	V
V <sub>12-13</sub>	Top Synchro Output Level	2.9	3.07	3.2	V
ΔG <sub>v</sub>	IF Voltage Gain Control Range	52	64		dB

**ELECTRICAL OPERATING CHARACTERISTICS (continued)**

T<sub>amb</sub> = 25 °C; V (11 - 13) = 12 V; f = 38.9 MHz (unless otherwise specified)

Symbol	Parameter	Min.	Typ.	Max.	Unit
S/N	Signal to Noise Ratio (V <sub>i</sub> = 10mV) (see note 1)	50	58		dB
B	Bandwidth of Video Amplifier (- 3dB)		6		MHz
dG	Differential Gain		4	10	%
dφ	Differential Phase		2	10	%
V <sub>12-13</sub>	Carrier Signal at Video Output (V <sub>i</sub> = 10mV)		4	30	mV <sub>RMS</sub>
V <sub>12-13</sub>	2nd Harmonic of Carrier at Video Output (V <sub>i</sub> = 10mV)		20	30	mV <sub>RMS</sub>
	Intermodulation at 1.1MHz (blue) (see Figures 2 and 3)	46	60		dB
	Intermodulation at 1.1MHz (yellow) (see Figures 2 and 3)	46	50		dB
	Intermodulation at 3.3MHz (blue) (see Figures 2 and 3)	46	54		dB
V <sub>14-13</sub>	VCR Switches Off Output at : (VCR = low Level)			1.1	V
	White Spot Inverter Threshold Level (see Figure 1)		6.6		V
	White Spot Insertion Level (see Figure 1)		4.7		V
	Noise Inverter Threshold Level (see Figure 1)		1.8		V
	Noise Insertion Level (see Figure 1)		3.8		V
I <sub>4</sub>	Tuner AGC output Current Range		0 to 10		mA
V <sub>14-13</sub>	Tuner AGC Output Voltage			0.3	V
I <sub>4</sub>	Tuner AGC Output Leakage Current TDA2541 V <sub>14-13</sub> = 11V, V <sub>4-13</sub> = 12V TDA2540 V <sub>14-13</sub> = 5V, V <sub>4-13</sub> = 12V			15	μA
ΔV <sub>5-13</sub>	AFC Output Voltage Swing (Δf = 100 kHz)	10	11		V
Δf	Change of Frequency at AFC Output (voltage swing of 10V)		100	200	kHz
V <sub>6-13</sub>	AFC Switches OFF (AFC = low level) at :			2.5	V
V <sub>6-13</sub>	AFC Switches LOW (AFC = High level) at :	3.2			V
V <sub>5-13</sub>	AFC Zero = Signal Output Voltage (minimum gain)	4	6	8	V

Note : 1.  $\frac{S}{N} = \frac{V_O(\text{black to white})}{V_N \cdot (\text{RMS at } B = 5\text{MHz})}$  (dB)

**Figure 1 : Video Output Waveform Showing White Spot and Noise Inverter Threshold Levels**

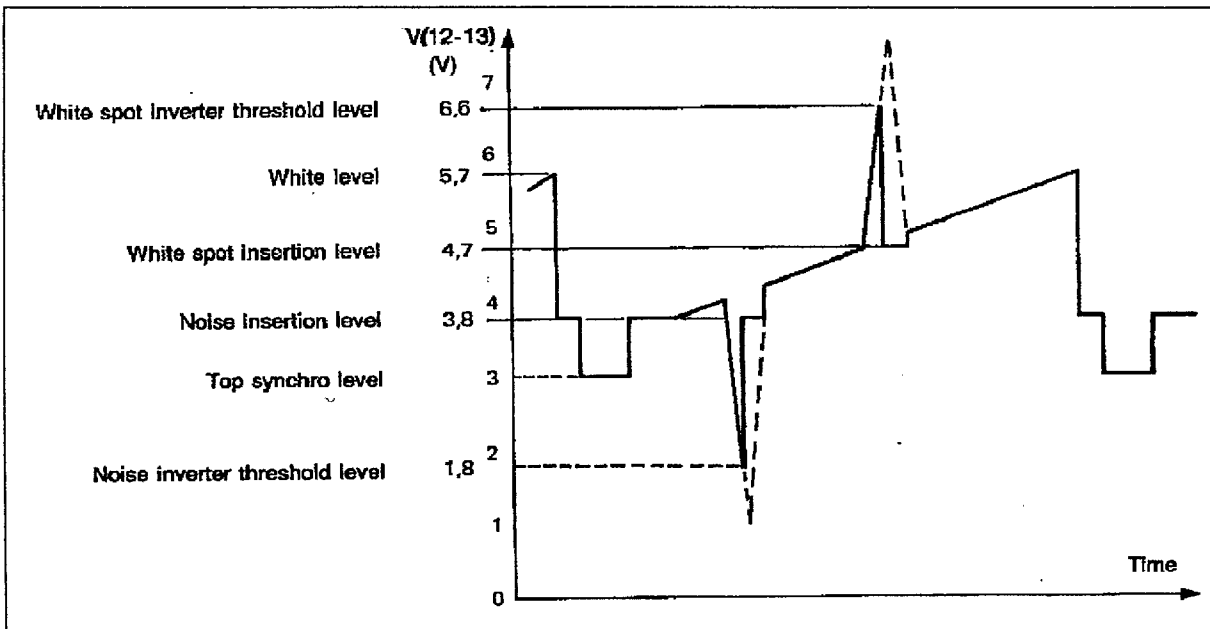

Figure 2 : Input Conditions for Intermodulation Measurements

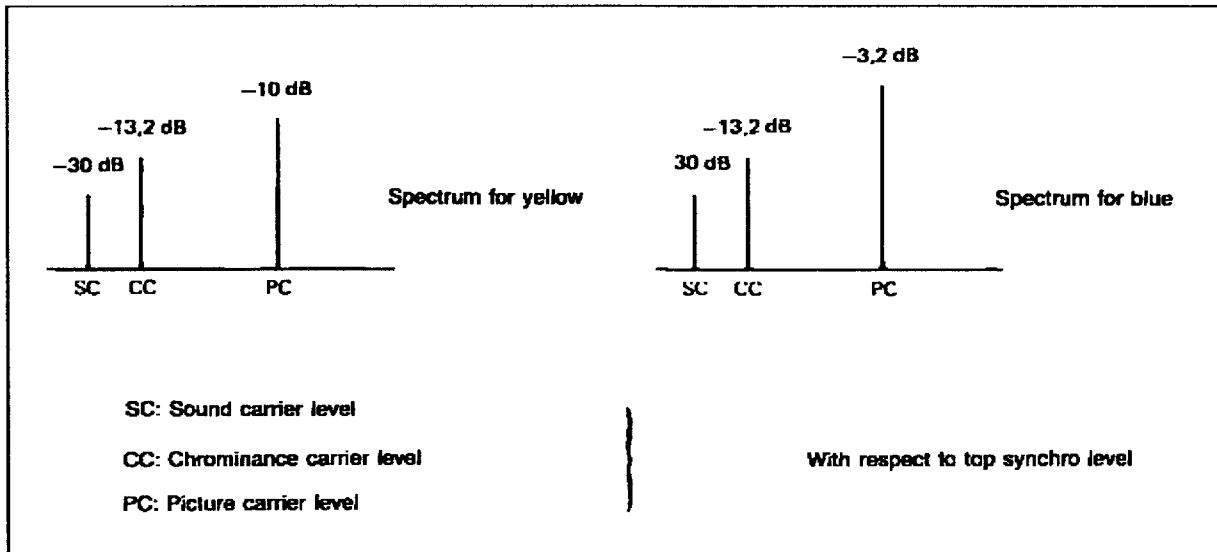

Figure 3 : Test Set-up for Intermodulation

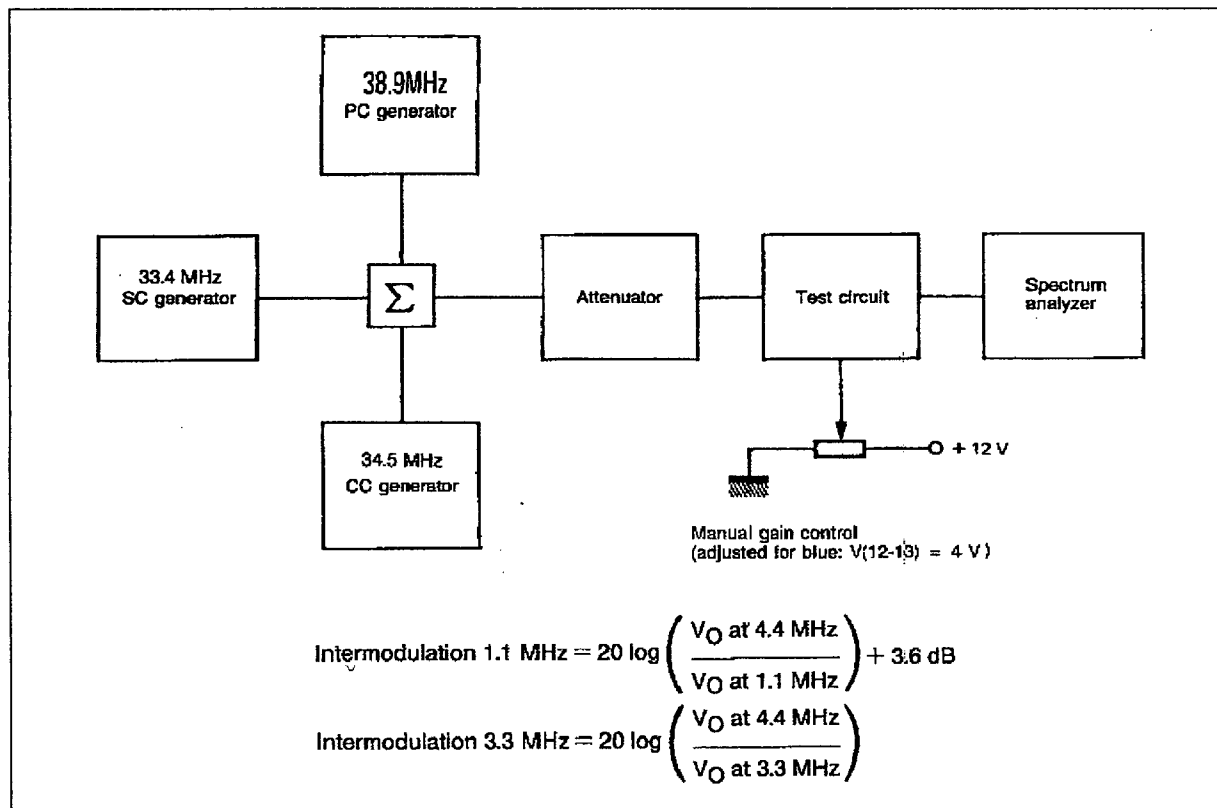

Figure 4 : AFC Voltage versus Frequency V<sub>5-13</sub>

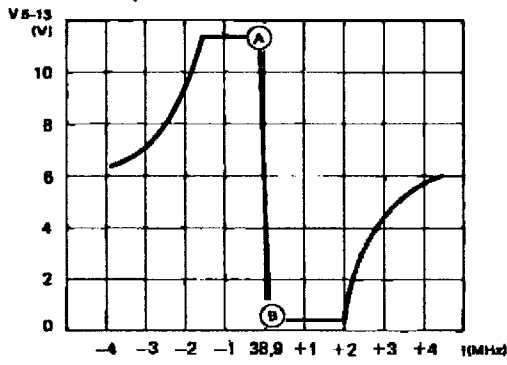

Fig. 4 — AFC VOLTAGE VERSUS FREQUENCY V 5-13

2540-06.EPS

Figure 5 : AFC Voltage versus Frequency V<sub>5-13</sub>

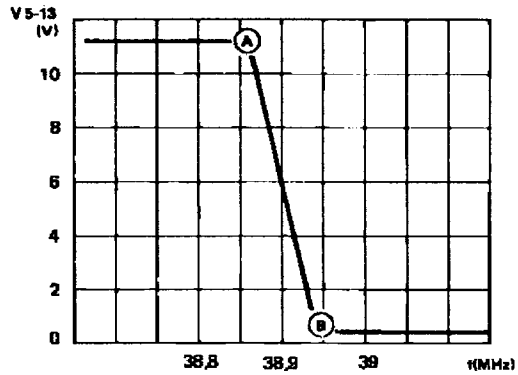

Fig. 5 — AFC VOLTAGE VERSUS FREQUENCY V 5-13

2540-07.EPS

Figure 6 : Signal/Noise Ratio versus Input Voltage V<sub>1-16</sub>

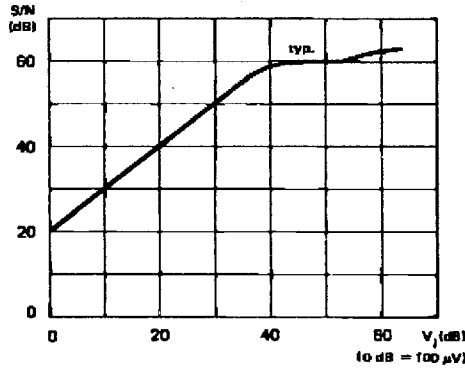
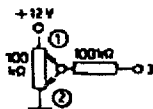
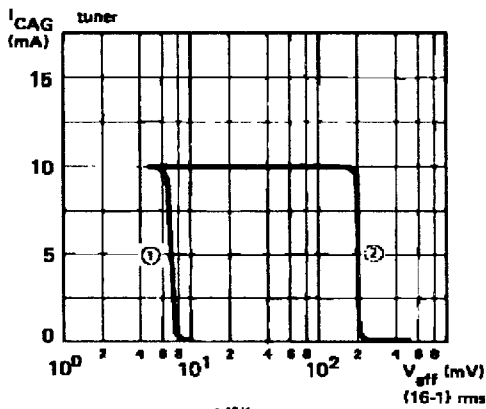

Fig. 6 — SIGNAL/NOISE RATIO VERSUS INPUT VOLTAGE V 1-16

2540-08.EPS

Figure 7 : AGC Tuner Current Curve  
TDA2540



2540-09.EPS

TDA2541

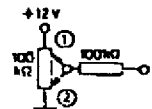
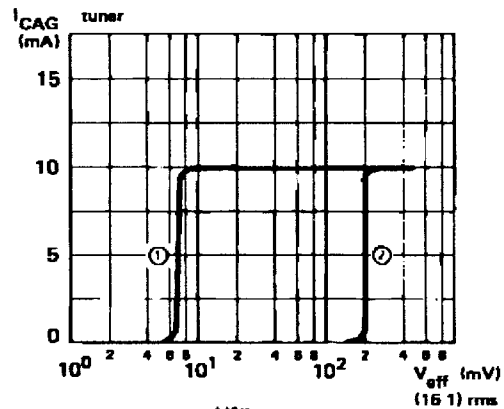

2540-10.EPS

Figure 7 : AGC Tuner Current Curve (continued)

TDA2540 - TDA2541

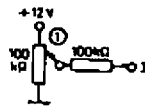
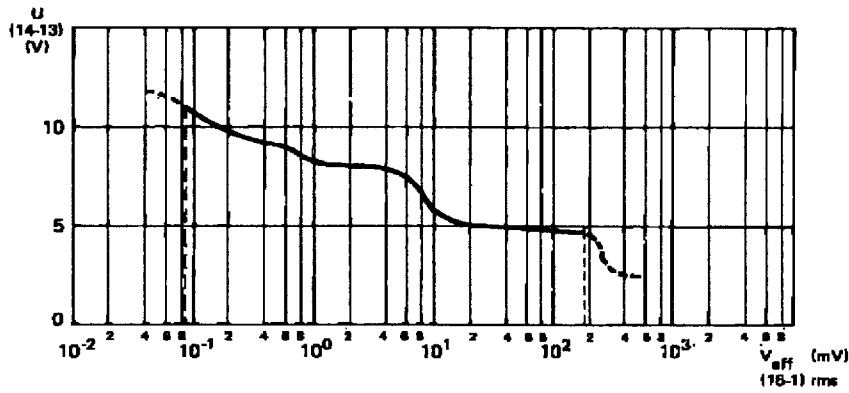

2540-11.EPS

APPLICATION CIRCUIT

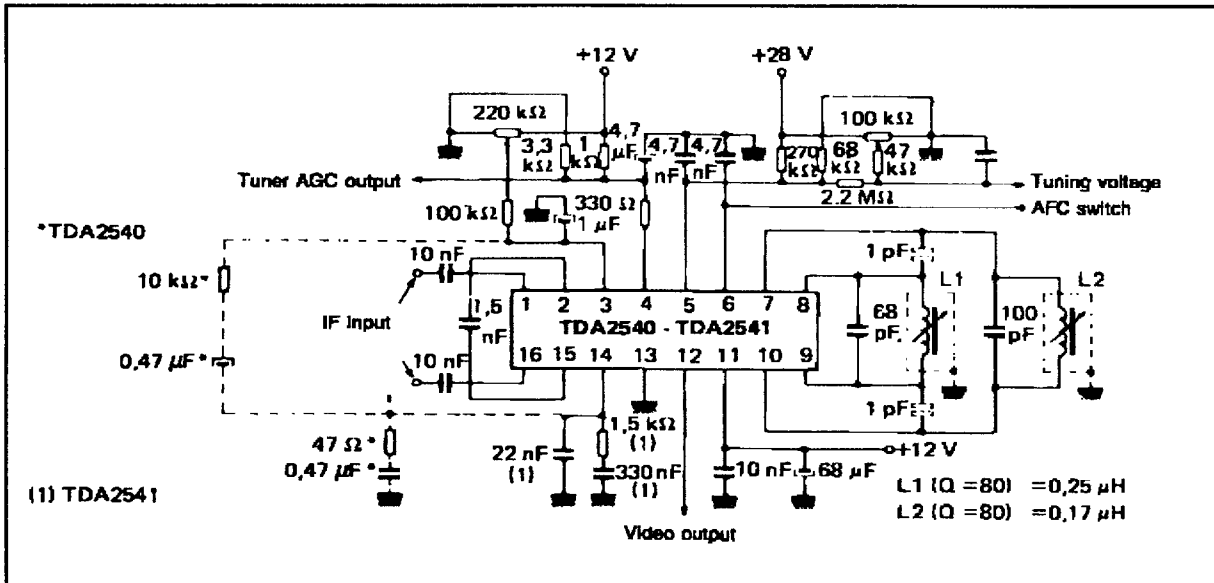

2540-12.EPS

**PACKAGE MECHANICAL DATA**  
16 PINS - PLASTIC DIP

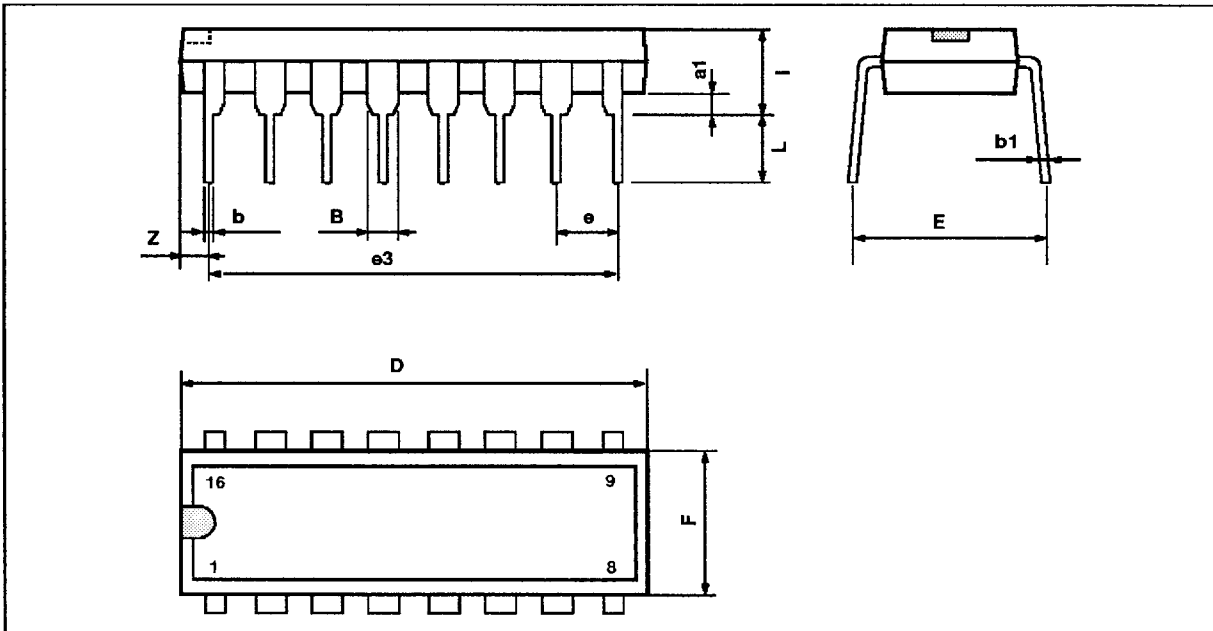

PM-DIP16.EPS

Dimensions	Millimeters			Inches		
	Min.	Typ.	Max.	Min.	Typ.	Max.
a1	0.51			0.020		
B	0.77		1.65	0.030		0.065
b		0.5			0.020	
b1		0.25			0.010	
D			20			0.787
E		8.5			0.335	
e		2.54			0.100	
e3		17.78			0.700	
F			7.1			0.280
i			5.1			0.201
L		3.3			0.130	
Z			1.27			0.050

DIP16.TBL

Information furnished is believed to be accurate and reliable. However, SGS-THOMSON Microelectronics assumes no responsibility for the consequences of use of such information nor for any infringement of patents or other rights of third parties which may result from its use. No licence is granted by implication or otherwise under any patent or patent rights of SGS-THOMSON Microelectronics. Specifications mentioned in this publication are subject to change without notice. This publication supersedes and replaces all information previously supplied. SGS-THOMSON Microelectronics products are not authorized for use as critical components in life support devices or systems without express written approval of SGS-THOMSON Microelectronics.

© 1994 SGS-THOMSON Microelectronics - All Rights Reserved

Purchase of  $\mu$ C Components of SGS-THOMSON Microelectronics, conveys a license under the Philips  $\mu$ C Patent. Rights to use these components in a  $\mu$ C system, is granted provided that the system conforms to the  $\mu$ C Standard Specifications as defined by Philips.

SGS-THOMSON Microelectronics GROUP OF COMPANIES

Australia - Brazil - China - France - Germany - Hong Kong - Italy - Japan - Korea - Malaysia - Malta - Morocco  
The Netherlands - Singapore - Spain - Sweden - Switzerland - Taiwan - Thailand - United Kingdom - U.S.A.



7929237 0074828 96T