

# BCR16PM

MEDIUM POWER USE

INSULATED TYPE, PLANAR PASSIVATION TYPE

Refer to the page 6 as to the product guaranteed maximum junction temperature 150°C

**BCR16PM**

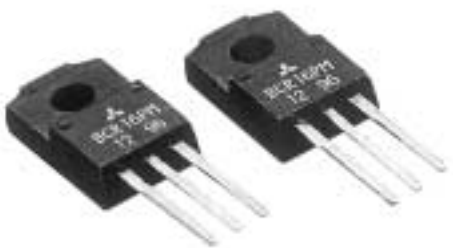

- **IT (RMS)** ..... **16A**
- **VDRM** ..... **600V**
- **IFGT I , IRGT I , IRGT III** ..... **20mA**
- **Viso** ..... **2000V**
- **UL Recognized:Yellow Card No. E80276(N)**
- **File No. E80271**

**OUTLINE DRAWING** Dimensions in mm

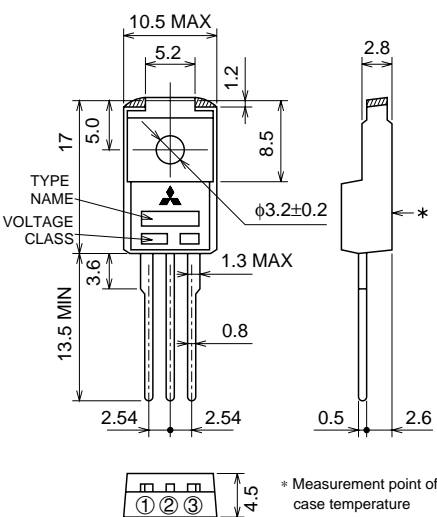

\* Measurement point of case temperature

TO-220F

## APPLICATION

Contactless AC switches, light dimmer, electric flasher unit, hair drier, control of household equipment such as TV sets · refrigerator · washing machine · electric fan, other general purpose control applications

## MAXIMUM RATINGS

Symbol	Parameter	Voltage class		Unit
		12		
VDRM	Repetitive peak off-state voltage *1	600		V
VDSM	Non-repetitive peak off-state voltage *1	720		V

Symbol	Parameter	Conditions	Ratings	Unit
IT (RMS)	RMS on-state current	Commercial power frequency, sine full wave 360° conduction, Tc=71°C	16	A
ITSM	Surge on-state current	60Hz sinewave 1 full cycle, peak value, non-repetitive	160	A
I <sup>2</sup> <sub>t</sub>	I <sup>2</sup> <sub>t</sub> for fusing	Value corresponding to 1 cycle of half wave 60Hz, surge on-state current	106.5	A <sup>2</sup> s
PGM	Peak gate power dissipation		5.0	W
PG (AV)	Average gate power dissipation		0.5	W
VGM	Peak gate voltage		10	V
IGM	Peak gate current		2	A
T <sub>j</sub>	Junction temperature		-40 ~ +125	°C
T <sub>stg</sub>	Storage temperature		-40 ~ +125	°C
—	Weight	Typical value	2.0	g
Viso	Isolation voltage	Ta=25°C, AC 1 minute, T1 · T2 · G terminal to case	2000	V

\*1. Gate open.

**BCR16PM**

Refer to the page 6 as to the product guaranteed maximum junction temperature 150°C

**MEDIUM POWER USE**  
**INSULATED TYPE, PLANAR PASSIVATION TYPE**

**ELECTRICAL CHARACTERISTICS**

Symbol	Parameter	Test conditions	Limits			Unit	
			Min.	Typ.	Max.		
IDRM	Repetitive peak off-state current	T <sub>j</sub> =125°C, V <sub>DRM</sub> applied	—	—	2.0	mA	
V <sub>TM</sub>	On-state voltage	T <sub>c</sub> =25°C, I <sub>TM</sub> =25A, Instantaneous measurement	—	—	1.5	V	
V <sub>FGT I</sub>	Gate trigger voltage *2	T <sub>j</sub> =25°C, V <sub>D</sub> =6V, R <sub>L</sub> =6Ω, R <sub>G</sub> =330Ω	I	—	—	1.5	V
V <sub>RGT I</sub>			II	—	—	1.5	V
V <sub>RGT III</sub>			III	—	—	1.5	V
I <sub>FGT I</sub>	Gate trigger current *2	T <sub>j</sub> =25°C, V <sub>D</sub> =6V, R <sub>L</sub> =6Ω, R <sub>G</sub> =330Ω	I	—	—	20	mA
I <sub>RGT I</sub>			II	—	—	20	mA
I <sub>RGT III</sub>			III	—	—	20	mA
V <sub>GD</sub>	Gate non-trigger voltage	T <sub>j</sub> =125°C, V <sub>D</sub> =1/2V <sub>DRM</sub>	0.2	—	—	V	
R <sub>th(j-c)</sub>	Thermal resistance	Junction to case *3	—	—	3.0	°C/W	
(dv/dt) <sub>c</sub>	Critical-rate of rise of off-state commutating voltage *4	T <sub>j</sub> =125°C	10	—	—	V/μs	

\*2. Measurement using the gate trigger characteristics measurement circuit.

\*3. The contact thermal resistance R<sub>th(c-f)</sub> in case of greasing is 0.5°C/W.

\*4. Test conditions of the critical-rate of rise of off-state commutating voltage is shown in the table below.

Test conditions	Commutating voltage and current waveforms (inductive load)
1. Junction temperature T <sub>j</sub> =125°C  2. Rate of decay of on-state commutating current (di/dt) <sub>c</sub> =-8.0A/ms  3. Peak off-state voltage V <sub>D</sub> =400V	

**PERFORMANCE CURVES**

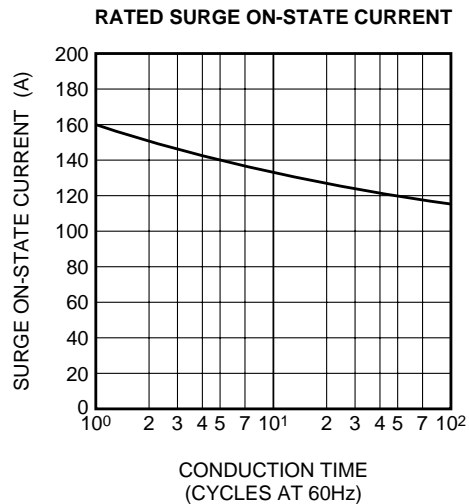
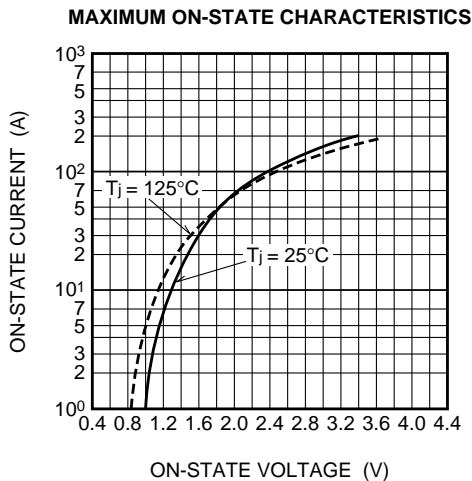

# BCR16PM

Refer to the page 6 as to the product guaranteed maximum junction temperature 150°C

MEDIUM POWER USE  
INSULATED TYPE, PLANAR PASSIVATION TYPE

**GATE CHARACTERISTICS  
(I, II AND III)**

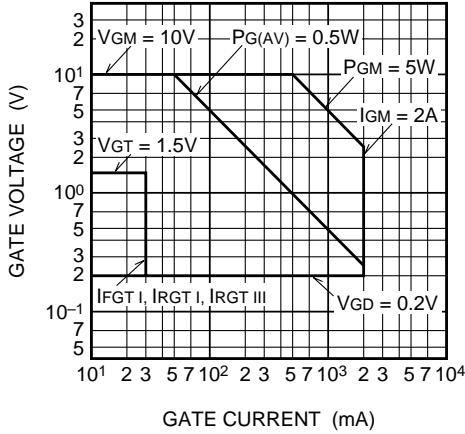

**GATE TRIGGER CURRENT VS.  
JUNCTION TEMPERATURE**

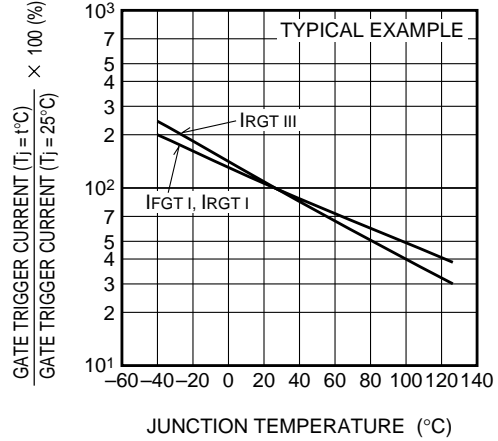

**GATE TRIGGER VOLTAGE VS.  
JUNCTION TEMPERATURE**

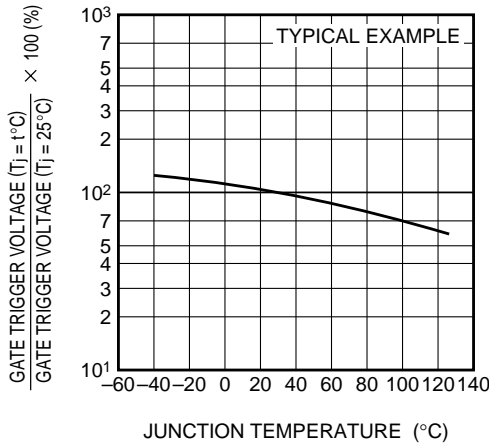

**MAXIMUM TRANSIENT THERMAL  
IMPEDANCE CHARACTERISTICS  
(JUNCTION TO CASE)**

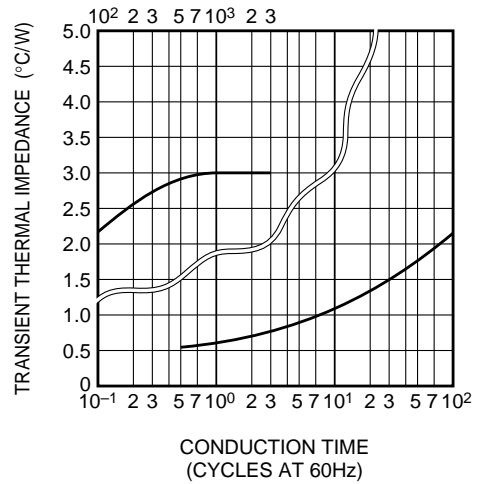

**MAXIMUM TRANSIENT THERMAL  
IMPEDANCE CHARACTERISTICS  
(JUNCTION TO AMBIENT)**

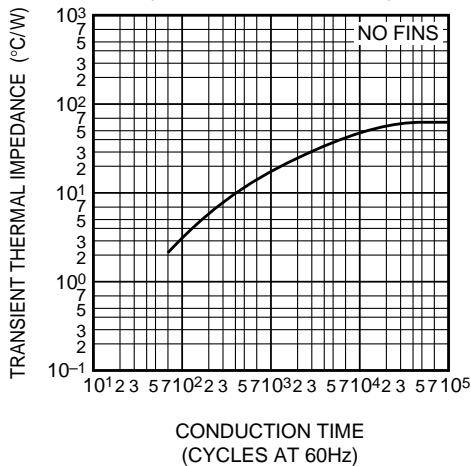

**MAXIMUM ON-STATE POWER  
DISSIPATION**

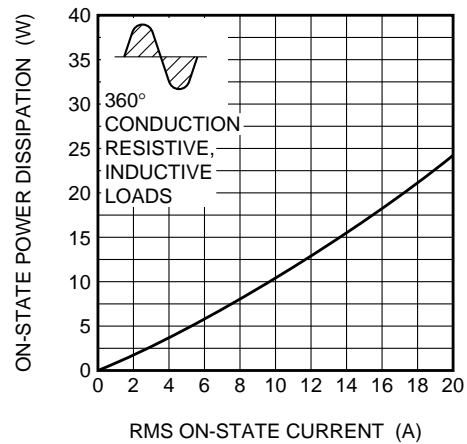

**BCR16PM**

Refer to the page 6 as to the product guaranteed maximum junction temperature 150°C

**MEDIUM POWER USE**  
**INSULATED TYPE, PLANAR PASSIVATION TYPE**

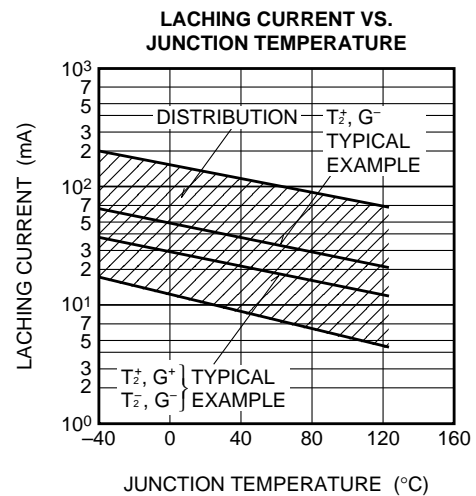
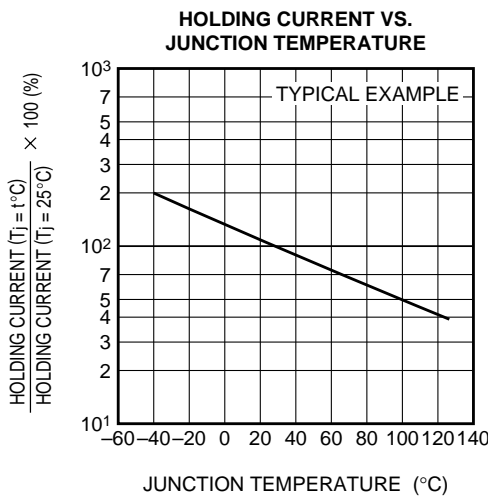
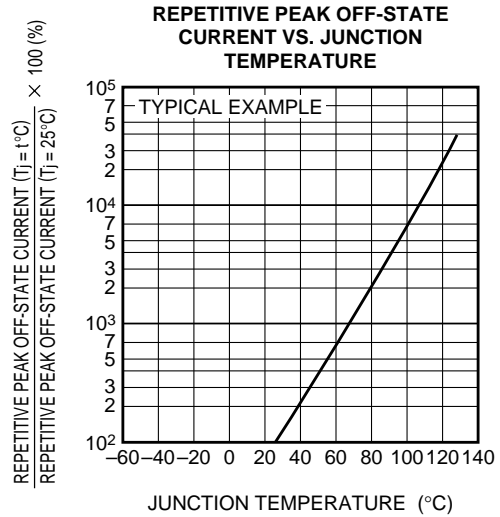
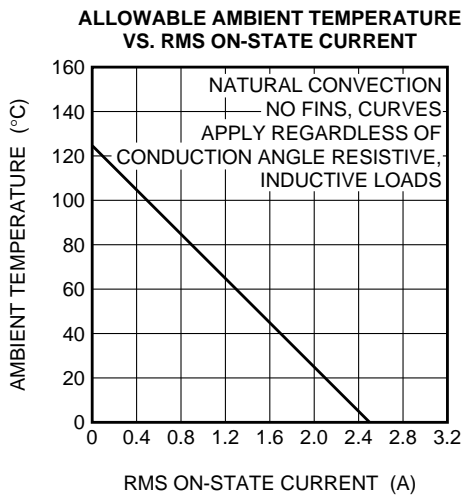
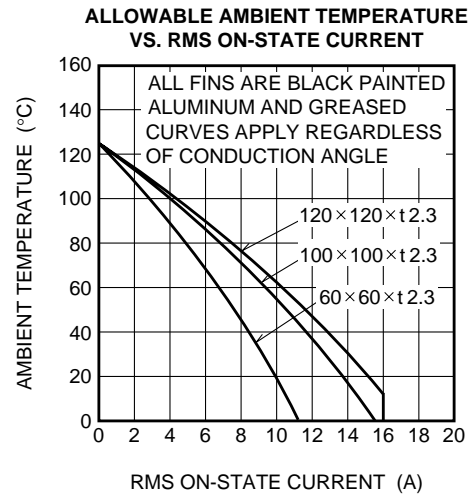
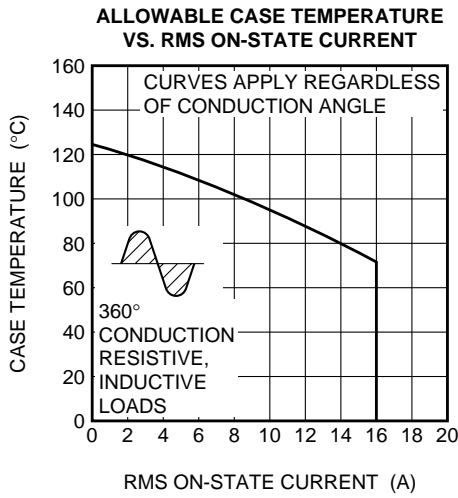

# BCR16PM

Refer to the page 6 as to the product guaranteed maximum junction temperature 150°C

MEDIUM POWER USE  
INSULATED TYPE, PLANAR PASSIVATION TYPE

**BREAKOVER VOLTAGE VS. JUNCTION TEMPERATURE**

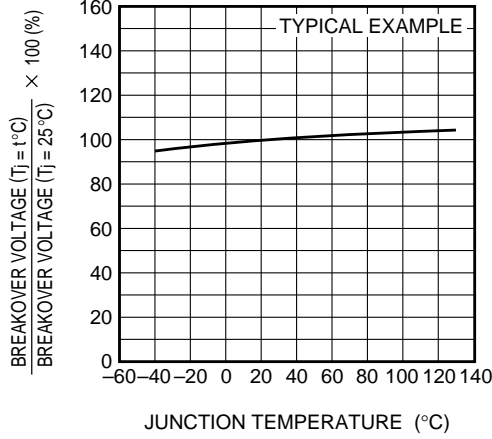

**BREAKOVER VOLTAGE VS. RATE OF RISE OF OFF-STATE VOLTAGE**

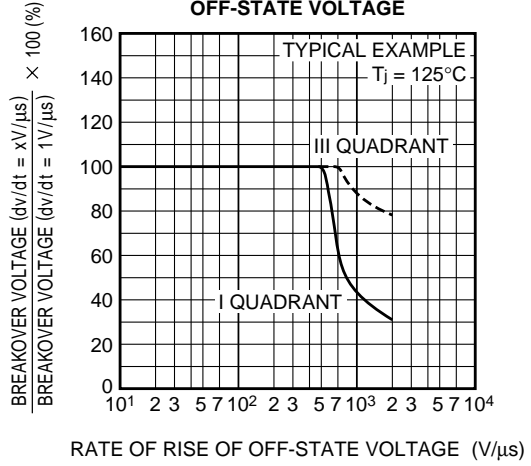

**COMMUTATION CHARACTERISTICS**

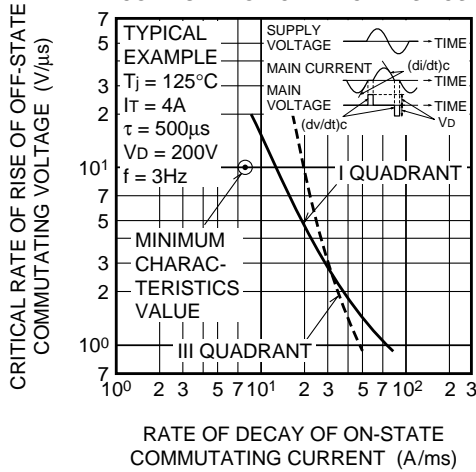

**GATE TRIGGER CURRENT VS. GATE CURRENT PULSE WIDTH**

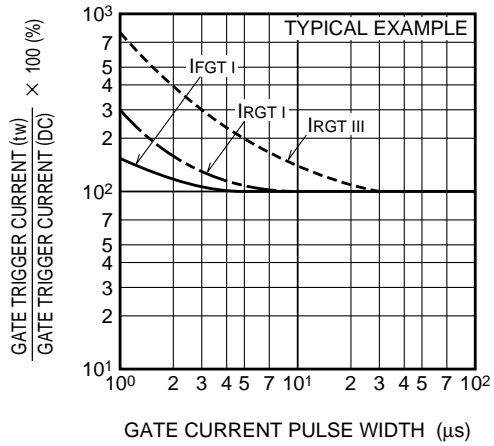

**GATE TRIGGER CHARACTERISTICS TEST CIRCUITS**

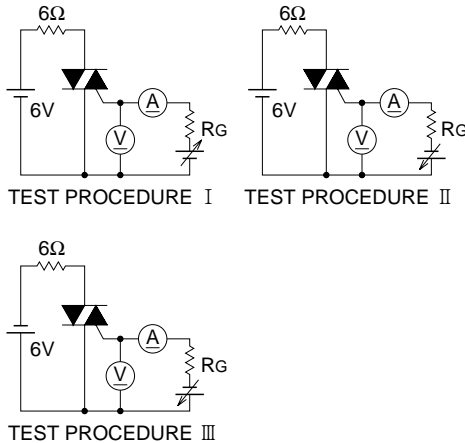

# BCR16PM

MEDIUM POWER USE

INSULATED TYPE, PLANAR PASSIVATION TYPE

The product guaranteed maximum junction temperature 150°C (See warning.)

**BCR16PM**

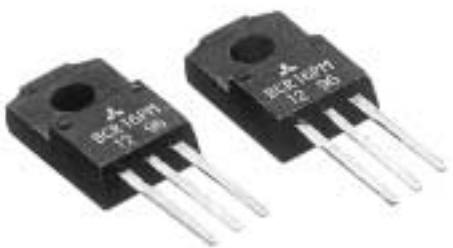

- **IT (RMS)** ..... **16A**
- **VDRM** ..... **600V**
- **IFGT I , IRGT I , IRGT III** ..... **20mA**
- **Viso** ..... **2000V**
- **UL Recognized:Yellow Card No. E80276(N)**

**File No. E80271**

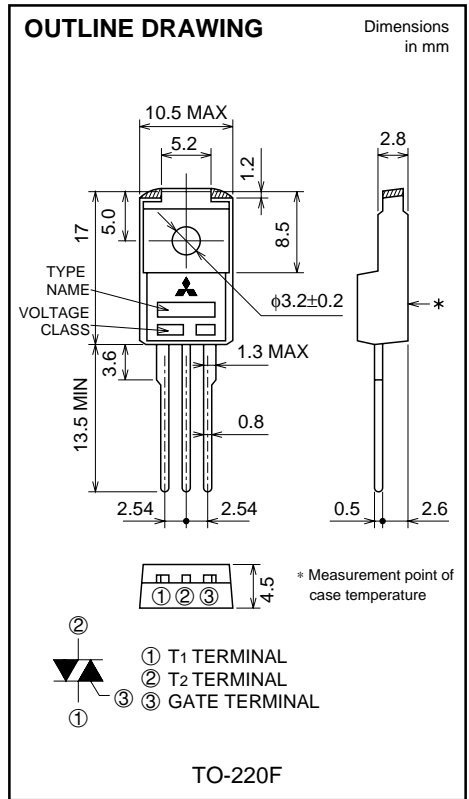

## APPLICATION

Contactless AC switches, light dimmer, electric flasher unit, hair drier, control of household equipment such as TV sets · refrigerator · washing machine · electric fan, other general purpose control applications

(Warning)

1. Refer to the recommended circuit values around the triac before using.
2. Be sure to exchange the specification before using. If not exchanged, general triacs will be supplied.

## MAXIMUM RATINGS

Symbol	Parameter	Voltage class		Unit
		12		
VDRM	Repetitive peak off-state voltage *1	600		V
VDSM	Non-repetitive peak off-state voltage *1	720		V

Symbol	Parameter	Conditions	Ratings	Unit
IT (RMS)	RMS on-state current	Commercial power frequency, sine full wave 360° conduction, T <sub>c</sub> =96°C	16	A
ITSM	Surge on-state current	60Hz sinewave 1 full cycle, peak value, non-repetitive	160	A
I <sup>2</sup> <sub>t</sub>	I <sup>2</sup> <sub>t</sub> for fusing	Value corresponding to 1 cycle of half wave 60Hz, surge on-state current	106.5	A <sup>2</sup> s
PGM	Peak gate power dissipation		5.0	W
PG (AV)	Average gate power dissipation		0.5	W
VGM	Peak gate voltage		10	V
IGM	Peak gate current		2	A
T <sub>j</sub>	Junction temperature		-40 ~ +150	°C
T <sub>stg</sub>	Storage temperature		-40 ~ +150	°C
—	Weight	Typical value	2.0	g
Viso	Isolation voltage	T <sub>a</sub> =25°C, AC 1 minute, T <sub>1</sub> · T <sub>2</sub> · G terminal to case	2000	V

\*1. Gate open.

# BCR16PM

The product guaranteed maximum junction temperature 150°C (See warning.)

**MEDIUM POWER USE**  
**INSULATED TYPE, PLANAR PASSIVATION TYPE**

## ELECTRICAL CHARACTERISTICS

Symbol	Parameter	Test conditions	Limits			Unit	
			Min.	Typ.	Max.		
IDRM	Repetitive peak off-state current	T <sub>j</sub> =150°C, V <sub>DRM</sub> applied	—	—	2.0	mA	
V <sub>TM</sub>	On-state voltage	T <sub>c</sub> =25°C, I <sub>TM</sub> =25A, Instantaneous measurement	—	—	1.5	V	
V <sub>FGT I</sub>	Gate trigger voltage *2	T <sub>j</sub> =25°C, V <sub>D</sub> =6V, R <sub>L</sub> =6Ω, R <sub>G</sub> =330Ω	I	—	—	1.5	V
V <sub>RGT I</sub>			II	—	—	1.5	V
V <sub>RGT III</sub>			III	—	—	1.5	V
I <sub>FGT I</sub>	Gate trigger current *2	T <sub>j</sub> =25°C, V <sub>D</sub> =6V, R <sub>L</sub> =6Ω, R <sub>G</sub> =330Ω	I	—	—	20	mA
I <sub>RGT I</sub>			II	—	—	20	mA
I <sub>RGT III</sub>			III	—	—	20	mA
V <sub>GD</sub>	Gate non-trigger voltage	T <sub>j</sub> =125°C/150°C, V <sub>D</sub> =1/2V <sub>DRM</sub>	0.2/0.1	—	—	V	
R <sub>th (j-c)</sub>	Thermal resistance	Junction to case *3	—	—	3.0	°C/W	
(dv/dt) <sub>c</sub>	Critical-rate of rise of off-state commutating voltage *4	T <sub>j</sub> =125°C/150°C	10/1	—	—	V/μs	

\*2. Measurement using the gate trigger characteristics measurement circuit.

\*3. The contact thermal resistance R<sub>th (c-f)</sub> in case of greasing is 0.5°C/W.

\*4. Test conditions of the critical-rate of rise of off-state commutating voltage is shown in the table below.

Test conditions	Commutating voltage and current waveforms (inductive load)
1. Junction temperature T <sub>j</sub> =125°C/150°C  2. Rate of decay of on-state commutating current (di/dt) <sub>c</sub> =-8.0A/ms  3. Peak off-state voltage V <sub>D</sub> =400V	

## PERFORMANCE CURVES

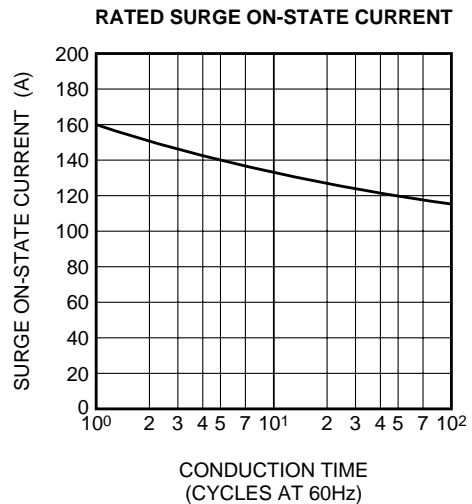
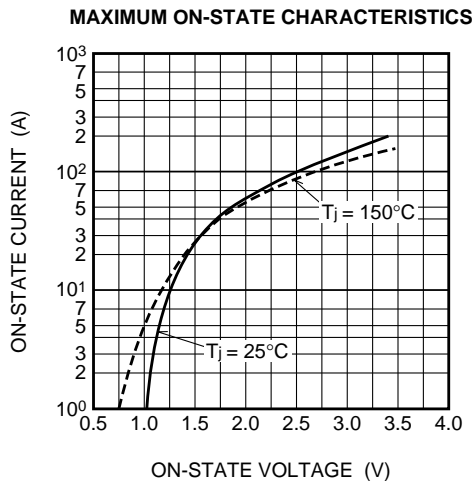

# BCR16PM

The product guaranteed maximum junction temperature 150°C (See warning.)

MEDIUM POWER USE  
INSULATED TYPE, PLANAR PASSIVATION TYPE

**GATE CHARACTERISTICS  
(I, II AND III)**

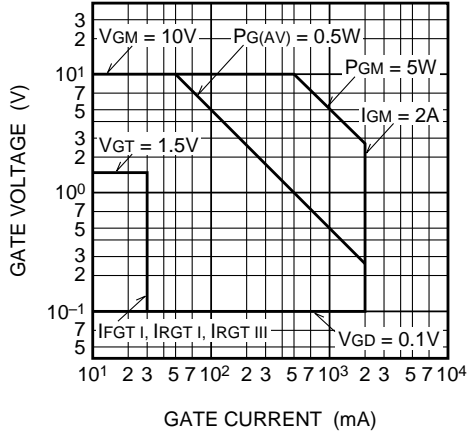

**GATE TRIGGER CURRENT VS. JUNCTION TEMPERATURE**

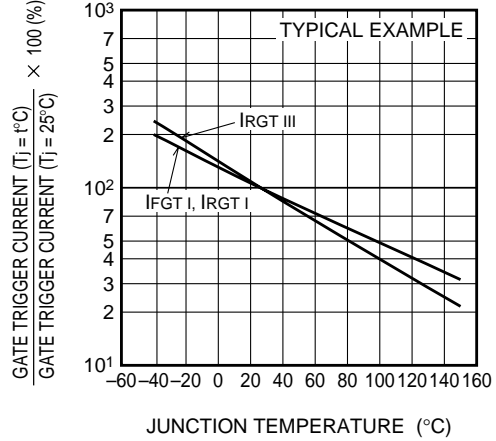

**GATE TRIGGER VOLTAGE VS. JUNCTION TEMPERATURE**

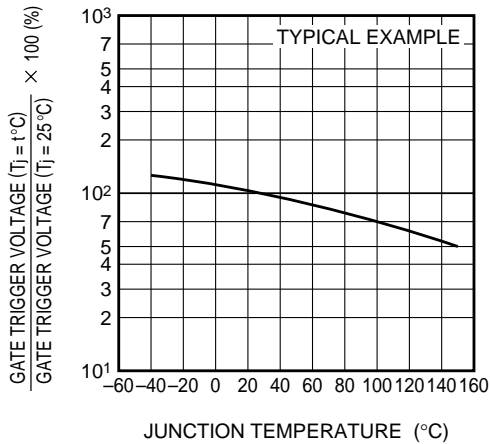

**MAXIMUM TRANSIENT THERMAL IMPEDANCE CHARACTERISTICS (JUNCTION TO CASE)**

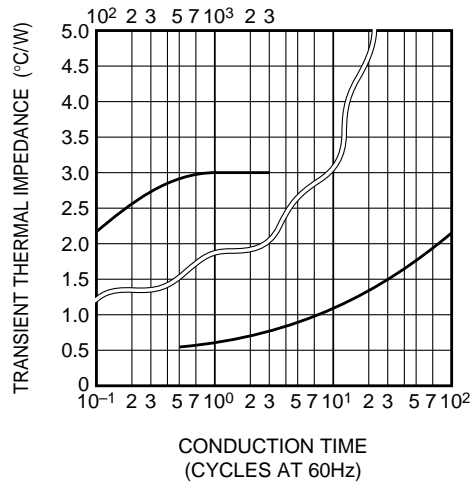

**MAXIMUM TRANSIENT THERMAL IMPEDANCE CHARACTERISTICS (JUNCTION TO AMBIENT)**

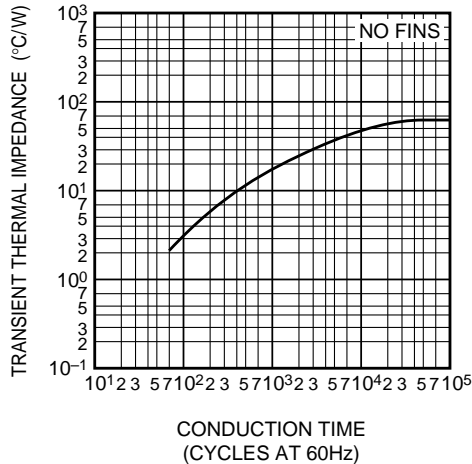

**MAXIMUM ON-STATE POWER DISSIPATION**

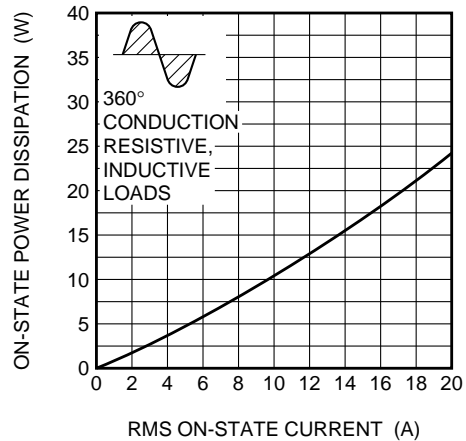

**BCR16PM**

The product guaranteed maximum junction temperature 150°C (See warning.)

**MEDIUM POWER USE**  
**INSULATED TYPE, PLANAR PASSIVATION TYPE**

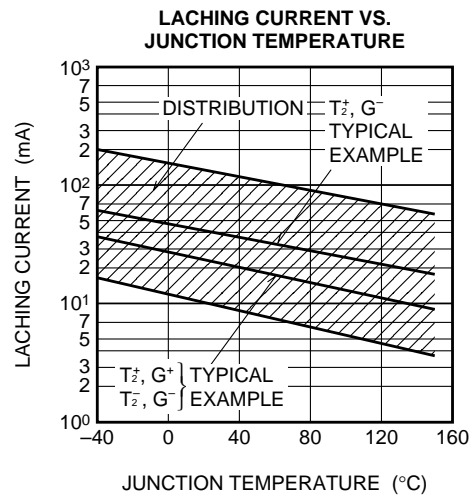
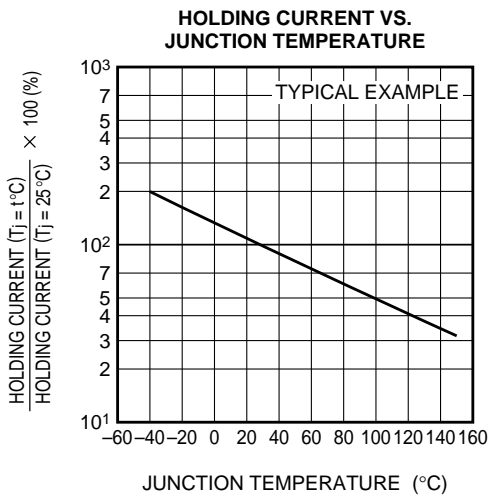
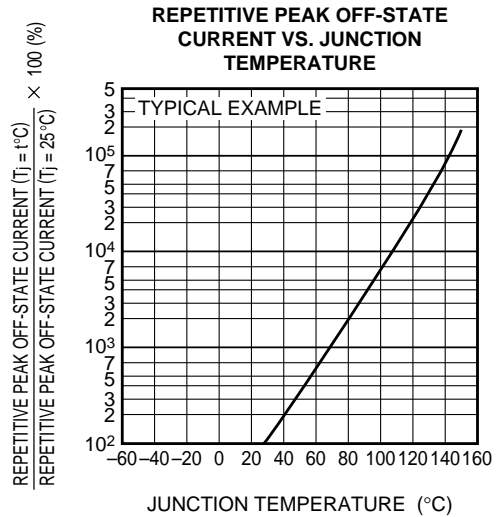
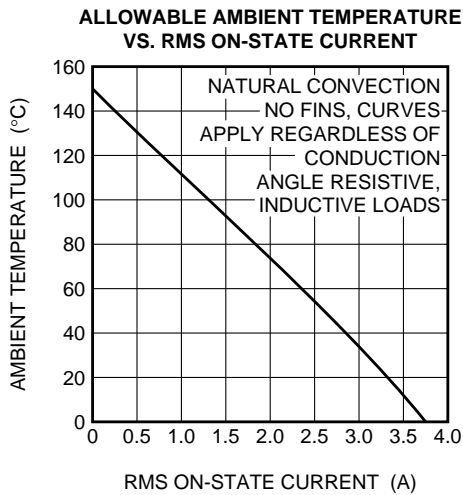
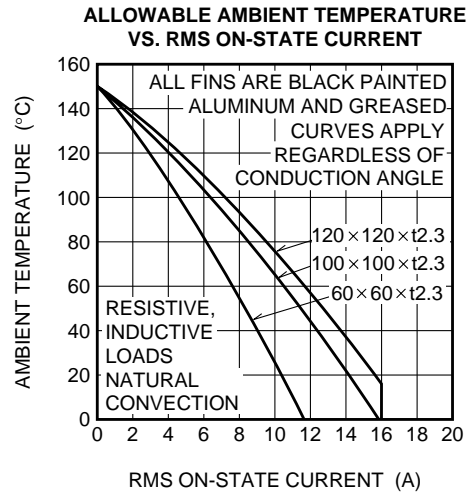
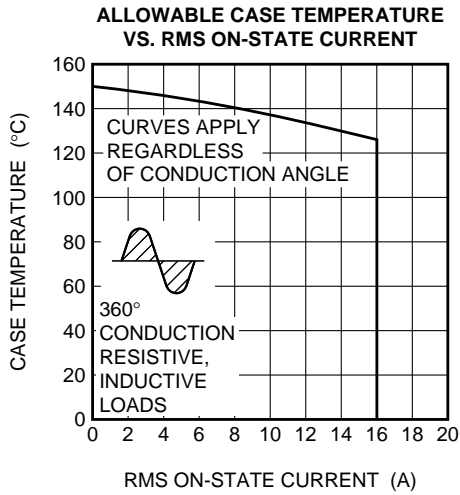

**BCR16PM**

The product guaranteed maximum junction temperature 150°C (See warning.)

**MEDIUM POWER USE**  
**INSULATED TYPE, PLANAR PASSIVATION TYPE**

**BREAKOVER VOLTAGE VS. JUNCTION TEMPERATURE**

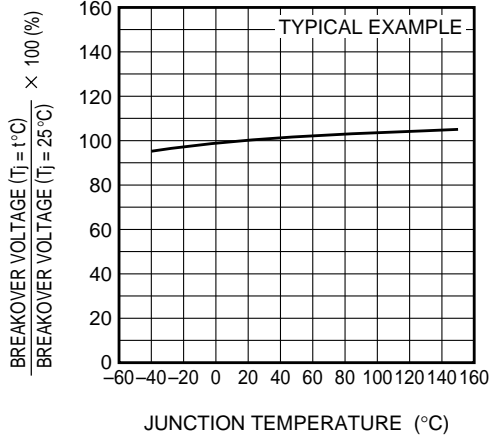

**BREAKOVER VOLTAGE VS. RATE OF RISE OF OFF-STATE VOLTAGE (Tj = 125°C)**

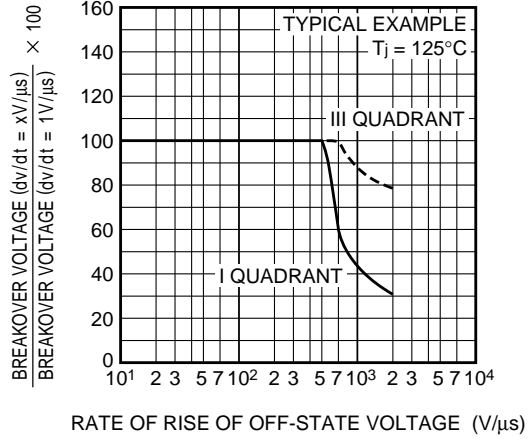

**BREAKOVER VOLTAGE VS. RATE OF RISE OF OFF-STATE VOLTAGE (Tj = 150°C)**

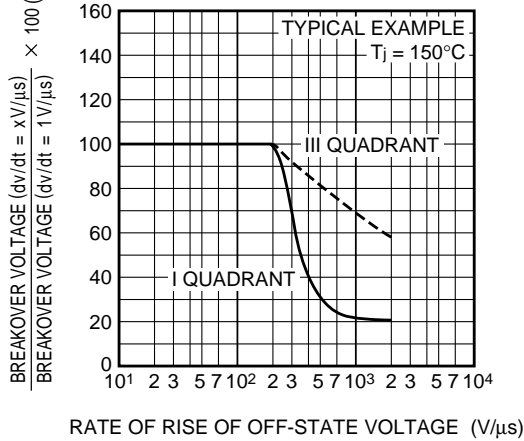

**COMMUTATION CHARACTERISTICS (Tj = 125°C)**

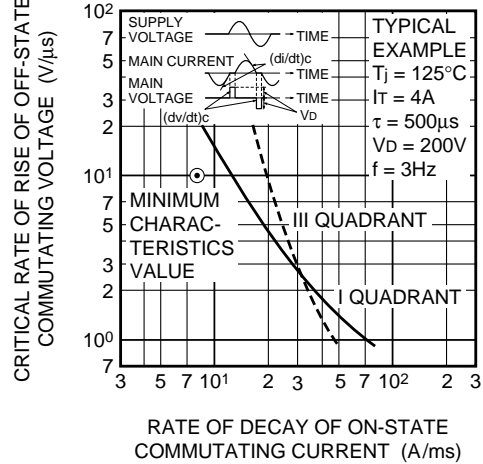

**COMMUTATION CHARACTERISTICS (Tj = 150°C)**

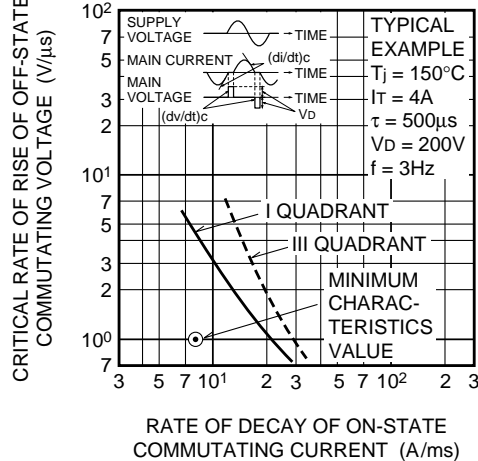

**GATE TRIGGER CURRENT VS. GATE CURRENT PULSE WIDTH**

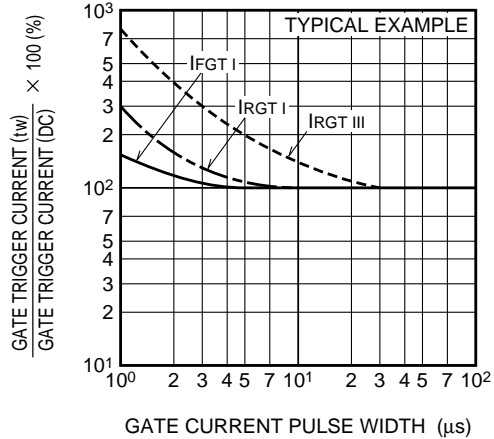

# BCR16PM

The product guaranteed maximum junction temperature 150°C (See warning.)

**MEDIUM POWER USE**  
**INSULATED TYPE, PLANAR PASSIVATION TYPE**

**GATE TRIGGER CHARACTERISTICS TEST CIRCUITS**

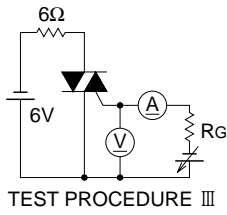
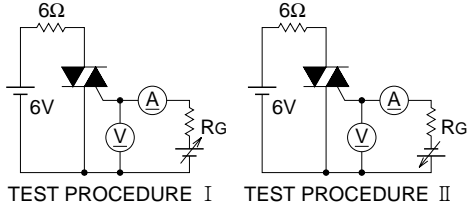

**RECOMMENDED CIRCUIT VALUES AROUND THE TRIAC**

