

MITSUBISHI Nch POWER MOSFET

FY10AAJ-03A

HIGH-SPEED SWITCHING USE

FY10AAJ-03A

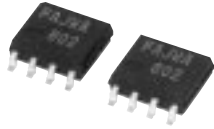

- 4V DRIVE
- V_{DSS} 30V
- r_{DS (ON)} (MAX) 13.5mΩ
- I_D 10A

OUTLINE DRAWING

Dimensions in mm

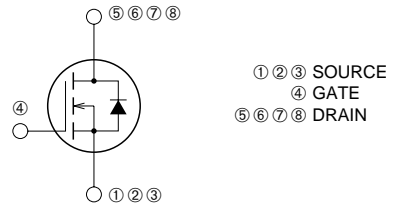
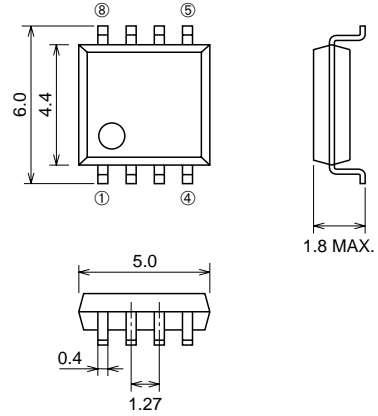

SOP-8

APPLICATION

Motor control, Lamp control, Solenoid control
DC-DC converter, etc.

MAXIMUM RATINGS (T_c = 25°C)

Symbol	Parameter	Conditions	Ratings	Unit
V _{DSS}	Drain-source voltage	V _{GS} = 0V	30	V
V _{GSS}	Gate-source voltage	V _{DS} = 0V	±20	V
I _D	Drain current		10	A
I _{DM}	Drain current (Pulsed)		70	A
I _{DA}	Avalanche drain current (Pulsed)	L = 10μH	10	A
I _S	Source current		2.3	A
I _{SM}	Source current (Pulsed)		9.2	A
P _D	Maximum power dissipation		2.0	W
T _{ch}	Channel temperature		-55 ~ +150	°C
T _{stg}	Storage temperature		-55 ~ +150	°C
—	Weight	Typical value	0.07	g

Sep.1998

ELECTRICAL CHARACTERISTICS (Tch = 25°C)

Symbol	Parameter	Test conditions	Limits			Unit
			Min.	Typ.	Max.	
V(BR)DSS	Drain-source breakdown voltage	Id = 1mA, VGS = 0V	30	—	—	V
IGSS	Gate-source leakage current	VGS = ±20V, VDS = 0V	—	—	±0.1	μA
IDSS	Drain-source leakage current	VDS = 30V, VGS = 0V	—	—	0.1	mA
VGS(th)	Gate-source threshold voltage	Id = 1mA, VDS = 10V	1.0	1.5	2.0	V
rDS(ON)	Drain-source on-state resistance	Id = 10A, VGS = 10V	—	9.5	13.5	mΩ
rDS(ON)	Drain-source on-state resistance	Id = 5A, VGS = 4V	—	15	20.0	mΩ
VDS(ON)	Drain-source on-state voltage	Id = 10A, VGS = 10V	—	0.095	0.135	V
yfs	Forward transfer admittance	Id = 10A, VDS = 10V	—	20	—	S
Ciss	Input capacitance	VDS = 10V, VGS = 0V, f = 1MHz	—	1800	—	pF
Coss	Output capacitance		—	650	—	pF
Crss	Reverse transfer capacitance		—	280	—	pF
td(on)	Turn-on delay time	VDD = 15V, Id = 5A, VGS = 10V, RGEN = RGS = 50Ω	—	25	—	ns
tr	Rise time		—	45	—	ns
td(off)	Turn-off delay time		—	125	—	ns
tf	Fall time		—	90	—	ns
VSD	Source-drain voltage	IS = 2.3A, VGS = 0V	—	0.75	1.10	V
Rth(ch-a)	Thermal resistance	Channel to ambient	—	—	62.5	°C/W
trr	Reverse recovery time	IS = 2.3A, dis/dt = -50A/μs	—	45	—	ns

PERFORMANCE CURVES

POWER DISSIPATION DERATING CURVE

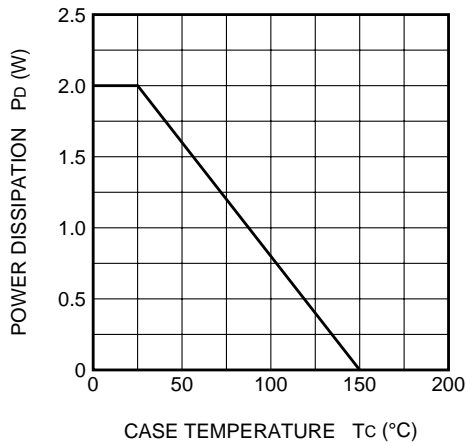

MAXIMUM SAFE OPERATING AREA

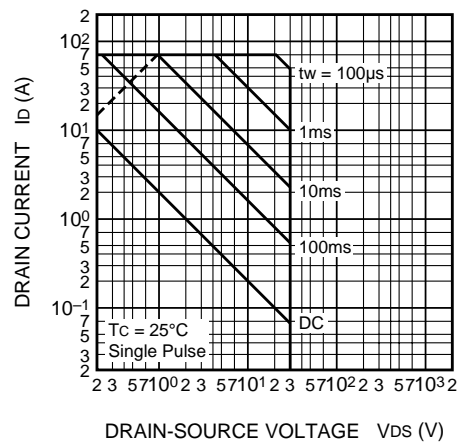

OUTPUT CHARACTERISTICS (TYPICAL)

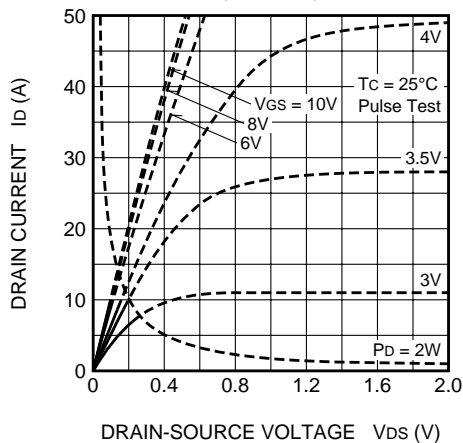

OUTPUT CHARACTERISTICS (TYPICAL)

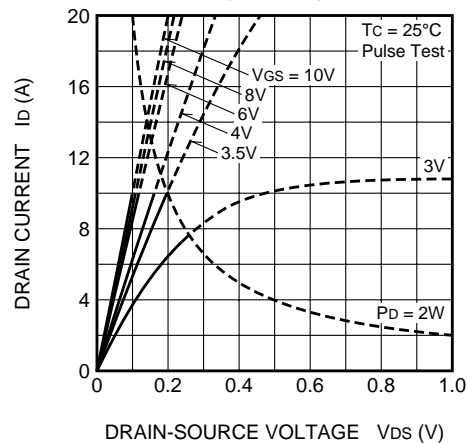

ON-STATE VOLTAGE VS. GATE-SOURCE VOLTAGE (TYPICAL)

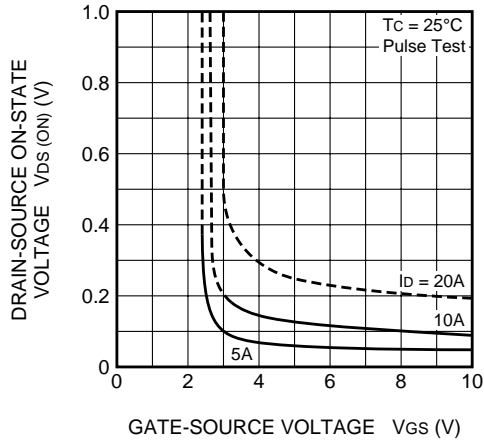

ON-STATE RESISTANCE VS. DRAIN CURRENT (TYPICAL)

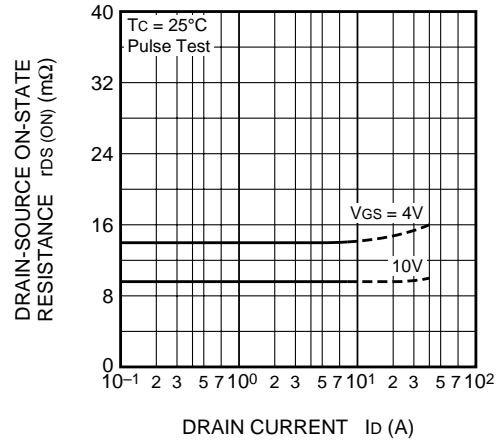

TRANSFER CHARACTERISTICS (TYPICAL)

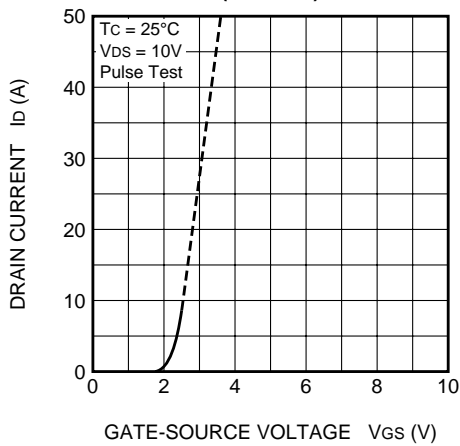

FORWARD TRANSFER ADMITTANCE VS. DRAIN CURRENT (TYPICAL)

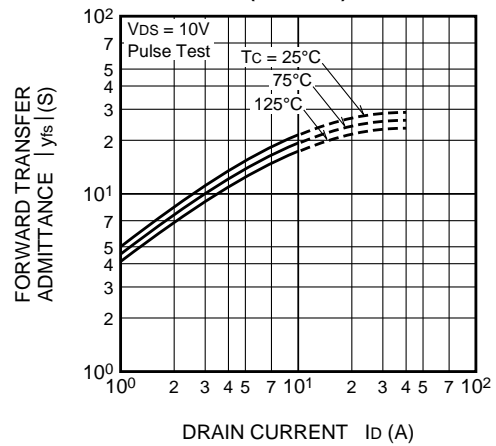

CAPACITANCE VS. DRAIN-SOURCE VOLTAGE (TYPICAL)

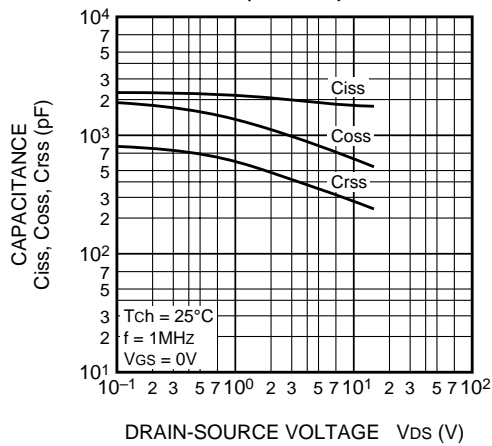

SWITCHING CHARACTERISTICS (TYPICAL)

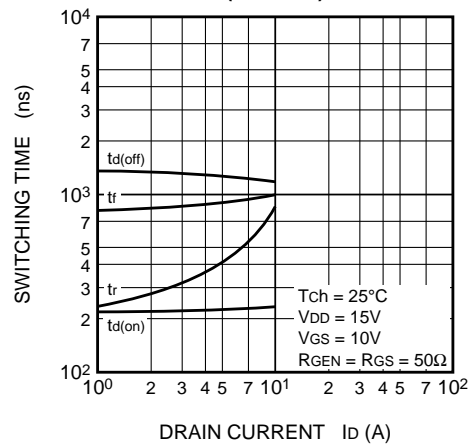

GATE-SOURCE VOLTAGE VS. GATE CHARGE (TYPICAL)

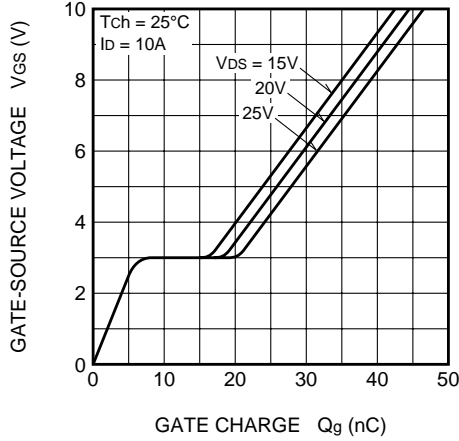

SOURCE-DRAIN DIODE FORWARD CHARACTERISTICS (TYPICAL)

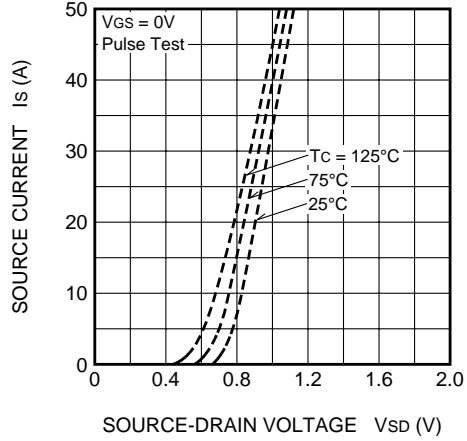

ON-STATE RESISTANCE VS. CHANNEL TEMPERATURE (TYPICAL)

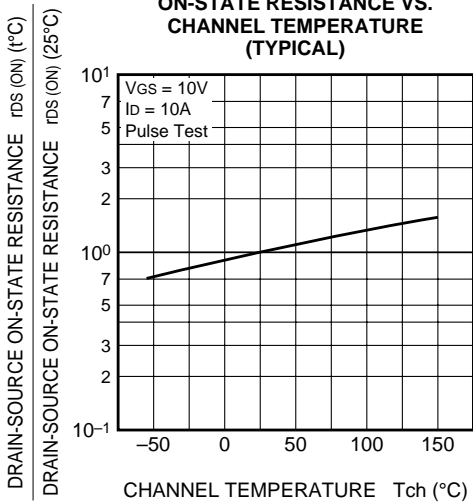

THRESHOLD VOLTAGE VS. CHANNEL TEMPERATURE (TYPICAL)

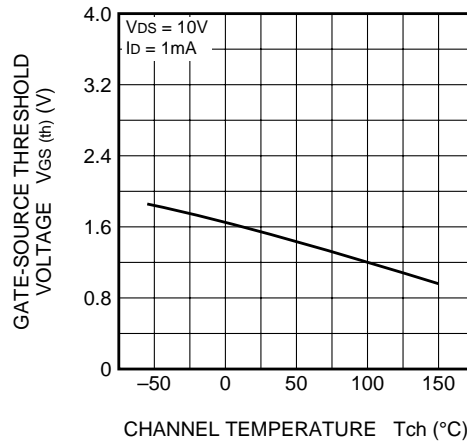

BREAKDOWN VOLTAGE VS. CHANNEL TEMPERATURE (TYPICAL)

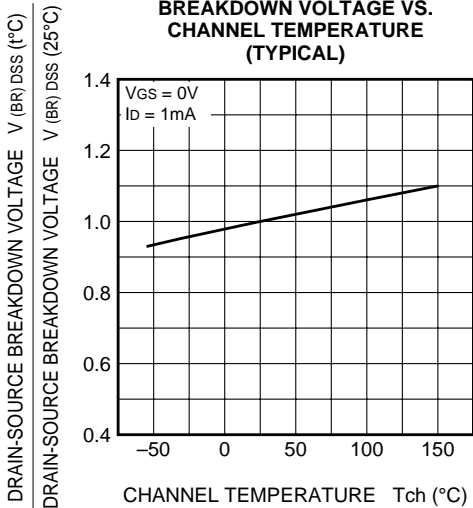

TRANSIENT THERMAL IMPEDANCE CHARACTERISTICS

