

Thyristor Product Catalog

Teccor Electronics
1800 Hurd Drive
Irving, Texas 75038
United States of America

Phone: +1 972-580-7777
Fax: +1 972-550-1309
Website: <http://www.teccor.com>
E-mail: power.techsales@teccor.com

Teccor Electronics reserves the right to make changes at any time in order to improve designs and to supply the best products possible. The information in this catalog has been carefully checked and is believed to be accurate and reliable; however, no liability of any type shall be incurred by Teccor for the use of the circuits or devices described in this publication. Furthermore, no license of any patent rights is implied or given to any purchaser.

Teccor Electronics is the proprietor of the QUADRAC® trademark.  is a registered trademark of Underwriters Laboratories, Inc. All other brand names may be trademarks of their respective companies. To conserve space in this catalog, the trademark sign (®) is omitted.

Contents

Product Selection Guide	
Product Descriptions - - - - -	vi
Circuit Requirement Diagram - - - - -	vii
Product Packages - - - - -	viii
Description of Part Numbers - - - - -	x
Quality and Reliability Assurance - - - - -	xii
Standard Terms and Conditions - - - - -	xiv
Data Sheets	
V-I Characteristics of Thyristor Devices - - - - -	E0-2
Electrical Parameter Terminology - - - - -	E0-3
Electrical Specifications	
Sensitive Triacs - - - - -	E1
Triacs - - - - -	E2
QUADRACs - - - - -	E3
Alternistor Triacs - - - - -	E4
Sensitive SCRs - - - - -	E5
SCRs - - - - -	E6
Rectifiers - - - - -	E7
Diacs - - - - -	E8
SIDAC - - - - -	E9
Mechanical Specifications	
Package Dimensions - - - - -	M1
Lead Form Dimensions - - - - -	M2
Packing Options - - - - -	M3
Application Notes	
Fundamental Characteristics of Thyristors - - - - -	AN1001
Gating, Latching, and Holding of SCRs and Triacs - - - - -	AN1002
Phase Control Using Thyristors - - - - -	AN1003
Mounting and Handling of Semiconductor Devices - - - - -	AN1004
Surface Mount Soldering Recommendations - - - - -	AN1005
Testing Teccor Semiconductor Devices	
Using Curve Tracers - - - - -	AN1006
Thyristors Used As AC Static Switches and Relays - - - - -	AN1007
Explanation of Maximum Ratings and Characteristics for Thyristors -	AN1008
Miscellaneous Design Tips and Facts - - - - -	AN1009
Thyristors for Ignition of Fluorescent Lamps - - - - -	AN1010
Appendix	
Cross Reference Guide - - - - -	A1
Part Numbers Index - - - - -	A27

Product Selection Guide

Product Descriptions	P 2
Circuit Requirement Diagram	P 3
Product Packages	P 4
Description of Part Numbers.....	P 6
Quality and Reliability Assurance	P 8
Standard Terms and Conditions	P 10

Product Descriptions

Thyristors

A thyristor is any semiconductor switch with a bi-stable action depending on p-n-p-n regenerative feedback. Thyristors are normally two- or three-terminal devices for either unidirectional or bidirectional circuit configurations. Thyristors can have many forms, but they have certain commonalities. All thyristors are solid state switches that are normally open circuits (very high impedance), capable of withstanding rated blocking/off-state voltage until triggered to on state. When triggered to on state, thyristors become a low-impedance current path until principle current either stops or drops below a minimum holding level. After a thyristor is triggered to on-state condition, the trigger current can be removed without turning off the device. Thyristors are used to control the flow of electrical currents in applications including:

- Home appliances (lighting, heating, temperature control, alarm activation, fan speed)
- Electrical tools (for controlled actions such as motor speed, stapling event, battery charging)
- Outdoor equipment (water sprinklers, gas engine ignition, electronic displays, area lighting, sports equipment, physical fitness)

Sensitive Triacs

Teccor's sensitive gate triacs are AC bidirectional silicon switches that provide guaranteed gate trigger current levels in Quadrants I, II, III, and IV. Interfacing to microprocessors or other equipment with single polarity gate triggering is made possible with sensitive gate triacs. Gate triggering currents of 3 mA, 5 mA, 10 mA, or 20 mA may be specified.

Sensitive gate triacs are capable of controlling AC load currents from 0.8 A to 8 A rms and can withstand operating voltages from 200 V to 600 V.

Triacs

Teccor's triac products are bidirectional AC switches, capable of controlling loads from 0.8 A to 35 A rms with 10 mA, 25 mA, and 50 mA I_{GT} in operating Quadrants I, II and III.

Triacs are useful in full-wave AC applications to control AC power either through full-cycle switching or phase control of current to the load element. These triacs are rated to block voltage in the "OFF" condition from 200 V minimum with selected products capable of 1000 V operation. Typical applications include motor speed controls, heater controls, and incandescent light controls.

Quadrac

Quadrac devices, originally developed by Teccor, are triacs and alternistor triacs with a diac trigger mounted inside the same package. These devices save the user the expense and assembly time of buying a discrete diac and assembling in conjunction with a gated triac.

The *Quadrac* is offered in capacities from 4 A to 15 A rms and voltages from 200 V ac to 600 V ac.

Alternistor Triacs

The Teccor alternistor is specifically designed for applications required to switch highly inductive loads. The design of this special chip effectively offers the same performance as two thyristors (SCRs) wired inverse parallel (back-to-back).

This new chip construction provides the equivalent of two electrically-separate SCR structures, providing enhanced dv/dt characteristics while retaining the advantages of a single-chip device.

Teccor manufactures 6 A to 40 A alternistors with blocking voltage rating from 200 V to 1000 V. Alternistors are offered in TO-220, TO-218, and TO-218X packages with isolated and non-isolated versions.

Sensitive SCRs

Teccor's sensitive gate SCRs are silicon-controlled rectifiers representing the best in design, performance, and packaging techniques for low- and medium-current applications.

Anode currents of 0.8 A to 10 A rms can be controlled by sensitive gate SCRs with gate drive currents ranging from 12 μ A to 500 μ A. Sensitive gate SCRs are ideally suited for interfacing to integrated circuits or in applications where high current load requirements and limited gate drive current capabilities exist. Examples include ignition circuits, motor controls, and DC latching for alarms in smoke detectors. Sensitive gate SCRs are available in voltage ratings to 600 V ac.

SCRs

Teccor's SCR products are half-wave, silicon-controlled rectifiers that represent the state of the art in design and performance.

Load current capabilities range from 1 A to 70 A rms, and voltages from 200 V to 1000 V may be specified to meet a variety of application needs.

Because of its unidirectional switching capability, the SCR is used in circuits where high surge currents or latching action is required. It may also be used for half-wave-type circuits where gate-controlled rectification action is required. Applications include crowbars in power supplies, camera flash units, smoke alarms, motor controls, battery chargers, and engine ignition.

Surge current ratings are available from 30 A in the TO-92 packaging to 950 A in the TO-218X package.

Rectifiers

Teccor manufactures 15 A to 25 A rms rectifiers with voltages rated from 200 V to 1000 V. Due to the electrically isolated TO-220 package, these rectifiers may be used in common anode or common cathode circuits using only one part type, thereby simplifying stock requirements.

Diacs

Diacs are trigger devices used in phase control circuits to provide gate pulses to a triac or SCR. They are voltage-triggered bidirectional silicon devices housed in DO-35 glass axial lead packages and DO-214 surface mount packages.

Diac voltage selections from 27 V to 45 V provide trigger pulses closely matched in symmetry at the positive and negative break-over points to minimize DC component in the load circuit.

Some applications include gate triggers for light controls, dimmers, power pulse circuits, voltage references in AC power circuits, and triac triggers in motor speed controls.

Sidacs



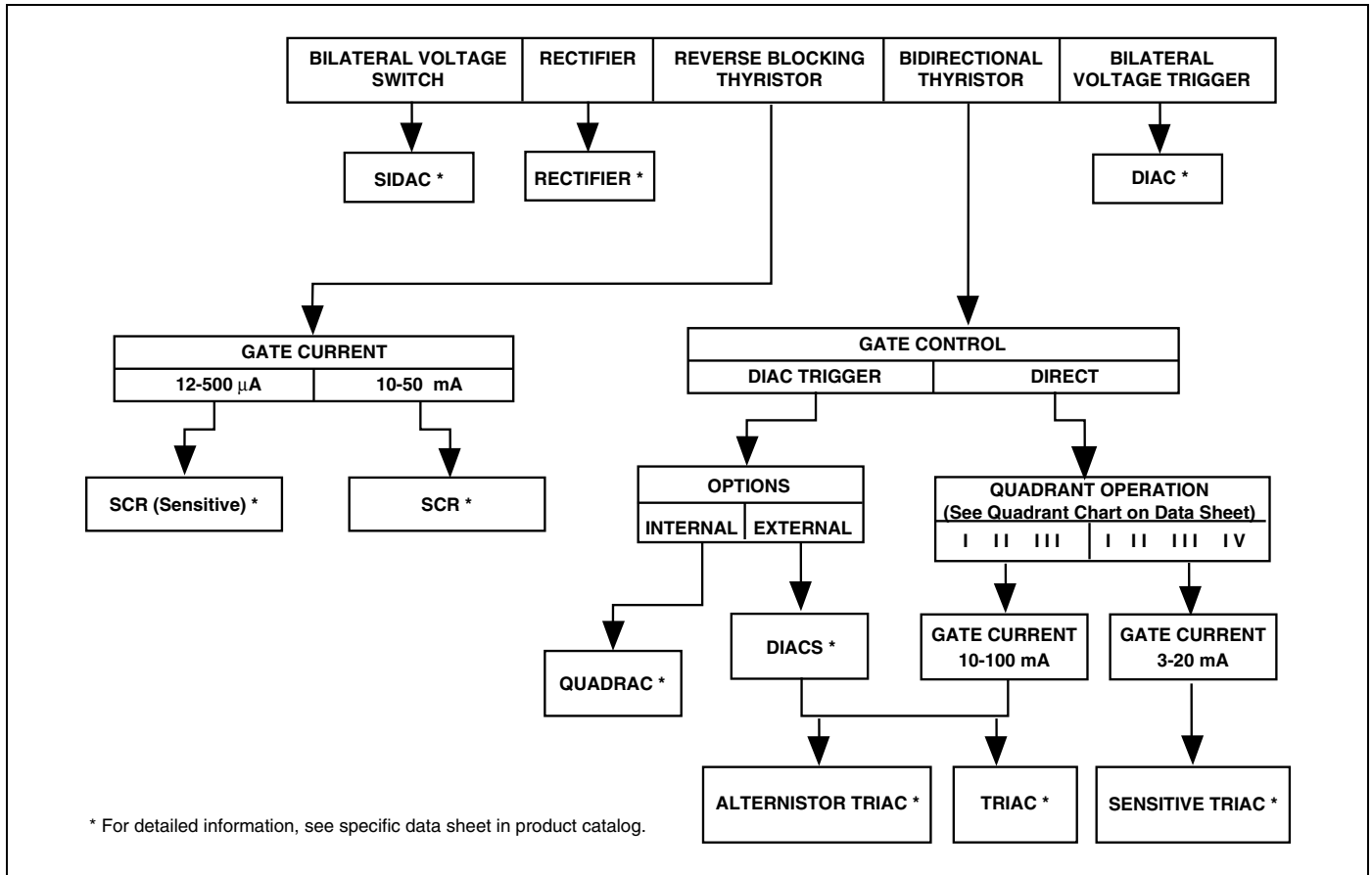

Sidacs represent a unique set of thyristor qualities. The sidac is a bidirectional voltage triggered switch. Some characteristics of this device include a normal 95 V to 330 V switching point, negative resistance range, latching characteristics at turn-on, and a low on-state voltage drop.

One-cycle surge current capability up to 20 A makes the sidac an ideal product for dumping charged capacitors through an inductor in order to generate high-voltage pulses. Applications include light controls, high-pressure sodium lamp starters, power oscillators, and high-voltage power supplies.

Circuit Requirement Diagram

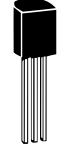
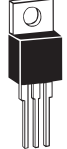
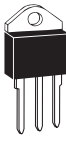
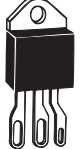
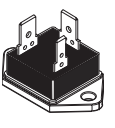

Product Packages

Package Code							Isolated Mounting Tab			
		G	Y	S	C	E	L	K	J	P
Product Type	Current (Amps)									
		DO-15	DO-35	DO-214	Compak	TO-92 *	TO-220	TO-218	TO-218X	TO-3 Fastpak
Sensitive Triac	0.8				✓	✓				
	1				✓	✓				
	4						✓			
	6						✓			
	8						✓			
Triac	0.8				✓	✓				
	1				✓	✓				
	4						✓			
	6						✓			
	8						✓			
	10						✓			
	15						✓			
	25									✓
	35									✓
Quadrac	4						✓			
	6						✓			
	8						✓			
	10						✓			
	15						✓			
Alternistor	6						✓			
	8						✓			
	10						✓			
	12						✓			
	16						✓			
	25						✓	✓	✓	
	30						✓			
	35									
	40							✓	✓	
Sensitive SCR	0.8				✓	✓				
	1.5					✓				
	4									
	6						✓			
	8						✓			
	10						✓			
SCR	1				✓	✓				
	6						✓			
	8						✓			
	10						✓			
	12						✓			
	15						✓			
	16									
	20						✓			
	25						✓			
	35							✓	✓	
	40									
	55									
65							✓	✓		
70										
Rectifier	15						✓			
	20						✓			
	25						✓			
Diac			✓	✓						
Sidac		✓		✓		✓*				

* No center lead on TO-92 Sidacs.

Product Packages

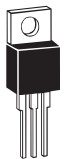
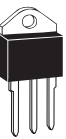
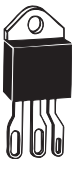
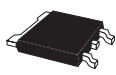
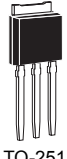
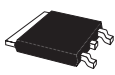
Non-isolated Mounting Tab							Package Code	
F	R	M	W	D	V	N	Current (Amps)	Product Type
								
TO-202	TO-220	TO-218	TO-218X	TO-252 D-Pak	TO-251 V-Pak	TO-263 D²Pak		
							0.8	Sensitive Triac
							1	
✓				✓	✓		4	
				✓	✓		6	
				✓	✓		8	
							0.8	Triac
							1	
✓				✓	✓		4	
✓	✓					✓	6	
✓	✓					✓	8	
✓	✓					✓	10	
	✓					✓	15	
	✓					✓	25	
	✓					✓	35	
							4	
							6	Quadrac
							8	
							10	
							15	
							4	
	✓			✓	✓	✓	6	Alternistor
	✓			✓	✓	✓	8	
	✓					✓	10	
	✓					✓	12	
	✓					✓	16	
	✓					✓	25	
	✓						30	
	✓						35	
	✓						40	
	✓						0.8	
	✓						1.5	Sensitive SCR
✓	✓			✓	✓		4	
✓	✓			✓	✓		6	
✓	✓			✓	✓		8	
✓	✓			✓	✓		10	
							1	SCR
✓				✓	✓		6	
✓	✓			✓	✓		8	
✓	✓			✓	✓		10	
	✓			✓	✓		12	
	✓						15	
	✓					✓	16	
	✓					✓	20	
	✓					✓	25	
	✓					✓	35	
	✓					✓	40	
	✓	✓	✓			✓	55	
			✓				65	
			✓				70	
							15	Rectifier
							20	
							25	
✓								Diac
								Sidac

Description of Part Numbers

Sensitive Triac

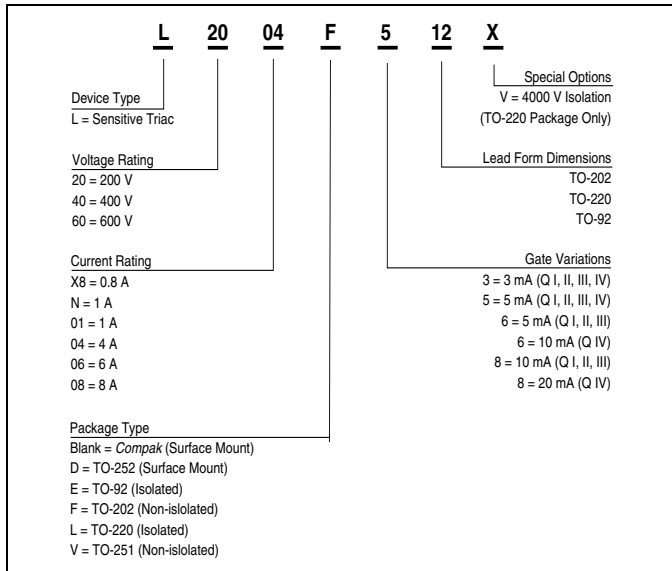

Triac and Alternistor

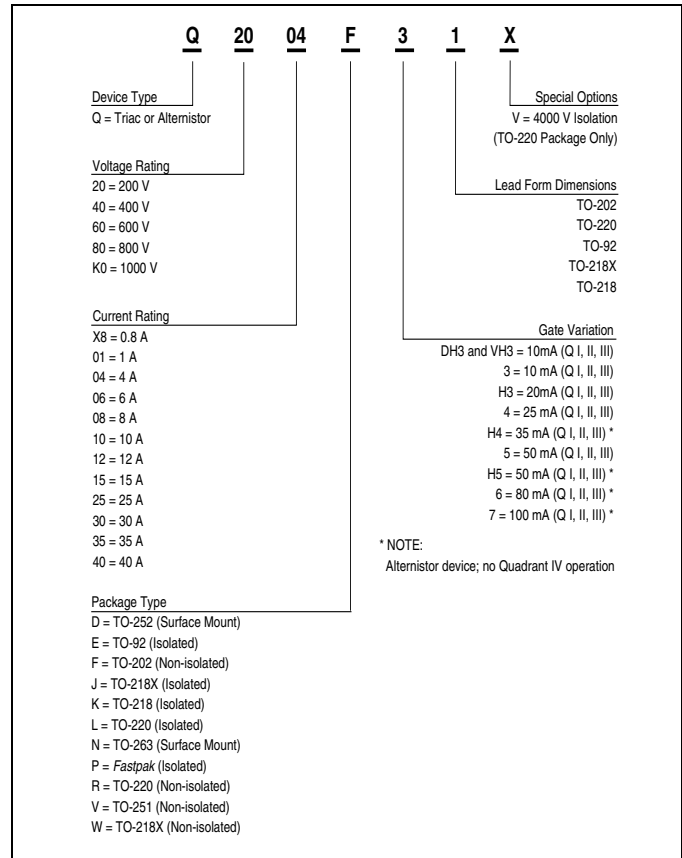

Quadrac

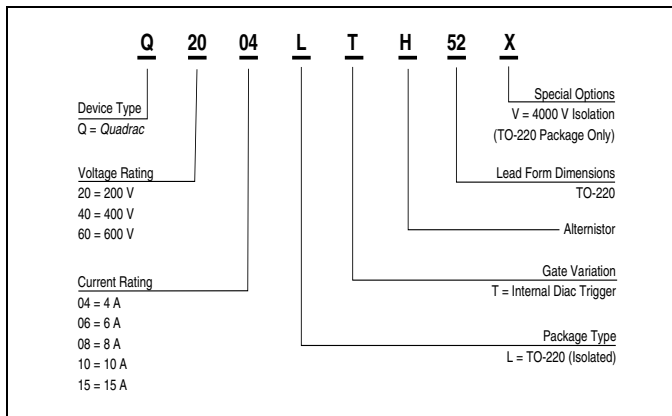

Sensitive SCR

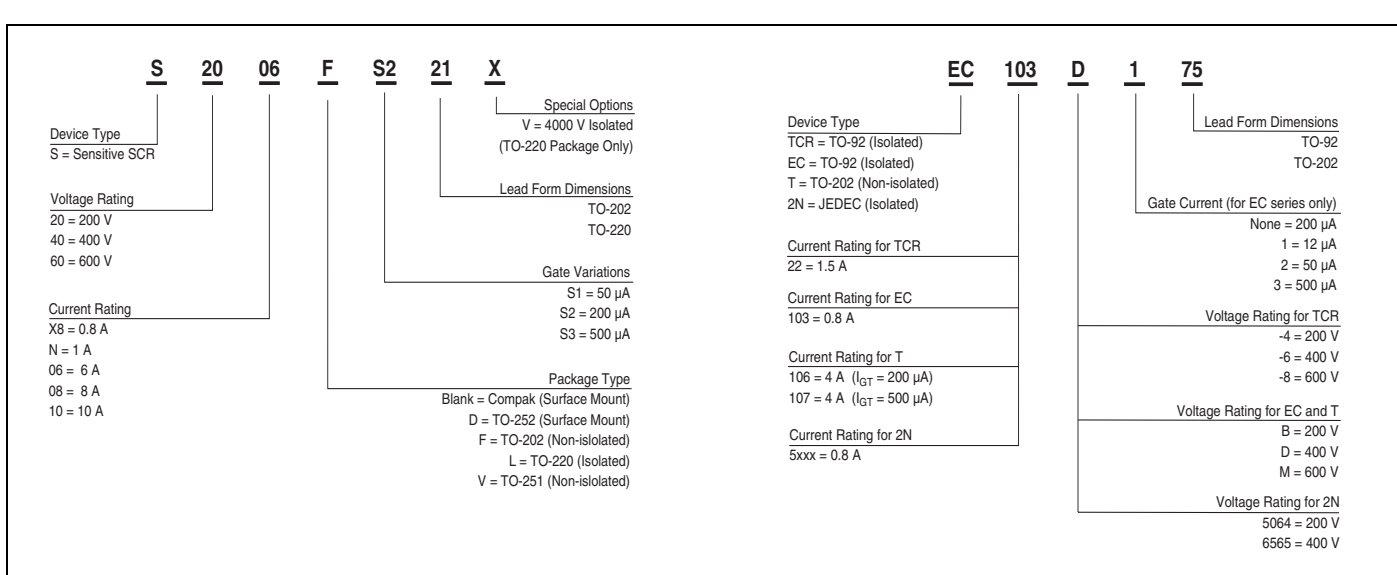

Description of Part Numbers

SCR

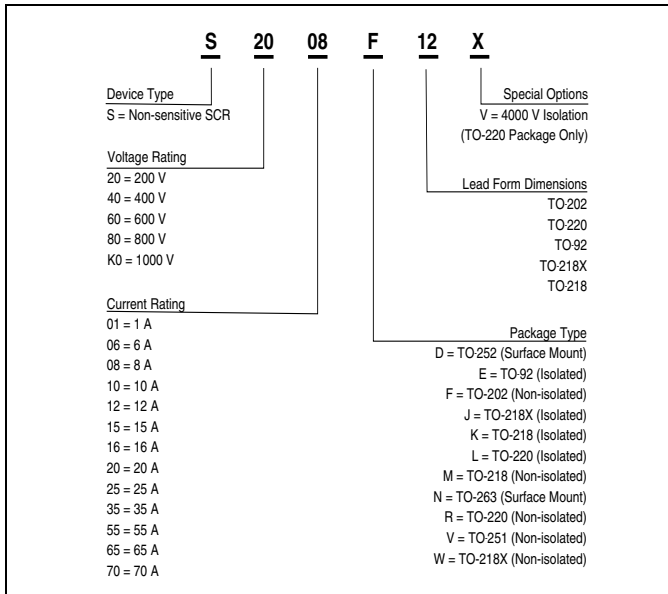

Sidac

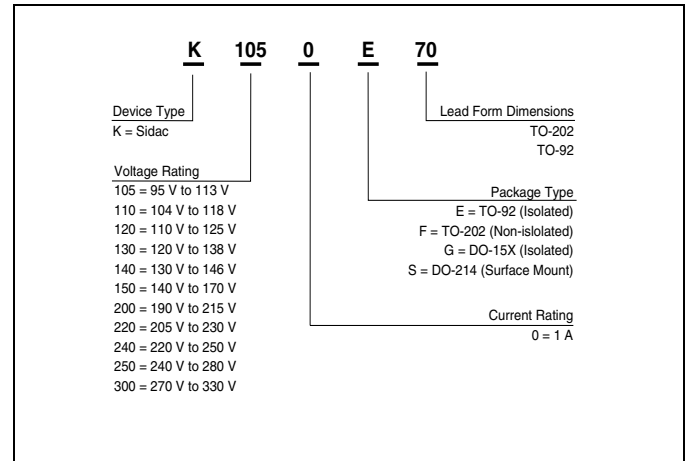

Rectifier

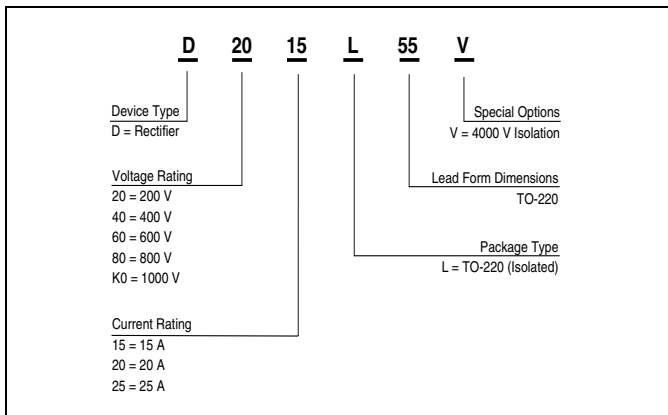

Diac

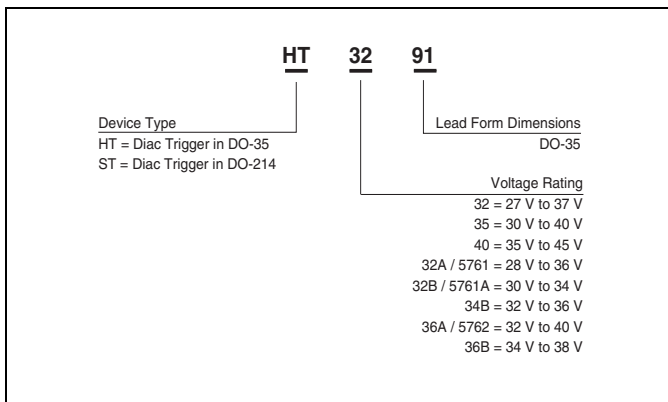

Quality and Reliability

It is Teccor's policy to ship quality products on time. We accomplish this through Total Quality Management based on the fundamentals of customer focus, continuous improvement, and people involvement.

In support of this commitment, Teccor applies the following principles:

- Employees shall be respected, involved, informed, and qualified for their job with appropriate education, training, and experience.
- Customer expectations shall be met or exceeded by consistently shipping products that meet the agreed specifications, quality levels, quantities, schedules, and test and reliability parameters.
- Suppliers shall be selected by considering quality, service, delivery, and cost of ownership.
- Design of products and processes will be driven by customer needs, reliability, and manufacturability.

It is the responsibility of management to incorporate these principles into policies and systems.

It is the responsibility of those in leadership roles to coach their people and to reinforce these principles.

It is the responsibility of each individual employee to follow the spirit of this statement to ensure that we meet the primary policy — to ship quality products on time.

Quality Assurance

Incoming Material Quality

Teccor "Vendor Analysis" programs provide stringent requirements before components are delivered to Teccor. In addition, purchased materials are tested rigidly at incoming inspection for specification compliance prior to acceptance for use.

Process Controls

From silicon slice input through final testing, we use statistical methods to control all critical processes. Process audits and lot inspections are performed routinely at all stages of the manufacturing cycle.

Parametric Testing

All devices are 100% computer tested for specific electrical characteristics at critical processing points.

Final Inspection

Each completed manufacturing lot is sampled and tested for compliance with electrical and mechanical requirements.

Reliability Testing

Random samples are taken from various product families for ongoing reliability testing.

Finished Goods Inspection

Product assurance inspection is performed immediately prior to shipping.

Design Assurance

The design and production of Teccor devices is a demanding and challenging task. Disciplined skills coupled with advanced computer-aided design, production techniques, and test equipment are essential elements in Teccor's ability to meet your demands for the very highest levels of quality.

All products must first undergo rigid quality design reviews and pass extensive environmental life testing. Teccor uses Statistical Process Control (SPC) with associated control charts throughout to monitor the manufacturing processes.

Only those products which pass tests designed to assure Teccor's high quality and reliability standards, while economically satisfying customer requirements, are approved for shipment. All new products and materials must receive approval of QRA prior to being released to production.

The combination of reliability testing, process controls, and lot tracking assures the quality and reliability of Teccor's devices. Since even the best control systems cannot overcome measurement limitations, Teccor designs and manufactures its own computerized test equipment.

Teccor's Reliability Engineering Group conducts ongoing product reliability testing to further confirm the design and manufacturing parameters.

Reliability Stress Tests

The following table contains brief descriptions of the reliability tests commonly used in evaluating Teccor product reliability on a periodic basis. These tests are applied across product lines depending on product availability and test equipment capacities. Other tests may be performed when appropriate.

Test Type	Typical Conditions	Test Description	Standards
High Temperature AC Blocking	$T_A = 100\text{ }^{\circ}\text{C}$ to $150\text{ }^{\circ}\text{C}$, Bias @ 100% Rated V_{DRM} , $t = 24\text{ hrs}$ to 1000 hrs	Evaluation of the reliability of product under bias conditions and elevated temperature	MIL-STD-750, M-1040
High Temperature Storage Life	$T_A = 150\text{ }^{\circ}\text{C}$, $t = 250$ to 1000 hrs	Evaluation of the effects on devices after long periods of storage at high temperature	MIL-STD-750, M-1031
Temperature and Humidity Bias Life	$T_A = 85\text{ }^{\circ}\text{C}$ to $95\text{ }^{\circ}\text{C}$, $rh = 85\%$ to 95% Bias @ 80% Rated V_{DRM} (320 VDC max) $t = 168$ to 1008 hrs	Evaluation of the reliability of non-hermetic packaged devices in humid environments	EIA / JEDEC, JESD22-A101
Temperature Cycle [Air to Air]	$T_A = -65\text{ }^{\circ}\text{C}$ to $150\text{ }^{\circ}\text{C}$, cycles = 10 to 500	Evaluation of the device's ability to withstand the exposure to extreme temperatures and the forces of TCE during transitions between temperatures	MIL-STD-750, M-1051, EIA / JEDEC, JESD22-A104
Thermal Shock [Liquid to Liquid]	$T_A = 0\text{ }^{\circ}\text{C}$ to $100\text{ }^{\circ}\text{C}$, $t_{\text{txfr}} = \leq 10\text{ s}$, cycled = 10 to 20	Evaluation of the device's ability to withstand the sudden changes in temperature and exposure to extreme temperatures	MIL-STD-750, M-1056
Autoclave	$T_A = 121\text{ }^{\circ}\text{C}$, $rh = 100\%$, $P = 15\text{ psig}$, $t = 24\text{ hrs}$ to 168 hrs	Accelerated environmental test to evaluate the moisture resistance of plastic packages	EIA / JEDEC, JESD22-A102
Resistance to Solder Heat	$T_A = 260\text{ }^{\circ}\text{C}$, $t = 10\text{ s}$	Evaluation of the device's ability to withstand the temperatures as seen in wave soldering operations	MIL-STD-750, M-2031
Solderability	Steam aging = 1 hr to 8 hrs, $T_{\text{solder}} = 245\text{ }^{\circ}\text{C}$, Flux = R	Evaluation of the solderability of device terminals after an extended period	MIL-STD-750, M-2026, ANSI-J-STD-002

Flammability Test

For the UL 94V0 flammability test, all epoxies used in Teccor encapsulated devices are recognized by Underwriters Laboratories

Standard Terms and Conditions



Supplier shall not be bound by any term proposed by Buyer in the absence of written agreement to such term signed by an authorized officer of Supplier.

(1) PRICE:

- (A) Supplier reserves the right to change product prices at any time but, whenever practicable, Supplier will give Buyer at least thirty (30) days written notice before the effective date of any price change. Unless Supplier has specifically agreed in writing, signed by an authorized officer of Supplier, that a quoted price shall not be subject to change for a certain time, all products shipped on or after the effective date of a price change may be billed at the new price level.
- (B) Whenever Supplier agrees to a modification of Buyer's order (which modification must be in writing and signed by an authorized officer of Supplier), Supplier reserves the right to alter its price, whether or not such price was quoted as "firm."
- (C) Prices do not include federal, state or local taxes, now or hereafter enacted, applicable to the goods sold. Taxes will be added by Supplier to the sales prices whenever Supplier has legal obligation to collect them and will be paid by Buyer as invoiced unless Buyer provides Supplier with a proper tax exemption certificate.

(2) PRODUCTION: Supplier may, at its sole discretion and at any time, withdraw any catalog item from further production without notice or liability to Buyer.

(3) INTEREST:

- (A) All late payments shall bear interest thirty (30) days after the due date stated on the invoice until paid at the lower of one and one-half percent per month or the maximum rate permitted by law. All interest becoming due shall, if not paid when due, be added to principal and bear interest from the due date. At Supplier's option, any payment shall be applied first to interest and then to principal.
- (B) It is the intention of the parties to comply with the laws of the jurisdiction governing any agreement between the parties relating to interest. If any construction of the agreement between the parties indicates a different right given to Supplier to demand or receive any sum greater than that permissible by law as interest, such as a mistake in calculation or wording, this paragraph shall override. In any contingency which will cause the interest paid or agreed to be paid to exceed the maximum rate permitted by law, such excess will be applied to the reduction of any principal amount due, or if there is no principal amount due, shall be refunded.

(4) TITLE AND DELIVERY: Title to goods ordered by Buyer and risk of loss or damage in transit or thereafter shall pass to Buyer upon Supplier's delivery of the goods at Supplier's plant or to a common carrier for shipment to Buyer.

(5) CONTINGENCIES: Supplier shall not be responsible for any failure to perform due to causes reasonably beyond its control. These causes shall include, but not be restricted to, fire, storm, flood, earthquake, explosion, accident, acts of public enemy, war rebellion, insurrection, sabotage, epidemic, quarantine restrictions, labor disputes, labor shortages, labor slow downs and sit downs, transportation embargoes, failure or delays in transportation, inability to secure raw materials or machinery for the manufacture of its devices, acts of God, acts of the Federal Government or any agency thereof, acts of any state or local government or agency thereof, and judicial action. Similar causes shall excuse Buyer for failure to take goods ordered by Buyer, from the time Supplier receives written notice from Buyer and for as long as the disabling cause continues, other than for goods already in transit or specially fabricated and not readily saleable to other buyers.

Supplier assumes no responsibility for any tools, dies, and other equipment furnished Supplier by Buyer.

(6) LIMITED WARRANTY AND EXCLUSIVE REMEDY: Supplier warrants all catalog products to be free from defects in materials and workmanship under normal and proper use and application for a period of twelve (12) months from the date code on the product in question (or if none, from the date of delivery to Buyer.) With respect to products assembled, prepared, or manufactured to Buyer's specifications, Supplier warrants only that such products will meet Buyer's specifications upon delivery. As the party responsible for the specifications, Buyer shall be responsible for testing and inspecting the products for adherence to specifications, and Supplier shall have no liability in the absence of such testing and inspection or if the product passes such testing or inspection. THE ABOVE WARRANTY IS THE ONLY WARRANTY EXTENDED BY SUPPLIER, AND IS IN LIEU OF AND EXCLUDES ALL OTHER WARRANTIES AND CONDITIONS, EXPRESSED OR IMPLIED (EXCEPT AS PROVIDED HEREIN AS TO TITLE), ON ANY GOODS OR SERVICES SOLD OR RENDERED BY SUPPLIER, INCLUDING ANY IMPLIED WARRANTIES OF MERCHANTABILITY AND FITNESS FOR A PARTICULAR PURPOSE. THIS WARRANTY WILL NOT CREATE WARRANTY COVERAGE FOR ANY ITEM INTO WHICH ANY PRODUCT SOLD BY SUPPLIER MAY HAVE BEEN INCORPORATED OR ADDED.

Standard Terms and Conditions

SUPPLIER'S ENTIRE LIABILITY AND BUYER'S EXCLUSIVE REMEDY UNDER THIS WARRANTY SHALL BE, AT SUPPLIER'S OPTION, EITHER THE REPLACEMENT OF, REPAIR OF, OR ISSUANCE OF CREDIT TO BUYER'S ACCOUNT WITH SUPPLIER FOR ANY PRODUCTS WHICH ARE PROPERLY RETURNED BY BUYER DURING THE WARRANTY PERIOD. All returns must comply with the following conditions:

- (A) Supplier is to be promptly notified in writing upon discovery of defects by Buyer.
- (B) Buyer must obtain a Return Material Authorization (RMA) number from the Supplier prior to returning product.
- (C) The defective product is returned to Supplier, transportation charges prepaid by Buyer.
- (D) Supplier's examination of such product discloses, to its satisfaction, that such defects have not been caused by misuse, neglect, improper installation, repair, alteration, or accident.
- (E) The product is returned in the form it was delivered with any necessary disassembly carried out by Buyer at Buyer's expense.

IN NO EVENT SHALL SUPPLIER, OR ANYONE ELSE ASSOCIATED IN THE CREATION OF ANY OF SUPPLIER'S PRODUCTS OR SERVICES, BE LIABLE TO BUYER FOR INCIDENTAL OR CONSEQUENTIAL DAMAGES OF ANY NATURE INCLUDING LOSS OF PROFITS, LOSS OF USE, BUSINESS INTERRUPTION, AND THE LIKE. BUYER ACKNOWLEDGES THAT THE ABOVE WARRANTIES AND LIMITATIONS THEREON ARE APPROPRIATE AND REASONABLE IN EFFECTUATING SUPPLIER'S AND BUYER'S MUTUAL INTENTION TO CONDUCT AN EFFICIENT TRANSACTION AT PRICES MORE ADVANTAGEOUS TO BUYER THAN WOULD BE AVAILABLE IN THE PRESENCE OF OTHER WARRANTIES AND ASSURANCES.

- (7) PATENTS: Buyer shall notify Supplier in writing of any claim that any product or any part of use thereof furnished under this agreement constitutes an infringement of any U.S. patent, copyright, trade secret, or other proprietary rights of a third party. Notice shall be given within a reasonable period of time which should in most cases be within ten (10) days of receipt by Buyer of any letter, summons, or complaint pertaining to such a claim. At its option, Supplier may defend at its expense any action brought against Buyer to the extent that it is based on such a claim. Should Supplier choose to defend any such claim, Supplier may fully participate in the defense, settlement, or appeal of any action based on such claim.

Should any product become, or in Supplier's opinion be likely to become, the subject of an action based on any such claim, Supplier may, at its option, as the Buyer's exclusive remedy, either procure for the Buyer the right to continue using the product, replace the product or modify the product to make it noninfringing. IN NO EVENT SHALL SUPPLIER BE LIABLE FOR ANY INCIDENTAL OR CONSEQUENTIAL DAMAGES BASED ON ANY CLAIM OF INFRINGEMENT.

Supplier shall have no liability for any claim based on modifications of a product made by any person or entity other than Supplier, or based on use of a product in conjunction with any other item, unless expressly approved by Supplier. Supplier does not warrant goods against claims of infringement which are assembled, prepared, or manufactured to Buyer's specifications.

- (8) NON-WAIVER OF DEFAULT: Each shipment made under any order shall be treated as a separate transaction, but in the event of any default by Buyer, Supplier may decline to make further shipments without in any way affecting its rights under such order. If, despite any default by Buyer, Supplier elects to continue to make shipments, its action shall not constitute a waiver of that or any default by Buyer or in any way affect Supplier's legal remedies for any such default. At any time, Supplier's failure to exercise any right to remedy available to it shall not constitute a waiver of that right or remedy.

- (9) TERMINATION: If the products to be furnished under this order are to be used in the performance of a Government contract or subcontract, and the Government terminates such contract in whole or part, this order may be canceled to the extent it was to be used in the canceled portion of said Government contract and the liability of Buyer for termination allowances shall be determined by the then applicable regulations of the Government regarding termination of contracts. Supplier may cancel any unfilled orders unless Buyer shall, upon written notice, immediately pay for all goods delivered or shall pay in advance for all goods ordered but not delivered, or both, at Supplier's option.

- (10) LAW: The validity, performance and construction of these terms and conditions and any sale made hereunder shall be governed by the laws of the state of Texas.

- (11) ASSIGNS: This agreement shall not be assignable by either Supplier or Buyer. However, should either Supplier or Buyer be sold or transferred in its entirety and as an ongoing business, or should Supplier or Buyer sell or transfer in its entirety and as an ongoing concern, any division, department, or subsidiary responsible in whole or in part for the performance of this Agreement, this Agreement shall be binding upon and inure to the benefit of those successors and assigns of Supplier, Buyer, or such division, department, or subsidiary.

- (12) MODIFICATION OF STANDARD TERMS AND CONDITIONS: No attempted or suggested modification of or addition to any of the provisions upon the face or reverse of this form, whether contained or arising in correspondence and/or documents passing between Supplier and Buyer, in any course of dealing between Supplier or Buyer, or in any customary usage prevalent among businesses comparable to those of Supplier and/or Buyer, shall be binding upon Supplier unless made and agreed to in writing and signed by an officer of Supplier.

- (13) QUANTITIES: Any variation in quantities of electronic components, or other goods shipped over or under the quantities ordered (not to exceed 5%) shall constitute compliance with Buyer's order and the unit price will continue to apply.

Data Sheets

V-I Characteristics of Thyristor Devices	E0-2
Electrical Parameter Terminology	E0-3
Sensitive Triacs	E1
Triacs	E2
QUADRACs	E3
Alternistor Triacs	E4
Sensitive SCRs	E5
SCRs	E6
Rectifiers	E7
Diacs	E8
SIDAC	E9

V-I Characteristics of Thyristor Devices

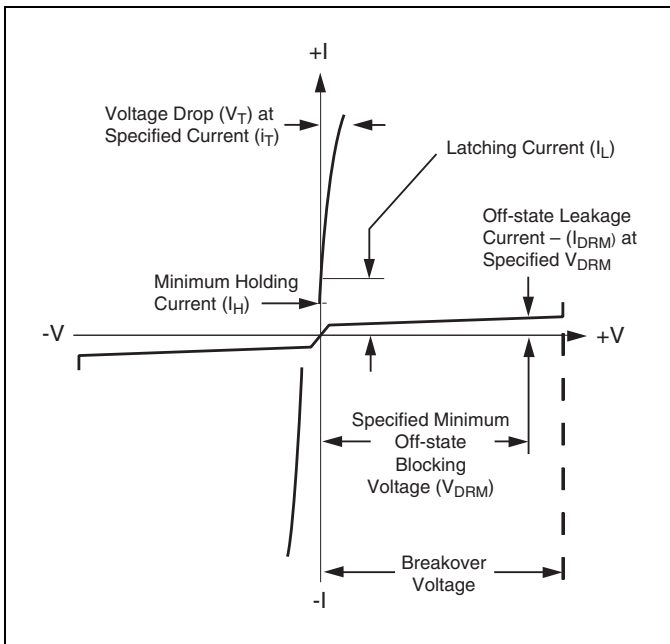

V-I Characteristics of Triac Device

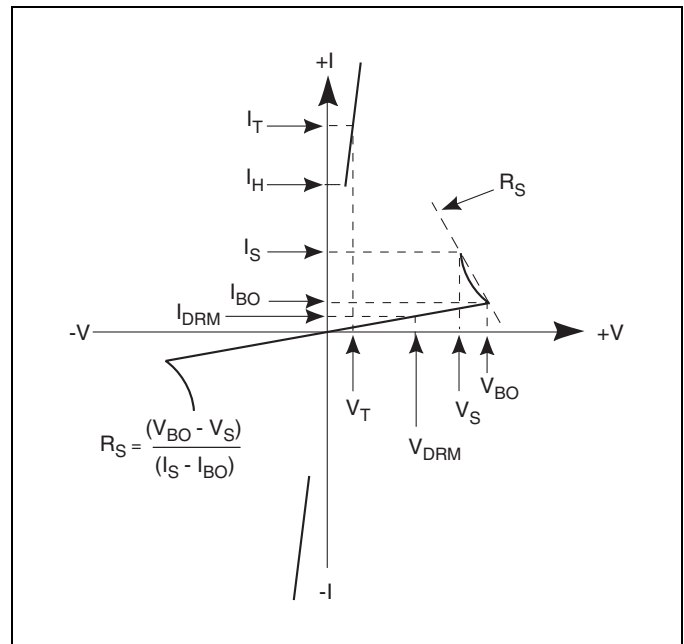

V-I Characteristics of Sidac Device with Negative Resistance

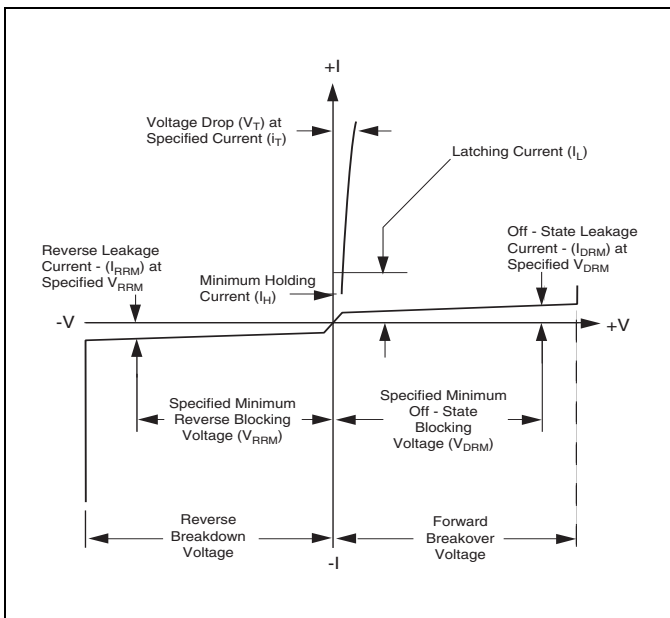

V-I Characteristics of SCR Device

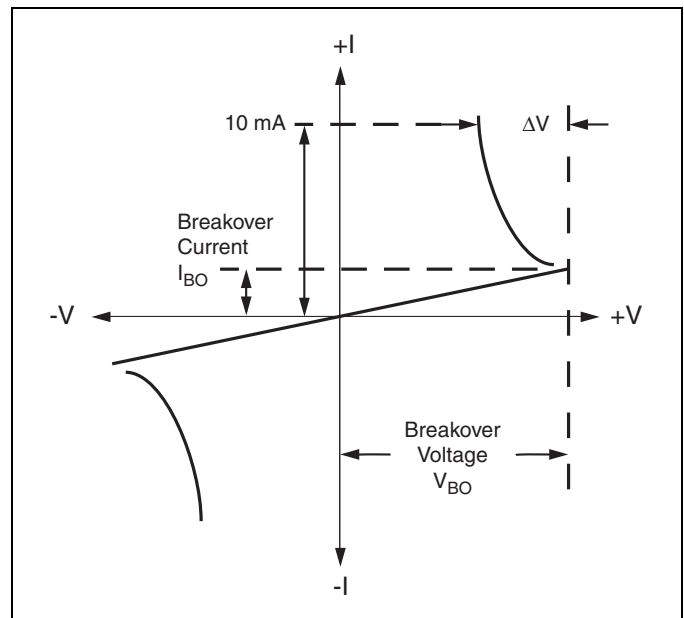

V-I Characteristics of Bilateral Trigger Diac

Thyristor

di/dt (Critical Rate-of-rise of On-state Current) – Maximum value of the rate-of-rise of on-state current which a thyristor can withstand without deleterious effect

dv/dt (Critical Rate-of-rise of Off-state Voltage or Static dv/dt) – Minimum value of the rate-of-rise of principal voltage which will cause switching from the off state to the on state

dv/dt(c) Critical Rate-of-rise of Commutation Voltage of a Triac (Commutating dv/dt) – Minimum value of the rate-of-rise of principal voltage which will cause switching from the off state to the on state immediately following on-state current conduction in the opposite quadrant

I²t (RMS Surge (Non-repetitive) On-state Fusing Current) – Measure of let-through energy in terms of current and time for fusing purposes

I_{BO} (Breakover Current) – Principal current at the breakover point

I_{DRM} (Repetitive Peak Off-state Current) – Maximum leakage current that may occur under the conditions of V_{DRM}

I_{GT} (Gate Trigger Current) – Minimum gate current required to switch a thyristor from the off state to the on state

I_H (Holding Current) – Minimum principal current required to maintain the thyristor in the on state

I_{PP} (Peak Pulse Current) – Peak pulse current at a short time duration and specified waveshape

I_{RRM} (Repetitive Peak Reverse Current) – Maximum leakage current that may occur under the conditions of V_{RRM}

I_S (Switching Current) – Current at V_S when a sidac switches from the clamping state to on state

I_{T(RMS)} (On-state Current) – Anode cathode principal current that may be allowed under stated conditions, usually the full-cycle RMS current

I_{TSM} (Surge (Non-repetitive) On-state Current) – Peak single cycle AC current pulse allowed

P_{G(AV)} (Average Gate Power Dissipation) – Value of gate power which may be dissipated between the gate and main terminal 1 (or cathode) average over a full cycle

P_{GM} (Peak Gate Power Dissipation) – Maximum power which may be dissipated between the gate and main terminal 1 (or cathode) for a specified time duration

R_{θJA} (Thermal Resistance, Junction-to-ambient) – Temperature difference between the thyristor junction and ambient divided by the power dissipation causing the temperature difference under conditions of thermal equilibrium

Note: Ambient is defined as the point where temperature does not change as a result of the dissipation.

R_{θJC} (Thermal Resistance, Junction-to-case) – Temperature difference between the thyristor junction and the thyristor case divided by the power dissipation causing the temperature difference under conditions of thermal equilibrium

t_{gt} (Gate-controlled Turn-on Time) – Time interval between the 10% rise of the gate pulse and the 90% rise of the principal current pulse during switching of a thyristor from the off state to the on state

t_q (Circuit-commutated Turn-off Time) – Time interval between the instant when the principal current has decreased to zero after external switching of the principal voltage circuit and the instant when the SCR is capable of supporting a specified principal voltage without turning on

V_{BO} (Breakover Voltage) – Principal voltage at the breakover point

V_{DRM} (Repetitive Peak Off-state Voltage) – Maximum allowable instantaneous value of repetitive off-state voltage that may be applied across a bidirectional thyristor (forward or reverse direction) or SCR (forward direction only)

V_{GT} (Gate Trigger Voltage) – Minimum gate voltage required to produce the gate trigger current

V_{RRM} (Repetitive Peak Reverse Voltage) – Maximum allowable instantaneous value of a repetitive reverse voltage that may be applied across an SCR without causing reverse current avalanche

V_S (Switching Voltage) – Voltage point after V_{BO} when a sidac switches from a clamping state to on state

V_T (On-state Voltage) – Principal voltage when the thyristor is in the on state

Diode Rectifiers

I_{F(AV)} (Average Forward Current) – Average forward conduction current

I_{FM} (Maximum (Peak) Reverse Current) – Maximum reverse leakage current that may occur at rated V_{RRM}

I_{F(RMS)} (RMS Forward Current) – RMS forward conduction current

I_{FSM} (Maximum (Peak) Forward (Non-repetitive) Surge Current) – Maximum (peak) forward single cycle AC surge current allowed for specified duration

V_{FM} (Maximum (Peak) Forward Voltage Drop) – Maximum (peak) forward voltage drop from the anode to cathode at stated conditions

V_R (Reverse Blocking Voltage) – Maximum allowable DC reverse blocking voltage that may be applied to the rectifier

V_{RRM} (Maximum (Peak) Repetitive Reverse Voltage) – Maximum peak allowable value of a repetitive reverse voltage that may be applied to the rectifier

Selected Packages*
U.L. RECOGNIZED
 File #E71639

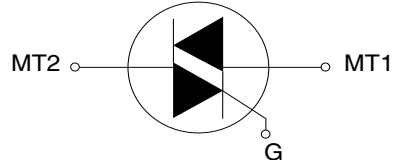
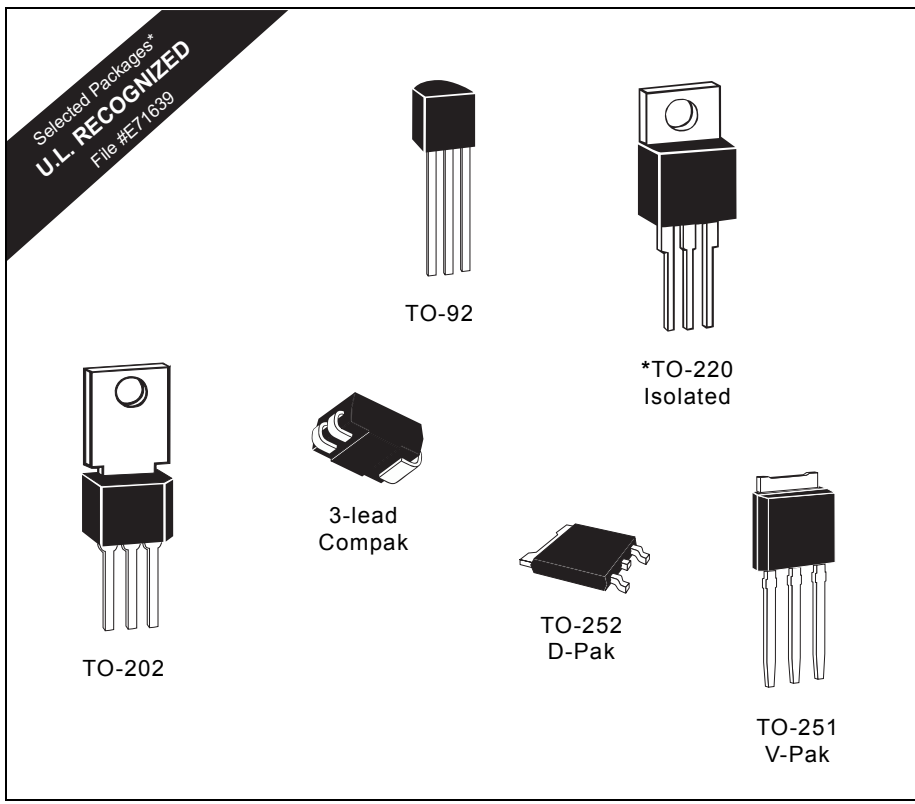

Sensitive Triacs

(0.8 A to 8 A)

General Description

Teccor's line of sensitive gate triacs includes devices with current capabilities through 8 A. Voltage ranges are available from 200 V to 600 V. This line features devices with guaranteed gate control in Quadrants II and IV as well as control in the commonly used Quadrants I and III. Four-quadrant control devices require sensitive gate triacs. They can be controlled by digital circuitry where positive-only or negative-only pulses must control AC current in both directions through the device. Note that triacs with low I_{GT} values in Quadrants II and IV will have lower dv/dt characteristics.

The sensitive gate triac is a bidirectional AC switch and is gate controlled for either polarity of main terminal voltage. It is used primarily for AC switching and phase control applications such as motor speed controls, temperature modulation controls, and lighting controls.

The epoxy TO-92 and TO-220 configurations feature Teccor's electrically-isolated construction where the case or mounting tab is internally isolated from the semiconductor chip and lead attachments. Non-isolated epoxy TO-202 packages are available as well as TO-251 and surface mount TO-252 (D-Pak). Tape-and-reel capability and tube packing also are available. See "Packing Options" section of this catalog.

All Teccor triacs have glass-passivated junctions. This glassing process prevents migration of contaminants and ensures long-term device reliability with parameter stability.

Variations of devices covered in this data sheet are available for custom design applications. Consult factory for more information.

Features

- Electrically-isolated packages
- Glass-passivated junctions ensure long device reliability and parameter stability
- Voltage capability — up to 600 V
- Surge capability — up to 80 A
- Four-quadrant gating guaranteed

Compak Sensitive Gate Triac

- Surface mount package — 0.8 A and 1 A series
- New small profile three-leaded Compak package
- Packaged in embossed carrier tape with 2,500 devices per reel
- Can replace SOT-223

I _{T(RMS)} (11)	Part No.						V _{DRM} (1)	I _{GT} (3) (6) (9)				I _{DRM} (1) (14)	
	Isolated			Non-isolated				mAmps	QI	QII	QIII	QIV	T _C = 25 °C
	TO-92	Compak	TO-220	TO-252 D-Pak	TO-202	TO-251 V-Pak	Volts						
MAX	See "Package Dimensions" section for variations. (12)						MIN	MAX				MAX	
0.8 A	L2X8E3	L2X3					200	3	3	3	3	0.01	0.1
	L4X8E3	L4X3					400	3	3	3	3	0.01	0.1
	L6X8E3	L6X3					600	3	3	3	3	0.01	0.1
	L2X8E5	L2X5					200	5	5	5	5	0.01	0.1
	L4X8E5	L4X5					400	5	5	5	5	0.01	0.1
	L6X8E5	L6X5					600	5	5	5	5	0.01	0.1
	L2X8E6						200	5	5	5	10	0.01	0.1
	L4X8E6						400	5	5	5	10	0.01	0.1
	L6X8E6						600	5	5	5	10	0.01	0.1
	L2X8E8						200	10	10	10	20	0.01	0.1
L4X8E8						400	10	10	10	20	0.01	0.1	
L6X8E8						600	10	10	10	20	0.01	0.1	
1 A	L201E3	L2N3					200	3	3	3	3	0.01	0.1
	L401E3	L4N3					400	3	3	3	3	0.01	0.1
	L601E3	L6N3					600	3	3	3	3	0.01	0.1
	L201E5	L2N5					200	5	5	5	5	0.01	0.1
	L401E5	L4N5					400	5	5	5	5	0.01	0.1
	L601E5	L6N5					600	5	5	5	5	0.01	0.1
	L201E6						200	5	5	5	10	0.01	0.1
	L401E6						400	5	5	5	10	0.01	0.1
	L601E6						600	5	5	5	10	0.01	0.1
	L201E8						200	10	10	10	20	0.01	0.1
L401E8						400	10	10	10	20	0.01	0.1	
L601E8						600	10	10	10	20	0.01	0.1	
4 A		L2004L3	L2004D3	L2004F31	L2004V3		200	3	3	3	3	0.01	0.2
		L4004L3	L4004D3	L4004F31	L4004V3		400	3	3	3	3	0.01	0.2
		L6004L3	L6004D3	L6004F31	L6004V3		600	3	3	3	3	0.01	0.2
		L2004L5	L2004D5	L2004F51	L2004V5		200	5	5	5	5	0.01	0.2
		L4004L5	L4004D5	L4004F51	L4004V5		400	5	5	5	5	0.01	0.2
		L6004L5	L6004D5	L6004F51	L6004V5		600	5	5	5	5	0.01	0.2
		L2004L6	L2004D6	L2004F61	L2004V6		200	5	5	5	10	0.01	0.2
		L4004L6	L4004D6	L4004F61	L4004V6		400	5	5	5	10	0.01	0.2
		L6004L6	L6004D6	L6004F61	L6004V6		600	5	5	5	10	0.01	0.2
		L2004L8	L2004D8	L2004F81	L2004V8		200	10	10	10	20	0.01	0.2
	L4004L8	L4004D8	L4004F81	L4004V8		400	10	10	10	20	0.01	0.2	
	L6004L8	L6004D8	L6004F81	L6004V8		600	10	10	10	20	0.01	0.2	

See "General Notes" on page E1 - 4 and "Electrical Specification Notes" on page E1 - 5.

V _{TM}	V _{GT}	I _H	I _{GTM}	P _{GM}	P _{G(AV)}	I _{TSM}	dv/dt(c)	dv/dt	t _{gt}	I ² t	di/dt
(1) (4)	(2) (5) (15)	(1) (7)	(13)	(13)		(8) (10)	(1) (10)	(1)	(9)		
Volts	Volts					Amps		Volts/μSec			
T _C = 25 °C	T _C = 25 °C	mAmps	Amps	Watts	Watts	60/50 Hz	Volts/μSec	T _C = 100 °C	μSec	Amps ² Sec	Amps/μSec
MAX	MAX	MAX					TYP	TYP	TYP		
1.6	2	5	1	10	0.2	10/8.3	0.5	20	2.8	0.41	20
1.6	2	5	1	10	0.2	10/8.3	0.5	15	2.8	0.41	20
1.6	2	5	1	10	0.2	10/8.3	0.5	10	2.8	0.41	20
1.6	2	10	1	10	0.2	10/8.3	1	20	3	0.41	20
1.6	2	10	1	10	0.2	10/8.3	1	15	3	0.41	20
1.6	2	10	1	10	0.2	10/8.3	1	10	3	0.41	20
1.6	2	10	1	10	0.2	10/8.3	1	30	3	0.41	20
1.6	2	10	1	10	0.2	10/8.3	1	25	3	0.41	20
1.6	2	10	1	10	0.2	10/8.3	1	20	3	0.41	20
1.6	2	15	1	10	0.2	10/8.3	2	35	3.2	0.41	20
1.6	2	15	1	10	0.2	10/8.3	2	30	3.2	0.41	20
1.6	2	15	1	10	0.2	10/8.3	2	25	3.2	0.41	20
1.6	2	5	1	10	0.2	20/16.7	0.5	20	2.8	1.6	20
1.6	2	5	1	10	0.2	20/16.7	0.5	10	2.8	1.6	20
1.6	2	10	1	10	0.2	20/16.7	1	20	3	1.6	20
1.6	2	10	1	10	0.2	20/16.7	1	20	3	1.6	20
1.6	2	10	1	10	0.2	20/16.7	1	10	3	1.6	20
1.6	2	10	1	10	0.2	20/16.7	1	30	3	1.6	20
1.6	2	10	1	10	0.2	20/16.7	1	30	3	1.6	20
1.6	2	10	1	10	0.2	20/16.7	1	20	3	1.6	20
1.6	2	15	1	10	0.2	20/16.7	1	35	3.2	1.6	20
1.6	2	15	1	10	0.2	20/16.7	1	35	3.2	1.6	20
1.6	2	15	1	10	0.2	20/16.7	1	25	3.2	1.6	20
1.6	2	5	1.2	15	0.3	40/33	0.5	25	2.8	6.6	50
1.6	2	5	1.2	15	0.3	40/33	0.5	25	2.8	6.6	50
1.6	2	5	1.2	15	0.3	40/33	0.5	15	2.8	6.6	50
1.6	2	10	1.2	15	0.3	40/33	1	25	3	6.6	50
1.6	2	10	1.2	15	0.3	40/33	1	25	3	6.6	50
1.6	2	10	1.2	15	0.3	40/33	1	15	3	6.6	50
1.6	2	10	1.2	15	0.3	40/33	1	30	3	6.6	50
1.6	2	10	1.2	15	0.3	40/33	1	30	3	6.6	50
1.6	2	10	1.2	15	0.3	40/33	1	20	3	6.6	50
1.6	2	15	1.2	15	0.3	40/33	2	35	3.2	6.6	50
1.6	2	15	1.2	15	0.3	40/33	2	35	3.2	6.6	50
1.6	2	15	1.2	15	0.3	40/33	2	25	3.2	6.6	50

See "General Notes" on page E1 - 4 and "Electrical Specification Notes" on page E1 - 5.

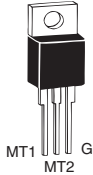
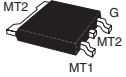
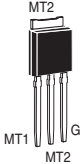
I _{T(RMS)} (11)	Part No.			V _{DRM} (1)	I _{GT} (3) (6)				I _{DRM} (1) (14)	
	Isolated	Non-isolated			mAmps				mAmps	
	 TO-220	 TO-252 D-Pak	 TO-251 V-Pak	Volts						
MAX	See "Package Dimensions" section for variations. (12)			MIN	MAX				MAX	
6 A	L2006L5	L2006D5	L2006V5	200	5	5	5	5	0.02	0.5
	L4006L5	L4006D5	L4006V5	400	5	5	5	5	0.02	0.5
	L6006L5	L6006D5	L6006V5	600	5	5	5	5	0.02	0.5
	L2006L6	L2006D6	L2006V6	200	5	5	5	10	0.02	0.5
	L4006L6	L4006D6	L4006V6	400	5	5	5	10	0.02	0.5
	L6006L6	L6006D6	L6006V6	600	5	5	5	10	0.02	0.5
	L2006L8	L2006D8	L2006V8	200	10	10	10	20	0.02	0.5
8 A	L4006L8	L4006D8	L4006V8	400	10	10	10	20	0.02	0.5
	L6006L8	L6006D8	L6006V8	600	10	10	10	20	0.02	0.5
	L2008L6	L2008D6	L2008V6	200	5	5	5	10	0.02	0.5
	L4008L6	L4008D6	L4008V6	400	5	5	5	10	0.02	0.5
	L6008L6	L6008D6	L6008V6	600	5	5	5	10	0.02	0.5
	L2008L8	L2008D8	L2008V8	200	10	10	10	20	0.02	0.5
	L4008L8	L4008D8	L4008V8	400	10	10	10	20	0.02	0.5
L6008L8	L6008D8	L6008V8	600	10	10	10	20	0.02	0.5	

Specified Test Conditions

- di/dt** — Maximum rate-of-change of on-state current; I_{GT} = 50 mA with 0.1 μs rise time
- dv/dt** — Critical rate-of-rise of off-state voltage at rated V_{DRM} gate open
- dv/dt(c)** — Critical rate-of-rise of commutation voltage at rated V_{DRM} and I_{T(RMS)} commutating di/dt = 0.54 rated I_{T(RMS)}/ms; gate unenergized
- I²t** — RMS surge (non-repetitive) on-state current for period of 8.3 ms for fusing
- I_{DRM}** — Peak off-state current, gate open; V_{DRM} = max rated value
- I_{GT}** — DC gate trigger current in specific operating quadrants; V_D = 12 V dc; R_L = 60 Ω
- I_{GTM}** — Peak gate trigger current
- I_H** — Holding current gate open; initial on-state current = 100 mA dc
- I_{T(RMS)}** — RMS on-state current conduction angle of 360°
- I_{TSM}** — Peak one-cycle surge
- P_{G(AV)}** — Average gate power dissipation
- P_{GM}** — Peak gate power dissipation; I_{GT} ≤ I_{GTM}
- t_{gt}** — Gate controlled turn-on time; I_{GT} = 50 mA with 0.1 μs rise time
- V_{DRM}** — Repetitive peak off-state/blocking voltage
- V_{GT}** — DC gate trigger voltage; V_D = 12 V dc; R_L = 60 Ω
- V_{TM}** — Peak on-state voltage at max rated RMS current

General Notes

- All measurements are made with 60 Hz resistive load and at an ambient temperature of +25 °C unless otherwise specified.
- Operating temperature range (T_J) is -65 °C to +110 °C for TO-92 devices and -40 °C to 110 °C for all other devices.
- Storage temperature range (T_S) is -65 °C to +150 °C for TO-92 devices, -40 °C to +150 °C for TO-202 devices, and -40 °C to +125 °C for TO-220 devices.
- Lead solder temperature is a maximum of 230 °C for 10 seconds maximum at a minimum of 1/16" (1.59 mm) from case.
- The case or lead temperature (T_C or T_L) is measured as shown on dimensional outline drawings. See "Package Dimensions" section of this catalog.

V_{TM}	V_{GT}	I_H	I_{GTM}	P_{GM}	$P_{G(AV)}$	I_{TSM}	$dv/dt(c)$	dv/dt	t_{gt}	I^2t	di/dt
(1) (4)	(2) (5) (15)	(1) (7)	(13)	(13)		(8) (10)	(1) (10)	(1)	(9)		
Volts $T_C = 25^\circ C$	Volts $T_C = 25^\circ C$	mAmps	Amps	Watts	Watts	Amps 60/50 Hz	Volts/ μ Sec	Volts/ μ Sec $T_C = 100^\circ C$	μ Sec	Amps ² Sec	Amps/ μ Sec
MAX	MAX	MAX					TYP	TYP	TYP		
1.6	2	10	1.6	18	0.4	60/50	1	40	3	15	70
1.6	2	10	1.6	18	0.4	60/50	1	30	3	15	70
1.6	2	10	1.6	18	0.4	60/50	1	20	3	15	70
1.6	2	10	1.6	18	0.4	60/50	2	40	3	15	70
1.6	2	10	1.6	18	0.4	60/50	2	30	3	15	70
1.6	2	10	1.6	18	0.4	60/50	2	20	3	15	70
1.6	2	20	1.6	18	0.4	60/50	2	45	3.2	15	70
1.6	2	20	1.6	18	0.4	60/50	2	40	3.2	15	70
1.6	2	20	1.6	18	0.4	60/50	2	30	3.2	15	70
1.6	2	10	1.6	18	0.4	80/65	2	40	3	26.5	70
1.6	2	10	1.6	18	0.4	80/65	2	30	3	26.5	70
1.6	2	10	1.6	18	0.4	80/65	2	20	3	26.5	70
1.6	2	20	1.6	18	0.4	80/65	2	45	3.2	26.5	70
1.6	2	20	1.6	18	0.4	80/65	2	40	3.2	26.5	70
1.6	2	20	1.6	18	0.4	80/65	2	30	3.2	26.5	70

Electrical Specification Notes

- (1) For either polarity of MT2 with reference to MT1 terminal
- (2) For either polarity of gate voltage V_{GT} with reference to MT1 terminal
- (3) See Gate Characteristics and Definition of Quadrants.
- (4) See Figure E1.4 for i_T versus v_T .
- (5) See Figure E1.6 for V_{GT} versus T_C .
- (6) See Figure E1.7 for I_{GT} versus T_C .
- (7) See Figure E1.5 for I_H versus T_C .
- (8) See Figure E1.9 for surge rating and specific duration.
- (9) See Figure E1.8 for t_{gt} versus I_{GT} .
- (10) See Figure E1.2 and Figure E1.3 for maximum allowable case temperature at maximum rated current.
- (11) See Figure E1.1, Figure E1.2, and Figure E1.3 for T_A or T_C versus $I_{T(RMS)}$.
- (12) See package outlines for lead form configurations. When ordering special lead forming, add type number as suffix to part number.
- (13) Pulse width $\leq 10 \mu s$
- (14) T_C or $T_L = T_J$ for test conditions in off state
- (15) Minimum non-trigger V_{GT} at $110^\circ C$ is 0.2 V.

Gate Characteristics

Teccor triacs may be turned on between gate and MT1 terminals in the following ways:

- In-phase signals (with standard AC line) using Quadrants I and III
- Application of unipolar pulses (gate always positive or negative), using Quadrants II and III with negative gate pulses and Quadrants I and IV with positive gate pulses

When maximum surge capability is required, pulses should be a minimum of one magnitude above I_{GT} rating with a steep rising waveform ($\leq 1 \mu s$ rise time).

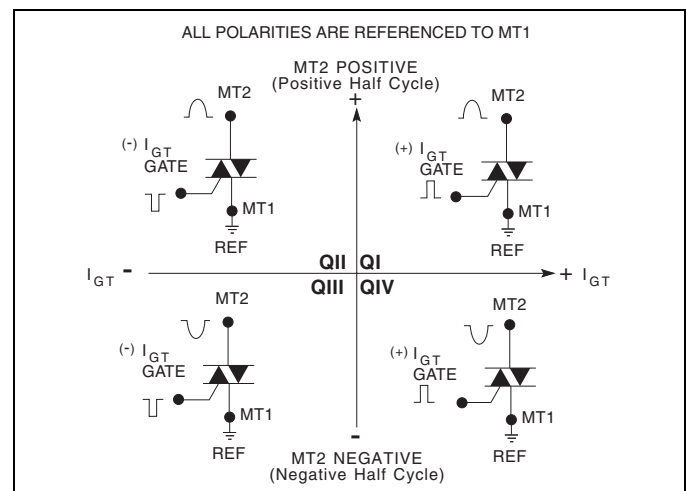







Definition of Quadrants

Electrical Isolation

Teccor's isolated triac packages withstand a minimum high potential test of 2500 V ac rms from leads to mounting tab over the device's operating temperature range. The following isolation table shows standard isolation ratings.

Electrical Isolation from Leads to Mounting Tab	
V AC RMS	TO-220 *
2500	Standard

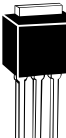
*UL Recognized File #E71639

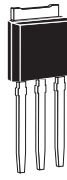
Thermal Resistance (Steady State) Junction to Mounting Tab and Junction to Ambient $R_{\theta JC}$ [$R_{\theta JA}$] °C/W (TYP)							
Package Code	E	C	F	L	F2	D	V
Type	 TO-92 Plastic	 Compak	 TO-202 Type 1	 TO-220 Isolated	 TO-202 Type 2	 TO-252 D-Pak	 TO-251 V-Pak
0.8 A	60 [135]	60 *					
1 A	50 [95]	40 *					
4 A			3.5 [45]	3.6 [50]	6.0 [70]	3.5	6.0 [70]
6 A				3.3		3.2	3.2
8 A				2.8		2.7	2.7

* Mounted on 1 cm² copper foil surface; two-ounce copper foil

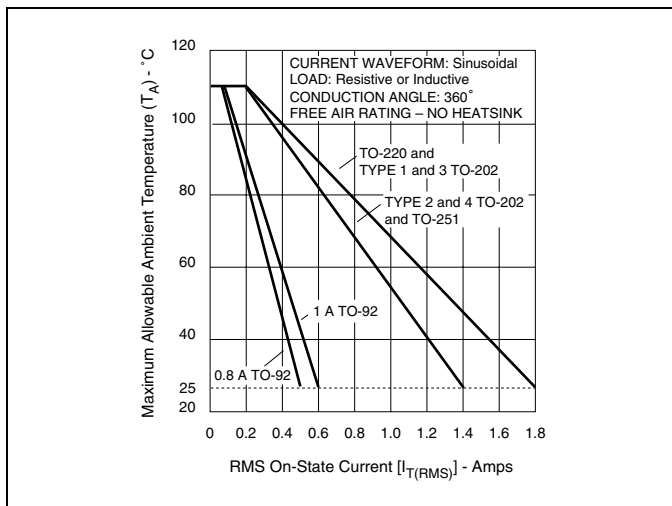

Figure E1.1 Maximum Allowable Ambient Temperature versus On-state Current

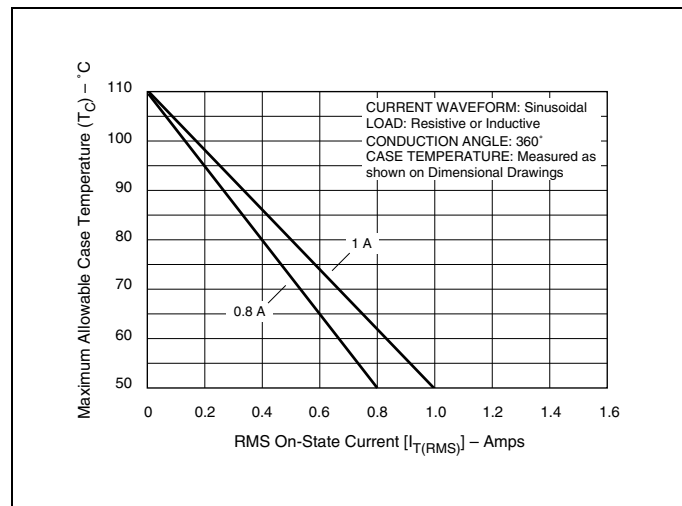
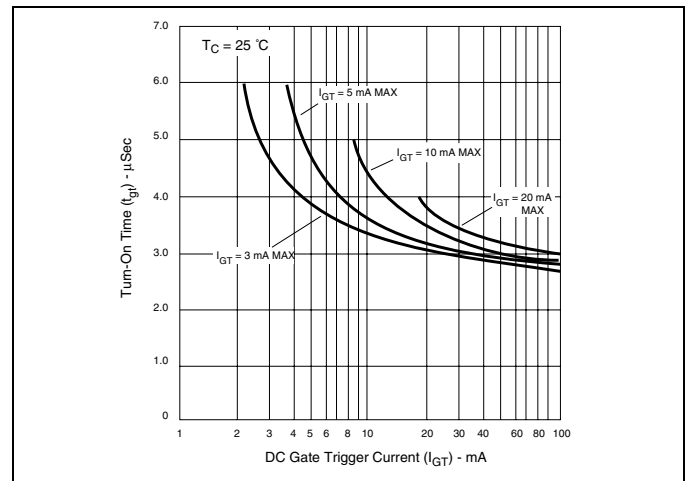
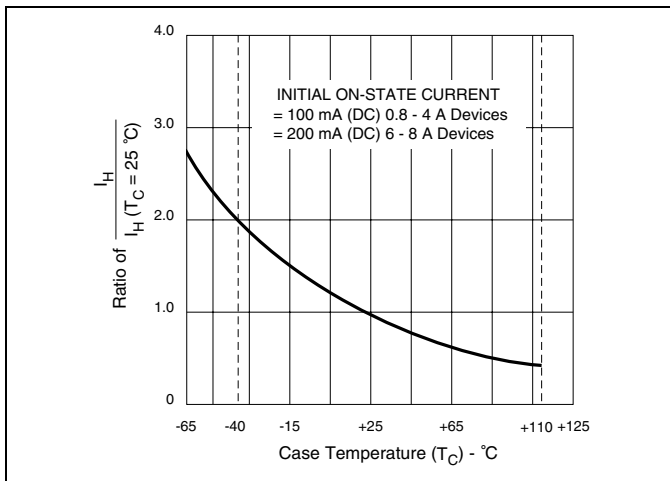
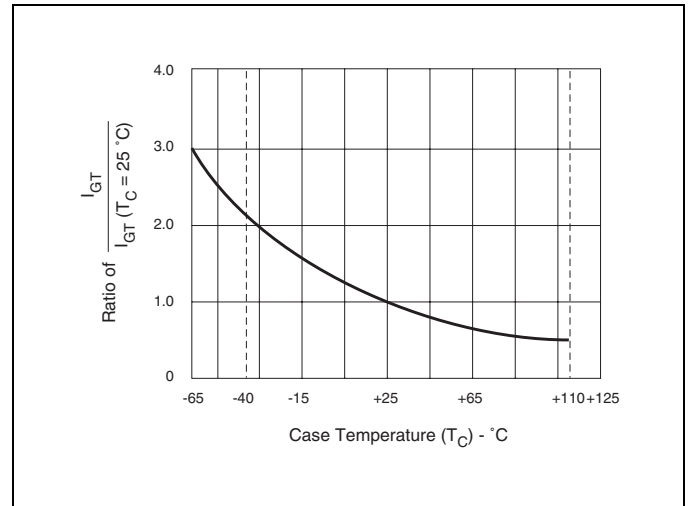
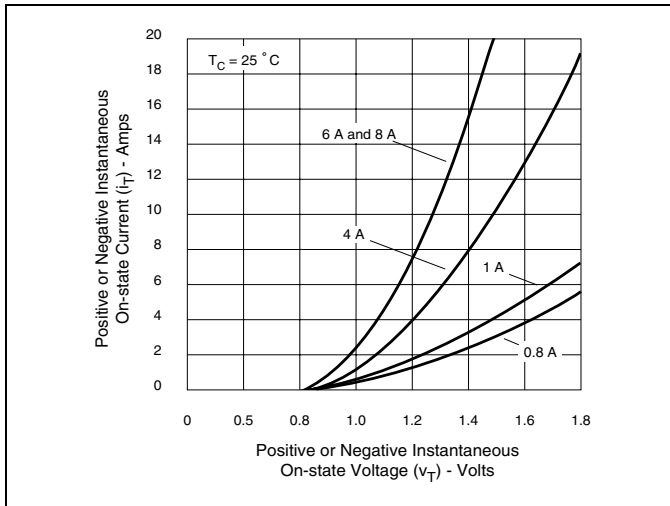
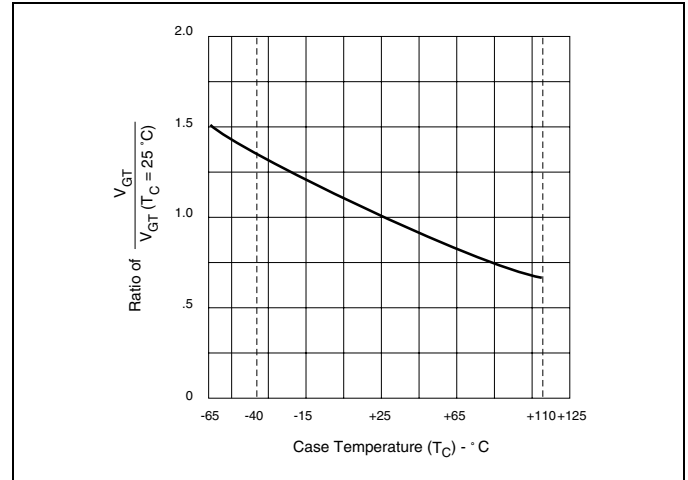
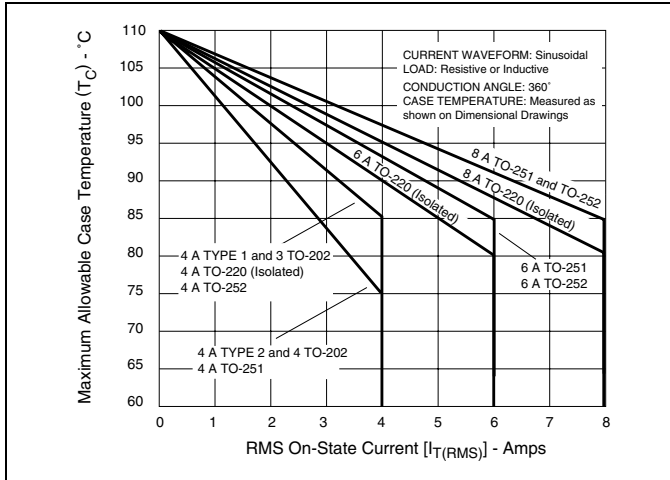

Figure E1.2 Maximum Allowable Case Temperature versus On-state Current (0.8 A and 1 A)



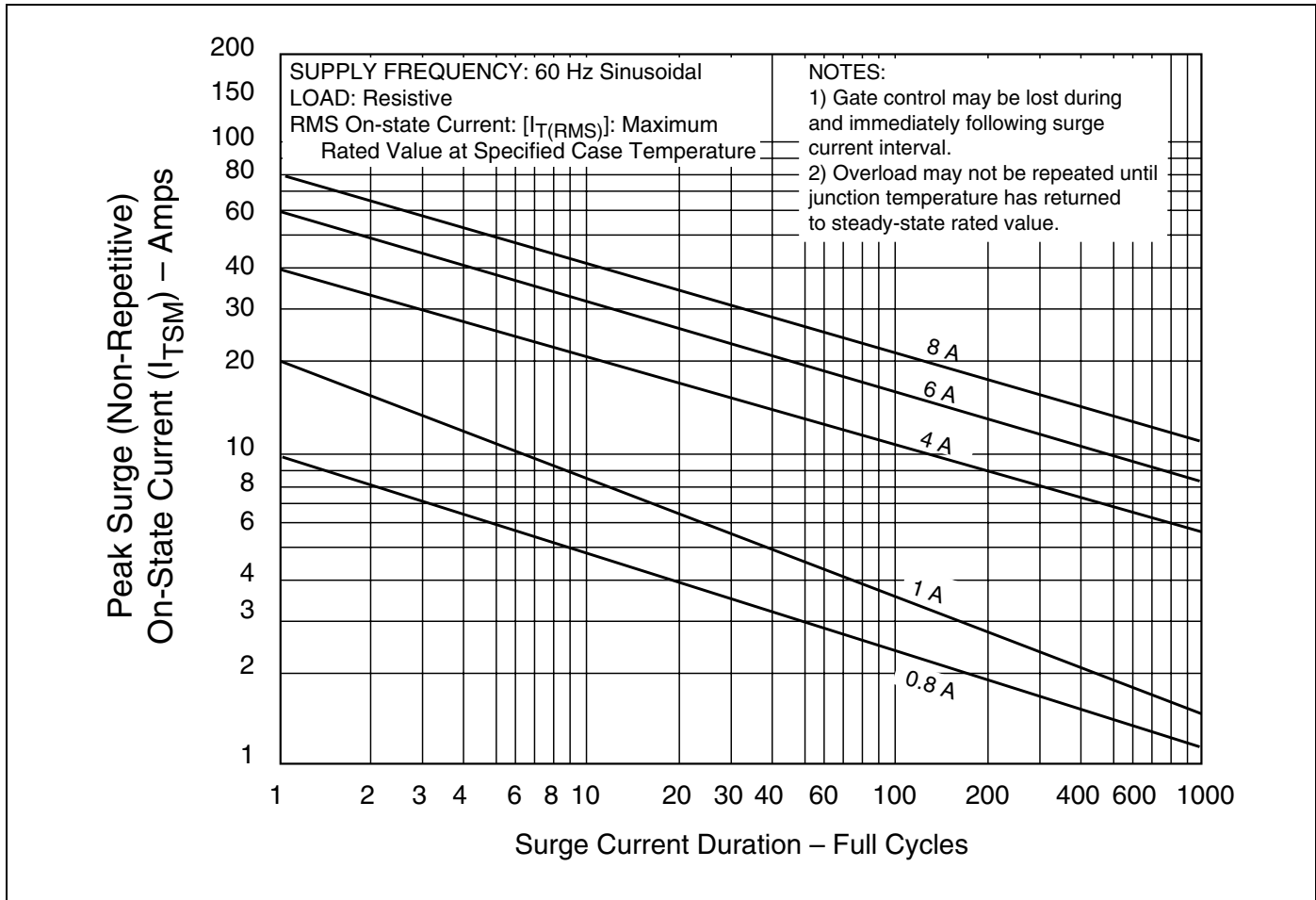

Figure E1.9 Peak Surge Current versus Surge Current Duration

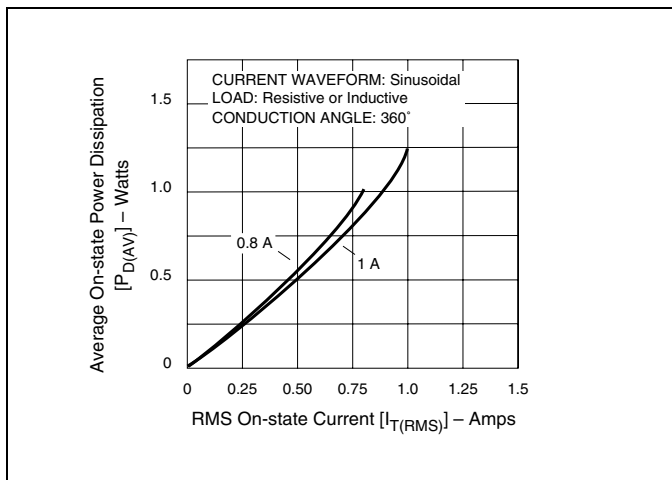

Figure E1.10 Power Dissipation (Typical) versus RMS On-state Current (0.8 A and 1 A)

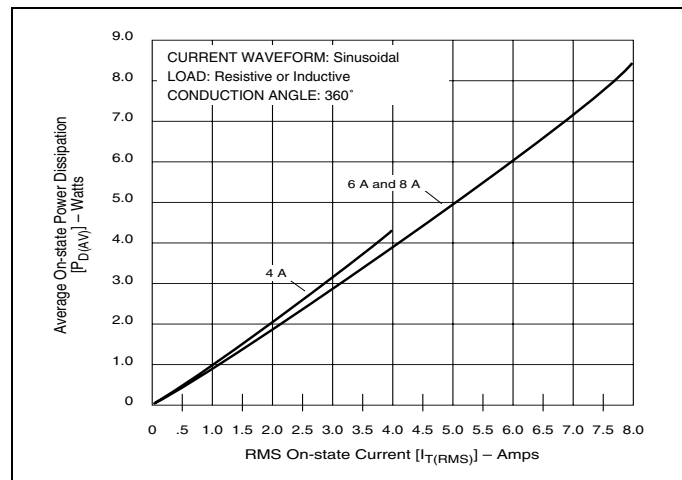
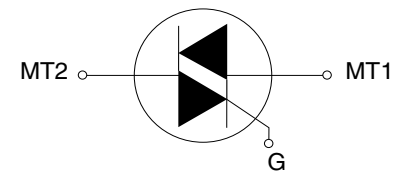
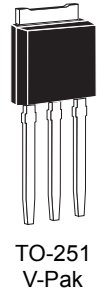
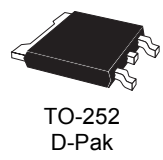
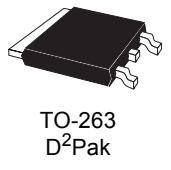
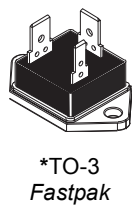
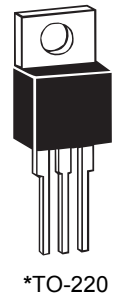
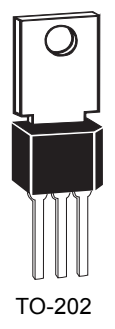
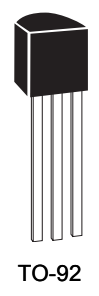

Figure E1.11 Power Dissipation (Typical) versus RMS On-state Current (4 A, 6 A, and 8 A)

Selected Packages
U.L. RECOGNIZED
 File #E71639



Triacs

(0.8 A to 35 A)

General Description

These gated triacs from Teccor Electronics are part of a broad line of bidirectional semiconductors. The devices range in current ratings from 0.8 A to 35 A and in voltages from 200 V to 1000 V.

The triac may be gate triggered from a blocking to conduction state for either polarity of applied voltage and is designed for AC switching and phase control applications such as speed and temperature modulation controls, lighting controls, and static switching relays. The triggering signal is normally applied between the gate and MT1.

Isolated packages are offered with internal construction, having the case or mounting tab electrically isolated from the semiconductor chip. This feature facilitates the use of low-cost assembly and convenient packaging techniques. Tape-and-reel capability is available. See "Packing Options" section of this catalog.

All Teccor triacs have glass-passivated junctions to ensure long-term device reliability and parameter stability. Teccor's glass-passivated junctions offer a rugged, reliable barrier against junction contamination.



Variations of devices covered in this data sheet are available for custom design applications. Consult factory for more information.

Features

- Electrically-isolated packages
- Glass-passivated junctions
- Voltage capability — up to 1000 V
- Surge capability — up to 200 A

Compak Package

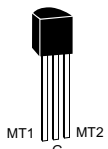
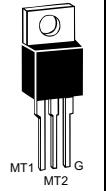
- Surface mount package — 0.8 A and 1 A series
- New small profile three-leaded Compak package
- Packaged in embossed carrier tape with 2,500 devices per reel
- Can replace SOT-223

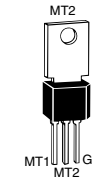
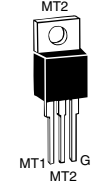
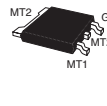
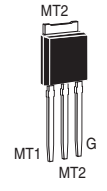
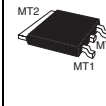
I _{T(RMS)} (4)	Part Number								V _{DRM} (1)	I _{GT} (3) (7) (15)					
	Isolated			Non-isolated						Volts	mAmps				
										QI	QII	QIII	QIV	QIV	
MAX	See "Package Dimensions" section for variations. (11)								MIN	MAX					TYP
0.8 A	Q2X8E3		Q2X3						200	10	10	10		25	
	Q4X8E3		Q4X3						400	10	10	10		25	
	Q6X8E3		Q6X3						600	10	10	10		25	
	Q2X8E4		Q2X4						200	25	25	25		50	
	Q4X8E4		Q4X4						400	25	25	25		50	
1 A	Q6X8E4		Q6X4						600	25	25	25		50	
	Q201E3		Q2N3						200	10	10	10		25	
	Q401E3		Q4N3						400	10	10	10		25	
	Q601E3		Q6N3						600	10	10	10		25	
	Q201E4		Q2N4						200	25	25	25		50	
4 A	Q401E4		Q4N4						400	25	25	25		50	
	Q601E4		Q6N4						600	25	25	25		50	
		Q2004L3		Q2004F31		Q2004D3	Q2004V3		200	10	10	10		25	
		Q4004L3		Q4004F31		Q4004D3	Q4004V3		400	10	10	10		25	
		Q6004L3		Q6004F31		Q6004D3	Q6004V3		600	10	10	10		25	
		Q2004L4		Q2004F41		Q2004D4	Q2004V4		200	25	25	25		50	
		Q4004L4		Q4004F41		Q4004D4	Q4004V4		400	25	25	25		50	
		Q6004L4		Q6004F41		Q6004D4	Q6004V4		600	25	25	25		50	
	Q8004L4				Q8004D4	Q8004V4		800	25	25	25		50		
6 A		QK004L4			QK004D4	QK004V4		1000	25	25	25		50		
		Q2006L4		Q2006F41	Q2006R4		Q2006N4	200	25	25	25		50		
		Q4006L4		Q4006F41	Q4006R4		Q4006N4	400	25	25	25		50		
		Q6006L5		Q6006F51	Q6006R5		Q6006N5	600	50	50	50		75		
		Q8006L5			Q8006R5		Q8006N5	800	50	50	50		75		
8 A		QK006L5			QK006R5		QK006N5	1000	50	50	50		75		
		Q2008L4		Q2008F41	Q2008R4		Q2008N4	200	25	25	25		50		
		Q4008L4		Q4008F41	Q4008R4		Q4008N4	400	25	25	25		50		
		Q6008L5		Q6008F51	Q6008R5		Q6008N5	600	50	50	50		75		
		Q8008L5			Q8008R5		Q8008N5	800	50	50	50		75		
	QK008L5			QK008R5		QK008N5	1000	50	50	50		75			

See "General Notes" on page E2 - 4 and "Electrical Specification Notes" on page E2 - 5.

I_{DRM}			V_{TM}	V_{GT}	I_H	I_{GTM}	P_{GM}	$P_{G(AV)}$	I_{TSM}	$dv/dt(c)$	dv/dt		t_{gt}	I^2t	di/dt
(1) (16)			(1) (5)	(2) (6) (15) (18) (19)	(1) (8) (12)	(14)	(14)		(9) (13)	(1) (4) (13)	(1)		(10)		
mAmps			Volts	Volts					Amps		Volts/ μ Sec				
$T_C = 25^\circ C$	$T_C = 100^\circ C$	$T_C = 125^\circ C$	$T_C = 25^\circ C$	$T_C = 25^\circ C$	mAmps	Amps	Watts	Watts	60/50 Hz	Volts/ μ Sec	$T_C = 100^\circ C$	$T_C = 125^\circ C$	μ Sec	Amp ² Sec	Amps/ μ Sec
MAX			MAX	MAX	MAX					TYP	MIN		TYP		
0.02	0.5	1	1.6	2	15	1	10	0.2	10/8.3	1	40	30	2.5	0.41	20
0.02	0.5	1	1.6	2	15	1	10	0.2	10/8.3	1	35	25	2.5	0.41	20
0.02	0.5	1	1.6	2	15	1	10	0.2	10/8.3	1	25	15	2.5	0.41	20
0.02	0.5	1	1.6	2.5	25	1	10	0.2	10/8.3	1	50	40	3	0.41	20
0.02	0.5	1	1.6	2.5	25	1	10	0.2	10/8.3	1	45	35	3	0.41	20
0.02	0.5	1	1.6	2.5	25	1	10	0.2	10/8.3	1	35	25	3	0.41	20
0.02	0.5	1	1.6	2	15	1	10	0.2	20/16.7	1	40	30	2.5	1.6	30
0.02	0.5	1	1.6	2	15	1	10	0.2	20/16.7	1	40	30	2.5	1.6	30
0.02	0.5	1	1.6	2	15	1	10	0.2	20/16.7	1	30	20	2.5	1.6	30
0.02	0.5	1	1.6	2.5	25	1	10	0.2	20/16.7	1	50	40	3	1.6	30
0.02	0.5	1	1.6	2.5	25	1	10	0.2	20/16.7	1	50	40	3	1.6	30
0.02	0.5	1	1.6	2.5	25	1	10	0.2	20/16.7	1	40	30	3	1.6	30
0.05	0.5	2	1.6	2	20	1.2	15	0.3	55/46	2	50	40	2.5	12.5	50
0.05	0.5	2	1.6	2	20	1.2	15	0.3	55/46	2	50	40	2.5	12.5	50
0.05	0.5	2	1.6	2	20	1.2	15	0.3	55/46	2	40	30	2.5	12.5	50
0.05	0.5	2	1.6	2.5	30	1.2	15	0.3	55/46	2	100	75	3	12.5	50
0.05	0.5	2	1.6	2.5	30	1.2	15	0.3	55/46	2	100	75	3	12.5	50
0.05	0.5	2	1.6	2.5	30	1.2	15	0.3	55/46	2	75	50	3	12.5	50
0.05	0.5	2	1.6	2.5	30	1.2	15	0.3	55/46	2	60	40	3	12.5	50
0.05	3		1.6	2.5	30	1.2	15	0.3	55/46	2	50		3	12.5	50
0.05	0.5	2	1.6	2.5	50	1.6	18	0.5	80/65	4	200	120	3	26.5	70
0.05	0.5	2	1.6	2.5	50	1.6	18	0.5	80/65	4	200	120	3	26.5	70
0.05	0.5	2	1.6	2.5	50	1.6	18	0.5	80/65	4	150	100	3	26.5	70
0.05	0.5	2	1.6	2.5	50	1.6	18	0.5	80/65	4	125	85	3	26.5	70
0.05	3		1.6	2.5	50	1.6	18	0.5	80/65	4	100		3	26.5	70
0.05	0.5	2	1.6	2.5	50	1.8	20	0.5	100/83	4	250	150	3	41	70
0.05	0.5	2	1.6	2.5	50	1.8	20	0.5	100/83	4	250	150	3	41	70
0.05	0.5	2	1.6	2.5	50	1.8	20	0.5	100/83	4	220	125	3	41	70
0.05	0.5	2	1.6	2.5	50	1.8	20	0.5	100/83	4	150	100	3	41	70
0.05	3		1.6	2.5	50	1.8	20	0.5	100/83	4	100		3	41	70

See "General Notes" on page E2 - 4 and "Electrical Specification Notes" on page E2 - 5.

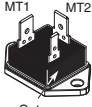
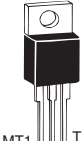
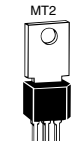
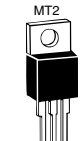
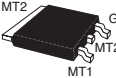
I _{T(RMS)} (4) (16)	Part Number					V _{DRM} (1)	I _{GT} (3) (7) (15)					I _{DRM} (1) (16)			
	Isolated		Non-isolated				mAmps					mAmps			
						Volts	QI	QII	QIII	QIV	QIV	T _C = 25 °C	T _C = 100 °C	T _C = 125 °C	
MAX	See "Package Dimensions" section for variations. (11)					MIN	MAX					TYP	MAX		
10 A		Q2010L4		Q2010R4	Q2010N4	200	25	25	25	50		0.05	1		
		Q4010L4		Q4010R4	Q4010N4	400	25	25	25	50		0.05	1		
		Q6010L4		Q6010R4	Q6010N4	600	25	25	25	50		0.05	1		
		Q8010L4		Q8010R4	Q8010N4	800	25	25	25	50		0.1	1		
		QK010L4		QK010R4	QK010N4	1000	25	25	25	50		0.1	3		
		Q2010L5	Q2010F51	Q2010R5	Q2010N5	200	50	50	50		75	0.05	0.5	2	
		Q4010L5	Q4010F51	Q4010R5	Q4010N5	400	50	50	50		75	0.05	0.5	2	
		Q6010L5	Q6010F51	Q6010R5	Q6010N5	600	50	50	50		75	0.05	0.5	2	
15 A				Q8010R5	Q8010N5	800	50	50	50		75	0.1	0.5	2	
				QK010R5	QK010N5	1000	50	50	50		75	0.1	3		
		Q2015L5		Q2015R5	Q2015N5	200	50	50	50			0.05	0.5	2	
		Q4015L5		Q4015R5	Q4015N5	400	50	50	50			0.05	0.5	2	
		Q6015L5		Q6015R5	Q6015N5	600	50	50	50			0.05	0.5	2	
25 A				Q8015R5	Q8015N5	800	50	50	50			0.1	1	3	
				QK015R5	QK015N5	1000	50	50	50			0.1	3		
				Q2025R5	Q2025N5	200	50	50	50			0.1	1	3	
				Q4025R5	Q4025N5	400	50	50	50			0.1	1	3	
				Q6025R5	Q6025N5	600	50	50	50			0.1	1	3	
				Q8025R5	Q8025N5	800	50	50	50			0.1	1	3	
				QK025R5	QK025N5	1000	50	50	50			0.1	3		
35 A		Q6025P5				600	50	50	50		120	0.1		5	
		Q8025P5				800	50	50	50		120	0.1		5	
		Q6035P5				600	50	50	50		120	0.1		5	
		Q8035P5				800	50	50	50		120	0.1		5	

Specific Test Conditions

- di/dt** — Maximum rate-of-change of on-state current; I_{GT} = 200 mA with ≤0.1 μs rise time
- dv/dt** — Critical rate-of-rise of off-state voltage at rated V_{DRM} gate open
- dv/dt(c)** — Critical rate-of-rise of commutation voltage at rated V_{DRM} and I_{T(RMS)} commutating di/dt = 0.54 rated I_{T(RMS)}/ms; gate unenergized
- I²t** — RMS surge (non-repetitive) on-state current for period of 8.3 ms for fusing
- I_{DRM}** — Peak off-state current, gate open; V_{DRM} = maximum rated value
- I_{GT}** — DC gate trigger current in specific operating quadrants; V_D = 12 V dc
- I_{GTM}** — Peak gate trigger current
- I_H** — Holding current (DC); gate open
- I_{T(RMS)}** — RMS on-state current conduction angle of 360°
- I_{TSM}** — Peak one-cycle surge
- P_{G(AV)}** — Average gate power dissipation
- P_{GM}** — Peak gate power dissipation; I_{GT} ≤ I_{GTM}
- t_{gt}** — Gate controlled turn-on time; I_{GT} = 200 mA with 0.1 μs rise time

- V_{DRM}** — Repetitive peak blocking voltage
- V_{GT}** — DC gate trigger voltage; V_D = 12 V dc; R_L = 60 Ω
- V_{TM}** — Peak on-state voltage at maximum rated RMS current

General Notes

- All measurements are made at 60 Hz with a resistive load at an ambient temperature of +25 °C unless specified otherwise.
- Operating temperature range (T_J) is -65 °C to +125 °C for TO-92, -25 °C to +125 °C for Fastpak, and -40 °C to +125 °C for all other devices.
- Storage temperature range (T_S) is -65 °C to +150 °C for TO-92, -40 °C to +150 °C for TO-202, and -40 °C to +125 °C for all other devices.
- Lead solder temperature is a maximum of 230 °C for 10 seconds, maximum; ≥1/16" (1.59 mm) from case.
- The case temperature (T_C) is measured as shown on the dimensional outline drawings. See "Package Dimensions" section of this catalog.

V_{TM}	V_{GT}	I_H	I_{GTM}	P_{GM}	$P_{G(AV)}$	I_{TSM}	$dv/dt(c)$	dv/dt		t_{gt}	I^2t	di/dt
(1) (5)	(2) (6) (15) (18) (19)	(1) (8) (12)	(14)	(14)		(9) (13)	(1) (4) (13)	(1)		(10) (17)		
Volts	Volts					Amps		Volts/ μ Sec				
$T_C = 25^\circ C$	$T_C = 25^\circ C$	mAmps	Amps	Watts	Watts	60/50 Hz	Volts/ μ Sec	$T_C = 100^\circ C$	$T_C = 125^\circ C$	μ Sec	Amps ² Sec	Amps/ μ Sec
MAX	MAX	MAX					TYP	MIN		TYP		
1.6	2.5	35	1.8	20	0.5	120/100	2	150		3	60	70
1.6	2.5	35	1.8	20	0.5	120/100	2	150		3	60	70
1.6	2.5	35	1.8	20	0.5	120/100	2	100		3	60	70
1.6	2.5	35	1.8	20	0.5	120/100	2	75		3	60	70
1.6	2.5	35	1.8	20	0.5	120/100	2	50		3	60	70
1.6	2.5	50	1.8	20	0.5	120/100	4	350	225	3	60	70
1.6	2.5	50	1.8	20	0.5	120/100	4	350	225	3	60	70
1.6	2.5	50	1.8	20	0.5	120/100	4	300	200	3	60	70
1.6	2.5	50	1.8	20	0.5	120/100	4	250	175	3	60	70
1.6	2.5	50	1.8	20	0.5	120/100	4	150		3	60	70
1.6	2.5	70	2	20	0.5	200/167	4	400	275	4	166	100
1.6	2.5	70	2	20	0.5	200/167	4	400	275	4	166	100
1.6	2.5	70	2	20	0.5	200/167	4	350	225	4	166	100
1.6	2.5	70	2	20	0.5	200/167	4	300	200	4	166	100
1.6	2.5	70	2	20	0.5	200/167	4	200		4	166	100
1.8	2.5	100	2	20	0.5	200/167	5	400	275	4	166	100
1.8	2.5	100	2	20	0.5	200/167	5	400	275	4	166	100
1.8	2.5	100	2	20	0.5	200/167	5	350	225	4	166	100
1.8	2.5	100	2	20	0.5	200/167	5	300	200	4	166	100
1.8	2.5	100	2	20	0.5	200/167	5	200		4	166	100
1.4	2.75	50	2	20	0.5	250/220	5	550	475	3	260	100
1.4	2.75	50	2	20	0.5	250/220	5	450	400	3	260	100
1.5	2.75	50	2	20	0.5	350/300	5	550	475	3	508	100
1.5	2.75	50	2	20	0.5	350/300	5	450	400	3	508	100

Electrical Specification Notes

- (1) For either polarity of MT2 with reference to MT1 terminal
- (2) For either polarity of gate voltage (V_{GT}) with reference to MT1 terminal
- (3) See Gate Characteristics and Definition of Quadrants.
- (4) See Figure E2.1 through Figure E2.7 for current rating at specific operating temperature.
- (5) See Figure E2.8 through Figure E2.10 for i_T versus v_T .
- (6) See Figure E2.12 for V_{GT} versus T_C .
- (7) See Figure E2.11 for I_{GT} versus T_C .
- (8) See Figure E2.14 for I_H versus T_C .
- (9) See Figure E2.13 for surge rating with specific durations.
- (10) See Figure E2.15 for t_{gt} versus I_{GT} .
- (11) See package outlines for lead form configurations. When ordering special lead forming, add type number as suffix to part number.
- (12) Initial on-state current = 200 mA dc for 0.8 A to 10 A devices, 400 mA dc for 15 A to 35 A devices
- (13) See Figure E2.1 through Figure E2.6 for maximum allowable case temperature at maximum rated current.
- (14) Pulse width $\leq 10 \mu s$; $I_{GT} \leq I_{GTM}$

- (15) $R_L = 60 \Omega$ for 0.8 A to 10 A triacs; $R_L = 30 \Omega$ for 15 A to 35 A triacs
- (16) $T_C = T_J$ for test conditions in off state
- (17) $I_{GT} = 300$ mA for 25 A and 35 A devices
- (18) Quadrants I, II, III only
- (19) Minimum non-trigger V_{GT} at 125 °C is 0.2 V for all except 50 mA MAX QIV devices which are 0.2 V at 110 °C.

Gate Characteristics

Teccor triacs may be turned on between gate and MT1 terminals in the following ways:

- In-phase signals (with standard AC line) using Quadrants I and III
- Application of unipolar pulses (gate always positive or negative), using Quadrants II and III with negative gate pulses and Quadrants I and IV with positive gate pulses

However, due to higher gate requirements for Quadrant IV, it is recommended that only negative pulses be applied. If positive pulses are required, see "Sensitive Triacs" section of this catalog or contact the factory. Also, see Figure AN1002.8, "Amplified Gate" Thyristor Circuit.

In all cases, if maximum surge capability is required, pulses should be a minimum of one magnitude above I_{GT} rating with a steep rising waveform ($\leq 1 \mu s$ rise time).

Electrical Isolation

Teccor's isolated triac packages will withstand a minimum high potential test of 2500 V ac rms from leads to mounting tab or base, over the operating temperature range of the device. The following isolation table shows standard and optional isolation ratings.

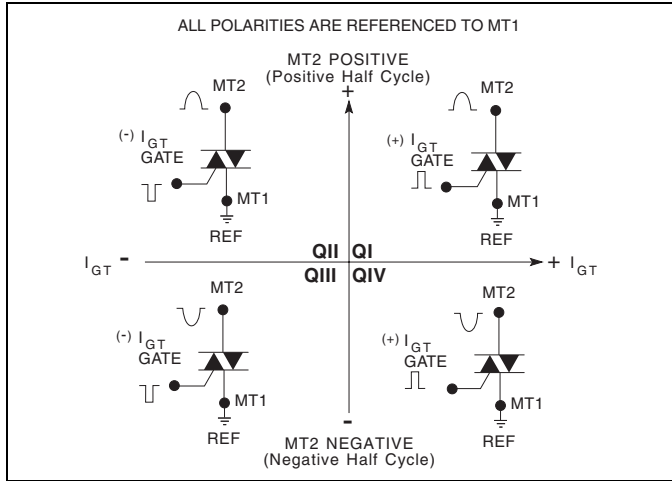

Definition of Quadrants

Electrical Isolation from Leads to Mounting Tab *		
V AC RMS	TO-220 Isolated	Fastpak Isolated
2500	Standard	Standard
4000	Optional **	N/A

* UL Recognized File E71639

** For 4000 V isolation, use V suffix in part number.

Thermal Resistance (Steady State) $R_{\theta JC}$ [$R_{\theta JA}$] (TYP.) °C/W										
Package Code	P	E	C	F	F2	L	R	D	V	N
Type										
	TO-3 Fastpak	TO-92	Compak	TO-202 Type 1	TO-202 Type 2	TO-220 Isolated	TO-220 Non-isolated	TO-252 D-Pak	TO-251 V-Pak	TO-263 D²Pak
0.8 A		60 [135]	60 *							
1 A		50 [95]	40 *							
4 A				3.5 [45]	6 [70]	3.6 [50]		3.5	6.0 [70]	
6 A				3.8		3.3	1.8 [45]			1.8
8 A				3.3		2.8	1.5			1.5
10 A				3.5		2.6	1.3			1.3
15 A						2.1	1.1			1.1
25 A	1.6						0.89			0.89
35 A	1.5									

* Mounted on 1 cm² copper foil surface; two-ounce copper foil

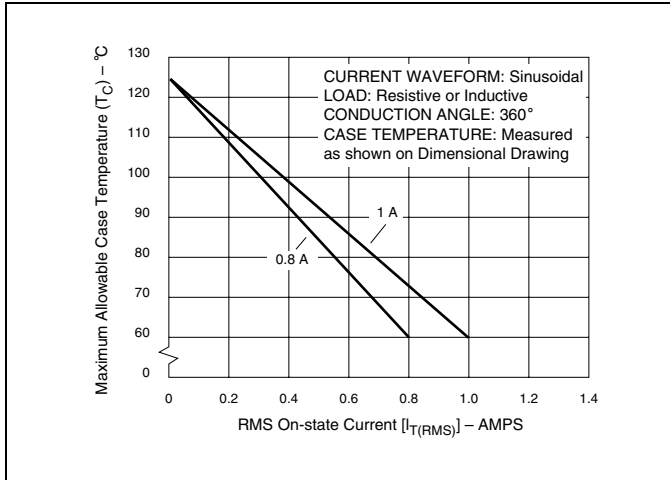

Figure E2.1 Maximum Allowable Case Temperature versus On-state Current (0.8 A and 1 A)

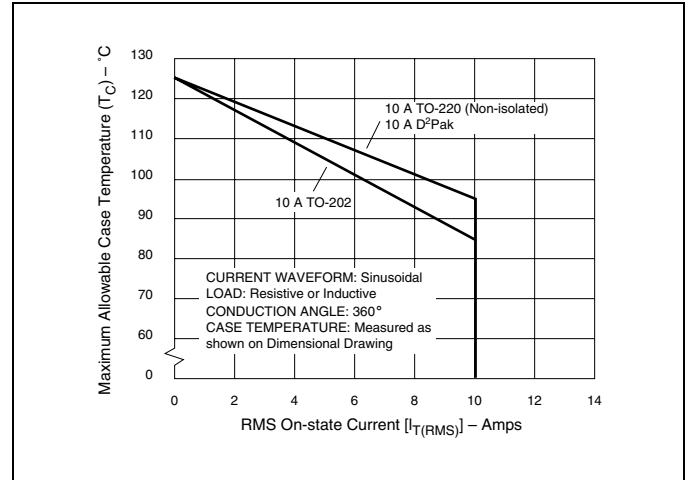

Figure E2.4 Maximum Allowable Case Temperature versus On-state Current (10 A)

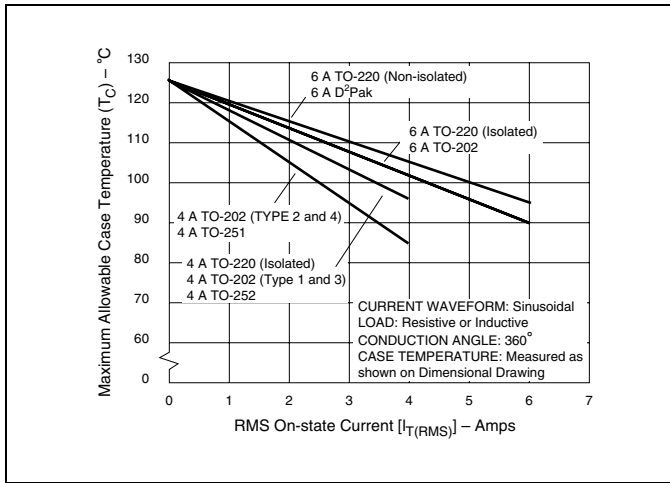

Figure E2.2 Maximum Allowable Case Temperature versus On-state Current (4 A and 6 A)

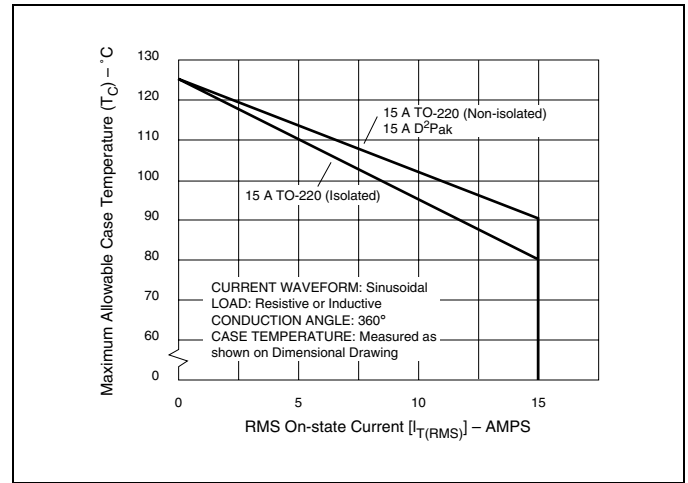

Figure E2.5 Maximum Allowable Case Temperature versus On-state Current (15 A)

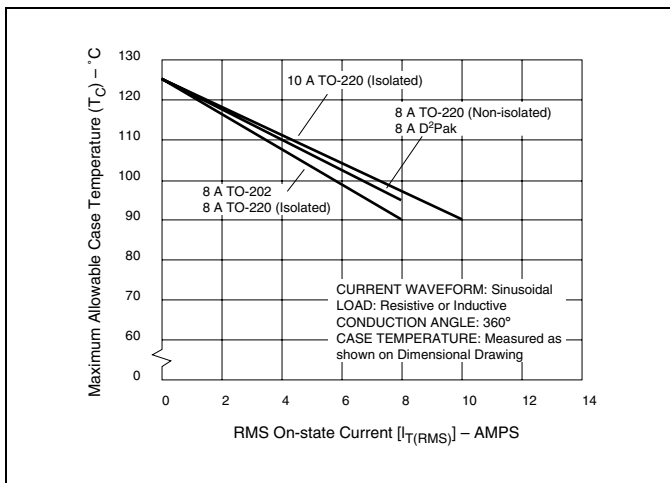

Figure E2.3 Maximum Allowable Case Temperature versus On-state Current (8 A and 10 A)

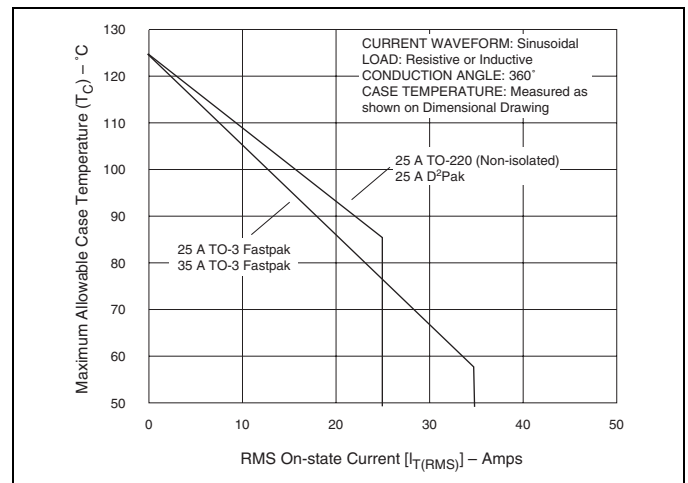

Figure E2.6 Maximum Allowable Case Temperature versus On-state Current (25 A and 35 A)

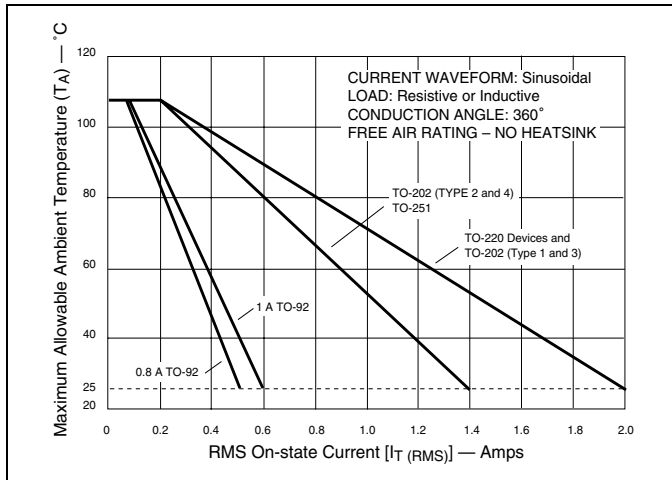

Figure E2.7 Maximum Allowable Ambient Temperature versus On-state Current

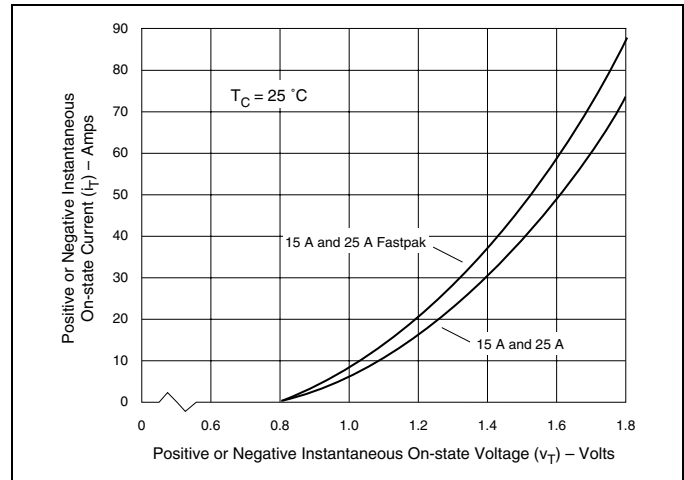

Figure E2.10 On-state Current versus On-state Voltage (Typical) (15 A and 25 A)

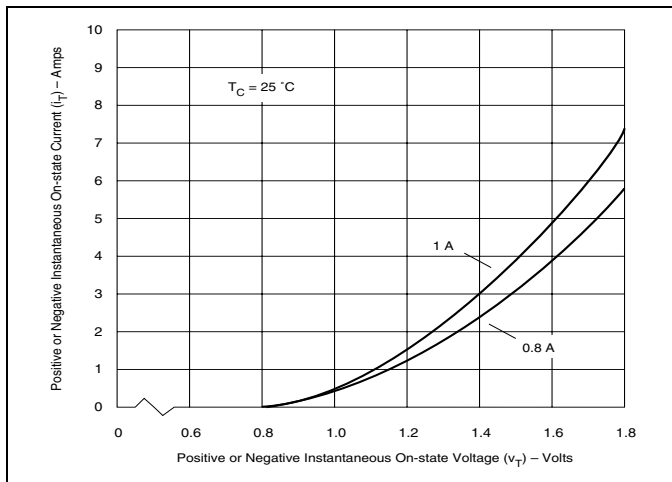

Figure E2.8 On-state Current versus On-state Voltage (Typical) (0.8 A and 1 A)

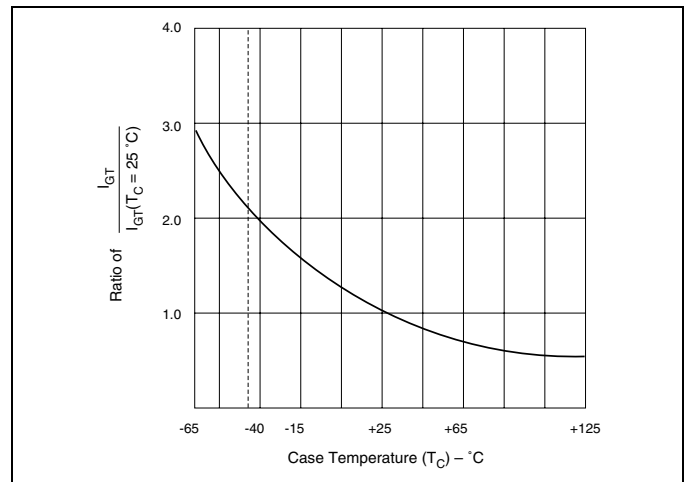

Figure E2.11 Normalized DC Gate Trigger Current for All Quadrants versus Case Temperature

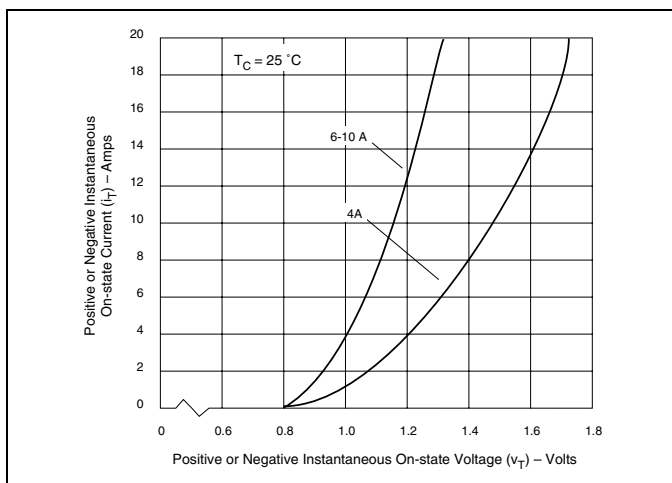

Figure E2.9 On-state Current versus On-state Voltage (Typical) (4 A, 6 A, 8 A, and 10 A)

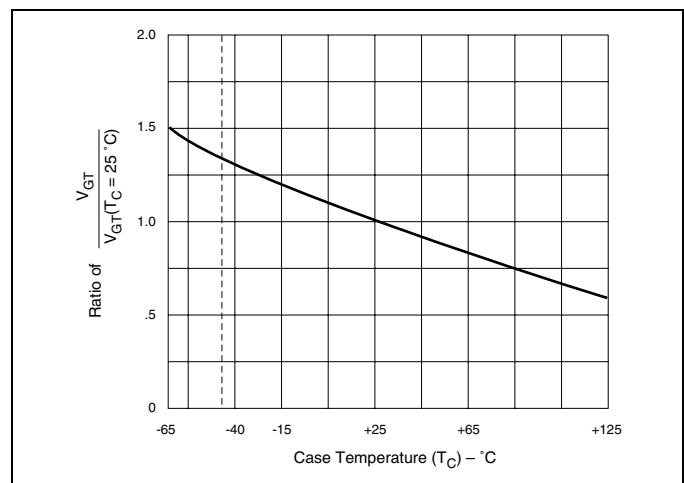

Figure E2.12 Normalized DC Gate Trigger Voltage for All Quadrants versus Case Temperature

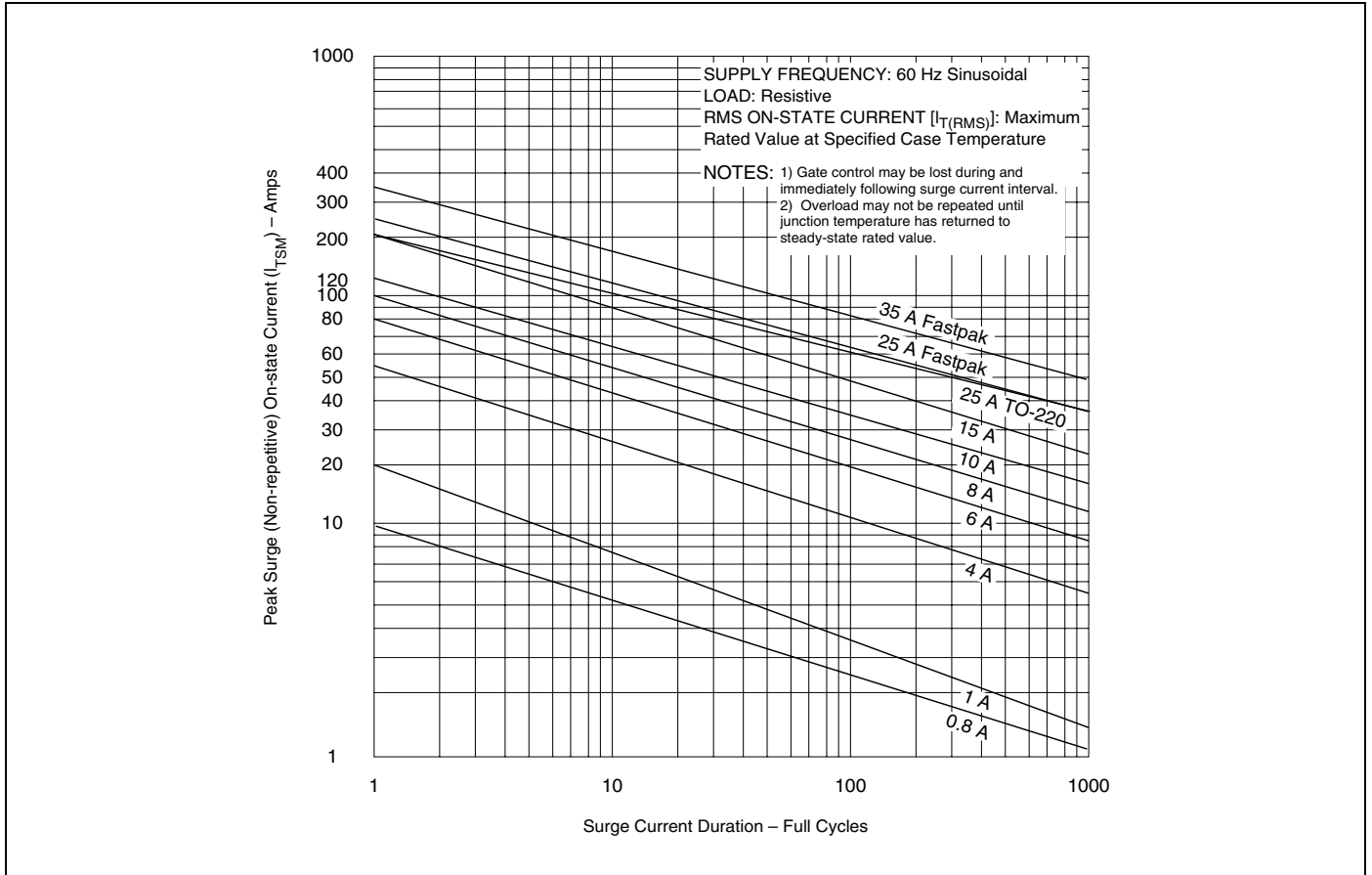

Figure E2.13 Peak Surge Current versus Surge Current Duration

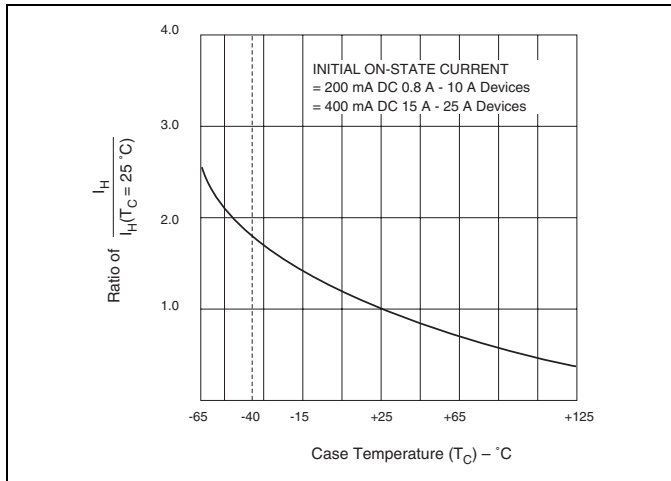

Figure E2.14 Normalized DC Holding Current versus Case Temperature

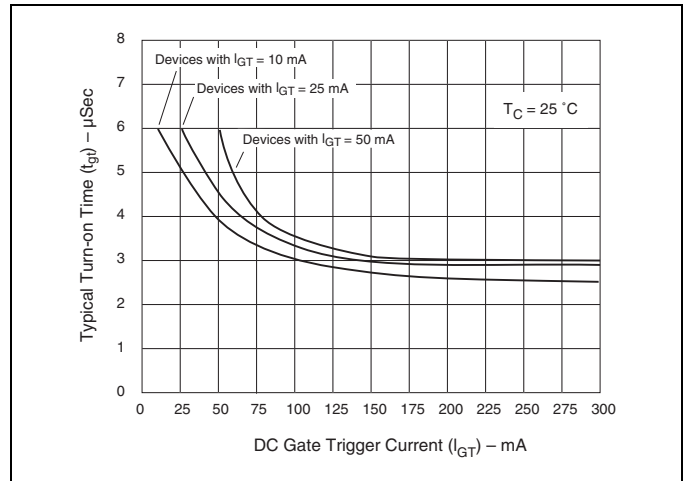

Figure E2.15 Turn-on Time versus Gate Trigger Current (Typical)

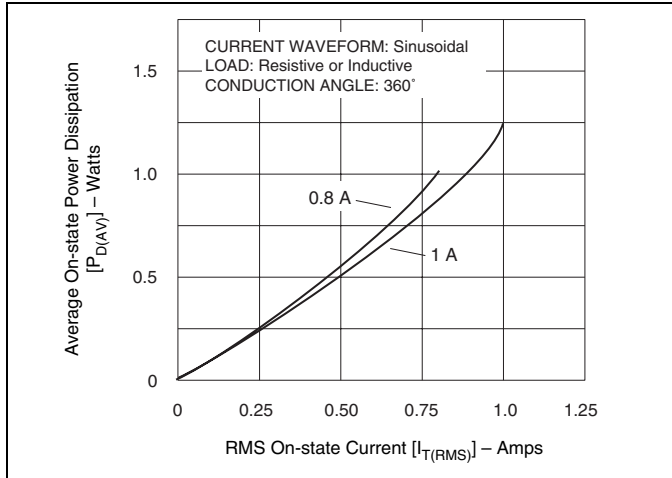

Figure E2.16 Power Dissipation (Typical) versus On-state Current (0.8 A and 1 A)

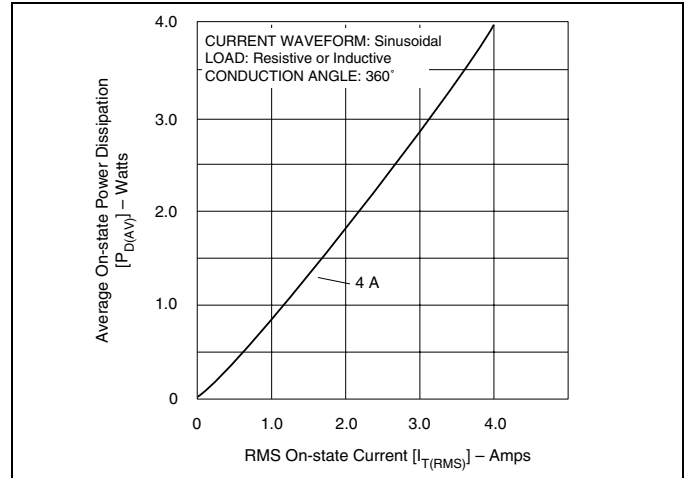

Figure E2.19 Power Dissipation (Typical) versus RMS On-state Current (4 A)

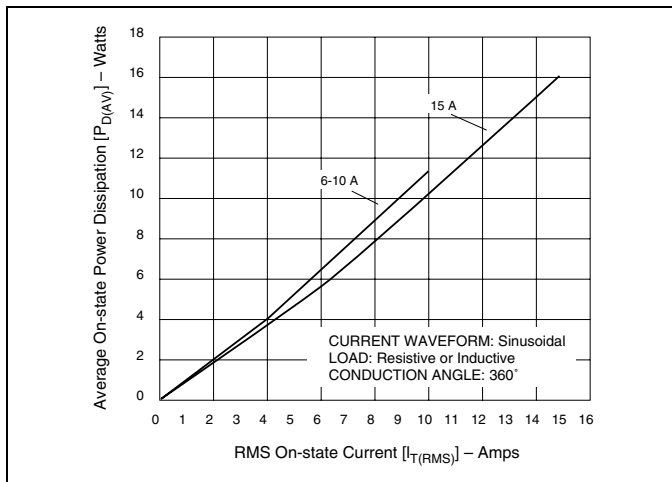

Figure E2.17 Power Dissipation (Typical) versus On-state Current (6 A to 10 A and 15 A)

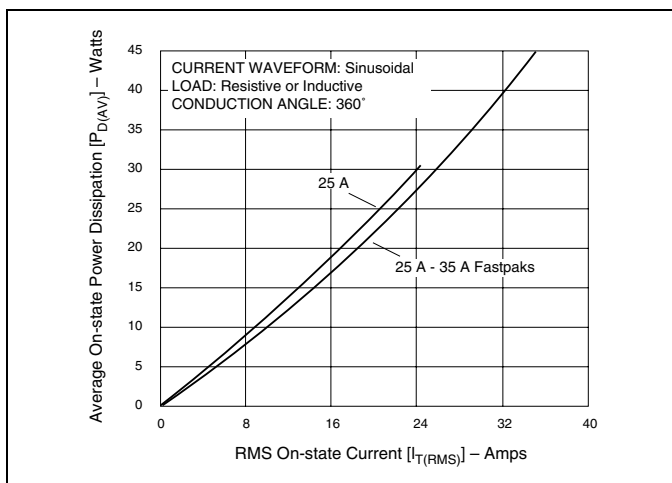
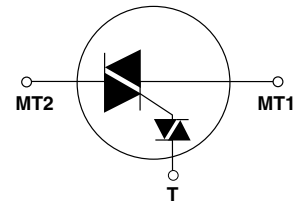
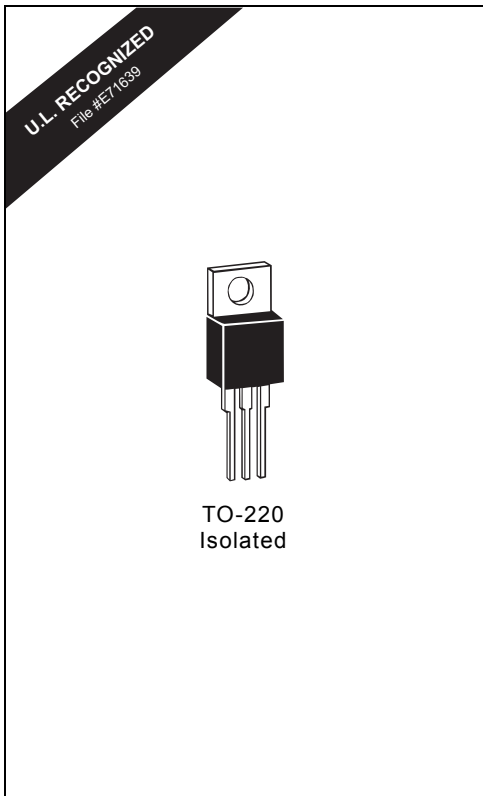

Figure E2.18 Power Dissipation (Typical) versus On-state Current (25 A to 35 A)



Quadrac

Internally Triggered Triacs (4 A to 15 A)

General Description

Teccor's *Quadrac* devices are triacs that include a diac trigger mounted inside the same package. This device, developed by Teccor, saves the user the expense and assembly time of buying a discrete diac and assembling in conjunction with a gated triac. Also, the alternistor *Quadrac* device (QxxxxLTH) eliminates the need for a snubber network.

The *Quadrac* device is a bidirectional AC switch and is gate controlled for either polarity of main terminal voltage. Its primary purpose is for AC switching and phase control applications such as speed controls, temperature modulation controls, and lighting controls where noise immunity is required.

Triac current capacities range from 4 A to 15 A with voltage ranges from 200 V to 600 V. *Quadrac* devices are available in the TO-220 package.

The TO-220 package is electrically isolated to 2500 V rms from the leads to mounting surface. 4000 V rms is available on special order. This means that no external isolation is required, thus eliminating the need for separate insulators and insulator-mounting steps and saving dollars over "hot tab" devices.

All Teccor triac and diac chips have glass-passivated junctions to ensure long-term device reliability and parameter stability.

Variations of devices in this data sheet are available for custom design applications. Consult the factory for more information.

Features

- Glass-passivated junctions
- Electrically-isolated package
- Internal trigger diac
- High surge capability — up to 200 A
- High voltage capability — 200 V to 600 V

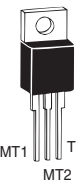
I _{T(RMS)} (5)	Part No.	V _{DRM} (1)	I _{DRM} (1) (10)			V _{TM} (1) (3)	Trigger Diac Specifications (T-MT1)					
	Isolated		mAmps				Volts	ΔV _{BO} (7)	V _{BO} (6)		[ΔV±] (6)	I _{BO} (11)
	 TO-220	Volts	T _C = 25 °C	T _C = 100 °C	T _C = 125 °C	T _C = 25 °C	Volts	Volts		Volts	μAmps	μFarads
See "Package Dimensions" section for variations. (12)			MIN	MAX			MAX	MAX	MIN	MAX	MIN	MAX
4 A	Q2004LT	200	0.05	0.5	2	1.6	3	33	43	5	25	0.1
	Q4004LT	400	0.05	0.5	2	1.6	3	33	43	5	25	0.1
	Q6004LT	600	0.05	0.5	2	1.6	3	33	43	5	25	0.1
6 A	Q2006LT	200	0.05	0.5	2	1.6	3	33	43	5	25	0.1
	Q4006LT	400	0.05	0.5	2	1.6	3	33	43	5	25	0.1
	Q6006LT	600	0.05	0.5	2	1.6	3	33	43	5	25	0.1
	Q4006LTH	400	0.05	0.5	2	1.6	3	33	43	5	25	0.1
	Q6006LTH	600	0.05	0.5	2	1.6	3	33	43	5	25	0.1
8 A	Q2008LT	200	0.05	0.5	2	1.6	3	33	43	5	25	0.1
	Q4008LT	400	0.05	0.5	2	1.6	3	33	43	5	25	0.1
	Q6008LT	600	0.05	0.5	2	1.6	3	33	43	5	25	0.1
	Q4008LTH	400	0.05	0.5	2	1.6	3	33	43	5	25	0.1
	Q6008LTH	600	0.05	0.5	2	1.6	3	33	43	5	25	0.1
10 A	Q2010LT	200	0.05	0.5	2	1.6	3	33	43	5	25	0.1
	Q4010LT	400	0.05	0.5	2	1.6	3	33	43	5	25	0.1
	Q6010LT	600	0.05	0.5	2	1.6	3	33	43	5	25	0.1
	Q4010LTH	400	0.05	0.5	2	1.6	3	33	43	5	25	0.1
	Q6010LTH	600	0.05	0.5	2	1.6	3	33	43	5	25	0.1
15 A	Q2015LT	200	0.05	0.5	2	1.6	3	33	43	5	25	0.1
	Q4015LT	400	0.05	0.5	2	1.6	3	33	43	5	25	0.1
	Q6015LT	600	0.05	0.5	2	1.6	3	33	43	5	25	0.1
	Q4015LTH	400	0.05	0.5	2	1.6	3	33	43	5	25	0.1
	Q6015LTH	600	0.05	0.5	2	1.6	3	33	43	5	25	0.1

Specific Test Conditions

- [ΔV±] — Dynamic breakback voltage (forward and reverse)
- ΔV_{BO} — Breakover voltage symmetry
- C_T — Trigger firing capacitance
- di/dt — Maximum rate-of-change of on-state current
- dv/dt — Critical rate-of-rise of off-state voltage at rated V_{DRM} gate open
- dv/dt(c) — Critical rate-of-rise of commutation voltage at rated V_{DRM} and I_{T(RMS)} commutating di/dt = 0.54 rated I_{T(RMS)}/ms; gate unenergized
- I²t — RMS surge (non-repetitive) on-state current for period of 8.3 ms for fusing
- I_{BO} — Peak breakover current
- I_{DRM} — Peak off-state current gate open; V_{DRM} = maximum rated value
- I_{GTM} — Peak gate trigger current (10 μs Max)
- I_H — Holding current; gate open
- I_{T(RMS)} — RMS on-state current, conduction angle of 360°
- I_{TSM} — Peak one-cycle surge
- t_{gt} — Gate controlled turn-on time
- V_{BO} — Breakover voltage (forward and reverse)

- V_{DRM} — Repetitive peak blocking voltage
- V_{TM} — Peak on-state voltage at maximum rated RMS current

General Notes

- All measurements are made at 60 Hz with resistive load at an ambient temperature of +25 °C unless otherwise specified.
- Operating temperature range (T_J) is -40 °C to +125 °C.
- Storage temperature range (T_S) is -40 °C to +125 °C.
- Lead solder temperature is a maximum of +230 °C for 10 seconds maximum; ≥1/16" (1.59 mm) from case.
- The case temperature (T_C) is measured as shown on dimensional outline drawings. See "Package Dimensions" section of this catalog.

Electrical Specification Notes

- (1) For either polarity of MT2 with reference to MT1
- (2) See Figure E3.1 for I_H versus T_C.
- (3) See Figure E3.4 and Figure E3.5 for i_T versus v_T.
- (4) See Figure E3.9 for surge ratings with specific durations.

I _H (1) (2)	I _{TSM} (4) (8)	dv/dt(c) (1) (5) (8)	dv/dt (1)		t _{gt} (6) (9)	I ² t	I _{GTM} Amps	di/dt (9)
			Volts/μSec					
			T _C = 100 °C	T _C = 125 °C				
mAmps	Amps	Volts/μSec			μSec	Amps ² Sec	Amps	Amps/μSec
MAX	60/50Hz	MIN	MIN		TYP			
40	55/46	3	75	50	3	12.5	1.2	50
40	55/46	3	75	50	3	12.5	1.2	50
40	55/46	3	50	50	3	12.5	1.2	50
50	80/65	4	150	100	3	26.5	1.5	70
50	80/65	4	150	100	3	26.5	1.5	70
50	80/65	4	125	85	3	26.5	1.5	70
50	80/65	25	575	450	3	26.5	1.5	70
50	80/65	25	425	350	3	26.5	1.5	70
60	100/83	4	175	120	3	41	1.5	70
60	100/83	4	175	120	3	41	1.5	70
60	100/83	4	150	100	3	41	1.5	70
60	100/83	25	575	450	3	41	1.5	70
60	100/83	25	425	350	3	41	1.5	70
60	120/100	4	200	150	3	60	1.5	70
60	120/100	4	200	150	3	60	1.5	70
60	120/100	4	175	120	3	60	1.5	70
60	120/100	30	925	700	3	60	1.5	70
60	120/100	30	775	600	3	60	1.5	70
70	200/167	4	300	200	3	166	1.5	100
70	200/167	4	300	200	3	166	1.5	100
70	200/167	4	200	150	3	166	1.5	100
70	200/167	30	925	700	3	166	1.5	100
70	200/167	30	775	600	3	166	1.5	100

- (5) See Figure E3.6, Figure E3.7, and Figure E3.8 for current rating at specific operating temperature.
- (6) See Figure E3.2 and Figure E3.3 for test circuit.
- (7) $\Delta V_{BO} = [+ V_{BO}] - [- V_{BO}]$
- (8) See Figure E3.7 and Figure E3.8 for maximum allowable case temperature at maximum rated current.
- (9) Trigger firing capacitance = 0.1 μF with 0.1 μs rise time
- (10) T_C = T_J for test conditions in off state
- (11) Maximum required value to ensure sufficient gate current
- (12) See package outlines for lead form configurations. When ordering special lead forming, add type number as suffix to part number.

Electrical Isolation

All Teccor isolated *Quadrac* packages withstand a minimum high potential test of 2500 V ac rms from leads to mounting tab over the operating temperature range of the device. The following isolation table shows standard and optional isolation ratings.

Electrical Isolation from Leads to Mounting Tab *	
V AC RMS	TYPE
2500	Standard
4000	Optional **

* UL Recognized File #E71639

**For 4000 V isolation, use "V" suffix in part number.

Thermal Resistance (Steady State) R _{θJC} [R _{θJA}] °C/W (TYP)	
TYPE	Isolated TO-220
4 A	3.6 [50]
6 A	3.3
8 A	2.8
10 A	2.6
15 A	2.1

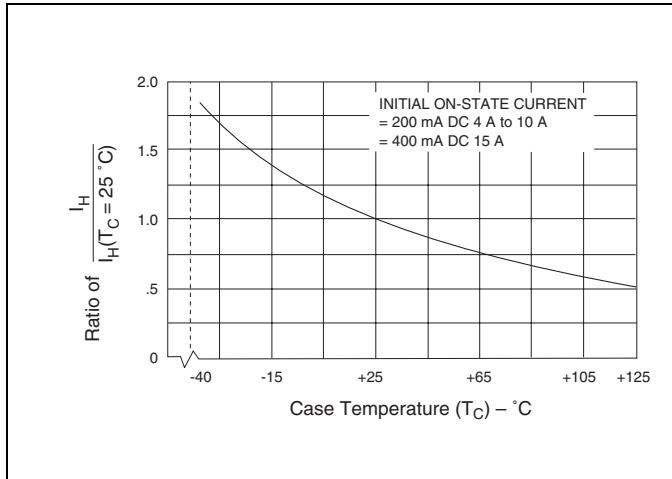

Figure E3.1 Normalized DC Holding Current versus Case Temperature

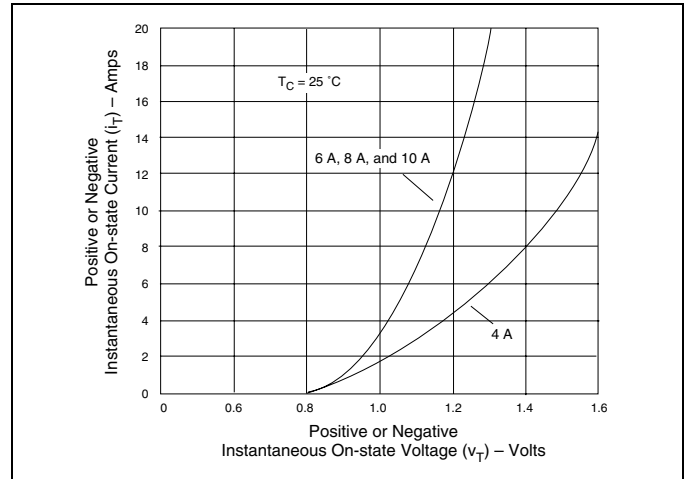

Figure E3.4 On-state Current versus On-state Voltage (Typical) (4 A to 10 A)

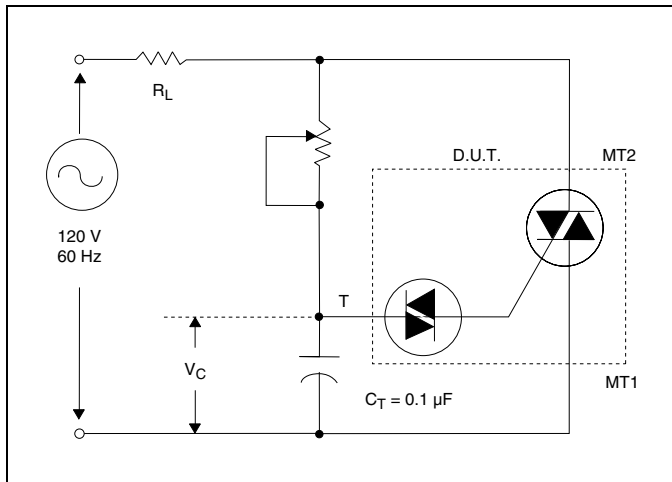

Figure E3.2 Test Circuit

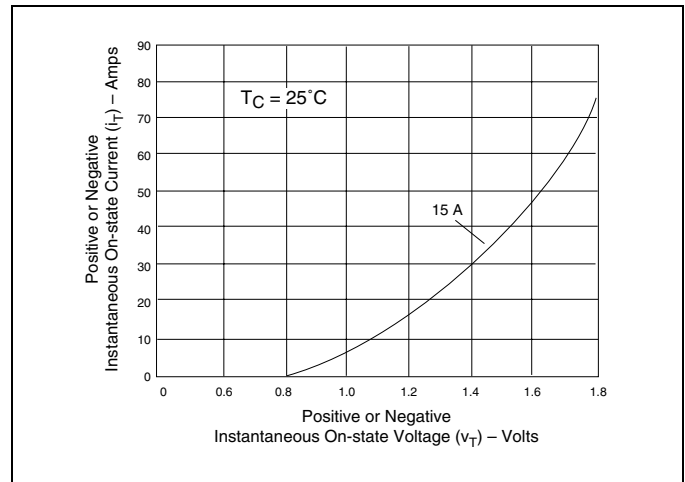

Figure E3.5 On-state Current versus On-state Voltage (Typical) (15 A)

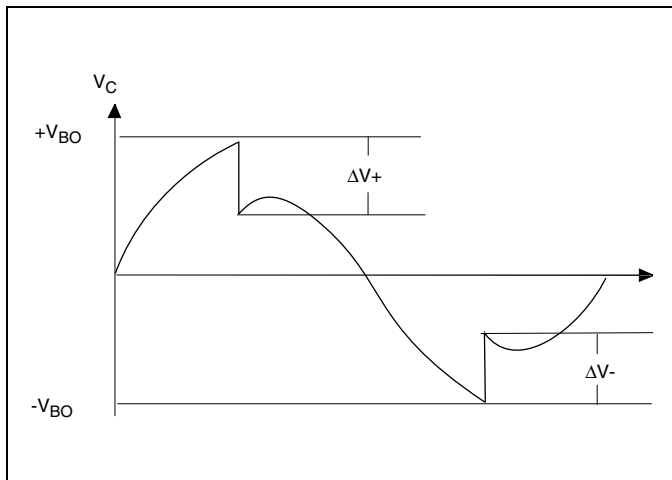

Figure E3.3 Test Circuit Waveforms

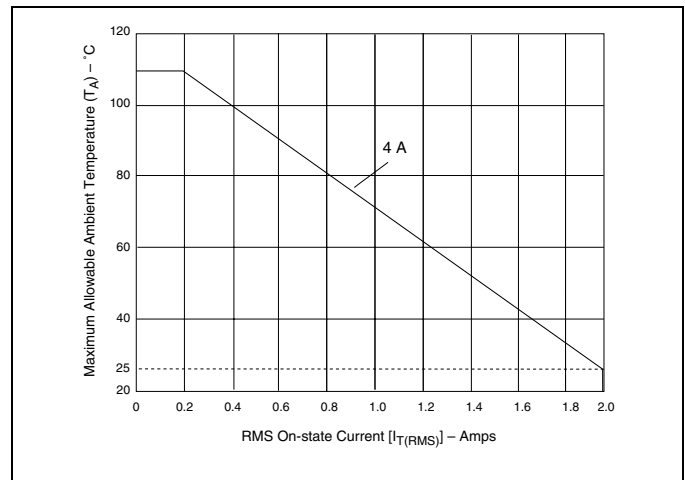

Figure E3.6 Maximum Allowable Ambient Temperature versus On-state Current

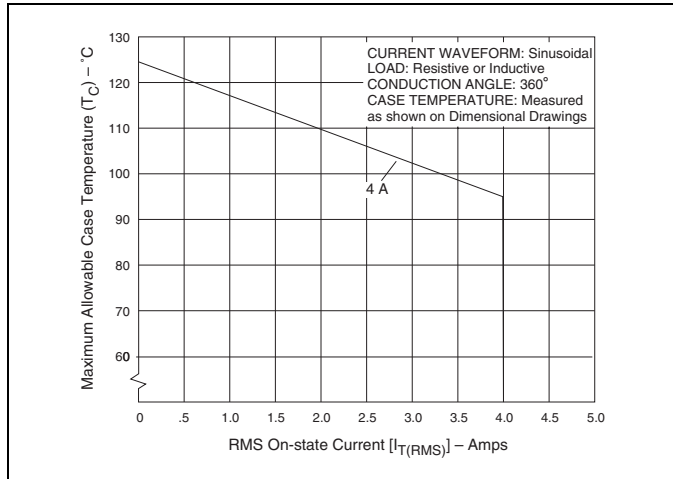

Figure E3.7 Maximum Allowable Case Temperature versus On-state Current (4 A)

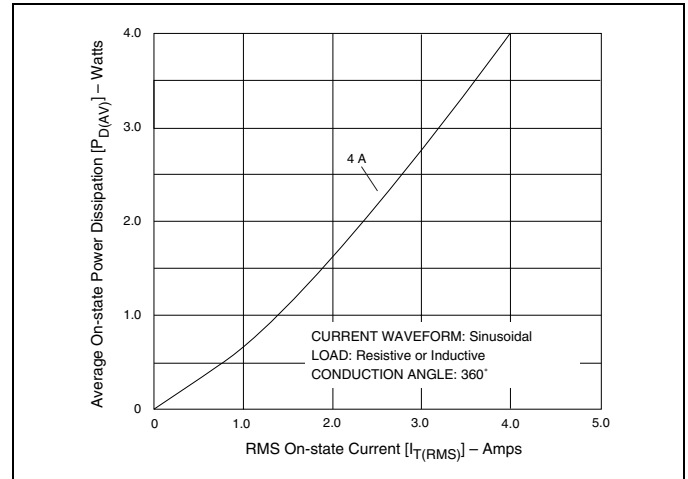

Figure E3.10 Power Dissipation (Typical) versus On-state Current (4 A)

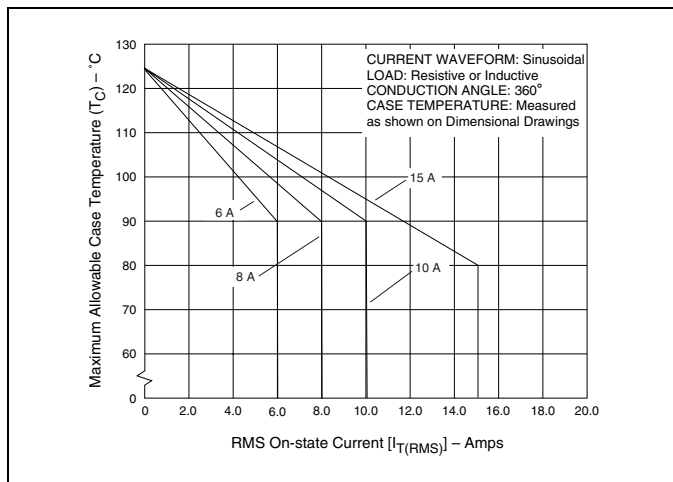

Figure E3.8 Maximum Allowable Case Temperature versus On-state Current (6 A to 15 A)

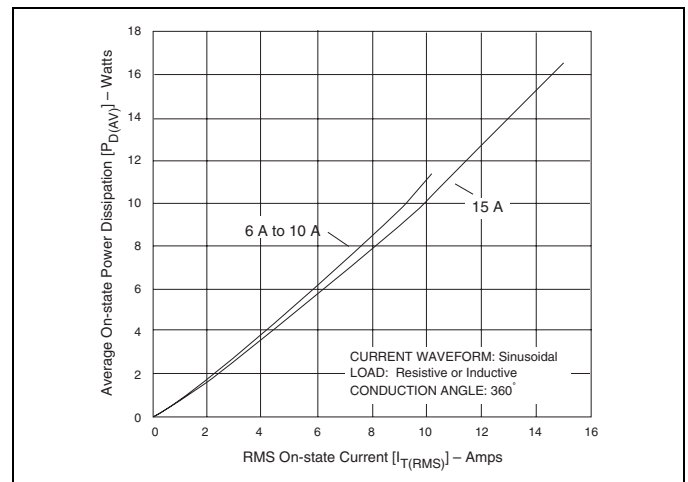

Figure E3.11 Power Dissipation (Typical) versus On-state Current (6 A to 10 A and 15 A)

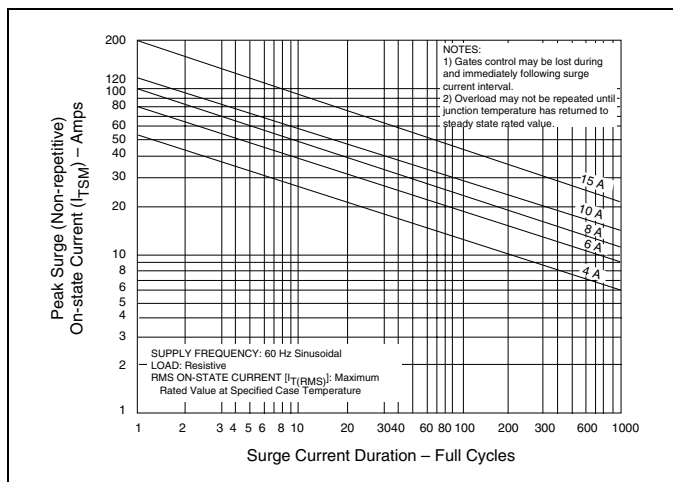

Figure E3.9 Peak Surge Current versus Surge Current Duration

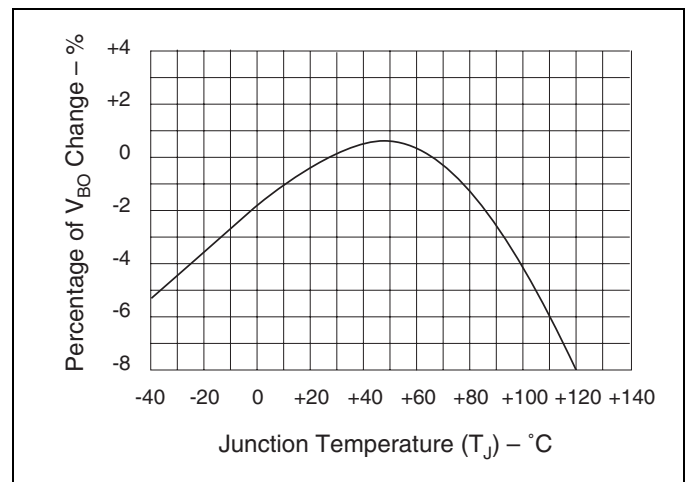
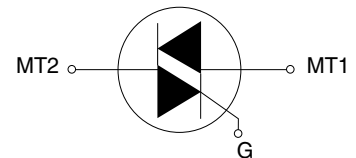
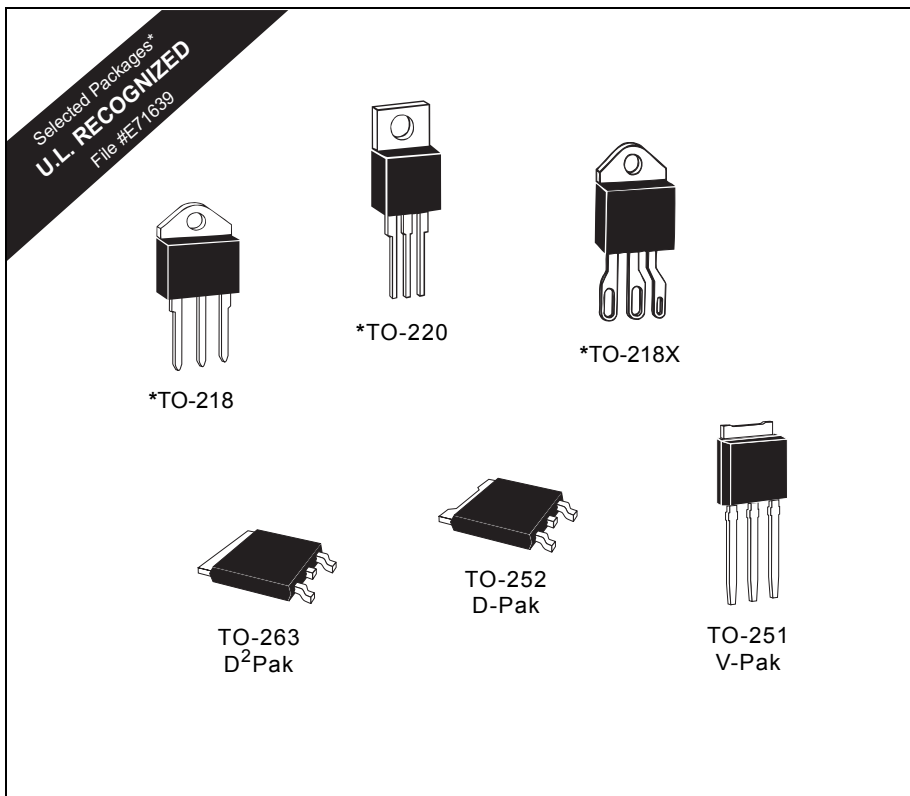

Figure E3.12 Normalized diac V_{BO} versus Junction Temperature



Alternistor Triacs

(6 A to 40 A)

General Description

Teccor offers bidirectional alternistors with current ratings from 6 A to 40 A and voltages from 200 V to 1000 V as part of Teccor's broad line of thyristors. Teccor's alternistor is specifically designed for applications that switch highly inductive loads. A special chip offers the same performance as two thyristors (SCRs) wired inverse parallel (back-to-back), providing better turn-off behavior than a standard triac. An alternistor may be triggered from a blocking to conduction state for either polarity of applied AC voltage with operating modes in Quadrants I, II, and III.

This new chip construction provides two electrically separate SCR structures, providing enhanced dv/dt characteristics while retaining the advantages of a single-chip device.

All alternistors have glass-passivated junctions to ensure long-term reliability and parameter stability. Teccor's glass-passivated junctions offer a reliable barrier against junction contamination.

Teccor's TO-218X package is designed for heavy, steady power-handling capability. It features large eyelet terminals for ease of soldering heavy gauge hook-up wire. All the isolated packages have a standard isolation voltage rating of 2500 V rms.

Variations of devices covered in this data sheet are available for custom design applications. Consult the factory for further information.

Features

- High surge current capability
- Glass-passivated junctions
- 2500 V ac isolation for L, J, and K Packages
- High commutating dv/dt
- High static dv/dt

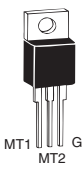
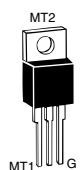
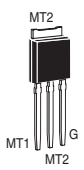
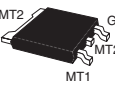
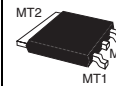
I _{T(RMS)}	Part Number					V _{DRM}	I _{GT}			I _{DRM}			
	Isolated	Non-isolated					mAmps			mAmps			
(4)(16)						(1)	(3)	(7)	(15)	(17)	(1)	(18)	
	T0-220	TO-220	TO-251 V-Pak	TO-252 D-Pak	TO-263 D²Pak	Volts	QI	QII	QIII	T _C = 25 °C	T _C = 100 °C	T _C = 125 °C	
MAX	See "Package Dimensions" section for variations. (11)					MIN	MAX			MAX			
6 A			Q2006VH3	Q2006DH3		200	10	10	10	0.01	0.5	2	
			Q4006VH3	Q4006DH3		400	10	10	10	0.01	0.5	2	
			Q6006VH3	Q6006DH3		600	10	10	10	0.01	0.5	2	
			Q8006VH3	Q8006DH3		800	10	10	10	0.01	0.5	2	
			QK006VH3	QK006DH3		1000	10	10	10	0.02	2		
			Q2006VH4	Q2006DH4		200	35	35	35	0.01	0.5	2	
			Q4006VH4	Q4006DH4		400	35	35	35	0.01	0.5	2	
			Q6006VH4	Q6006DH4		600	35	35	35	0.01	0.5	2	
			Q8006VH4	Q8006DH4		800	35	35	35	0.01	0.5	2	
			QK006VH4	QK006DH4		1000	35	35	35	0.02	2		
		Q2006LH4	Q2006RH4			Q2006NH4	200	35	35	35	0.01	0.5	2
		Q4006LH4	Q4006RH4			Q4006NH4	400	35	35	35	0.01	0.5	2
	Q6006LH4	Q6006RH4			Q6006NH4	600	35	35	35	0.01	0.5	2	
	Q8006LH4	Q8006RH4			Q8006NH4	800	35	35	35	0.01	0.5	2	
	QK006LH4	QK006RH4			QK006NH4	1000	35	35	35	0.02	3		
8 A			Q2008VH3	Q2008DH3		200	10	10	10	0.01	0.5	2	
			Q4008VH3	Q4008DH3		400	10	10	10	0.01	0.5	2	
			Q6008VH3	Q6008DH3		600	10	10	10	0.01	0.5	2	
			Q8008VH3	Q8008DH3		800	10	10	10	0.01	0.5	2	
			QK008VH3	QK008DH3		1000	10	10	10	0.02	2		
			Q2008VH4	Q2008DH4		200	35	35	35	0.01	0.5	2	
			Q4008VH4	Q4008DH4		400	35	35	35	0.01	0.5	2	
			Q6008VH4	Q6008DH4		600	35	35	35	0.01	0.5	2	
			Q8008VH4	Q8008DH4		800	35	35	35	0.01	0.5	2	
			QK008VH4	QK008DH4		1000	35	35	35	0.02	2		
		Q2008LH4	Q2008RH4			Q2008NH4	200	35	35	35	0.01	0.5	2
		Q4008LH4	Q4008RH4			Q4008NH4	400	35	35	35	0.01	0.5	2
	Q6008LH4	Q6008RH4			Q6008NH4	600	35	35	35	0.01	0.5	2	
	Q8008LH4	Q8008RH4			Q8008NH4	800	35	35	35	0.01	0.5	2	
	QK008LH4	QK008RH4			QK008NH4	1000	35	35	35	0.02	3		
10 A			Q2010LH5	Q2010RH5		Q2010NH5	200	50	50	50	0.01	0.5	2
			Q4010LH5	Q4010RH5		Q4010NH5	400	50	50	50	0.01	0.5	2
			Q6010LH5	Q6010RH5		Q6010NH5	600	50	50	50	0.01	0.5	2
			Q8010LH5	Q8010RH5		Q8010NH5	800	50	50	50	0.01	0.5	2
			QK010LH5	QK010RH5		QK010NH5	1000	50	50	50	0.02	3	
12 A			Q2012LH5	Q2012RH5		Q2012NH5	200	50	50	50	0.01	0.5	2
			Q4012LH5	Q4012RH5		Q4012NH5	400	50	50	50	0.01	0.5	2
			Q6012LH5	Q6012RH5		Q6012NH5	600	50	50	50	0.01	0.5	2
			Q8012LH5	Q8012RH5		Q8012NH5	800	50	50	50	0.01	0.5	2
			QK012LH5	QK012RH5		QK012NH5	1000	50	50	50	0.02	3	

See "General Notes" and "Electrical Specification Notes" on page E4 - 5.

V_{GT}	V_{TM}	I_H	I_{GT}	P_{GM}	P_{G(AV)}	I_{TSM}	dv/dt(c)	dv/dt		t_{gt}	I²t	di/dt
(2) (6) (15) (17) (20)	(1) (5)	(1) (8) (12)	(14)	(14)		(9) (13)	(1) (4) (13)	(1)		(10)		(19)
Volts						Amps		Volts/μSec				
T _C = 25 °C	Volts	mAmps	Amps	Watts	Watts	60/50 Hz	Volts/μSec	T _C = 100 °C	T _C = 125 °C	μSec	Amps ² Sec	Amps/μSec
MAX	MAX	MAX					MIN	MIN		TYP		
1.3	1.6	15	1.6	18	0.4	65/55	20	100	75	4	17.5	70
1.3	1.6	15	1.6	18	0.4	65/55	20	100	75	4	17.5	70
1.3	1.6	15	1.6	18	0.4	65/55	20	75	50	4	17.5	70
1.3	1.6	15	1.6	18	0.4	65/55	20	50	40	4	17.5	70
1.3	1.6	15	1.6	18	0.4	65/55	20	40		4	17.5	70
1.3	1.6	35	1.6	18	0.5	65/55	25	500	400	4	17.5	70
1.3	1.6	35	1.6	18	0.5	65/55	25	500	400	4	17.5	70
1.3	1.6	35	1.6	18	0.5	65/55	25	400	300	4	17.5	70
1.3	1.6	35	1.6	18	0.5	65/55	25	300	200	4	17.5	70
1.3	1.6	35	1.6	18	0.5	65/55	25	150		4	17.5	70
1.3	1.6	35	1.6	18	0.5	85/80	25	750	600	4	30	70
1.3	1.6	35	1.6	18	0.5	85/80	25	575	450	4	30	70
1.3	1.6	35	1.6	18	0.5	85/80	25	425	350	4	30	70
1.3	1.6	35	1.6	18	0.5	85/80	25	300	250	4	30	70
1.3	1.6	35	1.6	18	0.5	85/80	25	150		4	30	70
1.3	1.6	15	1.6	18	0.4	85/80	20	100	75	4	30	70
1.3	1.6	15	1.6	18	0.4	85/80	20	100	75	4	30	70
1.3	1.6	15	1.6	18	0.4	85/80	20	75	50	4	30	70
1.3	1.6	15	1.6	18	0.4	85/80	20	50	40	4	30	70
1.3	1.6	15	1.6	18	0.4	85/80	20	40		4	30	70
1.3	1.6	35	1.6	18	0.5	85/80	25	750	400	4	30	70
1.3	1.6	35	1.6	18	0.5	85/80	25	575	450	4	30	70
1.3	1.6	35	1.6	18	0.5	85/80	25	425	350	4	30	70
1.3	1.6	35	1.6	18	0.5	85/80	25	300	250	4	30	70
1.3	1.6	35	1.6	18	0.5	85/80	25	150		4	30	70
1.3	1.6	35	2	20	0.5	100/83	25	500	400	4	41	70
1.3	1.6	35	2	20	0.5	100/83	25	500	400	4	41	70
1.3	1.6	35	2	20	0.5	100/83	25	400	300	4	41	70
1.3	1.6	35	2	20	0.5	100/83	25	300	200	4	41	70
1.3	1.6	35	2	20	0.5	100/83	25	150		4	41	70
1.3	1.6	50	2	20	0.5	120/110	30	1150	1000	4	60	70
1.3	1.6	50	2	20	0.5	120/110	30	1000	750	4	60	70
1.3	1.6	50	2	20	0.5	120/110	30	850	650	4	60	70
1.3	1.6	50	2	20	0.5	120/110	30	650	500	4	60	70
1.3	1.6	50	2	20	0.5	120/110	30	300		4	60	70
1.3	1.6	50	2	20	0.5	120/110	30	1150	1000	4	60	70
1.3	1.6	50	2	20	0.5	120/110	30	1000	750	4	60	70
1.3	1.6	50	2	20	0.5	120/110	30	850	650	4	60	70
1.3	1.6	50	2	20	0.5	120/110	30	650	500	4	60	70
1.3	1.6	50	2	20	0.5	120/110	30	300		4	60	70

See "General Notes" and "Electrical Specification Notes" on page E4 - 5.

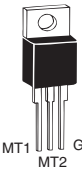
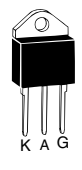
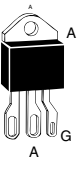
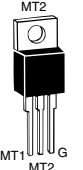
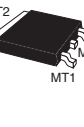
I _{T(RMS)} (4)(16)	Part Number					V _{DRM} (1)	I _{GT} (3) (7) (15) (17)		
	Isolated			Non-isolated			mAmps		
	 MT1 MT2 G TO-220	 K A G TO-218 (16)	 A K A G A TO-218X	 MT2 MT1 MT2 G TO-220	 MT2 G MT1 TO-263 D²Pak	Volts			
MAX	See "Package Dimensions" section for variations. (11)						MAX		
16 A	Q2016LH3			Q2016RH3	Q2016NH3	200	20	20	20
	Q4016LH3			Q4016RH3	Q4016NH3	400	20	20	20
	Q6016LH3			Q6016RH3	Q6016NH3	600	20	20	20
	Q8016LH3			Q8016RH3	Q8016NH3	800	20	20	20
	QK016LH3			QK016RH3	QK016NH3	1000	20	20	20
	Q2016LH4			Q2016RH4	Q2016NH4	200	35	35	35
	Q4016LH4			Q4016RH4	Q4016NH4	400	35	35	35
	Q6016LH4			Q6016RH4	Q6016NH4	600	35	35	35
	Q8016LH4			Q8016RH4	Q8016NH4	800	35	35	35
	QK016LH4			QK016RH4	QK016NH4	1000	35	35	35
	Q2016LH6			Q2016RH6	Q2016NH6	200	80	80	80
	Q4016LH6			Q4016RH6	Q4016NH6	400	80	80	80
Q6016LH6			Q6016RH6	Q6016NH6	600	80	80	80	
Q8016LH6			Q8016RH6	Q8016NH6	800	80	80	80	
QK016LH6			QK016RH6	QK016NH6	1000	80	80	80	
25 A	Q2025L6	Q2025K6	Q2025J6	Q2025R6	Q2025NH6	200	80	80	80
	Q4025L6	Q4025K6	Q4025J6	Q4025R6	Q4025NH6	400	80	80	80
	Q6025L6	Q6025K6	Q6025J6	Q6025R6	Q6025NH6	600	80	80	80
	Q8025L6	Q8025K6	Q8025J6	Q8025R6	Q8025NH6	800	80	80	80
	QK025L6	QK025K6		QK025R6	QK025NH6	1000	80	80	80
30 A	Q2030LH5					200	50	50	50
	Q4030LH5					400	50	50	50
	Q6030LH5					600	50	50	50
35 A				Q2035RH5	Q2035NH5	200	50	50	50
				Q4035RH5	Q4035NH5	400	50	50	50
				Q6035RH5	Q6035NH5	600	50	50	50
40 A		Q2040K7	Q2040J7			200	100	100	100
		Q4040K7	Q4040J7			400	100	100	100
		Q6040K7	Q6040J7			600	100	100	100
		Q8040K7	Q8040J7			800	100	100	100
		QK040K7				1000	100	100	100

See "General Notes" and "Electrical Specification Notes" on page E4 - 5.

Test Conditions

- di/dt** — Maximum rate-of-change of on-state current
- dv/dt** — Critical rate-of-rise of off-state voltage at rated V_{DRM} gate open
- dv/dt(c)** — Critical rate-of-rise of commutation voltage at rated V_{DRM} and I_{T(RMS)} commutating di/dt = 0.54 rated I_{T(RMS)}/ms; gate unenergized
- I²t** — RMS surge (non-repetitive) on-state current for period of 8.3 ms for fusing
- I_{DRM}** — Peak off-state current gate open; V_{DRM} = maximum rated value
- I_{GT}** — DC gate trigger current in specific operating quadrants; V_D = 12 V dc
- I_{GTM}** — Peak gate trigger current

- I_H** — Holding current (DC); gate open
- I_{T(RMS)}** — RMS on-state current conduction angle of 360°
- I_{TSM}** — Peak one-cycle surge
- P_{G(AV)}** — Average gate power dissipation
- P_{GM}** — Peak gate power dissipation; I_{GT} ≤ I_{GTM}
- t_{gt}** — Gate controlled turn-on time; I_{GT} = 300 mA with 0.1 μs rise time
- V_{DRM}** — Repetitive peak blocking voltage
- V_{GT}** — DC gate trigger voltage; V_D = 12 V dc
- V_{TM}** — Peak on-state voltage at maximum rated RMS current

I _{DRM}			V _{GT}	V _{TM}	I _H	I _{GT}	P _{GM}	P _{G(AV)}	I _{TSM}	dv/dt(c)	dv/dt		t _{gt}	I ² t	di/dt
(1) (18)			(2) (6) (15) (17) (20)	(1) (5)	(1) (8) (12)	(14)	(14)		(9) (13)	(1) (4) (13)	(1)		(10)		(19)
mAmps			Volts	Volts					Amps		Volts/μSec				
T _C = 25 °C	T _C = 100 °C	T _C = 125 °C	T _C = 25 °C	T _C = 25 °C	mAmps	Amps	Watts	Watts	60/50 Hz	Volts/μSec	T _C = 100 °C	T _C = 125 °C	μSec	Amps ² Sec	Amps/μSec
MAX			MAX	MAX	MAX					MIN	MIN		TYP		
0.05	0.5	2	1.5	1.6	35	2	20	0.5	200/167	20	500	400	3	166	100
0.05	0.5	27	1.5	1.6	35	2	20	0.5	200/167	20	400	350	3	166	100
0.05	0.5	2	1.5	1.6	35	2	20	0.5	200/167	20	300	250	3	166	100
0.1	1	3	1.5	1.6	35	2	20	0.5	200/167	20	275	200	3	166	100
0.1	3		1.5	1.6	35	2	20	0.5	200/167	20	200		3	166	100
0.05	0.5	2	2	1.6	50	2	20	0.5	200/167	25	650	500	3	166	100
0.05	0.5	2	2	1.6	50	2	20	0.5	200/167	25	600	475	3	166	100
0.05	0.5	2	2	1.6	50	2	20	0.5	200/167	25	500	400	3	166	100
0.1	1	3	2	1.6	50	2	20	0.5	200/167	25	425	350	3	166	100
0.1	3		2	1.6	50	2	20	0.5	200/167	25	300		3	166	100
0.05	0.5	2	2.5	1.6	70	2	20	0.5	200/167	30	875	600	5	166	100
0.05	0.5	2	2.5	1.6	70	2	20	0.5	200/167	30	875	600	5	166	100
0.05	0.5	2	2.5	1.6	70	2	20	0.5	200/167	30	800	520	5	166	100
0.1	1	3	2.5	1.6	70	2	20	0.5	200/167	30	700	475	5	166	100
0.1	3		2.5	1.6	70	2	20	0.5	200/167	30	350		5	166	100
0.05	0.5	2	2.5	1.8	100	2	20	0.5	250/208	30	875	600	5	259	100
0.05	0.5	2	2.5	1.8	100	2	20	0.5	250/208	30	875	600	5	259	100
0.05	0.5	2	2.5	1.8	100	2	20	0.5	250/208	30	800	520	5	259	100
0.1	1	3	2.5	1.8	100	2	20	0.5	250/208	30	700	475	5	259	100
0.1	3		2.5	1.8	100	2	20	0.5	250/208	30	400		5	259	100
0.05	0.5	2	2	1.4	75	2	20	0.5	350/290	20	650	500	3	508	100
0.05	0.5	2	2	1.4	75	2	20	0.5	350/290	20	600	475	3	508	100
0.05	0.5	2	2	1.4	75	2	20	0.5	350/290	20	500	400	3	508	100
0.05	0.5	2	2	1.5	75	2	20	0.5	350/290	20	650	500	3	508	100
0.05	0.5	2	2	1.5	75	2	20	0.5	350/290	20	600	475	3	508	100
0.05	0.5	2	2	1.5	75	2	20	0.5	350/290	20	500	400	3	508	100
0.2	2	5	2.5	1.8	120	4	40	0.8	400/335	50	1100	700	5	664	150
0.2	2	5	2.5	1.8	120	4	40	0.8	400/335	50	1100	700	5	664	150
0.2	2	5	2.5	1.8	120	4	40	0.8	400/335	50	1000	625	5	664	150
0.2	2	5	2.5	1.8	120	4	40	0.8	400/335	50	900	575	5	664	150
0.2	5		2.5	1.8	120	4	40	0.8	400/335	50	500		5	664	150

General Notes

- All measurements are made at 60 Hz with a resistive load at an ambient temperature of +25 °C unless specified otherwise.
- Operating temperature range (T_J) is -40 °C to +125 °C.
- Storage temperature range (T_S) is -40 °C to +125 °C.
- Lead solder temperature is a maximum of 230 °C for 10 seconds maximum ≥1/16" (1.59 mm) from case.
- The case temperature (T_C) is measured as shown in the dimensional outline drawings. See "Package Dimensions" section.

Electrical Specification Notes

- For either polarity of MT2 with reference to MT1 terminal
- For either polarity of gate voltage (V_{GT}) with reference to MT1 terminal
- See Gate Characteristics and Definition of Quadrants.
- See Figure E4.1 through Figure E4.4 for current rating at specific operating temperature and Figure 4.16 for free air rating (no heat sink).
- See Figure E4.5 and Figure E4.6 for I_T and V_T.
- See Figure E4.7 for V_{GT} versus T_C.
- See Figure E4.8 for I_{GT} versus T_C.
- See Figure E4.9 for I_H versus T_C.
- See Figure E4.10 and Figure E4.11 for surge rating with specific durations.

- (10) See Figure E4.12 for t_{GT} versus I_{GT} .
- (11) See package outlines for lead form configurations. When ordering special lead forming, add type number as suffix to part number.
- (12) Initial on-state current = 400 mA dc for 16 A to 40 A devices and 100 mA for 6 A to 12 A devices.
- (13) See Figure E4.1 through Figure E4.4 for maximum allowable case temperature at maximum rated current.
- (14) Pulse width $\leq 10 \mu s$; $I_{GT} \leq I_{GTM}$
- (15) For 6 A to 12 A devices, $R_L = 60 \Omega$; 16 A and above, $R_L = 30 \Omega$
- (16) 40 A pin terminal leads on K package can run 100 °C to 125 °C.
- (17) Alternistor does not turn on in Quadrant IV.
- (18) $T_C = T_J$ for test conditions in off state
- (19) $I_{GT} = 200 \text{ mA}$ for 6 A to 12 A devices and 500 mA for 16 A to 40 A devices with gate pulse having rise time of $\leq 0.1 \mu s$.
- (20) Minimum non-trigger V_{GT} at 125 °C is 0.2 V.

Gate Characteristics

Teccor triacs may be turned on in the following ways:

- In-phase signals (with standard AC line) using Quadrants I and III
- Application of unipolar pulses (gate always negative), using Quadrants II and III with negative gate pulses

In all cases, if maximum surge capability is required, gate pulses should be a minimum of one magnitude above minimum I_{GT} rating with a steep rising waveform ($\leq 1 \mu s$ rise time).

If QIV and QI operation is required (gate always positive), see Figure AN1002.8, "Amplified Gate" Thyristor Circuit.

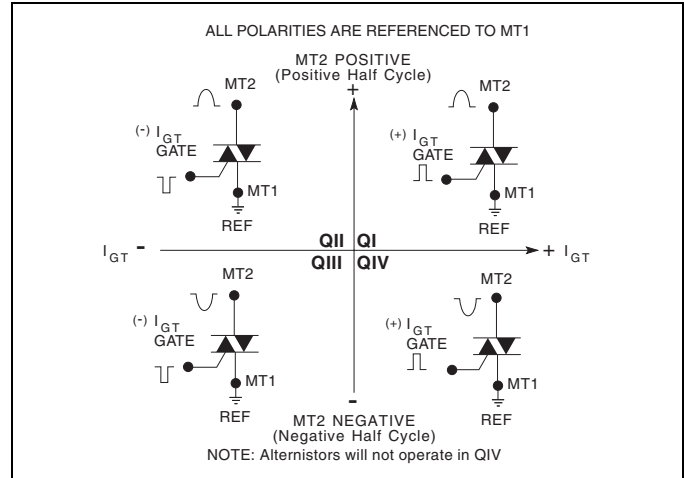

Definition of Quadrants



Electrical Isolation

Teccor's isolated alternistor packages withstand a minimum high potential test of 2500 V ac rms from leads to mounting tab, over the operating temperature range of the device. The following isolation table shows standard and optional isolation ratings.

Electrical Isolation from Leads to Mounting Tab *			
V AC RMS	TO-218 Isolated	TO-220 Isolated	TO-218X Isolated
2500	Standard	Standard	Standard
4000	N/A	Optional **	N/A

* UL Recognized File E71639

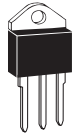
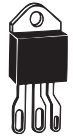
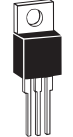
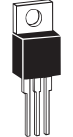
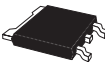
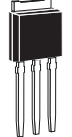
** For 4000 V isolation, use V suffix in part number.

Thermal Resistance (Steady State) $R_{\theta JC} [R_{\theta JA}]$ (TYP.) °C/W							
Package Code	K	J	L	R	D	V	N
Type	 TO-218 Isolated *	 TO-218X Isolated *	 TO-220 Isolated **	 TO-220 Non-Isolated	 TO-252 D-Pak	 TO-251 V-Pak	 TO-263 D ² Pak
6 A			3.3 [50]	1.80 [45]	2.1	2.3 [64]	1.80
8 A			2.8	1.50	1.8	2.1	1.50
10 A			2.6	1.30			1.30
12 A			2.3	1.20			1.20
16 A			2.1	1.10			1.10
25 A	1.35	1.32	2.0	0.87			0.87
30 A			2.3				
35 A				0.85			
40 A	0.97	0.95					

* UL Recognized Product per UL File E71639

** For 4000 V isolation, use V suffix in part number.

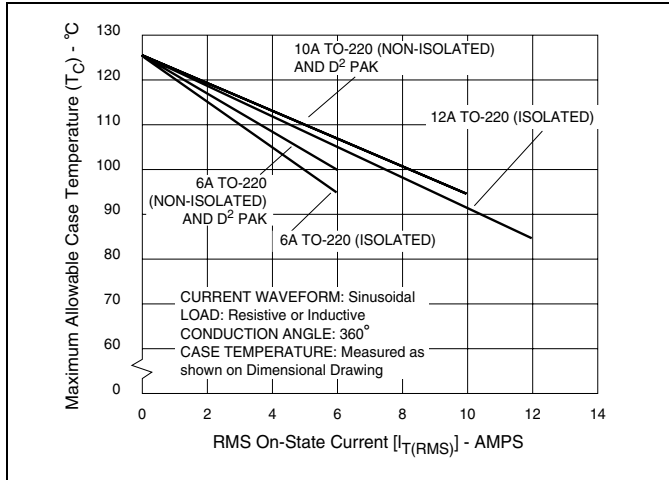

Figure E4.1 Maximum Allowable Case Temperature versus On-state Current (6 A to 12 A)

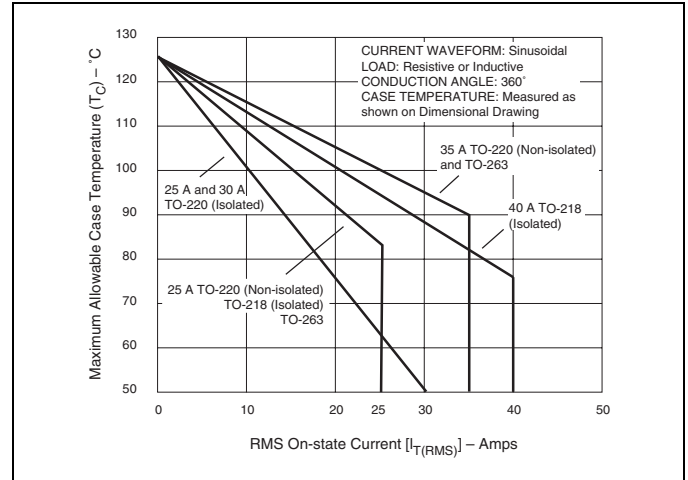

Figure E4.4 Maximum Allowable Case Temperature versus On-state Current (25 A to 40 A)

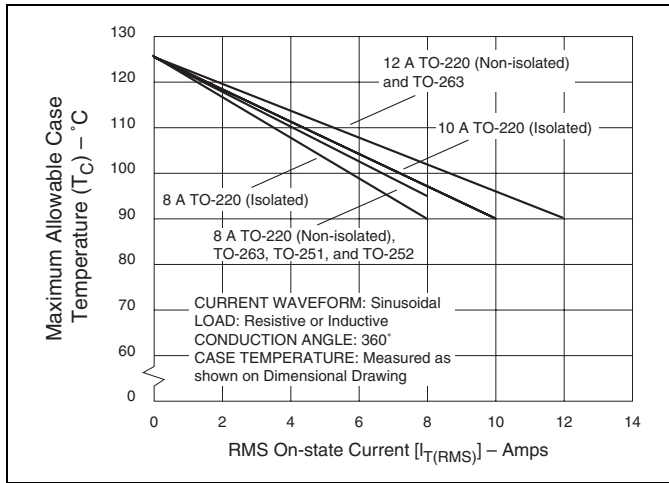

Figure E4.2 Maximum Allowable Case Temperature versus On-state Current (8 A to 12 A)

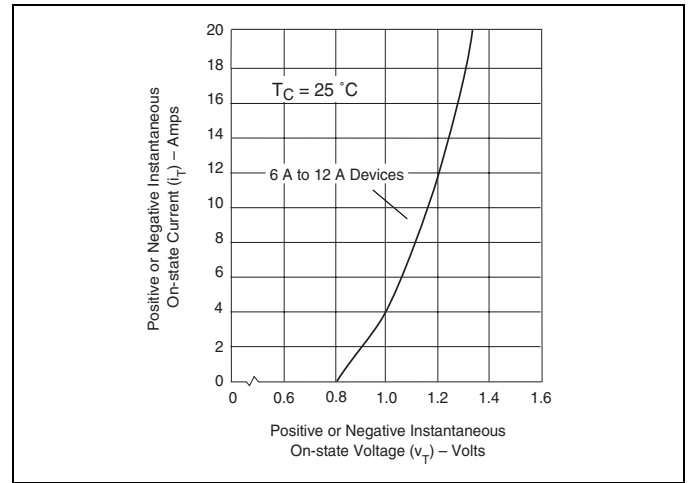

Figure E4.5 On-state Current versus On-state Voltage (Typical) (6 A to 12 A)

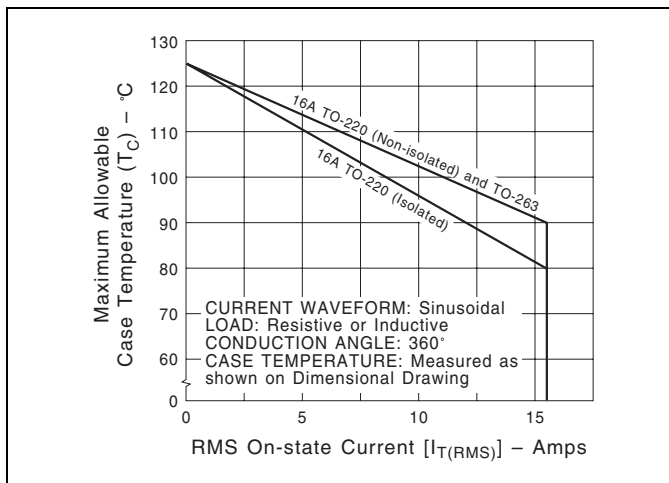

Figure E4.3 Maximum Allowable Case Temperature versus On-state Current (16 A)

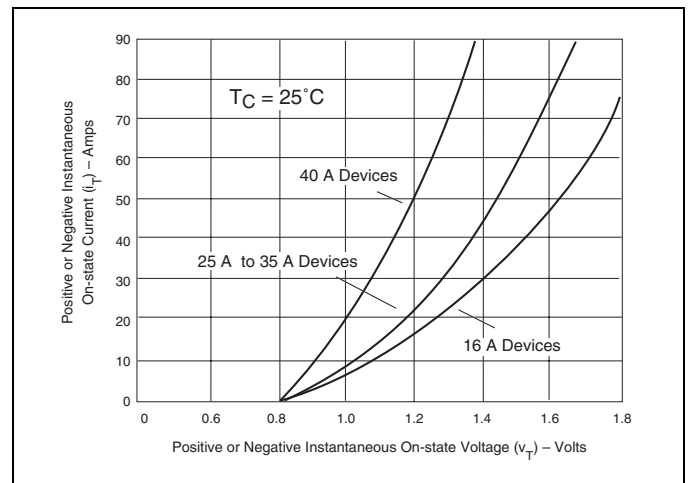

Figure E4.6 On-state Current versus On-state Voltage (Typical) (16 A to 40 A)

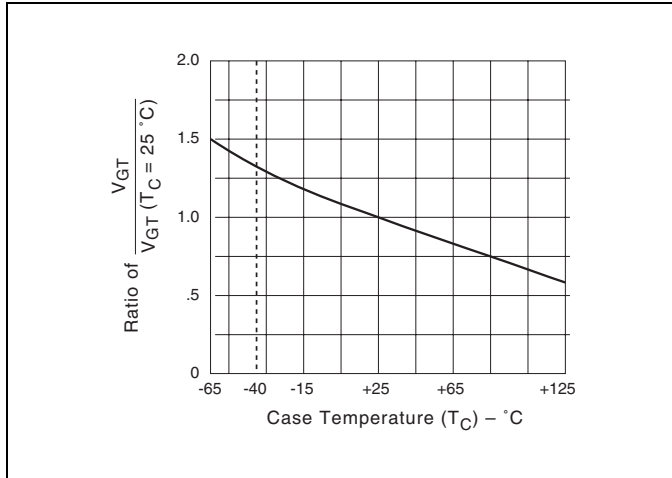

Figure E4.7 Normalized DC Gate Trigger Voltage for all Quadrants versus Case Temperature

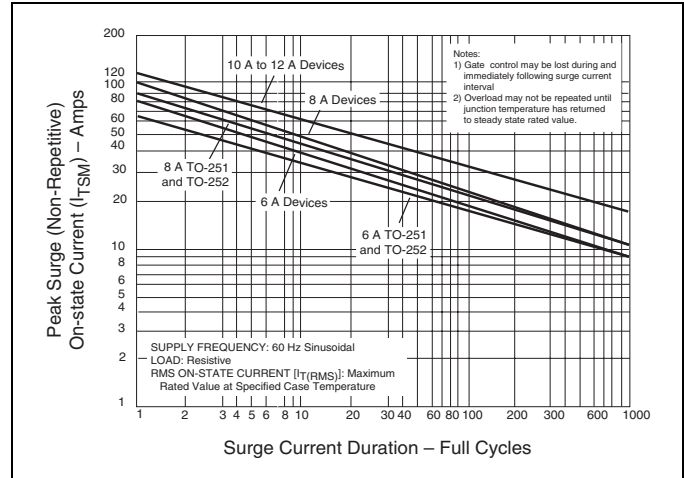

Figure E4.10 Peak Surge Current versus Surge Current Duration (6 A to 12 A)

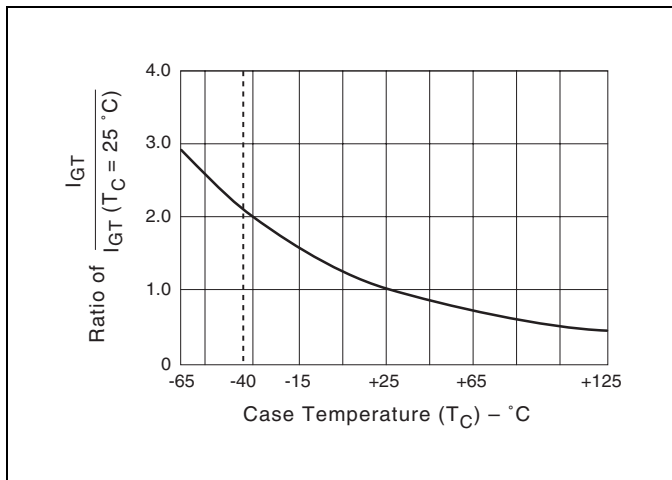

Figure E4.8 Normalized DC Gate Trigger Current for all Quadrants versus Case Temperature

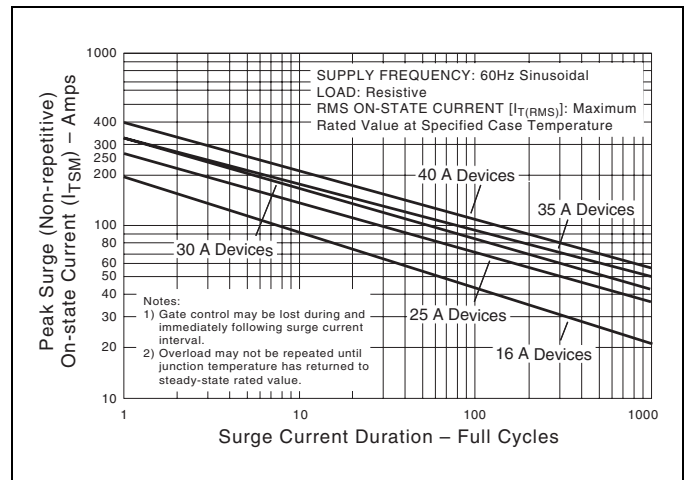

Figure E4.11 Peak Surge Current versus Surge Current Duration (16 A to 40 A)

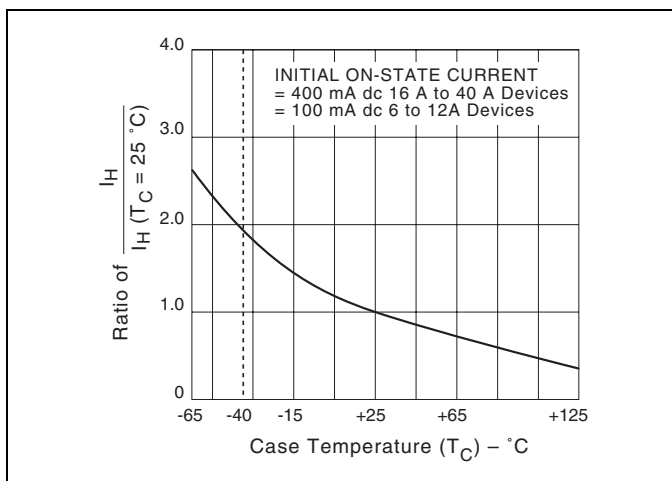

Figure E4.9 Normalized DC Holding Current versus Case Temperature

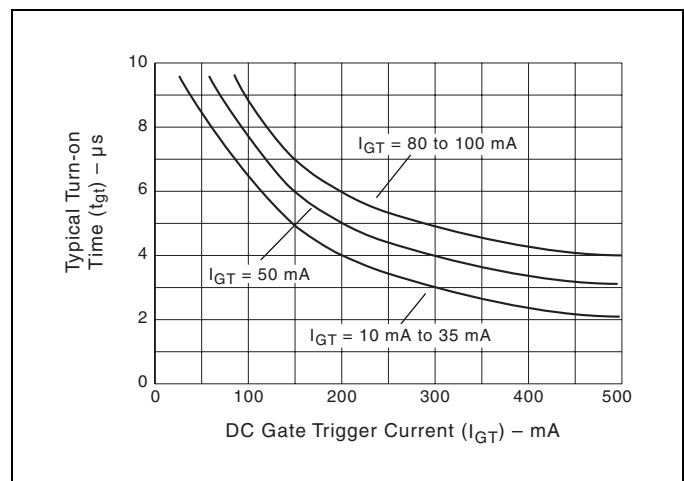

Figure E4.12 Turn-on Time versus Gate Trigger Current (Typical)

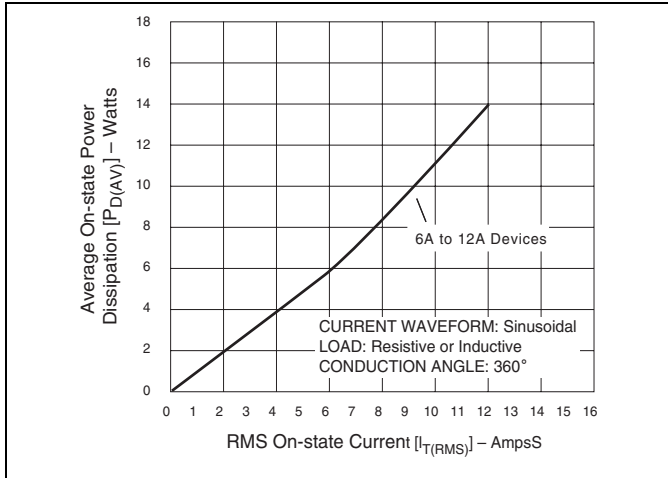

Figure E4.13 Power Dissipation (Typical) versus On-state Current (6 A to 12 A)

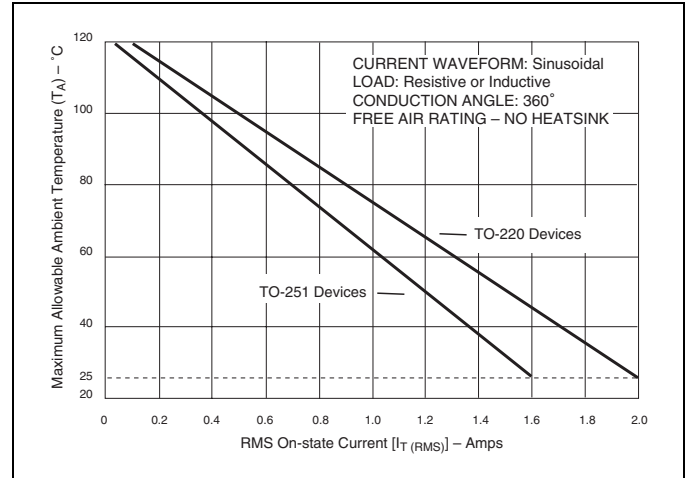

Figure E4.16 Maximum Allowable Ambient Temperature versus On-state Current

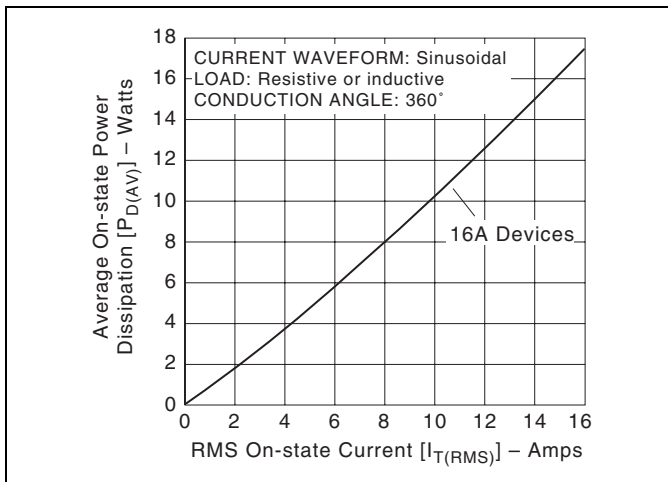

Figure E4.14 Power Dissipation (Typical) versus On-state Current (16 A)

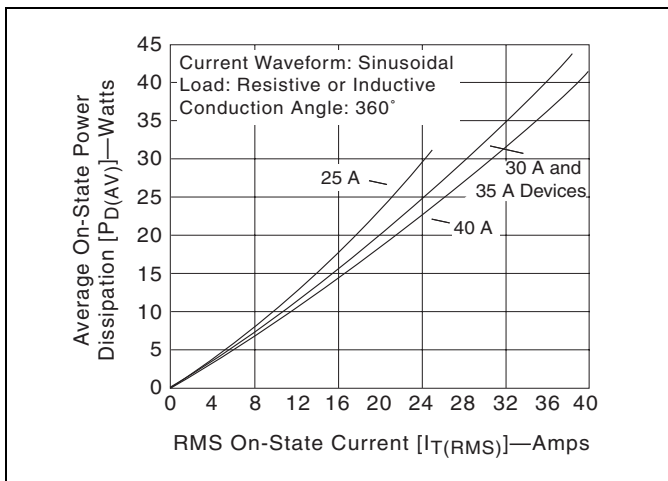
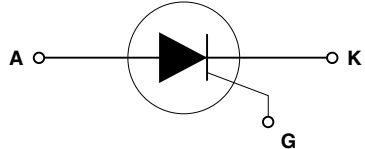
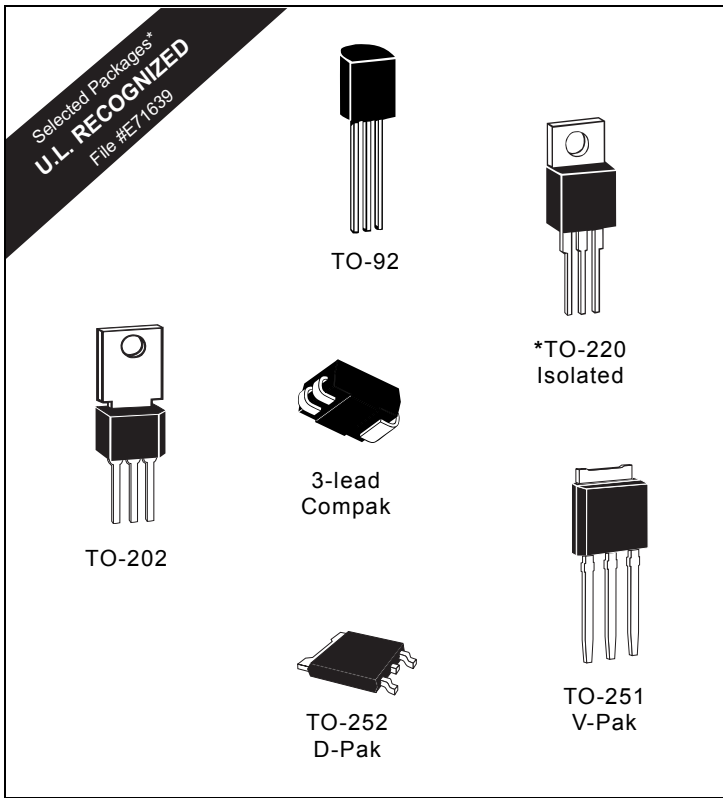

Figure E4.15 Power Dissipation (Typical) versus On-state Current (25 A to 40 A)



Sensitive SCRs

(0.8 A to 10 A)

General Description

The Teccor line of sensitive SCR semiconductors are half-wave unidirectional, gate-controlled rectifiers (SCR-thyristor) which complement Teccor's line of power SCRs. This group of packages offers ratings of 0.8 A to 10 A, and 200 V to 600 V with gate sensitivities of 12 μ A to 500 μ A. For gate currents in the 10 mA to 50 mA ranges, see "SCRs" section of this catalog.

The TO-220 and TO-92 are electrically isolated where the case or tab is internally isolated to allow the use of low-cost assembly and convenient packaging techniques.

Teccor's line of SCRs features glass-passivated junctions to ensure long-term device reliability and parameter stability. Teccor's glass offers a rugged, reliable barrier against junction contamination.

Tape-and-reel packaging is available for the TO-92 package. Consult the factory for more information.





Variations of devices covered in this data sheet are available for custom design applications. Consult the factory for more information.

Features

- Electrically-isolated TO-220 package
- High voltage capability — up to 600 V
- High surge capability — up to 100 A
- Glass-passivated chip

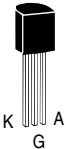
Compak Features

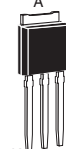

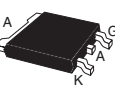
- Surface mount package — 0.8 A series
- New small-profile three-leaded Compak package
- Four gate sensitivities available
- Packaged in embossed carrier tape with 2,500 devices per reel
- Can replace SOT-223

TYPE	Part Number					I_T		V_{DRM} & V_{RRM}	I_{GT}	I_{DRM} & I_{RRM}			V_{TM}
	Non-isolated					(1)				(2) (12) (14) (18)	(20) (21)		
						Amps		Volts	μ Amps	μ Amps			Volts
	See "Package Dimensions" section for variations. (11)					$I_{T(RMS)}$	$I_{T(AV)}$	MIN	MAX	T_C or $T_L = 25^\circ C$	T_C or $T_L = 100^\circ C$	T_C or $T_L = 110^\circ C$	MAX
0.8 A				S2S1	0.8	0.51	200	12	2		100	1.7	
				S4S1	0.8	0.51	400	12	2		100	1.7	
				S6S1	0.8	0.51	600	12	2		100	1.7	
				S2S2	0.8	0.51	200	50	2		100	1.7	
				S4S2	0.8	0.51	400	50	2		100	1.7	
				S6S2	0.8	0.51	600	50	2		100	1.7	
				S2S	0.8	0.51	200	200	2		100	1.7	
				S4S	0.8	0.51	400	200	2		100	1.7	
				S6S	0.8	0.51	600	200	2		100	1.7	
				S2S3	0.8	0.51	200	500	2		100	1.7	
				S4S3	0.8	0.51	400	500	2		100	1.7	
				S6S3	0.8	0.51	600	500	2		100	1.7	
		EC103B			0.8	0.51	200	200	1	50		1.7	
		EC103D			0.8	0.51	400	200	1	50		1.7	
		EC103M			0.8	0.51	600	200	2	100		1.7	
		EC103B1			0.8	0.51	200	12	1	50		1.7	
		EC103D1			0.8	0.51	400	12	1	50		1.7	
		EC103M1			0.8	0.51	600	12	2	100		1.7	
		EC103B2			0.8	0.51	200	50	1	50		1.7	
		EC103D2			0.8	0.51	400	50	1	50		1.7	
	EC103M2			0.8	0.51	600	50	2	100		1.7		
	EC103B3			0.8	0.51	200	500	1	50		1.7		
	EC103D3			0.8	0.51	400	500	1	50		1.7		
	EC103M3			0.8	0.51	600	500	2	100		1.7		
	2N5064			0.8	0.51	200	200	1		50	1.7		
	2N6565			0.8	0.51	400	200	1		100	1.7		
1.5 A				TCR22-4	1.5	0.95	200	200	1		100	1.5	
				TCR22-6	1.5	0.95	400	200	1		100	1.5	
				TCR22-8	1.5	0.95	600	200	2		100	1.5	
4 A		T106B1			4	2.5	200	200	2		100	2.2	
		T106D1			4	2.5	400	200	2		100	2.2	
		T106M1			4	2.5	600	200	2		100	2.2	
		T107B1			4	2.5	200	500	2		100	2.5	
		T107D1			4	2.5	400	500	2		100	2.5	
		T107M1			4	2.5	600	500	2		100	2.5	
			S2004VS1	S2004DS1	4	2.5	200	50	2		100	1.6	
			S4004VS1	S4004DS1	4	2.5	400	50	2		100	1.6	
			S6004VS1	S6004DS1	4	2.5	600	50	2		100	1.6	
			S2004VS2	S2004DS2	4	2.5	200	200	2		100	1.6	
		S4004VS2	S4004DS2	4	2.5	400	200	2		100	1.6		
		S6004VS2	S6004DS2	4	2.5	600	200	2		100	1.6		

See "General Notes" on page E5 - 4 and "Electrical Specifications Notes" on page E5 - 5

V _{GT}			I _H	I _{GM}	V _{GRM}	P _{GM}	P _{G(AV)}	I _{TSM}	dv/dt		di/dt	t _{gt}	t _q	I ² t
(4) (12) (22)			(5) (15) (16) (19)	(17)		(17)		(6) (7) (13)				(8)	(9)	
Volts								Amps						
T _C or T _L = -40 °C	T _C or T _L = 25 °C	T _C or T _L = 110 °C	mAmps	Amps	Volts	Watts	Watts	60/50 Hz	Volts/μSec		Amps/μSec	μSec	μSec	Amps ² /Sec
MAX			MAX		MIN				MIN	TYP (23)		TYP	MAX	
1.2	0.8	0.2	5	1	5	1	0.1	20/16	20		50	2	60	1.6
1.2	0.8	0.2	5	1	5	1	0.1	20/16	20		50	2	60	1.6
1.2	0.8	0.2	5	1	5	1	0.1	20/16	10		50	2	60	1.6
1.2	0.8	0.25	5	1	5	1	0.1	20/16	25		50	3	60	1.6
1.2	0.8	0.25	5	1	5	1	0.1	20/16	25		50	3	60	1.6
1.2	0.8	0.25	5	1	5	1	0.1	20/16	10		50	3	60	1.6
1.2	0.8	0.25	5	1	5	1	0.1	20/16	30		50	4	50	1.6
1.2	0.8	0.25	5	1	5	1	0.1	20/16	30		50	4	50	1.6
1.2	0.8	0.25	5	1	5	1	0.1	20/16	15		50	4	50	1.6
1.2	0.8	0.25	8	1	5	1	0.1	20/16	40		50	5	45	1.6
1.2	0.8	0.25	8	1	5	1	0.1	20/16	40		50	5	45	1.6
1.2	0.8	0.25	8	1	5	1	0.1	20/16	20		50	5	45	1.6
1.2	0.8	0.25	5	1	5	1	0.1	20/16	30		50	3.5	50	1.6
1.2	0.8	0.25	5	1	5	1	0.1	20/16	30		50	3.5	50	1.6
1.2	0.8	0.25	5	1	5	1	0.1	20/16	15		50	3.5	50	1.6
1.2	0.8	0.2	5	1	5	1	0.1	20/16	20		50	2	60	1.6
1.2	0.8	0.2	5	1	5	1	0.1	20/16	20		50	2	60	1.6
1.2	0.8	0.2	5	1	5	1	0.1	20/16	10		50	2	60	1.6
1.2	0.8	0.25	5	1	5	1	0.1	20/16	25		50	3	60	1.6
1.2	0.8	0.25	5	1	5	1	0.1	20/16	25		50	3	60	1.6
1.2	0.8	0.25	5	1	5	1	0.1	20/16	10		50	3	60	1.6
1.2	0.8	0.25	8	1	5	1	0.1	20/16	40		50	5	45	1.6
1.2	0.8	0.25	8	1	5	1	0.1	20/16	40		50	5	45	1.6
1.2	0.8	0.25	8	1	5	1	0.1	20/16	20		50	5	45	1.6
1.2	0.8	0.25	5	1	5	1	0.1	20/16	25		50	2.2	60	1.6
1.2	0.8	0.25	5	1	6	1	0.1	20/16	25		50	2.2	60	1.6
1	0.8	0.25	5	1	6	1	0.1	20/16	60		50	3.5	50	1.6
1	0.8	0.25	5	1	6	1	0.1	20/16	40		50	3.5	50	1.6
1	0.8	0.25	5	1	6	1	0.1	20/16	30		50	3.5	50	1.6
1	0.8	0.2	5	1	6	1	0.1	20/16		8	50	4	50	1.6
1	0.8	0.2	5	1	6	1	0.1	20/16		8	50	4	50	1.6
1	0.8	0.2	5	1	6	1	0.1	20/16		8	50	4	50	1.6
1	0.8	0.2	6	1	6	1	0.1	20/16		8	50	5	45	1.6
1	0.8	0.2	6	1	6	1	0.1	20/16		8	50	5	45	1.6
1	0.8	0.2	6	1	6	1	0.1	20/16		8	50	5	45	1.6
1	0.8	0.2	4	1	6	1	0.1	30/25		8	50	3	50	3.7
1	0.8	0.2	4	1	6	1	0.1	30/25		8	50	3	50	3.7
1	0.8	0.2	4	1	6	1	0.1	30/25		8	50	3	50	3.7
1	0.8	0.2	6	1	6	1	0.1	30/25		8	50	4	50	3.7
1	0.8	0.2	6	1	6	1	0.1	30/25		8	50	4	50	3.7
1	0.8	0.2	6	1	6	1	0.1	30/25		8	50	4	50	3.7

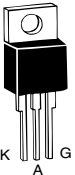
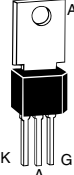
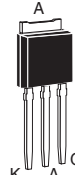
See "General Notes" on page E5 - 4 and "Electrical Specifications Notes" on page E5 - 5

TYPE	Part Number				I _T		V _{DRM} & V _{R_{RRM}}	I _{GT}	I _{DRM} & I _{R_{RRM}}		V _{TM}
	Isolated	Non-isolated							Amps		
	 TO-220	 TO-202	 TO-251 V-Pak	 TO-252 D-Pak	(1)	(1)	(2) (12)	(20) (21)	(3) (10)		
	See "Package Dimensions" section for variations. (11)				I _{T(RMS)} MAX	I _{T(AV)} MAX	Volts MIN	μAmps MAX	T _C = 25 °C MAX	T _C = 110 °C MAX	Volts MAX
6 A	S2006LS2	S2006FS21	S2006VS2	S2006DS2	6	3.8	200	200	5	250	1.6
	S4006LS2	S4006FS21	S4006VS2	S4006DS2	6	3.8	400	200	5	250	1.6
	S6006LS2	S6006FS21	S6006VS2	S6006DS2	6	3.8	600	200	5	250	1.6
	S2006LS3	S2006FS31	S2006VS3	S2006DS3	6	3.8	200	500	5	250	1.6
	S4006LS3	S4006FS31	S4006VS3	S4006DS3	6	3.8	400	500	5	250	1.6
	S6006LS3	S6006FS31	S6006VS3	S6006DS3	6	3.8	600	500	5	250	1.6
8 A	S2008LS2	S2008FS21	S2008VS2	S2008DS2	8	5.1	200	200	5	250	1.6
	S4008LS2	S4008FS21	S4008VS2	S4008DS2	8	5.1	400	200	5	250	1.6
	S6008LS2	S6008FS21	S6008VS2	S6008DS2	8	5.1	600	200	5	250	1.6
	S2008LS3	S2008FS31	S2008VS3	S2008DS3	8	5.1	200	500	5	250	1.6
	S4008LS3	S4008FS31	S4008VS3	S4008DS3	8	5.1	400	500	5	250	1.6
	S6008LS3	S6008FS31	S6008VS3	S6008DS3	8	5.1	600	500	5	250	1.6
10 A	S2010LS2	S2010FS21	S2010VS2	S2010DS2	10	6.4	200	200	5	250	1.6
	S4010LS2	S4010FS21	S4010VS2	S4010DS2	10	6.4	400	200	5	250	1.6
	S6010LS2	S6010FS21	S6010VS2	S6010DS2	10	6.4	600	200	5	250	1.6
	S2010LS3	S2010FS31	S2010VS3	S2010DS3	10	6.4	200	500	5	250	1.6
	S4010LS3	S4010FS31	S4010VS3	S4010DS3	10	6.4	400	500	5	250	1.6
	S6010LS3	S6010FS31	S6010VS3	S6010DS3	10	6.4	600	500	5	250	1.6

Specific Test Conditions

- di/dt** — Maximum rate-of-change of on-state current; I_{GT} = 50 mA pulse width ≥15 μsec with ≤0.1 μs rise time
- dv/dt** — Critical rate-of-rise of forward off-state voltage
- I²t** — RMS surge (non-repetitive) on-state current for period of 8.3 ms for fusing
- I_{DRM} and I_{R_{RRM}}** — Peak off-state current at V_{DRM} and V_{R_{RRM}}
- I_{GT}** — DC gate trigger current V_D = 6 V dc; R_L = 100 Ω
- I_{GM}** — Peak gate current
- I_H** — DC holding current; initial on-state current = 20 mA
- I_T** — Maximum on-state current
- I_{TSM}** — Peak one-cycle forward surge current
- P_{G(AV)}** — Average gate power dissipation
- P_{GM}** — Peak gate power dissipation
- t_{gt}** — Gate controlled turn-on time gate pulse = 10 mA; minimum width = 15 μS with rise time ≤0.1 μs
- t_q** — Circuit commutated turn-off time
- V_{DRM} and V_{R_{RRM}}** — Repetitive peak off-state forward and reverse voltage
- V_{G_{RM}}** — Peak reverse gate voltage
- V_{GT}** — DC gate trigger voltage; V_D = 6 V dc; R_L = 100 Ω
- V_{TM}** — Peak on-state voltage





General Notes

- Teccor 2N5064 and 2N6565 Series devices conform to all JEDEC registered data. See specifications table on pages E5 - 2 and E5 - 3.
- The case lead temperature (T_C or T_L) is measured as shown on dimensional outline drawings in the "Package Dimensions" section of this catalog.
- All measurements (except I_{GT}) are made with an external resistor R_{GK} = 1 kΩ unless otherwise noted.
- All measurements are made at 60 Hz with a resistive load at an ambient temperature of +25 °C unless otherwise specified.
- Operating temperature (T_J) is -65 °C to +110 °C for EC Series devices, -65 °C to +125 °C for 2N Series devices, -40 °C to +125 °C for "TCR" Series, and -40 °C to +110 °C for all others.
- Storage temperature range (T_S) is -65 °C to +150 °C for TO-92 devices, -40 °C to +150 °C for TO-202 and Compak devices, and -40 °C to +125 °C for all others.
- Lead solder temperature is a maximum of +230 °C for 10 seconds maximum ≥1/16" (1.59 mm) from case.

V _{GT}			I _H	I _{GM}	V _{GRM}	P _{GM}	P _{G(AV)}	I _{TSM}	dv/dt	di/dt	t _{gt}	t _q	I ² t
(4) (12) (22)			(5) (19)	(17)		(17)		(6) (13)			(8)	(9)	
Volts									Volts/μSec				
T _C = -40 °C	T _C = 25 °C	T _C = 110 °C	mAmps	Amps	Volts	Watts	Watts	Amps	T _C = 110 °C	Amps/μSec	μSec	μSec	Amps ² Sec
MAX			MAX		MIN			60/50 Hz	TYP		TYP	MAX	
1	0.8	0.25	6	1	6	1	0.1	100/83	10	100	4	50	41
1	0.8	0.25	6	1	6	1	0.1	100/83	8	100	4	50	41
1	0.8	0.25	6	1	6	1	0.1	100/83	8	100	4	50	41
1	0.8	0.25	8	1	6	1	0.1	100/83	10	100	5	45	41
1	0.8	0.25	8	1	6	1	0.1	100/83	8	100	5	45	41
1	0.8	0.25	8	1	6	1	0.1	100/83	8	100	5	45	41
1	0.8	0.25	6	1	6	1	0.1	100/83	10	100	4	50	41
1	0.8	0.25	6	1	6	1	0.1	100/83	8	100	4	50	41
1	0.8	0.25	6	1	6	1	0.1	100/83	8	100	4	50	41
1	0.8	0.25	8	1	6	1	0.1	100/83	10	100	5	45	41
1	0.8	0.25	8	1	6	1	0.1	100/83	8	100	5	45	41
1	0.8	0.25	8	1	6	1	0.1	100/83	8	100	5	45	41
1	0.8	0.25	6	1	6	1	0.1	100/83	10	100	4	50	41
1	0.8	0.25	6	1	6	1	0.1	100/83	8	100	4	50	41
1	0.8	0.25	6	1	6	1	0.1	100/83	8	100	4	50	41
1	0.8	0.25	8	1	6	1	0.1	100/83	10	100	5	45	41
1	0.8	0.25	8	1	6	1	0.1	100/83	8	100	5	45	41
1	0.8	0.25	8	1	6	1	0.1	100/83	8	100	5	45	41

Electrical Specifications Notes

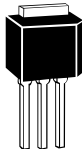
- (1) See Figure E5.1 through Figure E5.9 for current ratings at specified operating temperatures.
- (2) See Figure E5.10 for I_{GT} versus T_C or T_L.
- (3) See Figure E5.11 for instantaneous on-state current (I_T) versus on-state voltage (V_T) TYP.
- (4) See Figure E5.12 for V_{GT} versus T_C or T_L.
- (5) See Figure E5.13 for I_H versus T_C or T_L.
- (6) For more than one full cycle, see Figure E5.14.
- (7) 0.8 A to 4 A devices also have a pulse peak forward current on-state rating (repetitive) of 75 A. This rating applies for operation at 60 Hz, 75 °C maximum tab (or anode) lead temperature, switching from 80 V peak, sinusoidal current pulse width of 10 μs minimum, 15 μs maximum. See Figure E5.20 and Figure E5.21.
- (8) See Figure E5.15 for t_{gt} versus I_{GT}.
- (9) Test conditions as follows:
 - T_C or T_L ≤ 80 °C, rectangular current waveform
 - Rate-of-rise of current ≤ 10 A/μs
 - Rate-of-reversal of current ≤ 5 A/μs
 - I_{TM} = 1 A (50 μs pulse), Repetition Rate = 60 pps
 - V_{RRM} = Rated
 - V_R = 15 V minimum, V_{DRM} = Rated
 - Rate-of-rise reapplied forward blocking voltage = 5 V/μs
 - Gate Bias = 0 V, 100 Ω (during turn-off time interval)
- (10) Test condition is maximum rated RMS current except TO-92 devices are 1.2 A_{PK}; T106/T107 devices are 4 A_{PK}.
- (11) See package outlines for lead form configurations. When ordering special lead forming, add type number as suffix to part number.
- (12) V_D = 6 V dc, R_L = 100 Ω (See Figure E5.19 for simple test circuit for measuring gate trigger voltage and gate trigger current.)
- (13) See Figure E5.1 through Figure E5.9 for maximum allowable case temperature at maximum rated current.
- (14) I_{GT} = 500 μA maximum at T_C = -40 °C for T106 devices
- (15) I_H = 10 mA maximum at T_C = -65 °C for 2N5064 Series and 2N6565 Series devices
- (16) I_H = 6 mA maximum at T_C = -40 °C for T106 devices
- (17) Pulse Width ≤ 10 μs
- (18) I_{GT} = 350 μA maximum at T_C = -65 °C for 2N5064 Series and 2N6565 Series devices
- (19) Latching current can be higher than 20 mA for higher I_{GT} types. Also, latching current can be much higher at -40 °C. See Figure E5.18.
- (20) T_C or T_L = T_J for test conditions in off state
- (21) I_{DRM} and I_{RRM} = 50 μA for 2N5064 and 100 μA for 2N6565 at 125 °C
- (22) TO-92 devices specified at -65 °C instead of -40 °C
- (23) T_C = 110 °C

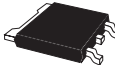
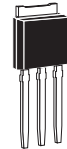
Thermal Resistance (Steady State) $R_{\theta JC}$ [$R_{\theta JA}$] °C/W (TYPICAL)							
Package Code	E	L	F2	F	C	D	V
Type	 TO-92	 TO-220	 TO-202 Type 2, 4, & 41	 TO-202 Type 1 & 3	 Compak	 TO-252 D-Pak	 TO-251 V-Pak
0.8 A	75 [160]				60*		
1.5 A	50 [160]						
4.0 A			10 [100]	6.2 [80]		3.0	3.8 [85]
6.0 A		4.0 [65]		4.3		1.8	2.4
8.0 A		3.4		3.9		1.5	2.1
10.0 A		3.0		3.4		1.45	1.72

*Mounted on 1 cm² copper foil surface; two-ounce copper foil

Electrical Isolation

Teccor's isolated sensitive SCRs will withstand a minimum high potential test of 2500 V ac rms from leads to mounting tab over the device's operating temperature range. The following table shows other standard and optional isolation ratings.

Electrical Isolation * from Leads to Mounting Tab	
V AC RMS	TO-220
2500	Standard
4000	Optional **

*UL Recognized File #E71639

**For 4000 V isolation, use "V" suffix in part number.

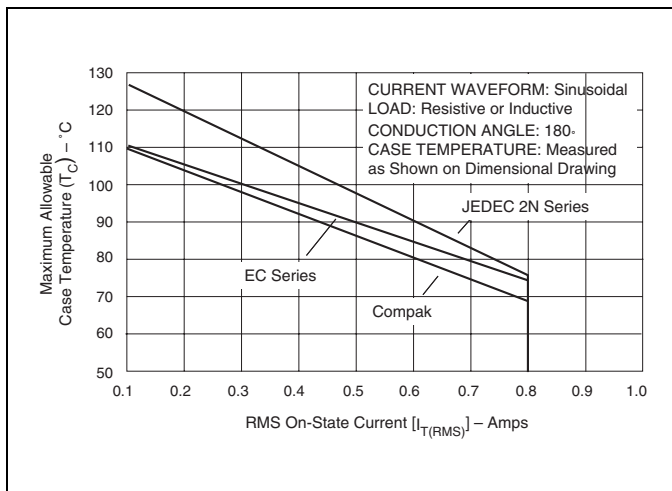

Figure E5.1 Maximum Allowable Case Temperature versus RMS On-state Current

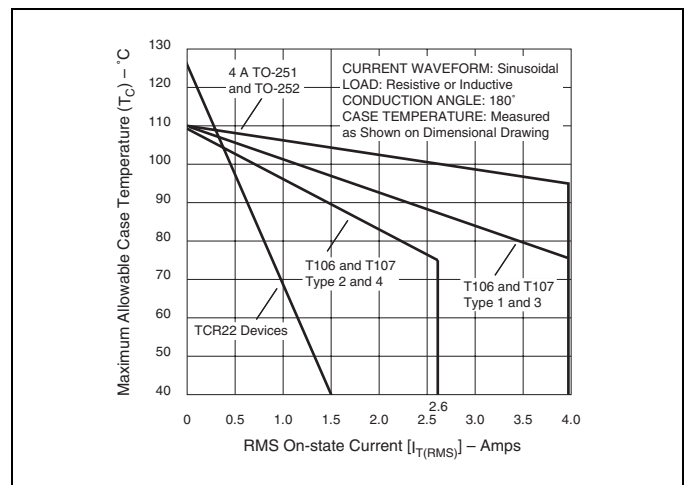

Figure E5.2 Maximum Allowable Case Temperature versus RMS On-state Current

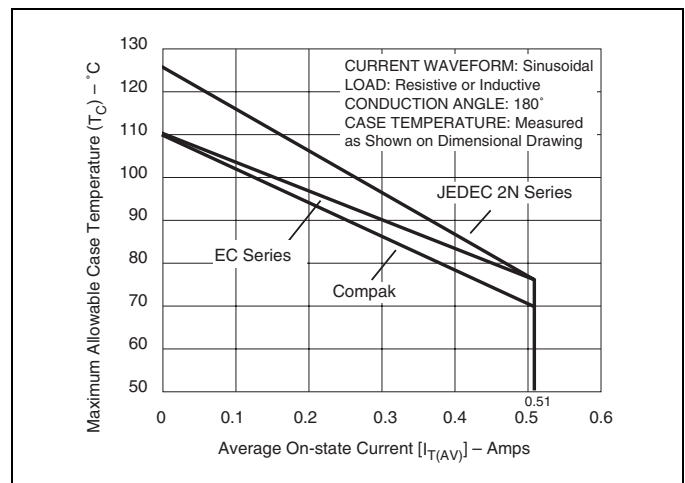

Figure E5.3 Maximum Allowable Case Temperature versus Average On-state Current

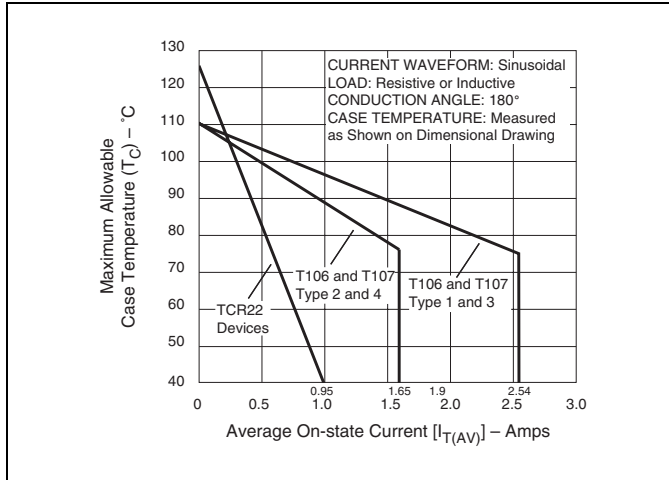

Figure E5.4 Maximum Allowable Case Temperature versus Average On-state Current

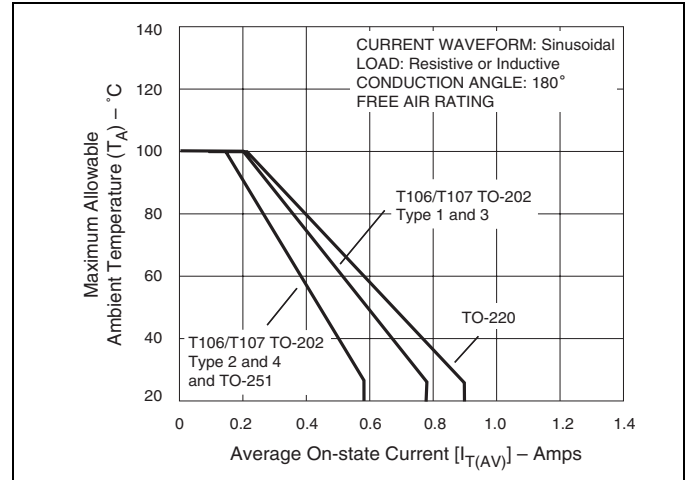

Figure E5.7 Maximum Allowable Ambient Temperature versus Average On-state Current

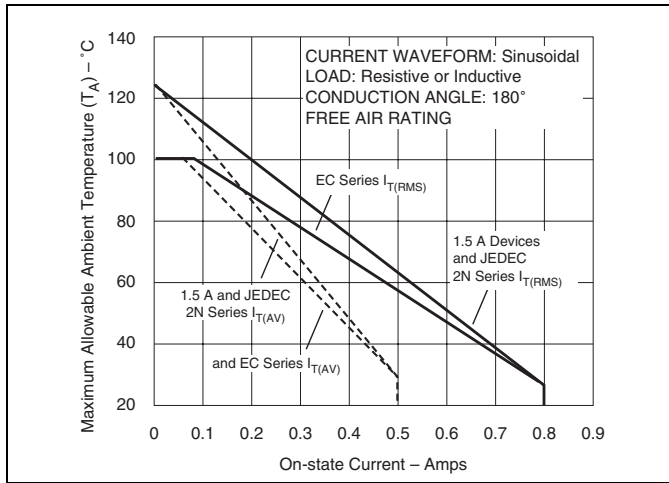

Figure E5.5 Maximum Allowable Ambient Temperature versus On-state Current

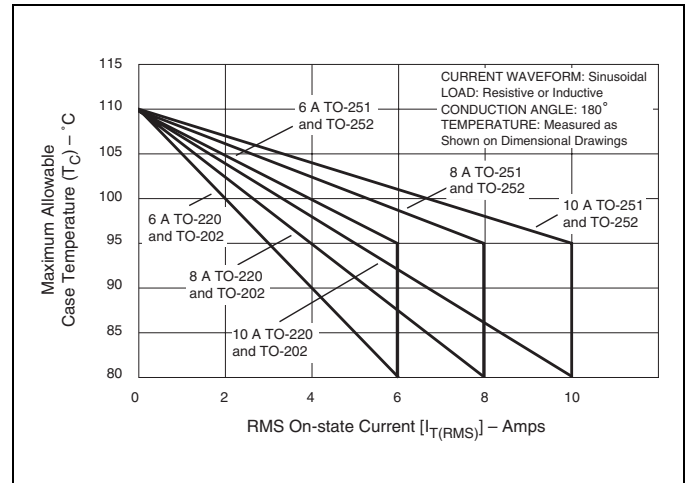

Figure E5.8 Maximum Allowable Case Temperature versus RMS On-state Current

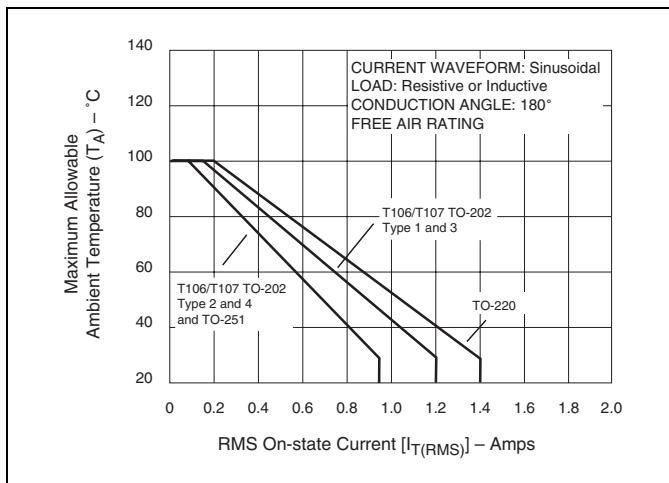

Figure E5.6 Maximum Allowable Ambient Temperature versus RMS On-state Current

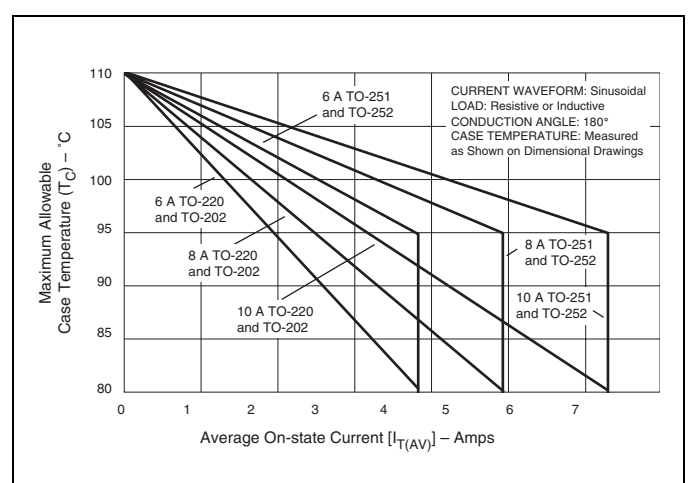

Figure E5.9 Maximum Allowable Case Temperature versus Average On-state Current

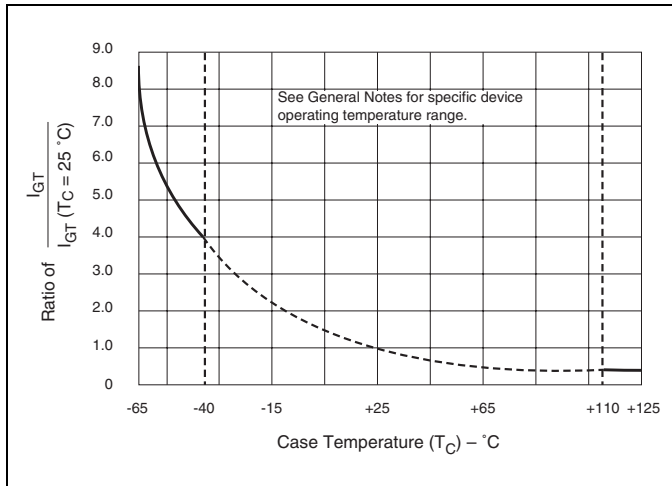

Figure E5.10 Normalized DC Gate-Trigger Current versus Case Temperature

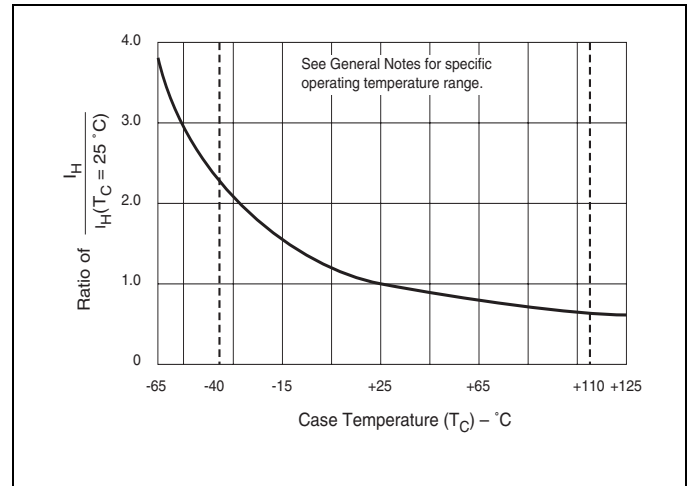

Figure E5.13 Normalized DC Holding Current versus Case Temperature

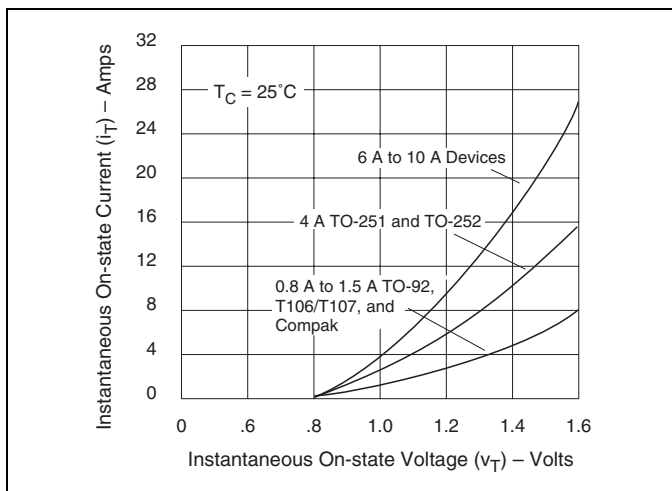

Figure E5.11 Instantaneous On-state Current versus On-state Voltage (Typical)

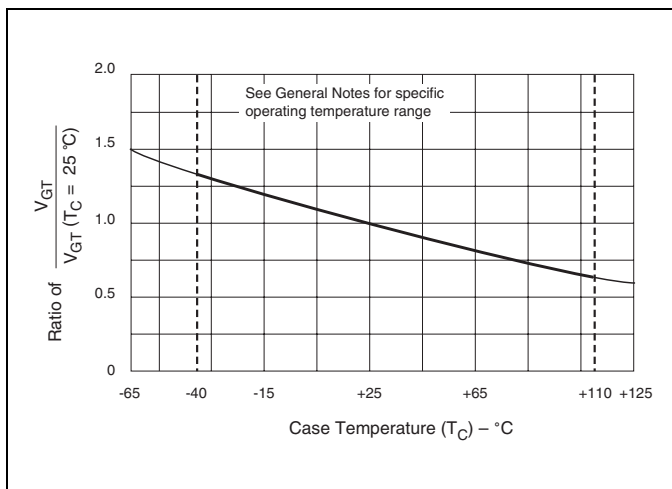

Figure E5.12 Normalized DC Gate-Trigger Voltage versus Case Temperature

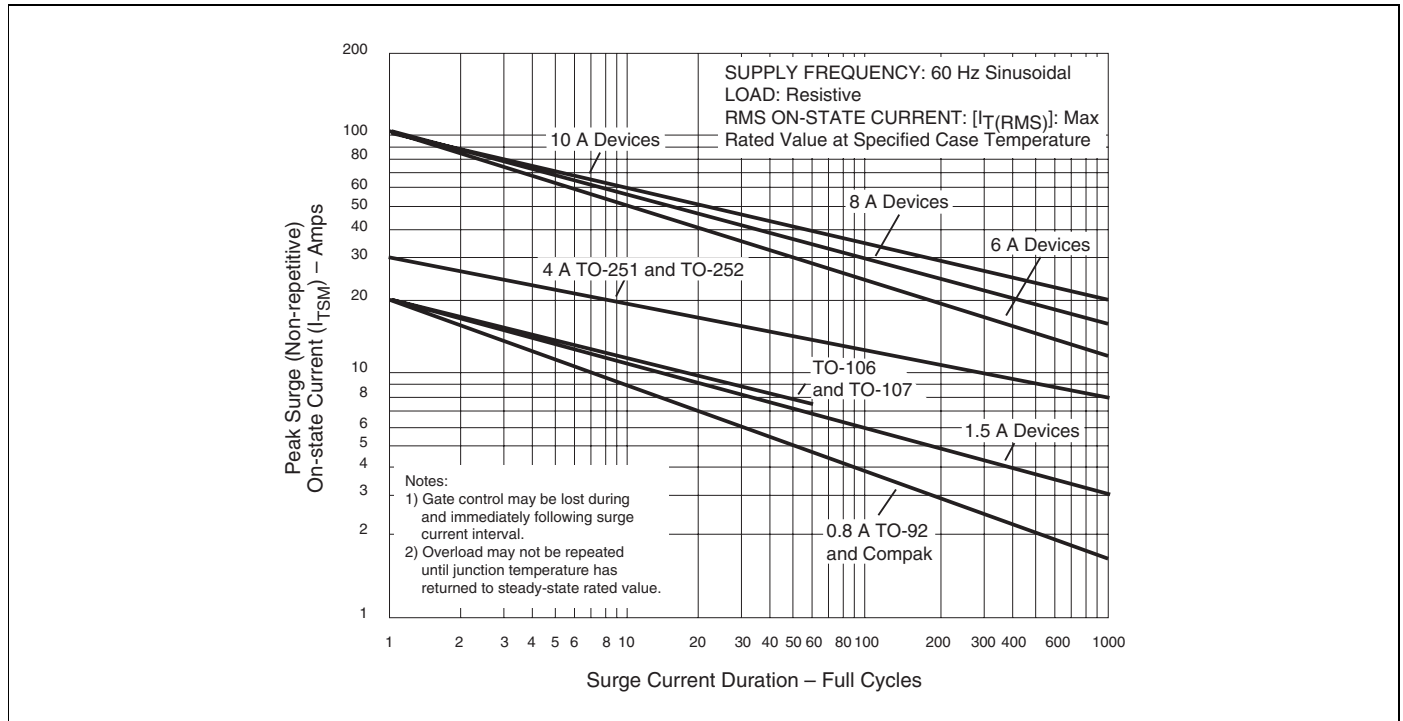

Figure E5.14 Peak Surge On-state Current versus Surge Current Duration

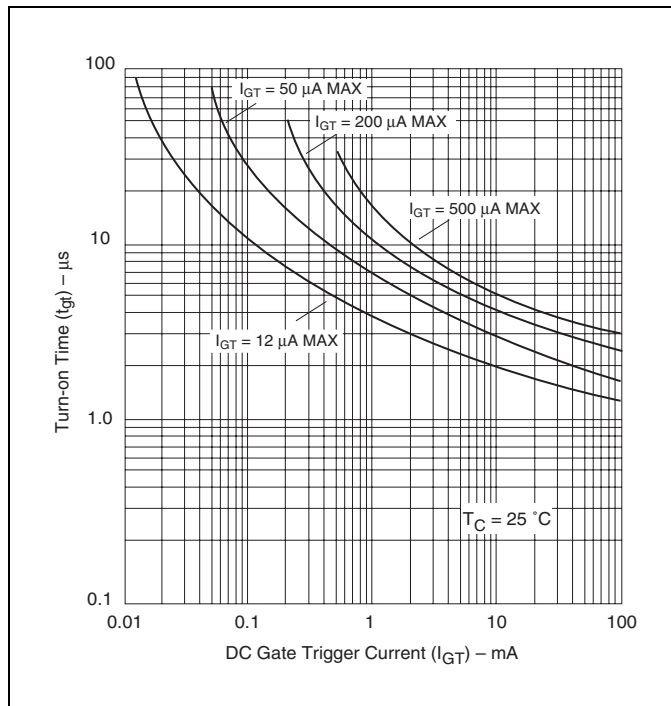

Figure E5.15 Typical Turn-on Time versus Gate Trigger Current

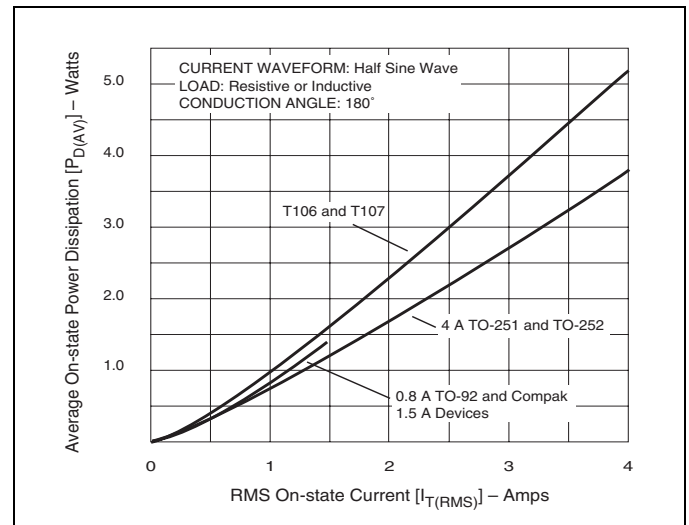

Figure E5.16 Power Dissipation (Typical) versus RMS On-state Current

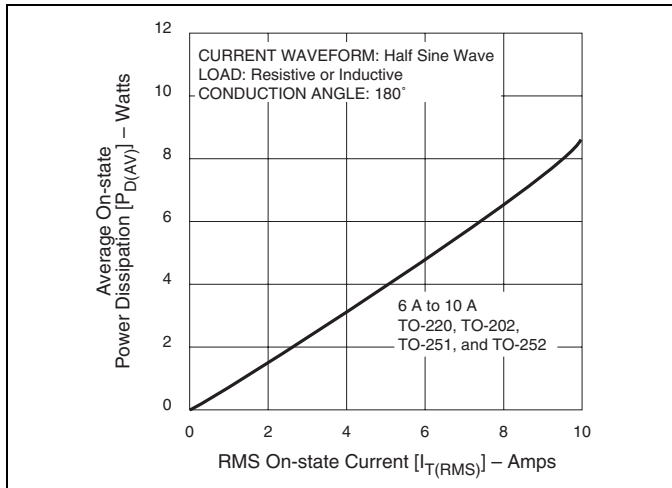

Figure E5.17 Power Dissipation (Typical) versus RMS On-state Current

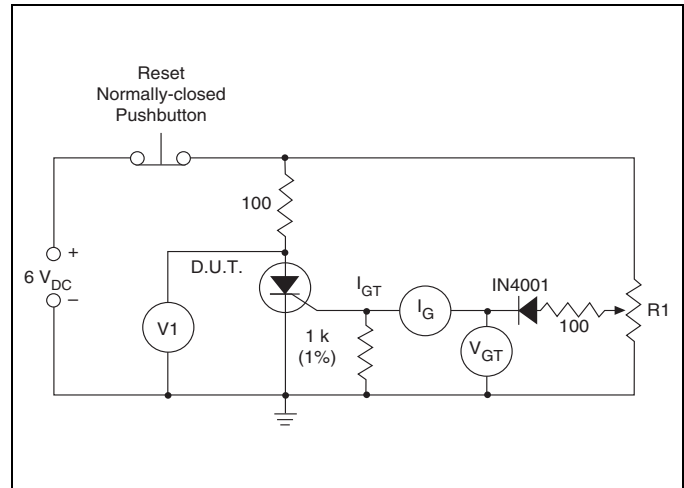

Figure E5.19 Simple Test Circuit for Gate Trigger Voltage and Current Measurement

- Note: V1 — 0 V to 10 V dc meter
 V_{GT} — 0 V to 1 V dc meter
 I_G — 0 mA to 1 mA dc milliammeter
 R1 — 1 k potentiometer

To measure gate trigger voltage and current, raise gate voltage (V_{GT}) until meter reading V1 drops from 6 V to 1 V. Gate trigger voltage is the reading on V_{GT} just prior to V1 dropping. Gate trigger current I_{GT} can be computed from the relationship

$$I_{GT} = I_G - \frac{V_{GT}}{1000} \text{ Amps}$$

where I_G is reading (in amperes) on meter just prior to V1 dropping.

Note: I_{GT} may turn out to be a negative quantity (trigger current flows out from gate lead).

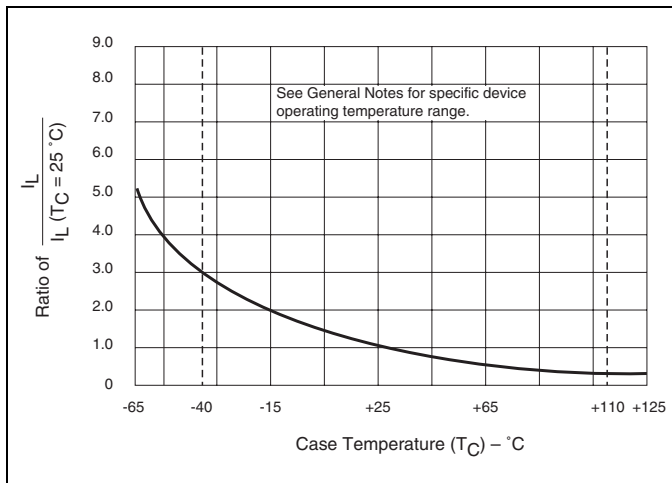

Figure E5.18 Normalized DC Latching Current versus Case Temperature

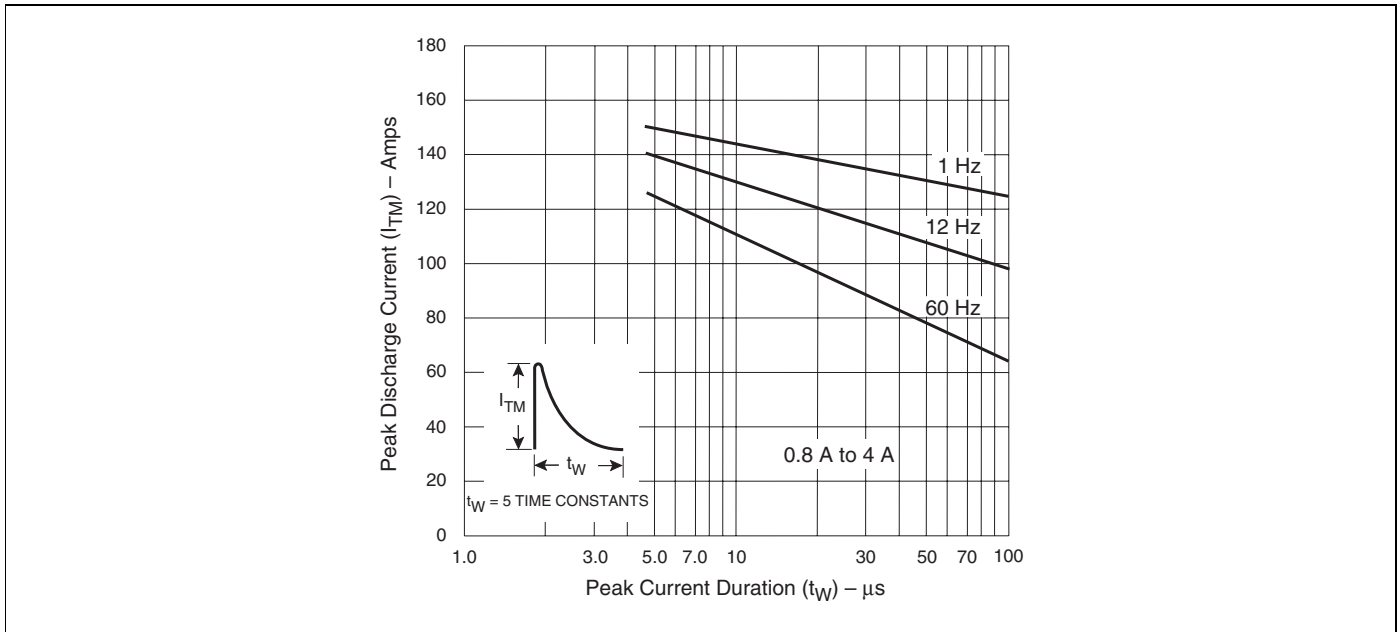

Figure E5.20 Peak Repetitive Capacitor Discharge Current

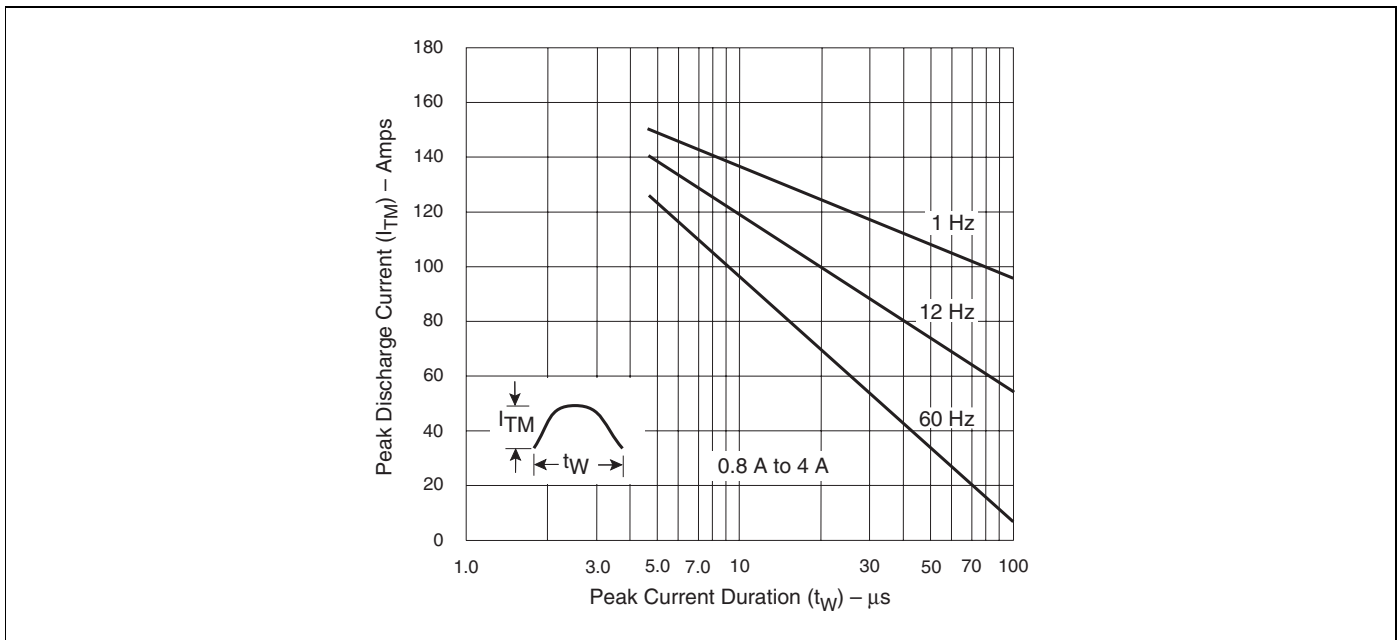
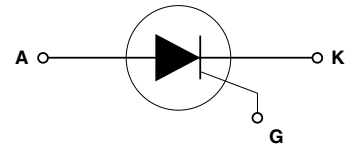
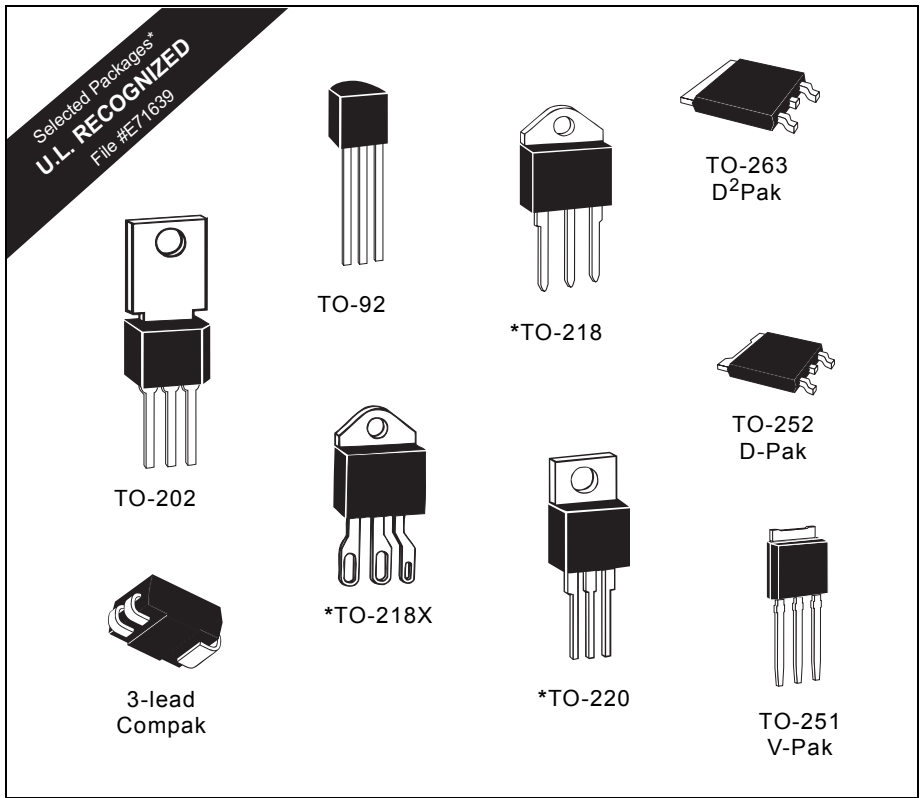

Figure E5.21 Peak Repetitive Sinusoidal Curve



SCRs

(1 A to 70 A)

General Description

The Teccor line of thyristor SCR semi-conductors are half-wave, unidirectional, gate-controlled rectifiers which complement Teccor's line of sensitive SCRs. Teccor offers devices with ratings of 1 A to 70 A and 200 V to 1000 V, with gate sensitivities from 10 mA to 50 mA. If gate currents in the 12 μ A to 500 μ A ranges are required, see "Sensitive SCRs" section of this catalog.

Three packages are offered in electrically isolated construction where the case or tab is internally isolated to allow the use of low-cost assembly and convenient packaging techniques.

The Teccor line of SCRs features glass-passivated junctions to ensure long-term reliability and parameter stability. Teccor's glass offers a rugged, reliable barrier against junction contamination.



Variations of devices covered in this data sheet are available for custom design applications. Consult the factory for more information.

Features

- Electrically-isolated package
- High voltage capability — 200 V to 1000 V
- High surge capability — up to 950 A
- Glass-passivated chip

Compak SCR

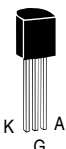
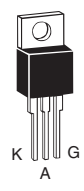
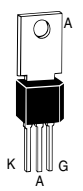
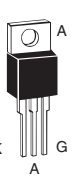
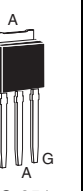
- Surface mount package — 1 A series
- New small profile three-leaded Compak package
- Packaged in embossed carrier tape with 2,500 devices per reel
- Can replace SOT-223

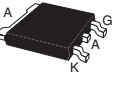
TYPE	Part Number						I_T		V_{DRM} & V_{RRM}		I_{GT}	
	 TO-92	Isolated		Non-isolated			Amps		Volts	mAmps		
		 TO-220	 TO-202	 TO-220	 TO-251 V-Pak	 Compak	 TO-252 D-Pak	(1)		(2) (15)	MIN	MIN
See "Package Dimensions" section for variations. (11)							$I_{T(RMS)}$ MAX	$I_{T(AV)}$ MAX				
1 A	S201E					S2N1	1	0.64	200	1	10	
	S401E					S4N1	1	0.64	400	1	10	
	S601E					S6N1	1	0.64	600	1	10	
6 A	S2006L	S2006F1			S2006V		S2006D	6	3.8	200	1	15
	S4006L	S4006F1			S4006V		S4006D	6	3.8	400	1	15
	S6006L	S6006F1			S6006V		S6006D	6	3.8	600	1	15
	S8006L				S8006V		S8006D	6	3.8	800	1	15
8 A	SK006L				SK006V		SK006D	6	3.8	1000	1	15
	S2008L	S2008F1	S2008R	S2008V		S2008D	8	5.1	200	1	15	
	S4008L	S4008F1	S4008R	S4008V		S4008D	8	5.1	400	1	15	
	S6008L	S6008F1	S6008R	S6008V		S6008D	8	5.1	600	1	15	
10 A	S8008L		S8008R	S8008V		S8008D	8	5.1	800	1	15	
	SK008L		SK008R	SK008V		SK008D	8	5.1	1000	1	15	
	S2010L	S2010F1	S2010R	S2010V		S2010D	10	6.4	200	1	15	
	S4010L	S4010F1	S4010R	S4010V		S4010D	10	6.4	400	1	15	
12 A	S6010L	S6010F1	S6010R	S6010V		S6010D	10	6.4	600	1	15	
	S8010L		S8010R	S8010V		S8010D	10	6.4	800	1	15	
	SK010L		SK010R	SK010V		SK010D	10	6.4	1000	1	15	
12 A			S2012R	S2012V		S2012D	12	7.6	200	1	20	
			S4012R	S4012V		S4012D	12	7.6	400	1	20	
			S6012R	S6012V		S6012D	12	7.6	600	1	20	
			S8012R	S8012V		S8012D	12	7.6	800	1	20	
			SK012R	SK012V		SK012D	12	7.6	1000	1	20	

Specific Test Conditions

- di/dt — Maximum rate-of-rise of on-state current; $I_{GT} = 150$ mA with ≤ 0.1 μ s rise time
- dv/dt — Critical rate of applied forward voltage
- I^2t — RMS surge (non-repetitive) on-state current for period of 8.3 ms for fusing
- I_{DRM} and I_{RRM} — Peak off-state forward and reverse current at V_{DRM} and V_{RRM}
- I_{gt} — dc gate trigger current; $V_D = 12$ V dc; $R_L = 60$ Ω for 1 to 16 A devices and 30 Ω for 20 to 70 A devices
- I_{GM} — Peak gate current
- I_H — dc holding current; gate open
- I_T — Maximum on-state current
- I_{TSM} — Peak one-cycle forward surge current
- $P_{G(AV)}$ — Average gate power dissipation
- P_{GM} — Peak gate power dissipation
- t_{gt} — Gate controlled turn-on time; gate pulse = 100 mA; minimum width = 15 μ s with rise time ≤ 0.1 μ s
- t_q — Circuit commutated turn-off time

- V_{DRM} and V_{RRM} — Repetitive peak off-state forward and reverse voltage
- V_{gt} — DC gate trigger voltage; $V_D = 12$ V dc; $R_L = 60$ Ω for 1 to 16 A devices and 30 Ω for 20 to 70 A devices
- V_{TM} — Peak on-state voltage at maximum rated RMS current





General Notes

- All measurements are made at 60 Hz with a resistive load at an ambient temperature of +25 °C unless otherwise specified.
- Operating temperature range (T_J) is -65 °C to +125 °C for TO-92 devices and -40 °C to +125 °C for all other packages.
- Storage temperature range (T_S) is -65 °C to +150 °C for TO-92 devices, -40 °C to +150 °C for TO-202 and TO-220 devices, and -40 °C to +125 °C for all others.
- Lead solder temperature is a maximum of 230 °C for 10 seconds maximum; $\geq 1/16"$ (1.59 mm) from case.
- The case temperature (T_C) is measured as shown on dimensional outline drawings in the "Package Dimensions" section of this catalog.

I _{DRM} & I _{RRM}			V _{TM}	V _{GT}	I _H	I _{GM}	P _{GM}	P _{G(AV)}	I _{TSM}	dv/dt		I ² t	di/dt	t _{gt}	t _q	
(14)			(3)	(8) (17)	(5) (13)	(12)	(12)		(6) (10)						(7)	(9) (10)
mAmps			Volts	Volts					Amps	Volts/μSec						
T _C = 25 °C	T _C = 100 °C	T _C = 125 °C	T _C = 25 °C	T _C = 25 °C	mAmps	Amps	Watts	Watts	60/50 Hz	T _C = 100 °C	T _C = 125 °C	Amps ² Sec	Amps/μSec	μSec	μSec	
MAX			MAX	MAX	MAX					MIN	MIN			TYP	MAX	
0.01	0.2	0.5	1.6	1.5	30	1.5	15	0.3	30/25	40	20	3.7	50	2	35	
0.01	0.2	0.5	1.6	1.5	30	1.5	15	0.3	30/25	40	20	3.7	50	2	35	
0.01	0.2	0.5	1.6	1.5	30	1.5	15	0.3	30/25	40	20	3.7	50	2	35	
0.01	0.2	0.5	1.6	1.5	30	2	20	0.5	100/83	350	250	41	100	2	35	
0.01	0.2	0.5	1.6	1.5	30	2	20	0.5	100/83	350	250	41	100	2	35	
0.01	0.2	0.5	1.6	1.5	30	2	20	0.5	100/83	300	225	41	100	2	35	
0.01	0.2	0.5	1.6	1.5	30	2	20	0.5	100/83	250	200	41	100	2	35	
0.02	3		1.6	1.5	30	2	20	0.5	100/83	100		41	100	2	35	
0.01	0.2	0.5	1.6	1.5	30	2	20	0.5	100/83	350	250	41	100	2	35	
0.01	0.2	0.5	1.6	1.5	30	2	20	0.5	100/83	350	250	41	100	2	35	
0.01	0.2	0.5	1.6	1.5	30	2	20	0.5	100/83	300	225	41	100	2	35	
0.01	0.2	0.5	1.6	1.5	30	2	20	0.5	100/83	250	200	41	100	2	35	
0.02	3		1.6	1.5	30	2	20	0.5	100/83	100		41	100	2	35	
0.01	0.2	0.5	1.6	1.5	30	2	20	0.5	100/83	350	250	41	100	2	35	
0.01	0.2	0.5	1.6	1.5	30	2	20	0.5	100/83	350	250	41	100	2	35	
0.01	0.2	0.5	1.6	1.5	30	2	20	0.5	100/83	300	225	41	100	2	35	
0.02	0.5	1	1.6	1.5	30	2	20	0.5	100/83	250	200	41	100	2	35	
0.02	3		1.6	1.5	30	2	20	0.5	100/83	100		41	100	2	35	
0.01	0.5	1	1.6	1.5	40	2	20	0.5	120/100	350	250	60	100	2	35	
0.01	0.5	1	1.6	1.5	40	2	20	0.5	120/100	350	250	60	100	2	35	
0.01	0.5	1	1.6	1.5	40	2	20	0.5	120/100	300	225	60	100	2	35	
0.02	0.5	1	1.6	1.5	40	2	20	0.5	120/100	250	200	60	100	2	35	
0.02	3		1.6	1.5	40	2	20	0.5	120/100	100		60	100	2	35	

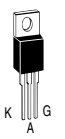
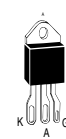
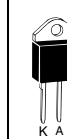
Electrical Specification Notes

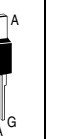

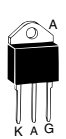





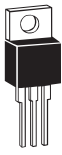

- See Figure E6.5 through Figure E6.16 for current rating at specified operating case temperature.
- See Figure E6.1 and Figure E6.2 for free air current rating.
- See Figure E6.19 and Figure E6.20 for instantaneous on-state current versus on-state voltage (typical).
- See Figure E6.18 for I_{GT} versus T_C.
- See Figure E6.17 for I_H versus T_C.
- For more than one full cycle rating, see Figure E6.23.
- See Figure E6.22 for t_{gt} versus I_{GT}.
- See Figure E6.21 for V_{GT} versus T_C.
- Test conditions are as follows:
 - I_T = 1 A for 1 A devices and 2 A for all other devices
 - Pulse duration = 50 μs, dv/dt = 20 V/μs, di/dt = -10 A/μs for 1 A devices, and -30 A/μs for other devices
 - I_{GT} = 200 mA at turn-on
- See Figure E6.5 through Figure E6.10 for maximum allowable case temperatures at maximum rated current.
- See package outlines for lead form configuration. When ordering special lead forming, add type number as suffix to part number.
- Pulse width ≤ 10 μs
- Initial on-state current = 200 mA dc for 1 A through 16 A devices; 400 mA dc for 20 A through 70 A devices.
- T_C = T_J for test conditions in off state.
- The R, K, or M package rating is intended for high surge condition use only and not recommended for ≥ 50 A rms continuous current use since narrow pin lead temperature can exceed PCB solder melting temperature. Teccor's J package or W package is recommended for ≥ 50 A rms continuous current requirements.
- For various durations of an exponentially decaying current waveform, see Figure E6.3 and Figure E6.4. (t_W is defined as 5 time constants.)
- Minimum non-trigger V_{GT} at 125 °C is 0.2 V.

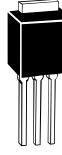

TYPE	Part Number						I _T		V _{DRM} & V _{RRM}	I _{GT}		I _{DRM} & I _{RRM}			
	Isolated			Non-isolated			(1) (15)		Volts	(4)		(14)			
								Amps		mAmps	mAmps	mAmps			
	TO-220	TO-218X	TO-218	TO-220	TO-218X	TO-218	TO-263 D ² Pak	I _{T(RMS)}	I _{T(AV)}			T _C = 25 °C	T _C = 100 °C	T _C = 125 °C	
See "Package Dimensions" section for variations. (11)							MAX		MIN	MIN	MAX	MAX			
15 A	S2015L						15	9.5	200	1	30	0.01	0.5	1	
	S4015L						15	9.5	400	1	30	0.01	0.5	1	
	S6015L						15	9.5	600	1	30	0.01	0.5	1	
	S8015L						15	9.5	800	1	30	0.02	1	2	
	SK015L						15	9.5	1000	1	30	0.02	3		
16 A				S2016R		S2016N	16	10	200	1	30	0.01	0.5	1	
				S4016R		S4016N	16	10	400	1	30	0.01	0.5	1	
				S6016R		S6016N	16	10	600	1	30	0.01	0.5	1	
				S8016R		S8016N	16	10	800	1	30	0.02	1	2	
				SK016R		SK016N	16	10	1000	1	30	0.02	3		
20 A	S2020L						20	12.8	200	1	30	0.01	0.5	1	
	S4020L						20	12.8	400	1	30	0.01	0.5	1	
	S6020L						20	12.8	600	1	30	0.01	0.5	1	
	S8020L						20	12.8	800	1	30	0.02	1.0	2	
	SK020L						20	12.8	1000	1	30	0.02	3		
25 A	S2025L			S2025R		S2025N	25	16	200	1	35	0.01	1	2	
	S4025L			S4025R		S4025N	25	16	400	1	35	0.01	1	2	
	S6025L			S6025R		S6025N	25	16	600	1	35	0.01	1	2	
	S8025L			S8025R		S8025N	25	16	800	1	35	0.02	1.5	3	
	SK025L			SK025R		SK025N	25	16	1000	1	35	0.02	3		
35 A		S2035J	S2035K				35	22	200	5	40	0.01	1	2	
		S4035J	S4035K				35	22	400	5	40	0.01	1	2	
		S6035J	S6035K				35	22	600	5	40	0.01	1	2	
		S8035J	S8035K				35	22	800	5	40	0.02	1.5	3	
			SK035K				35	22	1000	5	40	0.02	3		
40 A				S2040R		S2040N	40	25	200	5	40	0.01	1	2	
				S4040R		S4040N	40	25	400	5	40	0.01	1	2	
				S6040R		S6040N	40	25	600	5	40	0.01	1	2	
				S8040R		S8040N	40	25	800	5	40	0.02	1.5	3	
				SK040R		SK040N	40	25	1000	5	40	0.03	5		
55 A				S2055R	S2055W	S2055M	S2055N	55	35	200	5	40	0.01	1	2
				S4055R	S4055W	S4055M	S4055N	55	35	400	5	40	0.01	1	2
				S6055R	S6055W	S6055M	S6055N	55	35	600	5	40	0.01	1	2
				S8055R	S8055W	S8055M	S8055N	55	35	800	5	40	0.02	1.5	3
				SK055R		SK055M	SK055N	55	35	1000	5	40	0.03	5	
65 A		S2065J	S2065K				65	41	200	5	50	0.02	1.5	3	
		S4065J	S4065K				65	41	400	5	50	0.02	1.5	3	
		S6065J	S6065K				65	41	600	5	50	0.02	1.5	3	
		S8065J	S8065K				65	41	800	5	50	0.02	2	5	
			SK065K				65	41	1000	5	50	0.03	5		
70 A				S2070W			70	45	200	5	50	0.02	1.5	3	
				S4070W			70	45	400	5	50	0.02	1.5	3	
				S6070W			70	45	600	5	50	0.02	1.5	3	
				S8070W			70	45	800	5	50	0.02	2	5	

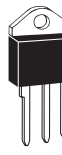
See "General Notes" on page E6 - 2 and "Electrical Specification Notes" on page E6 - 3.

V _{TM}	V _{GT}	I _H	I _{GM}	P _{GM}	P _{G(AV)}	I _{TSM}	dv/dt		I ² t	di/dt	t _{gt}	t _q
(3)	(8) (17)	(5) (13)	(12)	(12)		(6) (10) (16)					(7)	(9) (10)
Volts	Volts	mAmps	Amps	Watts	Watts	Amps	Volts/μSec		Amps ² Sec	Amps/μSec	μSec	μSec
T _C = 25 °C	T _C = 25 °C					60/50 Hz	T _C = 100 °C	T _C = 125 °C				
MAX	MAX	MAX					MIN	MIN			TYP	MAX
1.6	1.5	40	3	30	0.6	225/188	450	350	210	125	2	35
1.6	1.5	40	3	30	0.6	225/188	450	350	210	125	2	35
1.6	1.5	40	3	30	0.6	225/188	425	325	210	125	2	35
1.6	1.5	40	3	30	0.6	225/188	400	300	210	125	2	35
1.6	1.5	40	3	30	0.6	225/188	200		210	125	2	35
1.6	1.5	40	3	30	0.6	225/188	450	350	210	125	2	35
1.6	1.5	40	3	30	0.6	225/188	450	350	210	125	2	35
1.6	1.5	40	3	30	0.6	225/188	425	325	210	125	2	35
1.6	1.5	40	3	30	0.6	225/188	400	300	210	125	2	35
1.6	1.5	40	3	30	0.6	225/188	200		210	125	2	35
1.6	1.5	40	3	30	0.6	300/255	450	350	374	125	2	35
1.6	1.5	40	3	30	0.6	300/255	450	350	374	125	2	35
1.6	1.5	40	3	30	0.6	300/255	425	325	374	125	2	35
1.6	1.5	40	3	30	0.6	300/255	400	300	374	125	2	35
1.6	1.5	40	3	30	0.6	300/255	200		374	125	2	35
1.6	1.5	50	3.5	35	0.8	350/300	450	350	510	150	2	35
1.6	1.5	50	3.5	35	0.8	350/300	450	350	510	150	2	35
1.6	1.5	50	3.5	35	0.8	350/300	425	325	510	150	2	35
1.6	1.5	50	3.5	35	0.8	350/300	400	300	510	150	2	35
1.6	1.5	50	3.5	35	0.8	350/300	200		510	150	2	35
1.8	1.5	50	3.5	35	0.8	500/425	450	350	1035	150	2	35
1.8	1.5	50	3.5	35	0.8	500/425	450	350	1035	150	2	35
1.8	1.5	50	3.5	35	0.8	500/425	425	325	1035	150	2	35
1.8	1.5	50	3.5	35	0.8	500/425	400	300	1035	150	2	35
1.8	1.5	50	3.5	35	0.8	500/425	200		1035	150	2	35
1.8	1.5	60	3.5	35	0.8	520/430	650	550	1122	175	2.5	35
1.8	1.5	60	3.5	35	0.8	520/430	650	550	1122	175	2.5	35
1.8	1.5	60	3.5	35	0.8	520/430	600	500	1122	175	2.5	35
1.8	1.5	60	3.5	35	0.8	520/430	500	475	1122	175	2.5	35
1.8	1.5	60	3.5	35	0.8	520/430	250		1122	175	2.5	35
1.8	1.5	60	4	40	0.8	650/550	650	550	1750	175	2.5	35
1.8	1.5	60	4	40	0.8	650/550	650	550	1750	175	2.5	35
1.8	1.5	60	4	40	0.8	650/550	600	500	1750	175	2.5	35
1.8	1.5	60	4	40	0.8	650/550	500	475	1750	175	2.5	35
1.8	1.5	60	4	40	0.8	650/550	250		1750	175	2.5	35
1.8	2	80	5	50	1	950/800	650	550	3745	200	2.5	35
1.8	2	80	5	50	1	950/800	650	550	3745	200	2.5	35
1.8	2	80	5	50	1	950/800	600	500	3745	200	2.5	35
1.8	2	80	5	50	1	950/800	500	475	3745	200	2.5	35
1.8	2	80	5	50	1	950/800	250		3745	200	2.5	35
1.8	2	80	5	50	1	950/800	650	550	3745	200	2.5	35
1.8	2	80	5	50	1	950/800	650	550	3745	200	2.5	35
1.8	2	80	5	50	1	950/800	600	500	3745	200	2.5	35
1.8	2	80	5	50	1	950/800	500	475	3745	200	2.5	35

See "General Notes" on page E6 - 2 and "Electrical Specification Notes" on page E6 - 3.

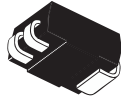
Thermal Resistance (Steady State) R _{θJC} [R _{θJA}] °C/W (TYP.)											
Pkg. Code	L	F	F2	R	J	W	K	M	D	V	N
Type											
	TO-220 Isolated	TO-202 Type 1 Non-isolated	TO-202 Type 2 Non-isolated	TO-220 Non-isolated	TO-218X Isolated	TO-218X Non-isolated	TO-218 Isolated	TO-218 Non-isolated	TO-252 D-Pak Surface Mount	TO-251AA V-Pak Non-isolated	TO-263 D²Pak Non-isolated
1 A	See below										
6 A	4.0 [50]	4.3 [45]	9.5 [70]						1.7	2.3 [70]	
8 A	3.4	3.9		1.8 [40]					1.5	2.0	
10 A	3.0	3.4		1.6					1.45	1.7	
12 A				1.5					1.4	1.6	
15 A	2.5										
16 A				1.3							1.3
20 A	2.4										
25 A	2.35			1.0							1.0
35 A					0.70		0.70				
40 A				0.6							0.6
55 A				0.5		0.53		0.53			0.5
65 A					0.86		0.86				
70 A						0.60					

Thermal Resistance (Steady State) R _{θJC} [R _{θJA}] °C/W (TYP.)		
Package Code	C	E
Type		
	Compak	TO-92
1 A	35 *	50 [145]

* Mounted on 1cm² copper foil surface; two-ounce copper foil

Electrical Isolation

Teccor's isolated SCR packages will withstand a minimum high potential test of 2500 V ac rms from leads to mounting tab over the device's operating temperature range. The following table shows standard and optional isolation ratings.

Electrical Isolation * from Leads to Mounting Tab			
V AC RMS	TO-220 Isolated	TO-218X Isolated	TO-218 Isolated
2500	Standard	Standard	Standard
4000	Optional **	N/A	N/A

* UL Recognized File #E71639

** For 4000 V isolation, use "V" suffix in part number.

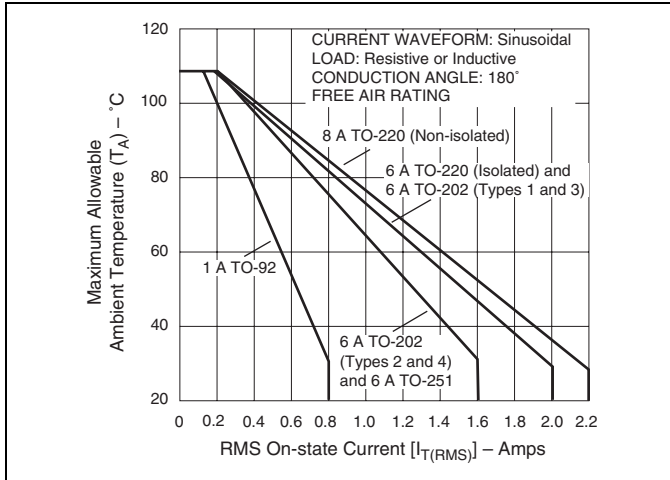

Figure E6.1 Maximum Allowable Ambient Temperature versus RMS On-state Current

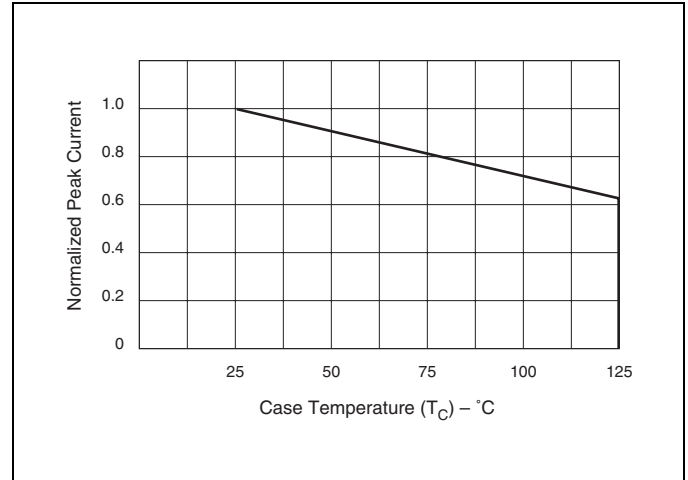

Figure E6.4 Peak Capacitor Discharge Current Derating (6 A through 55 A)

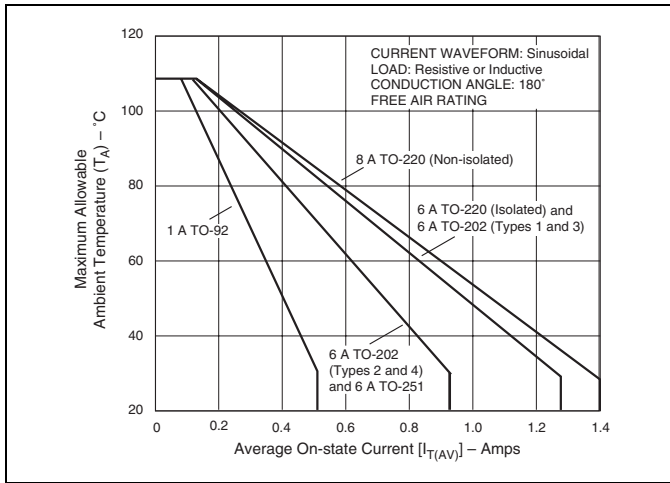

Figure E6.2 Maximum Allowable Ambient Temperature versus Average On-state Current

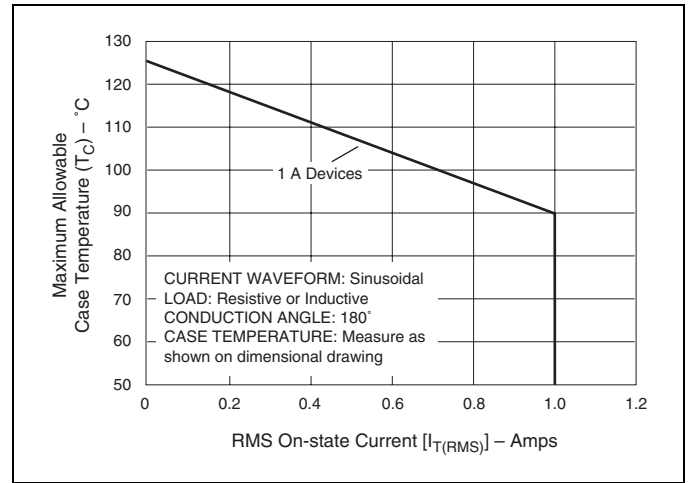

Figure E6.5 Maximum Allowable Case Temperature versus RMS On-state Current (1 A)

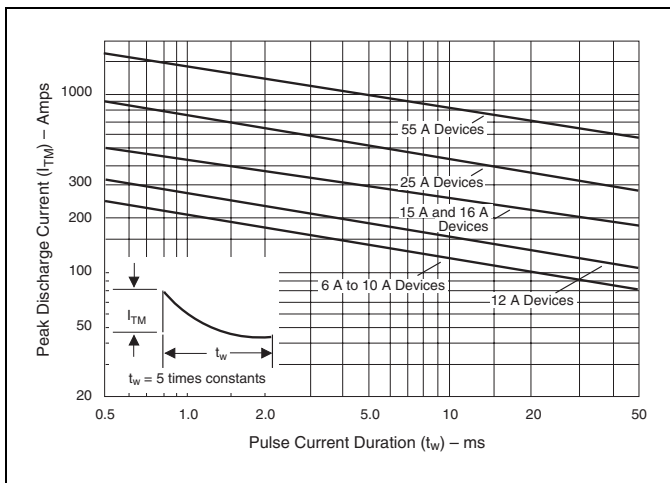

Figure E6.3 Peak Capacitor Discharge Current (6 A through 55 A)

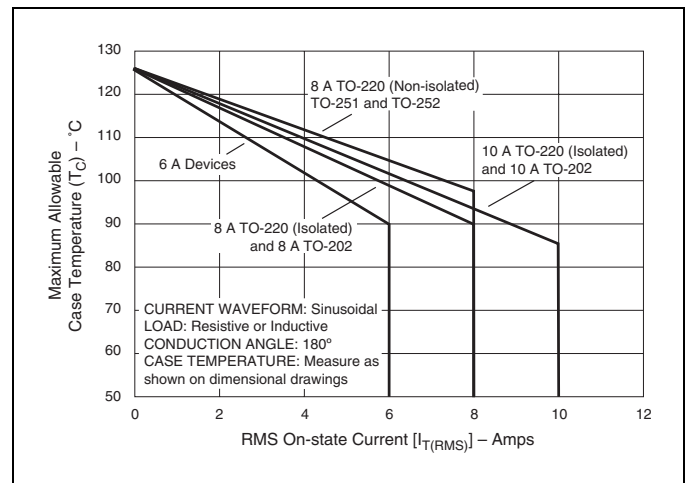

Figure E6.6 Maximum Allowable Case Temperature versus RMS On-state Current (6 A, 8 A, and 10 A)

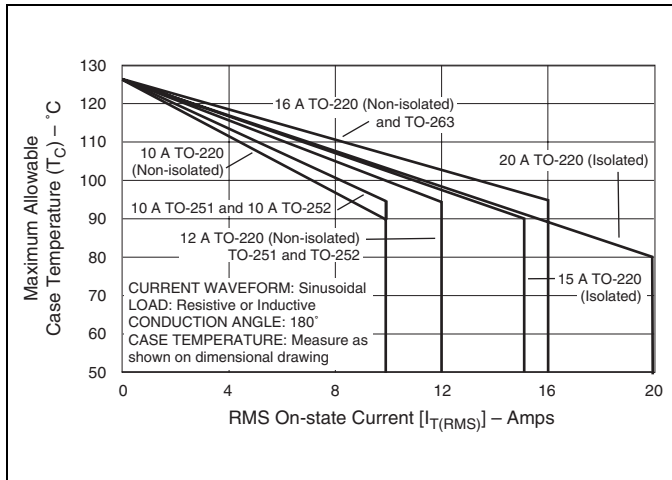

Figure E6.7 Maximum Allowable Case Temperature versus RMS On-state Current (10 A, 12 A, 16 A, and 20 A)

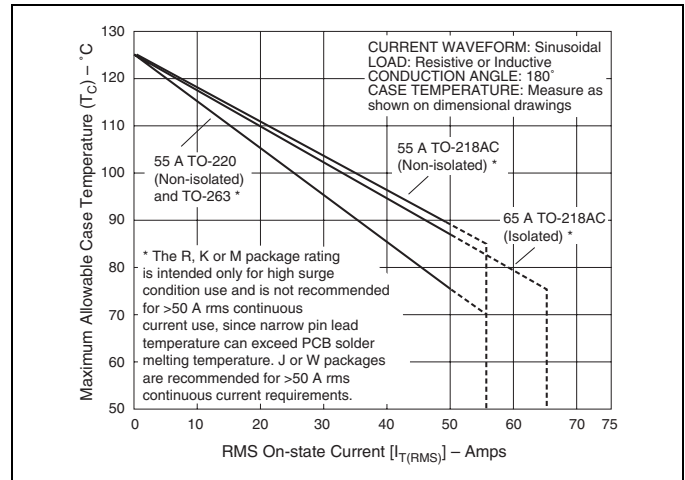

Figure E6.10 Maximum Allowable Case Temperature versus RMS On-state Current (55 A and 65 A)

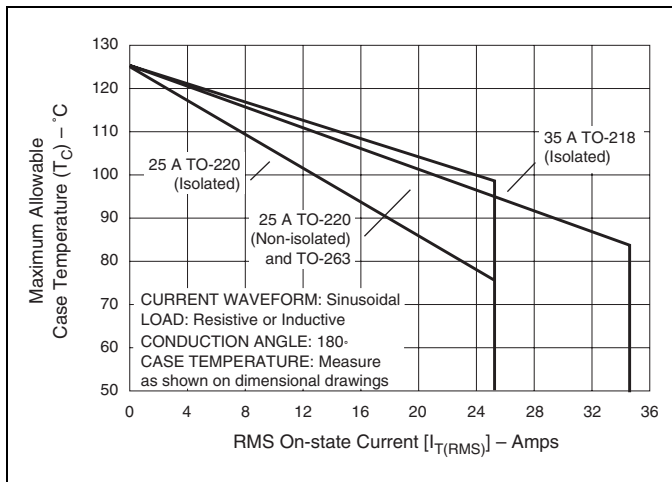

Figure E6.8 Maximum Allowable Case Temperature versus RMS On-state Current (25 A and 35 A)

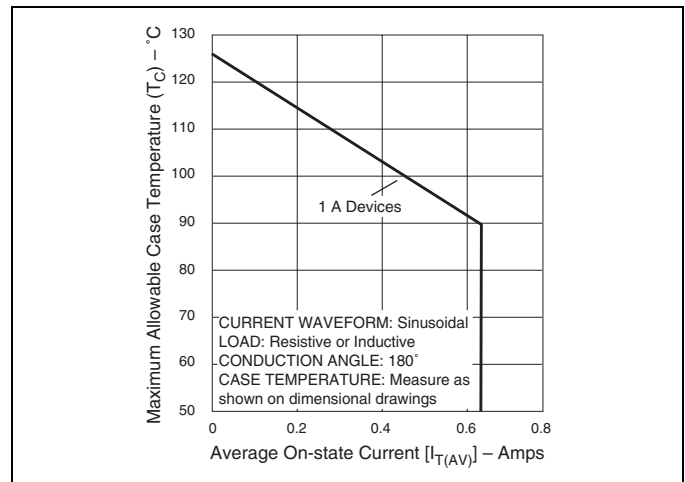

Figure E6.11 Maximum Allowable Case Temperature versus Average On-state Current (1 A)

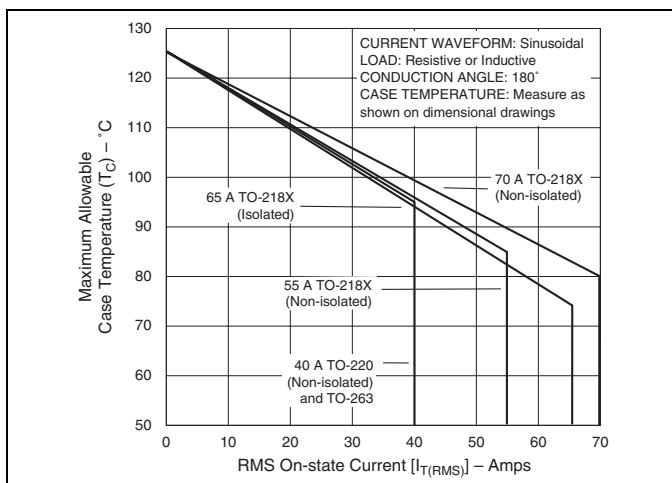

Figure E6.9 Maximum Allowable Case Temperature versus RMS On-state Current (40 A through 70 A)

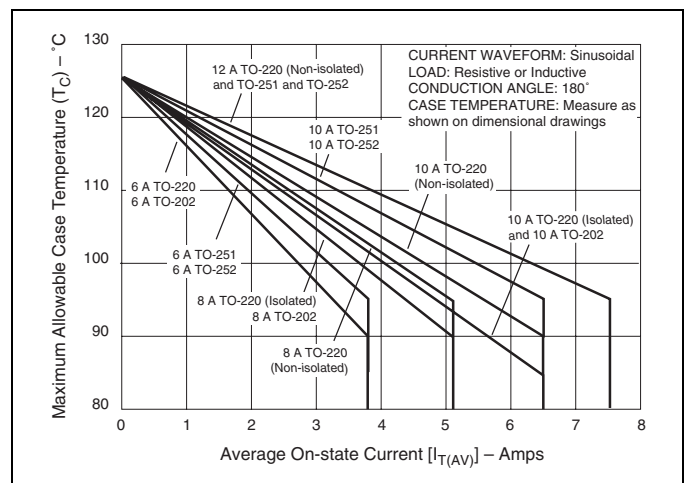

Figure E6.12 Maximum Allowable Case Temperature versus Average On-state Current (8 A, 10 A, and 12 A)

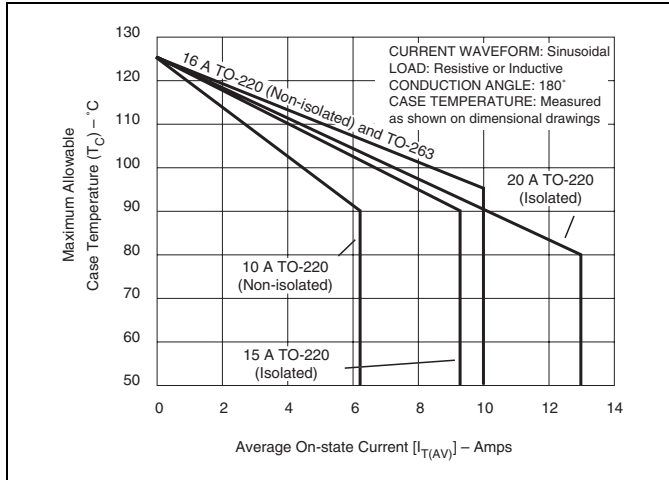

Figure E6.13 Maximum Allowable Case Temperature versus Average On-state Current (10 A through 20 A)

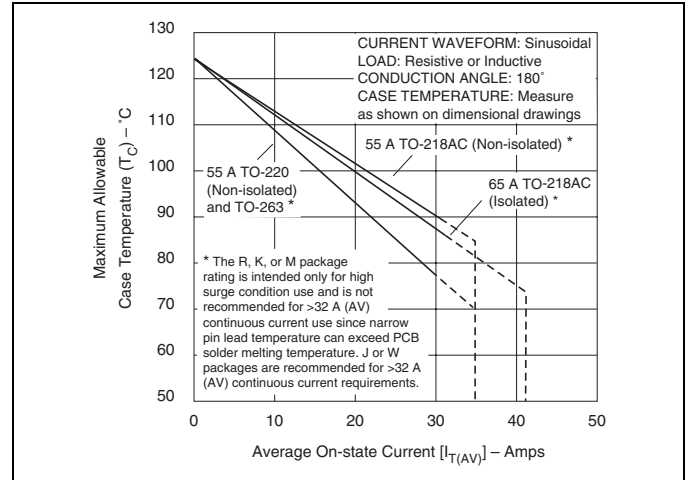

Figure E6.16 Maximum Allowable Case Temperature versus Average On-state Current (55 A and 65 A)

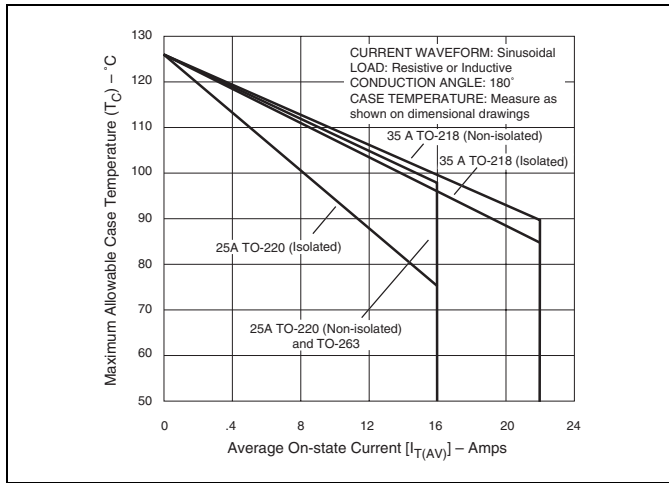

Figure E6.14 Maximum Allowable Case Temperature versus Average On-state Current (25 A and 35 A)

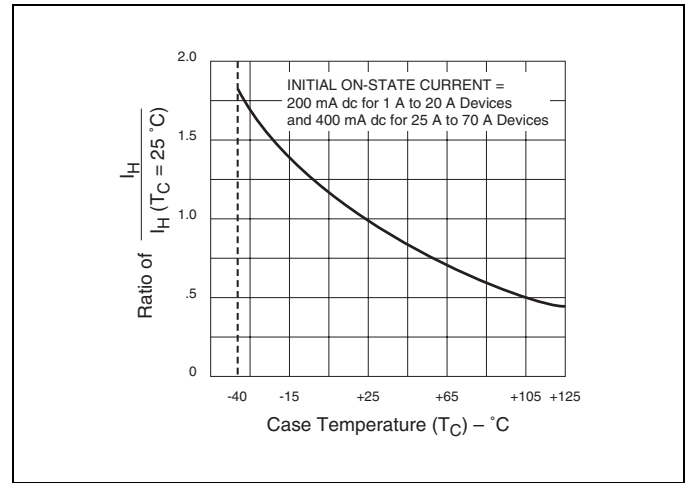

Figure E6.17 Normalized dc Holding Current versus Case Temperature

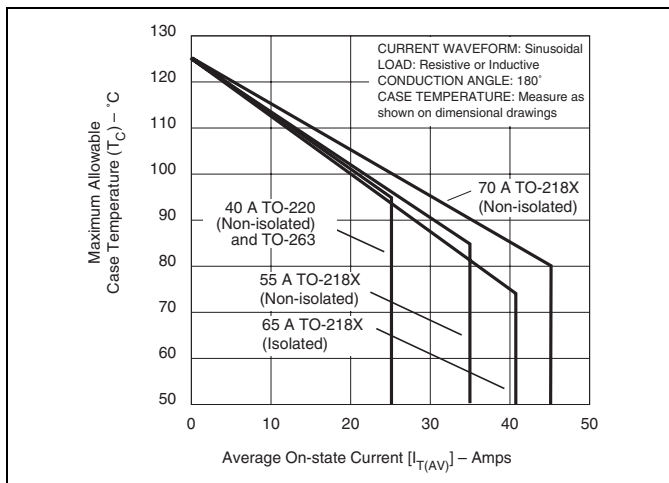

Figure E6.15 Maximum Allowable Case Temperature versus Average On-state Current (40 A through 70 A)

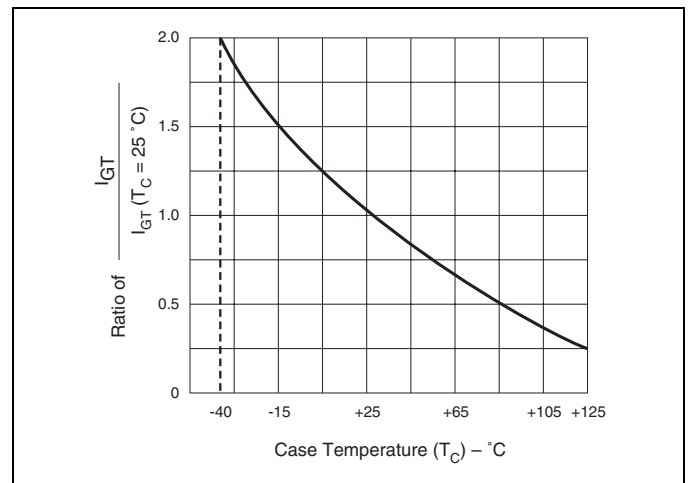

Figure E6.18 Normalized DC Gate-Trigger Current versus Case Temperature

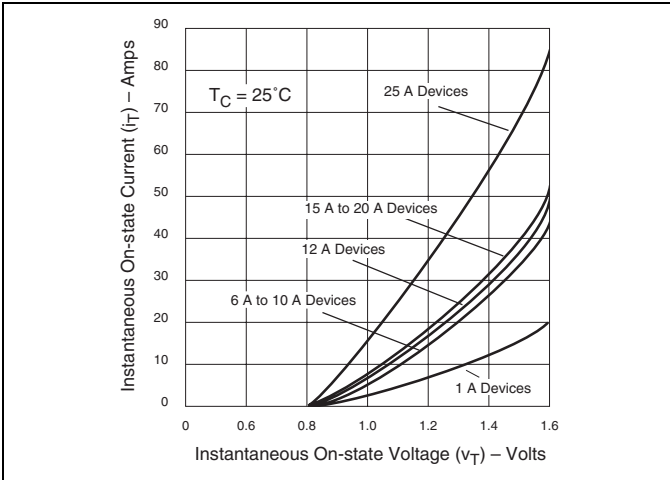

Figure E6.19 Instantaneous On-state Current versus On-state Voltage (Typical) (6 A through 25 A)

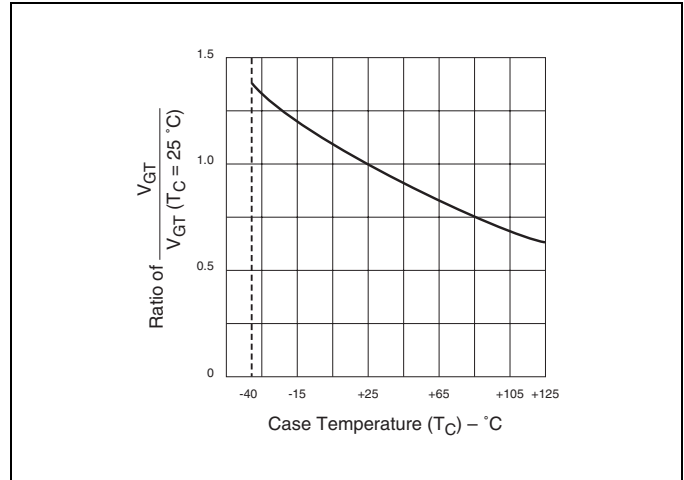

Figure E6.21 Normalized DC Gate-trigger Voltage versus Case Temperature

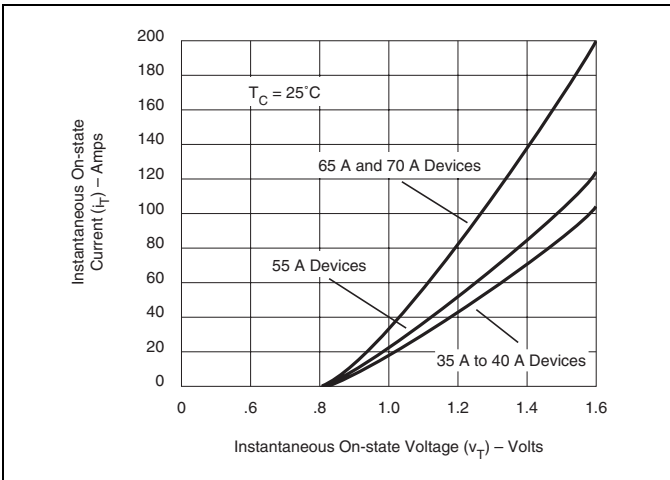

Figure E6.20 Instantaneous On-state Current versus On-state Voltage (Typical) (35 A through 70 A)

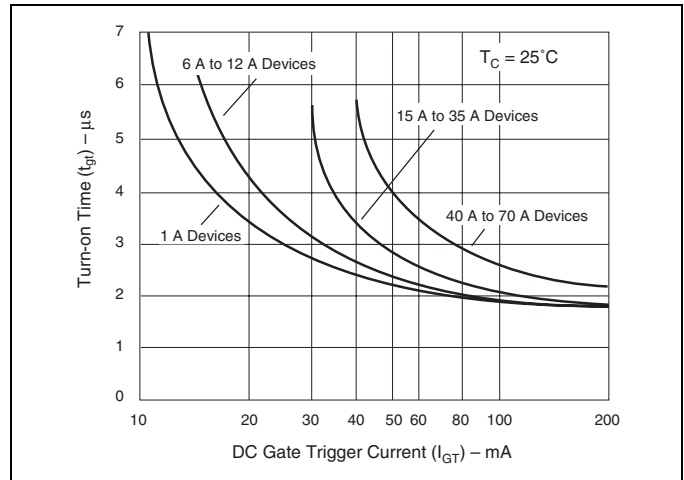

Figure E6.22 Typical Turn-on Time versus Gate-trigger Current

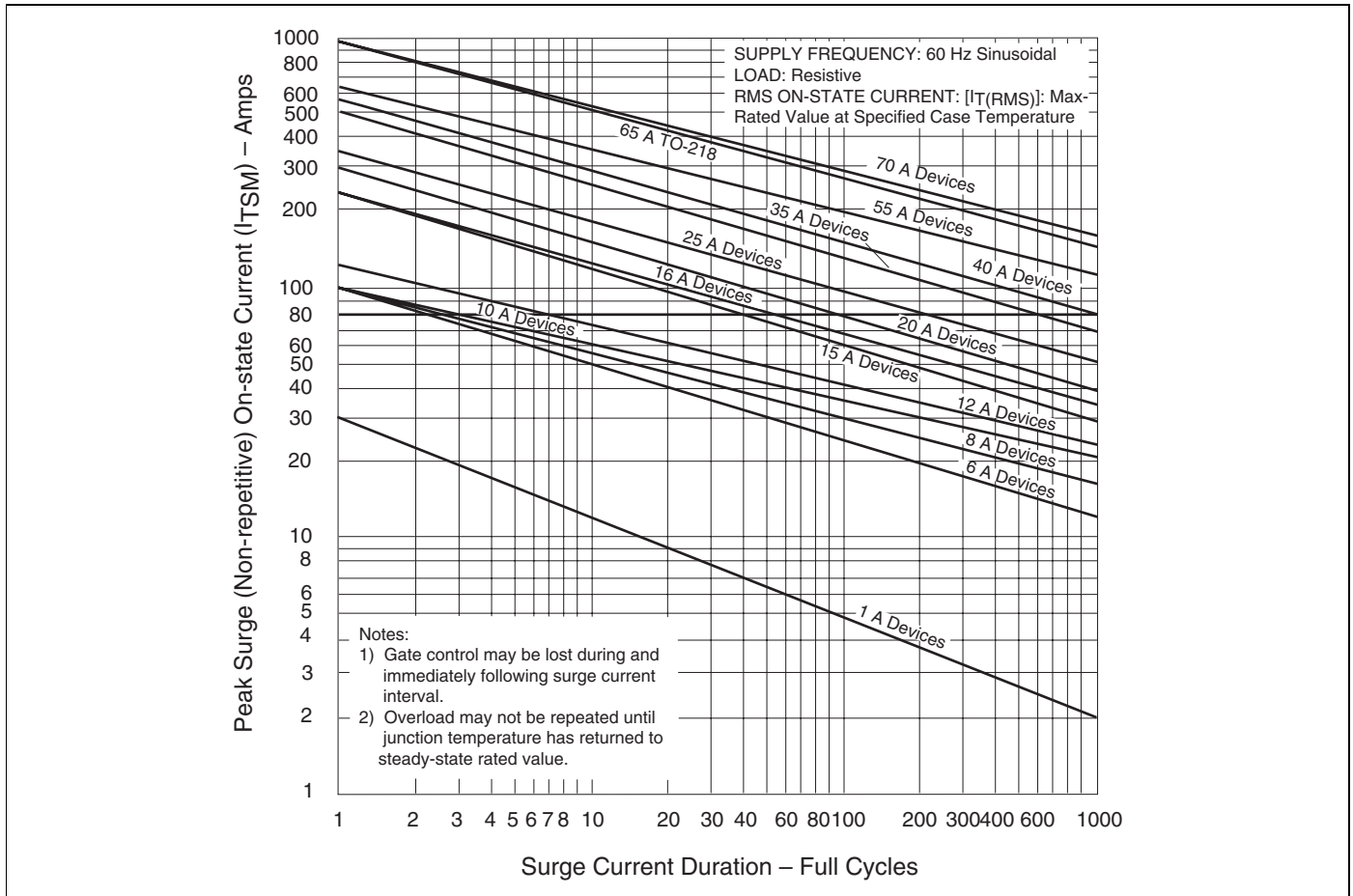

Figure E6.23 Peak Surge Current versus Surge Current Duration

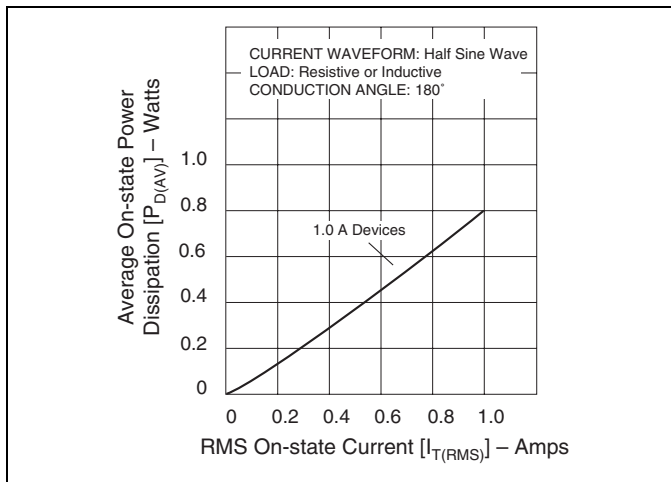

Figure E6.24 Power Dissipation (Typical) versus RMS On-state Current (1 A)

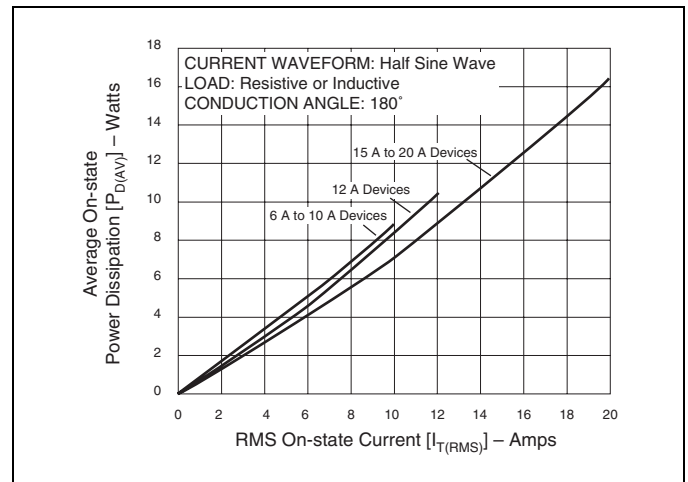

Figure E6.25 Power Dissipation (Typical) versus RMS On-state Current (6 A through 20 A)

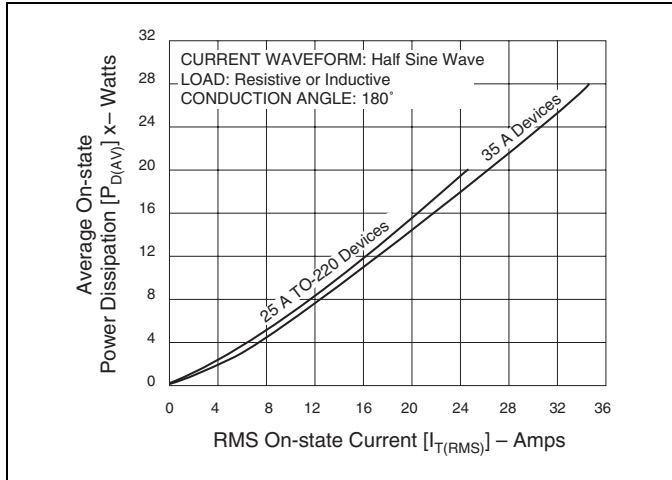

Figure E6.26 Power Dissipation (Typical) versus RMS On-state Current (25 A and 35 A)

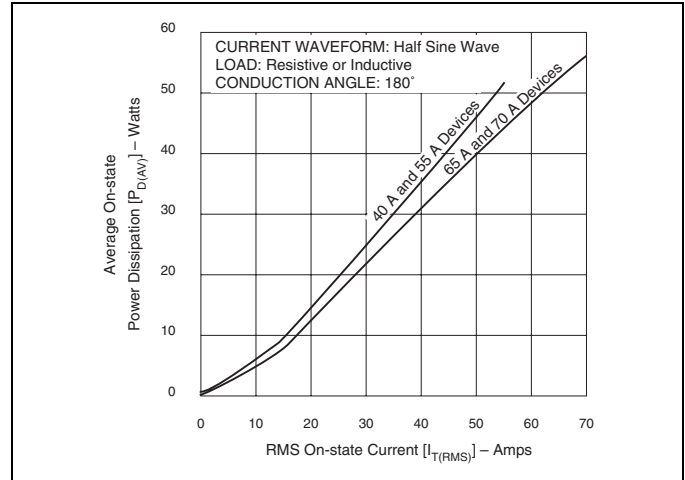
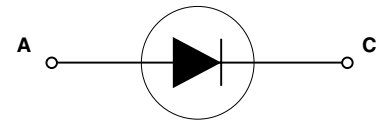
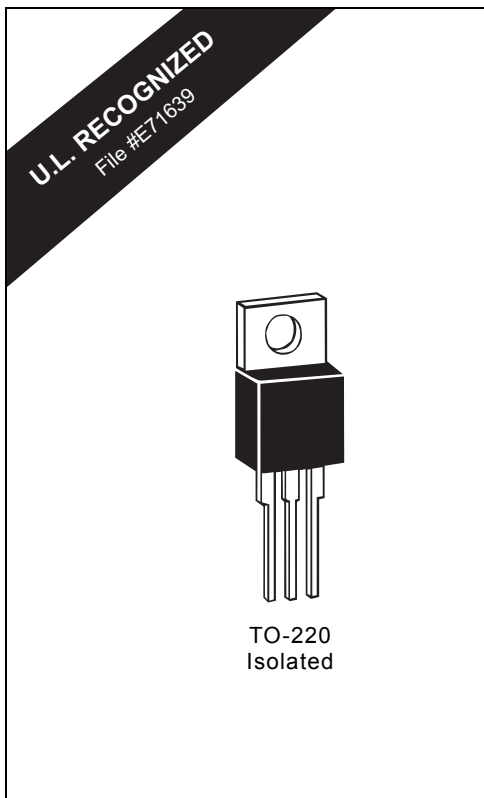

Figure E6.27 Power Dissipation (Typical) versus RMS On-state Current (40 A through 70 A)



Rectifiers

(15 A to 25 A)

General Description

Teccor manufactures 15 A rms to 25 A rms rectifiers with voltages rated from 200 V to 1000 V. Due to the electrically-isolated TO-220 package, these rectifiers may be used in common anode or common cathode circuits using only one part type, thereby simplifying stock requirements.

Teccor's silicon rectifiers feature glass-passivated junctions to ensure long term reliability and stability. In addition, glass offers a rugged, reliable barrier against junction contamination.

Features

- Electrically-isolated packages
- High voltage capabilities — 200 V to 1000 V
- High surge capabilities — up to 350 A
- Glass-passivated junctions

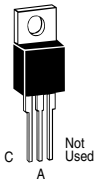
Type	Part Number	V_{RRM}	V_R	$I_{F(AV)}$ (1)	$I_{F(RMS)}$	I_{FSM} (2)	I_{RM} (3)			V_{FM}	i^2t	$R_{\theta JC}$
	Isolated											
	 TO-220											
							Volts	Volts	Amps			
See "Package Dimensions" section for variations. (4)		MIN	MIN	MAX	MAX	MAX			MAX		TYP	
15 A	D2015L	200	200	9.5	15	225/188	0.1	0.5	1	1.6	210	2.85
	D4015L	400	400	9.5	15	225/188	0.1	0.5	1	1.6	210	2.85
	D6015L	600	600	9.5	15	225/188	0.1	0.5	1	1.6	210	2.58
	D8015L	800	800	9.5	15	225/188	0.1	0.5	1	1.6	210	2.85
	DK015L	1000	1000	9.5	15	225/188	0.1	3		1.6	210	2.85
20 A	D2020L	200	200	12.7	20	300/255	0.1	0.5	1	1.6	374	2.5
	D4020L	400	400	12.7	20	300/255	0.1	0.5	1	1.6	374	2.5
	D6020L	600	600	12.7	20	300/255	0.1	0.5	1	1.6	374	2.5
	D8020L	800	800	12.7	20	300/255	0.1	0.5	1	1.6	374	2.5
	DK020L	1000	1000	12.7	20	300/255	0.1	3		1.6	374	2.5
25 A	D2025L	200	200	15.9	25	350/300	0.1	0.5	1	1.6	508	2.7
	D4025L	400	400	15.9	25	350/300	0.1	0.5	1	1.6	508	2.7
	D6025L	600	600	15.9	25	350/300	0.1	0.5	1	1.6	508	2.7
	D8025L	800	800	15.9	25	350/300	0.1	0.5	1	1.6	508	2.7
	DK025L	1000	1000	15.9	25	350/300	0.1	3		1.6	508	2.7

Test Conditions

- i^2t — RMS surge (non-repetitive) forward current for 8.3 ms for fusing
- $I_{F(AV)}$ — Average forward current
- $I_{F(RMS)}$ — RMS forward current
- I_{FSM} — Peak one-cycle surge current
- I_{RM} — Peak reverse current
- $R_{\theta JC}$ — Thermal resistance (steady state) junction to case
- V_{FM} — Peak forward voltage at rated average forward current
- V_R — DC blocking voltage
- V_{RRM} — Peak repetitive reverse voltage

General Notes

- Operating temperature range (T_J) is $-40^\circ C$ to $+125^\circ C$.
- Storage temperature range (T_S) is $-40^\circ C$ to $+125^\circ C$.
- Lead solder temperature is a maximum of $230^\circ C$ for 10 seconds maximum at a minimum of 1/16" (1.59 mm) from case.
- The case temperature (T_C) is measured as shown on dimensional outline drawings in the "Package Dimensions" section of this catalog.
- Teccor's electrically-isolated TO-220 devices withstand a high potential test of 2500 V ac rms from leads to mounting tab over the operating temperature range.
- Typical Reverse Recovery Time (t_{rr}) is 4 μs . (Test conditions = 0.9 A forward current and 1.5 A reverse current)

Electrical Specification Notes

- See Figure E7.3 for current rating at specified case temperature.
- For more than one full cycle rating, see Figure E7.4.
- $T_C = T_J$ for test conditions
- See package outlines for lead form configurations. When ordering special lead forming, add type number as suffix to part number.

Electrical Isolation

Electrical Isolation from Leads to Mounting Tab *	
V AC RMS	TO-220 Isolated
2500	Standard
4000	Optional **

* UL Recognized File #E71639

** For 4000 V isolation, use "V" suffix in the part number.

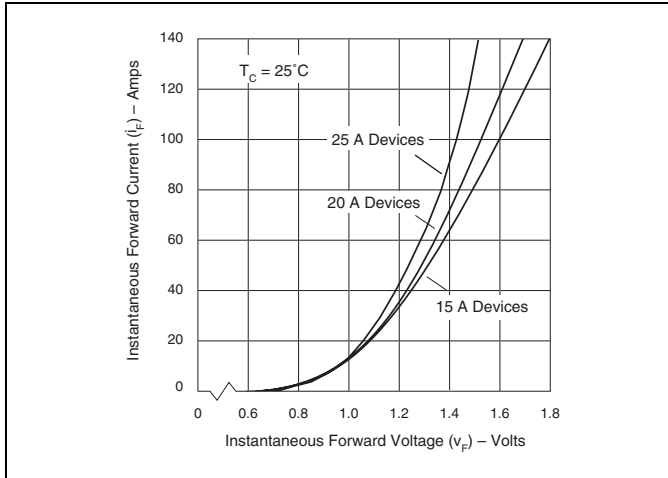

Figure E7.1 Instantaneous Forward Current versus Forward Voltage (Typical)

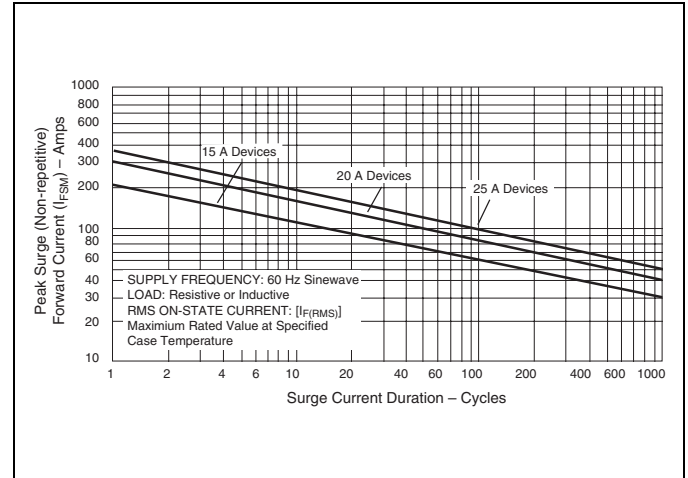

Figure E7.4 Peak Surge Forward Current versus Surge Current Duration

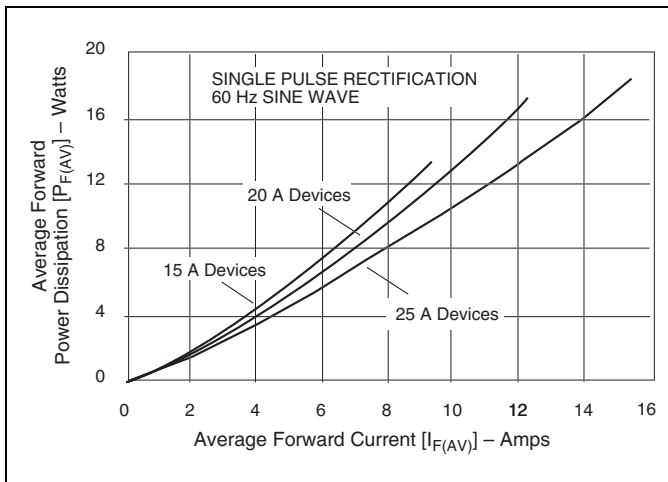

Figure E7.2 Forward Power Dissipation (Typical)

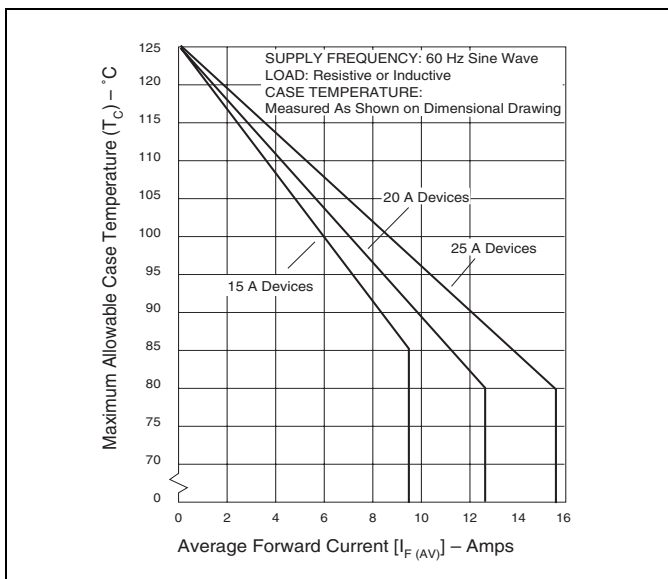
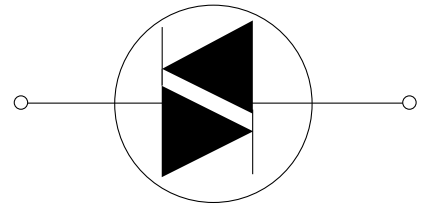
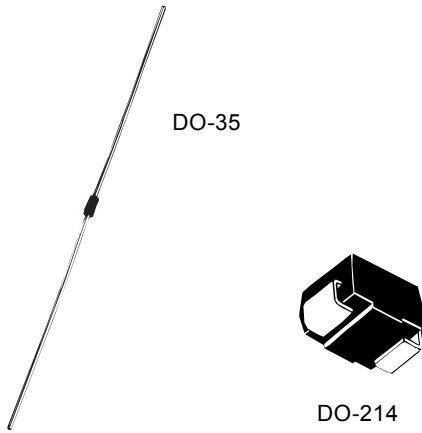

Figure E7.3 Maximum Allowable Case Temperature versus Average Forward Current

Notes

E8

Diac

HT and ST Series

General Description

Teccor's HT and ST Series of bilateral trigger diacs offer a range of voltage characteristics from 27 V to 45 V.

A diac semiconductor is a full-wave or bidirectional thyristor. It is triggered from a blocking- to conduction-state for either polarity of applied voltage whenever the amplitude of applied voltage exceeds the breakover voltage rating of the diac.

The Teccor line of diacs features glass-passivated junctions to ensure long-term reliability and parameter stability. Teccor's glass offers a rugged, reliable barrier against junction contamination.

The diac specifications listed in this data sheet are for standard products. Special parameter selections such as close tolerance voltage symmetry are available. Consult the factory for more information about custom design applications.

Features



- Bilateral triggering device
- Glass-passivated junctions
- Wide voltage range selections

ST Series

- Epoxy SMT package
- High-temperature, solder-bonded die attachment

HT Series

- DO-35 trigger package
- Pre-tinned leads

Electrical Characteristics $T_C = 25^\circ\text{C}$							
Part No.		V_{BO}		ΔV_{BO}	V_{BB}	I_{BO}	I_{TRM}
 DO-35	 DO-214	Breakover Voltage (Forward and Reverse)		Breakover Voltage Symmetry $\Delta V_{BO} = [+V_{BO} - -V_{BO}]$	Dynamic Breakback Voltage (3) $ \Delta V_{\pm} $	Peak Breakover Current at Breakover Voltage	Peak Pulse Current for 10 μs 120 PPS $T_A \leq 40^\circ\text{C}$
		Volts		Volts	Volts	μAmps	Amps
		MIN	MAX	MAX	MIN	MAX	MAX
HT-32	ST-32	27	37	3 (1)	10 (2)	25	2
HT-32A / HT-5761		28	36	2 (1)	7 at 10 mA (4)	25	2
HT-32B / HT-5761A	ST-32B	30	34	2 (1)	7 at 10 mA (4)	25	2
HT-34B	ST-34B	32	36	2 (1)	10 (2)	25	2
HT-35	ST-35	30	40	3 (1)	10 (2)	25	2
HT-36A / HT-5762	ST-36A	32	40	2 (1)	7 at 10 mA (4)	25	2
HT-36B	ST-36B	34	38	2 (1)	10 (2)	25	2
HT-40	ST-40	35	45	3 (1)	10 (2)	25	2

General Notes

- Lead solder temperature is $+230^\circ\text{C}$ for 10-second maximum; $\geq 1/16"$ (1.59 mm) from case.
- See "Package Dimensions" section of this catalog.

Electrical Specification Notes



- (1) Breakover voltage symmetry as close as 1 V is available from the factory on these products.
- (2) See Figure E8.4 and Figure E8.5 for test circuit and waveforms.
- (3) Typical switching time is 900 nano-seconds measured at I_{PK} (Figure E8.4) across a $20\ \Omega$ resistor (Figure E8.5). Switching time is defined as rise time of I_{PK} between the 10% to 90% points.
- (4) See V-I Characteristics.

Bilateral Trigger DIAC Specifications

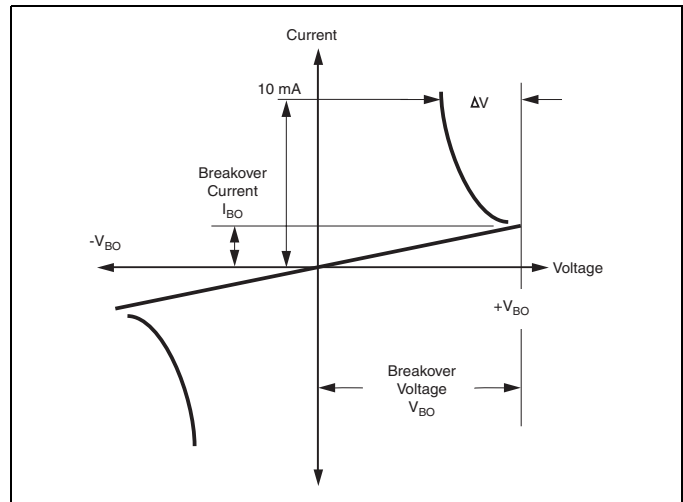
- Maximum Ratings, Absolute-Maximum Values
 - Maximum Trigger Firing Capacitance: 0.1 μF
 - Device dissipation (at $T_A = -40^\circ\text{C}$ to $+40^\circ\text{C}$): 250 mW for DO-35 and 300 mW for DO-214
 - Derate above $+40^\circ\text{C}$: 3.6 mW/ $^\circ\text{C}$ for DO-35 and 3 mW/ $^\circ\text{C}$ for DO-214
- Temperature Ranges
 - Storage: -40°C to $+125^\circ\text{C}$
 - Operating (Junction): -40°C to $+125^\circ\text{C}$



V-I Characteristics

HT and ST Series Thermal Resistance Junction to Lead - $R_{\theta JL}$: $^\circ\text{C/W}$ Junction to Ambient [$R_{\theta JA}$]: $^\circ\text{C/W}$ (based on maximum lead temperature of 90°C for DO-214 and 85°C for DO-35 devices)	
Y Package  DO-35	S Package  DO-214
100 [278] $^\circ\text{C/W}$	65 $^\circ\text{C/W}^*$

* Mounted on 1 cm^2 copper foil surface; two-ounce copper foil

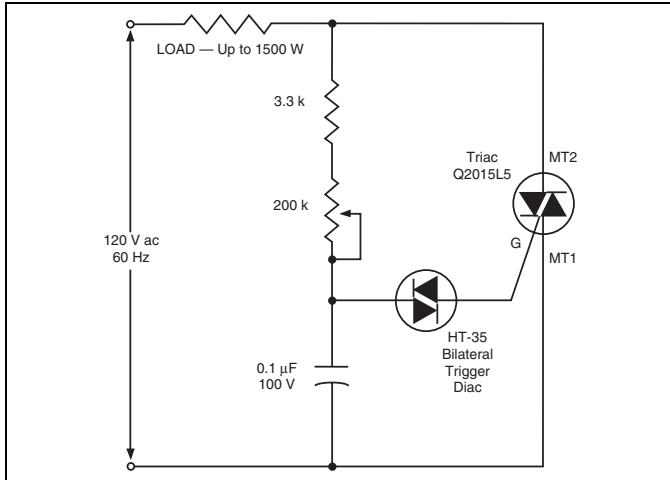

Figure E8.1 Typical Diac/Triac Full-wave Phase Control Circuit Using Lower Voltage Diacs.

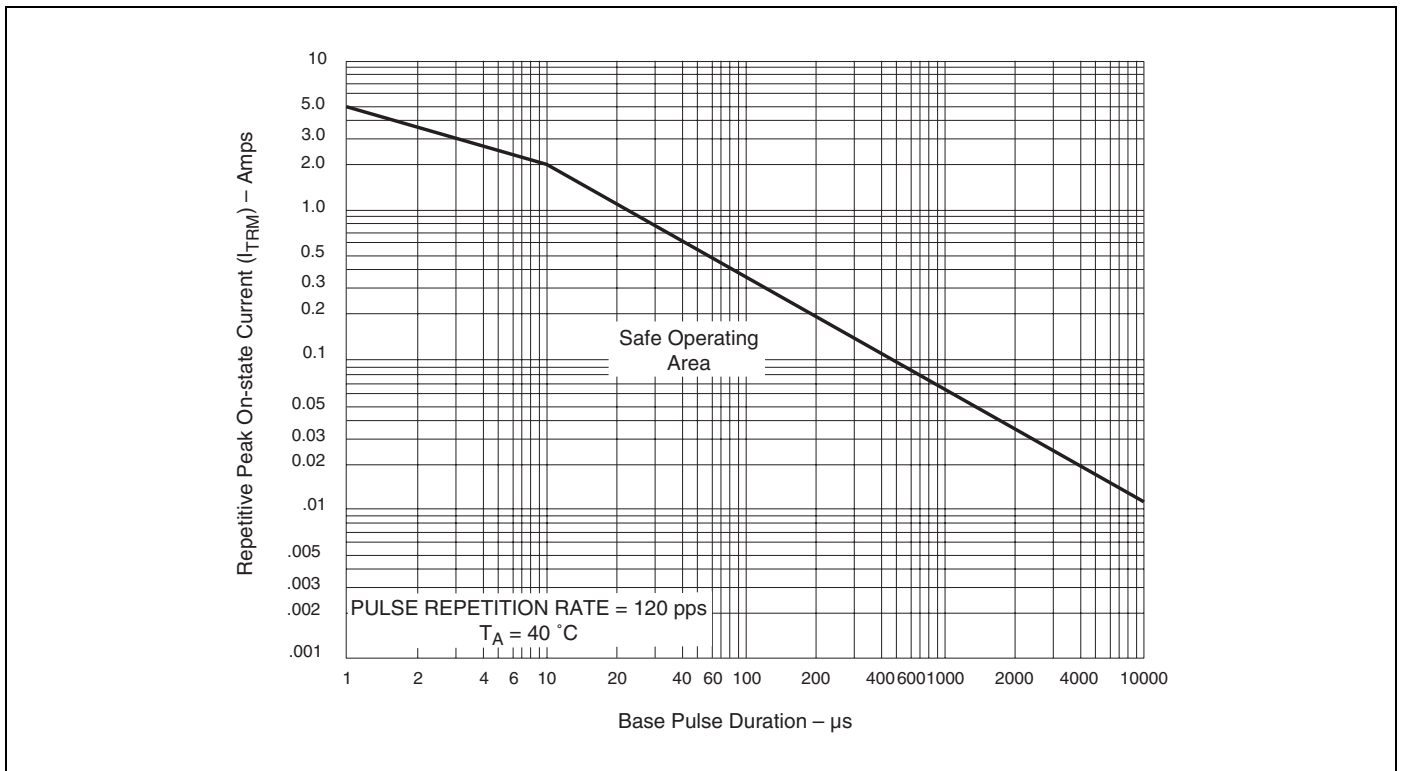

Figure E8.2 Repetitive Peak On-state Current versus Pulse Duration

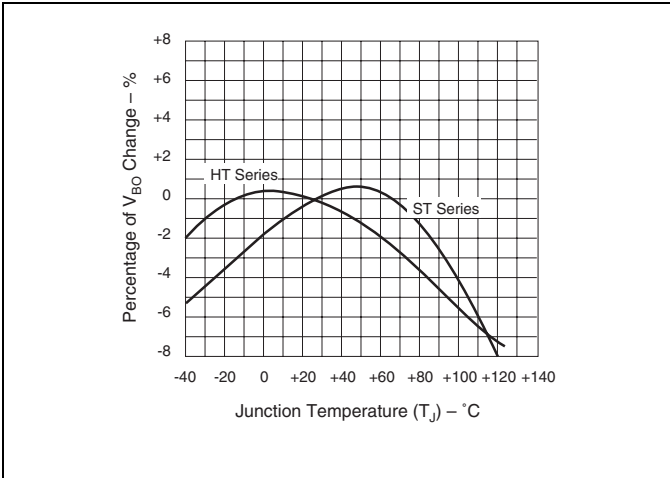

Figure E8.3 Normalized V_{BO} Change versus Junction Temperature

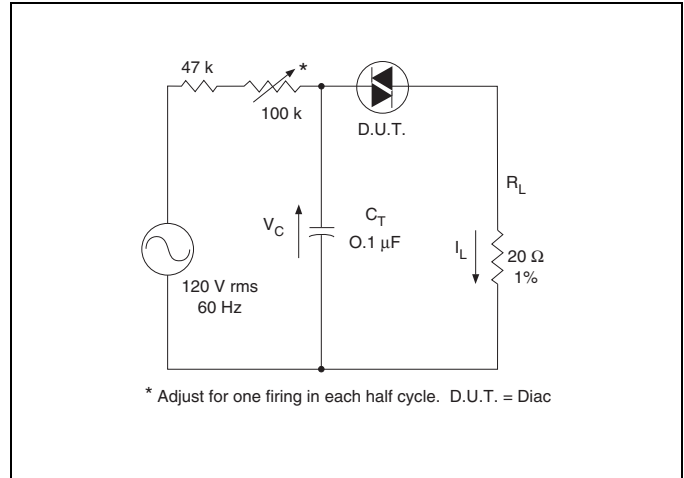

Figure E8.5 Circuit Used to Measure Diac Characteristics (Refer to Figure E8.4.)

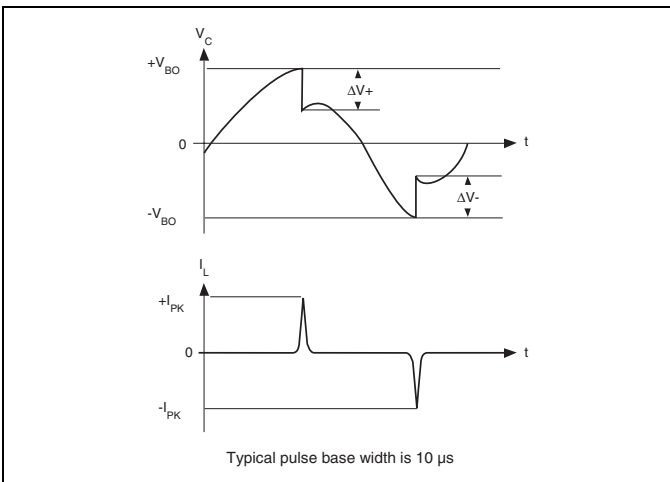

Figure E8.4 Test Circuit Waveforms (Refer to Figure E8.5.)

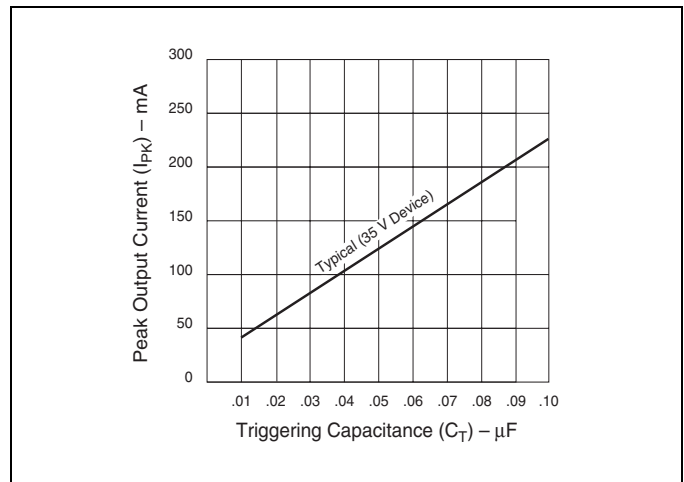
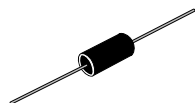
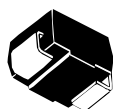

Figure E8.6 Peak Output Current versus Triggering Capacitance (Per Figure E8.5 with R_L of 20 Ω)

E9



DO-15X



DO-214
Surface Mount



TO-202



TO-92
Type 70

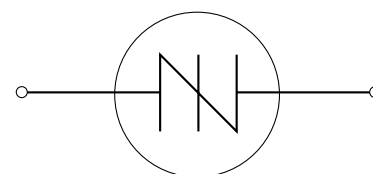

Sidac

(79 V to 330 V)

General Description

The sidac is a silicon bilateral voltage triggered switch with greater power-handling capabilities than standard diacs. Upon application of a voltage exceeding the sidac breakover voltage point, the sidac switches on through a negative resistance region to a low on-state voltage. Conduction continues until the current is interrupted or drops below the minimum holding current of the device.

Teccor's sidacs feature glass-passivated junctions to ensure a rugged and dependable device capable of withstanding harsh environments.



Variations of devices covered in this data sheet are available for custom design applications. Consult the factory for more information.

Applications

- High-voltage lamp ignitors
- Natural gas ignitors
- Gas oil ignitors
- High-voltage power supplies
- Xenon ignitors
- Overvoltage protector
- Pulse generators
- Fluorescent lighting ignitors
- HID lighting ignitors

Features

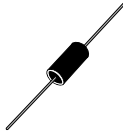
- AC circuit oriented
- Glass-passivated junctions
- High surge current capability

Type	Part No.				$I_{T(RMS)}$	V_{DRM}	V_{BO}		I_{DRM}	I_{BO}	I_H	
			(10) 		(7) (8)		(1)			(2)	(3) (4)	
	TO-92	DO-15X	TO-202	DO-214	Amps	Volts	Volts		µAmps	µAmps	mAmps	
See "Package Dimensions" section for variations. (9)					MAX	MIN	MIN	MAX	MAX	MAX	TYP	MAX
	K0900E70	K0900G		K0900S	1	±70	79	97	5	10	60	150
	K1050E70	K1050G		K1050S	1	±90	95	113	5	10	60	150
	K1100E70	K1100G		K1100S	1	±90	104	118	5	10	60	150
	K1200E70	K1200G		K1200S	1	±90	110	125	5	10	60	150
	K1300E70	K1300G		K1300S	1	±90	120	138	5	10	60	150
	K1400E70	K1400G		K1400S	1	±90	130	146	5	10	60	150
	K1500E70	K1500G		K1500S	1	±90	140	170	5	10	60	150
	K2000E70	K2000G	K2000F1	K2000S	1	±180	190	215	5	10	60	150
	K2200E70	K2200G	K2200F1	K2200S	1	±180	205	230	5	10	60	150
	K2400E70	K2400G	K2400F1	K2400S	1	±190	220	250	5	10	60	150
	K2500E70	K2500G	K2500F1	K2500S	1	±200	240	280	5	10	60	150
			K3000F1		1	±200	270	330	5	10	60	150

Specific Test Conditions

- di/dt — Critical rate-of-rise of on-state current
- dv/dt — Critical rate-of-rise of off-state voltage at rated V_{DRM} ; $T_J \leq 100^\circ C$
- I_{BO} — Breakover current 50/60 Hz sine wave
- I_{DRM} — Repetitive peak off-state current 50/60 Hz sine wave; $V = V_{DRM}$
- I_H — Dynamic holding current 50/60 Hz sine wave; $R = 100 \Omega$
- $I_{T(RMS)}$ — On-state RMS current $T_J \leq 125^\circ C$ 50/60 Hz sine wave
- I_{TSM} — Peak one-cycle surge current 50/60 Hz sine wave (non-repetitive)
- R_S — Switching resistance $R_S = \frac{(V_{BO} - V_S)}{(I_S - I_{BO})}$ 50/60 Hz sine wave
- V_{BO} — Breakover voltage 50/60 Hz sine wave
- V_{DRM} — Repetitive peak off-state voltage
- V_{TM} — Peak on-state voltage; $I_T = 1 A$

General Notes

- All measurements are made at 60 Hz with a resistive load at an ambient temperature of +25 °C unless otherwise specified.
- Storage temperature range (T_S) is -65 °C to +150 °C.
- The case (T_C) or lead (T_L) temperature is measured as shown on the dimensional outline drawings in the "Package Dimensions" section of this catalog.
- Junction temperature range (T_J) is -40 °C to +125 °C.
- Lead solder temperature is a maximum of +230 °C for 10-second maximum; $\geq 1/16"$ (1.59 mm) from case.



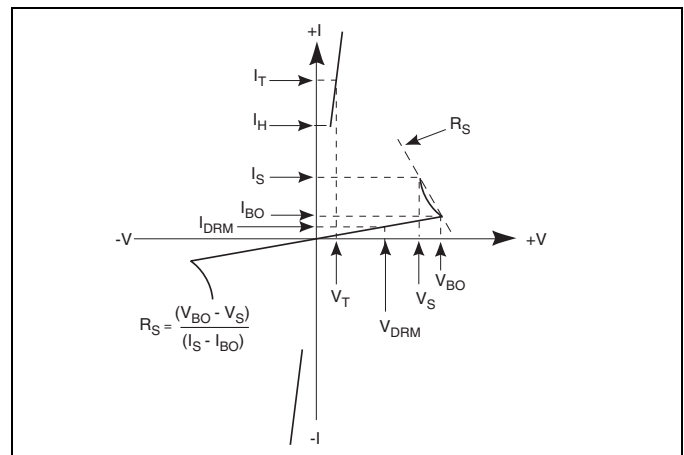

Electrical Specification Notes

- See Figure E9.5 for V_{BO} change versus junction temperature.
- See Figure E9.6 for I_{BO} versus junction temperature.
- See Figure E9.2 for I_H versus case temperature.
- See Figure E9.13 for test circuit.
- See Figure E9.1 for more than one full cycle rating.
- $T_C \leq 90^\circ C$ for TO-92 Sidac
 $T_C \leq 105^\circ C$ for TO-202 Sidacs
 $T_L \leq 100^\circ C$ for DO-15X
 $T_L \leq 90^\circ C$ for DO-214
- See Figure E9.14 for clarification of sidac operation.
- For best sidac operation, the load impedance should be near or less than switching resistance.
- See package outlines for lead form configurations. When ordering special lead forming, add type number as suffix to part number.
- Do not use electrically connected mounting tab or center lead.



V-I Characteristics

V_{TM}				I_{TSM}		R_S	dv/dt	di/dt
Volts MAX				Amps		(8)		
Package				60 Hz	50 Hz	k Ω	Volts/ μ Sec	Amps/ μ Sec
E	G	F	S			MIN	MIN	TYP
1.5	1.5		1.5	20	16.7	0.1	1500	150
1.5	1.5		1.5	20	16.7	0.1	1500	150
1.5	1.5		1.5	20	16.7	0.1	1500	150
1.5	1.5		1.5	20	16.7	0.1	1500	150
1.5	1.5		1.5	20	16.7	0.1	1500	150
1.5	1.5		1.5	20	16.7	0.1	1500	150
1.5	1.5		1.5	20	16.7	0.1	1500	150
1.5	1.5	3	1.5	20	16.7	0.1	1500	150
1.5	1.5	3	1.5	20	16.7	0.1	1500	150
1.5	1.5	3	1.5	20	16.7	0.1	1500	150
1.5	1.5	3	1.5	20	16.7	0.1	1500	150
		3		20	16.7	0.1	1500	150

Thermal Resistance (Steady State) $R_{\theta JC}$ [$R_{\theta JA}$] °C/W (TYPICAL)			
E Package	G Package	F Package	S Package
			
35 [95]	18 [75]	7 [45] **	30 * [85]

* Mounted on 1 cm² copper foil surface; two-ounce copper foil
 ** $R_{\theta JA}$ for TO-202 Type 23 and Type 41 is 70 °C/Watt.

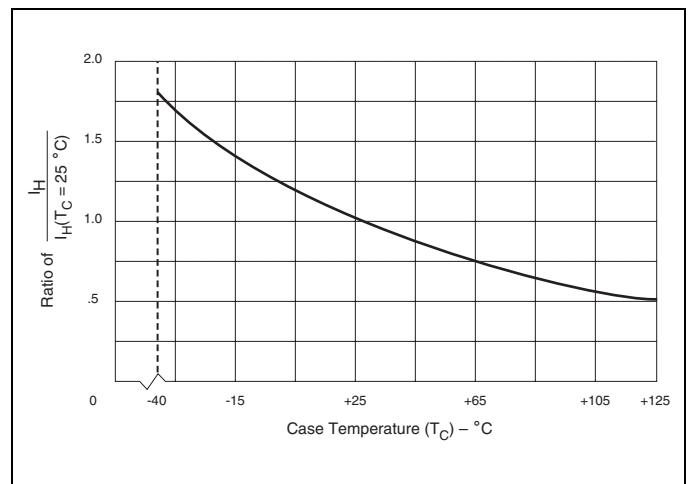

Figure E9.2 Normalized DC Holding Current versus Case/Lead Temperature

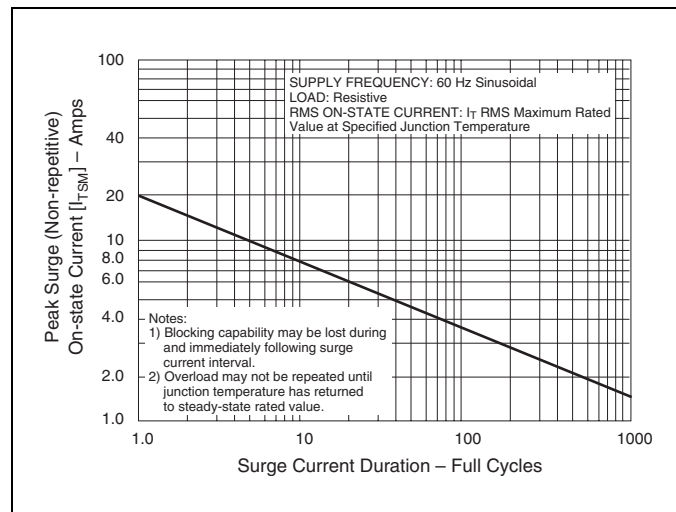

Figure E9.1 Peak Surge Current versus Surge Current Duration

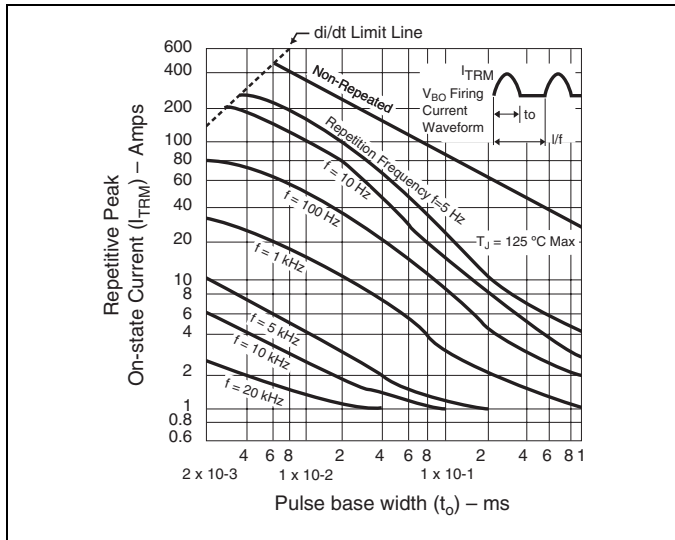

Figure E9.3 Repetitive Peak On-state Current (I_{TRM}) versus Pulse Width at Various Frequencies

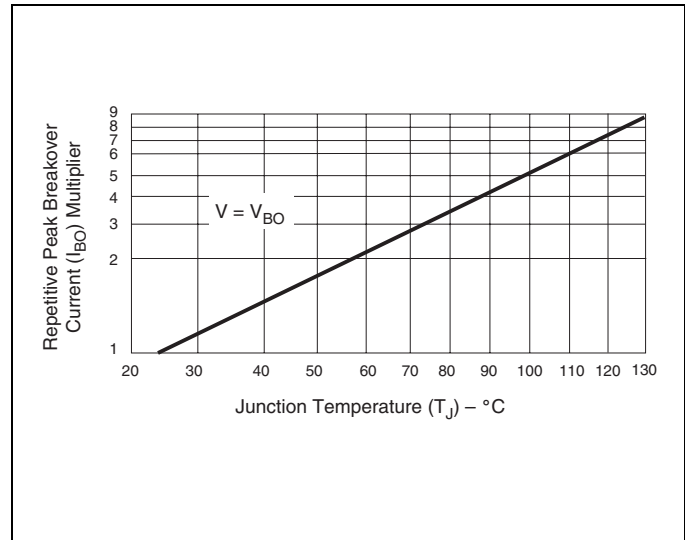

Figure E9.6 Normalized Repetitive Peak Breakover Current versus Junction Temperature

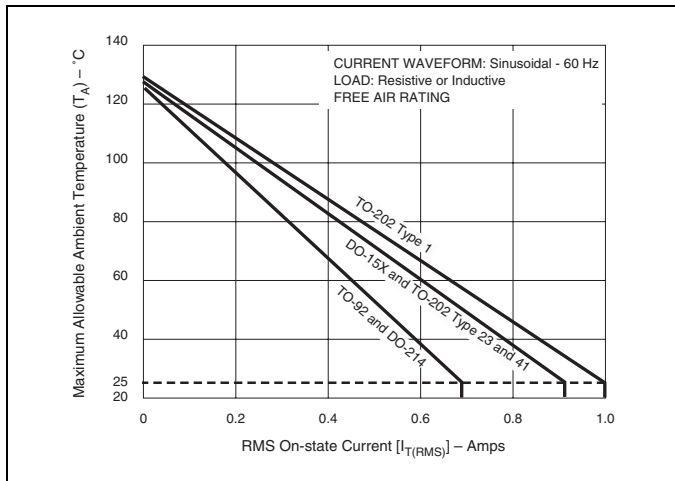

Figure E9.4 Maximum Allowable Ambient Temperature versus On-state Current

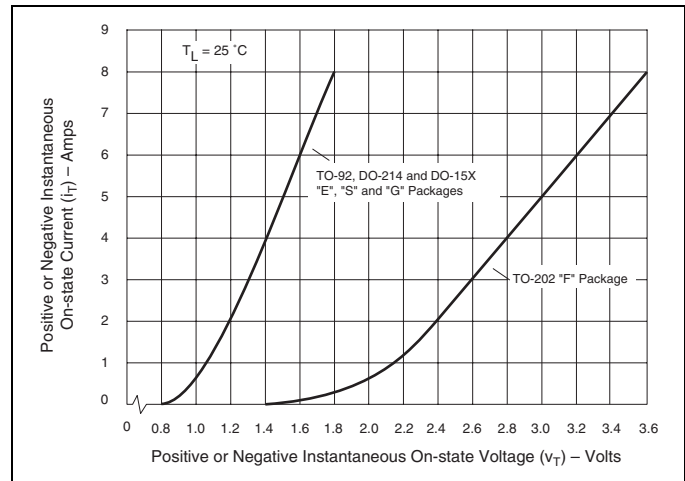

Figure E9.7 On-state Current versus On-state Voltage (Typical)

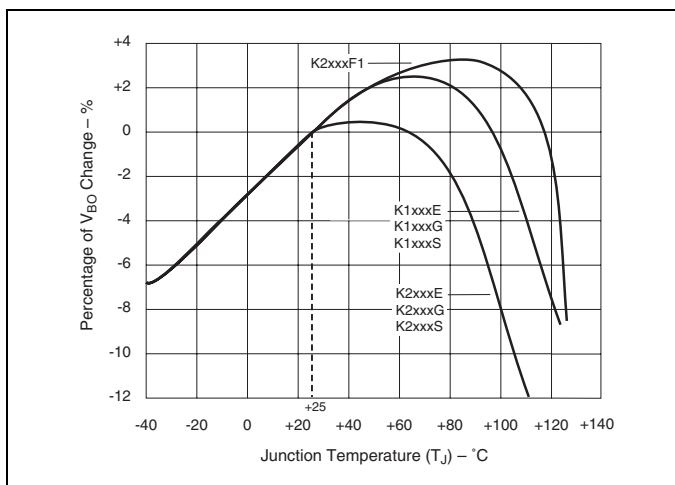

Figure E9.5 Normalized V_{BO} Change versus Junction Temperature

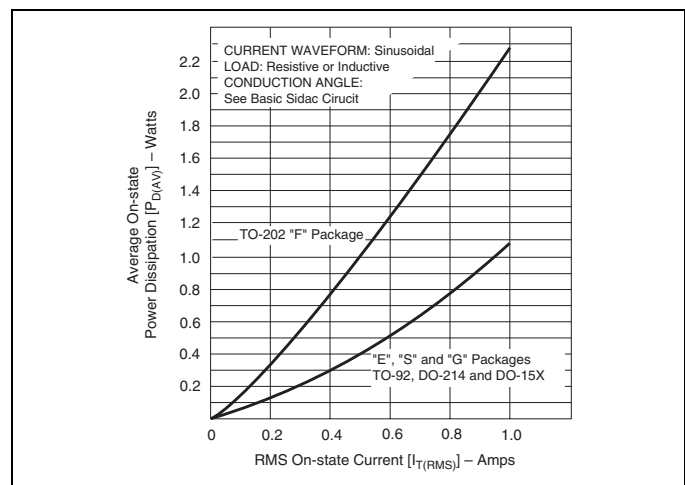

Figure E9.8 Power Dissipation (Typical) versus On-state Current [Refer to Figure E9.14 for Basic Sidac Circuit]

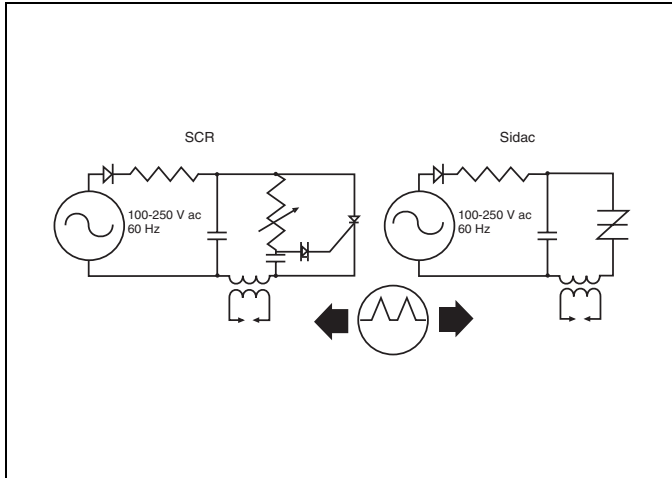

Figure E9.9 Comparison of Sidac versus SCR for Gas Ignitor Circuit

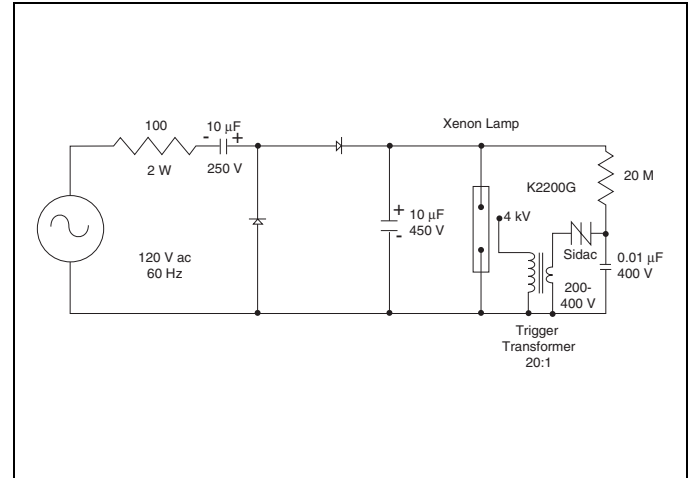

Figure E9.12 Xenon Lamp Flashing Circuit

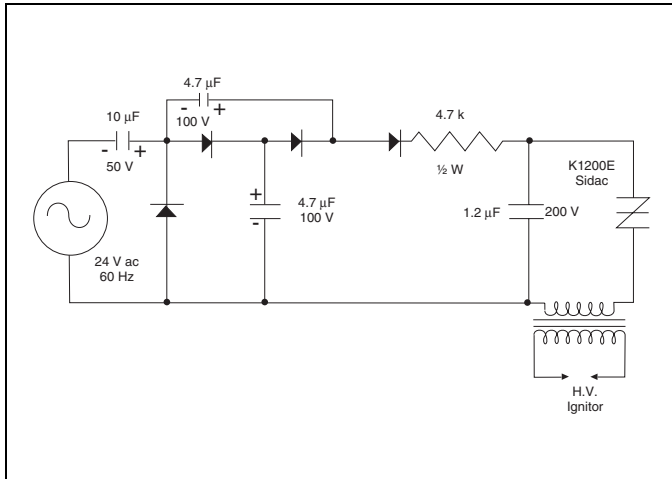

Figure E9.10 Circuit (Low Voltage Input) for Gas Ignition

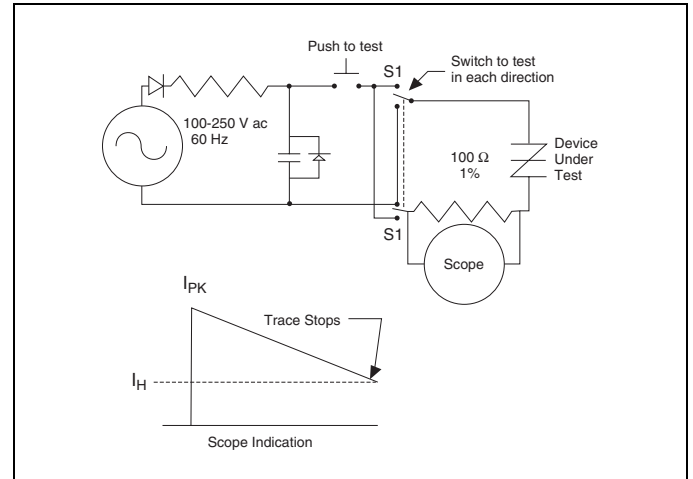

Figure E9.13 Dynamic Holding Current Test Circuit for Sidacs

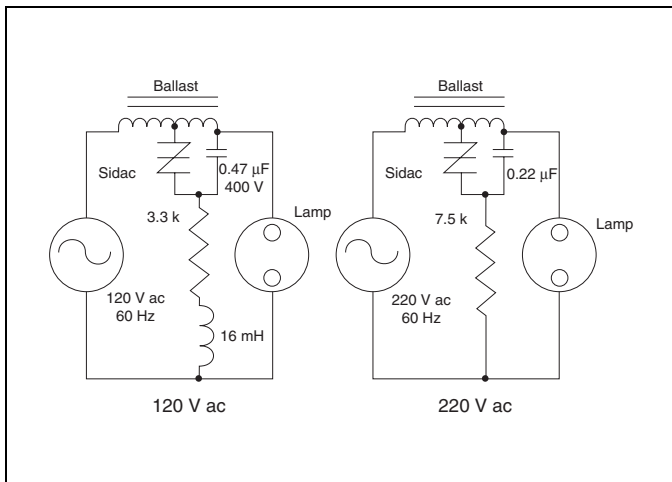

Figure E9.11 Typical High Pressure Sodium Lamp Firing Circuit

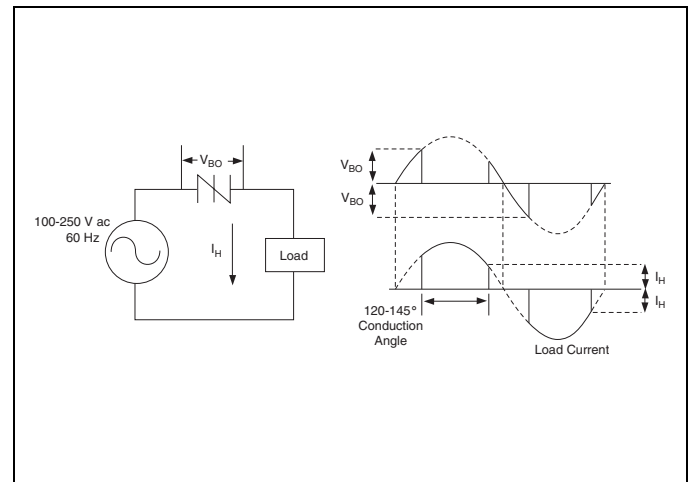

Figure E9.14 Basic Sidac Circuit

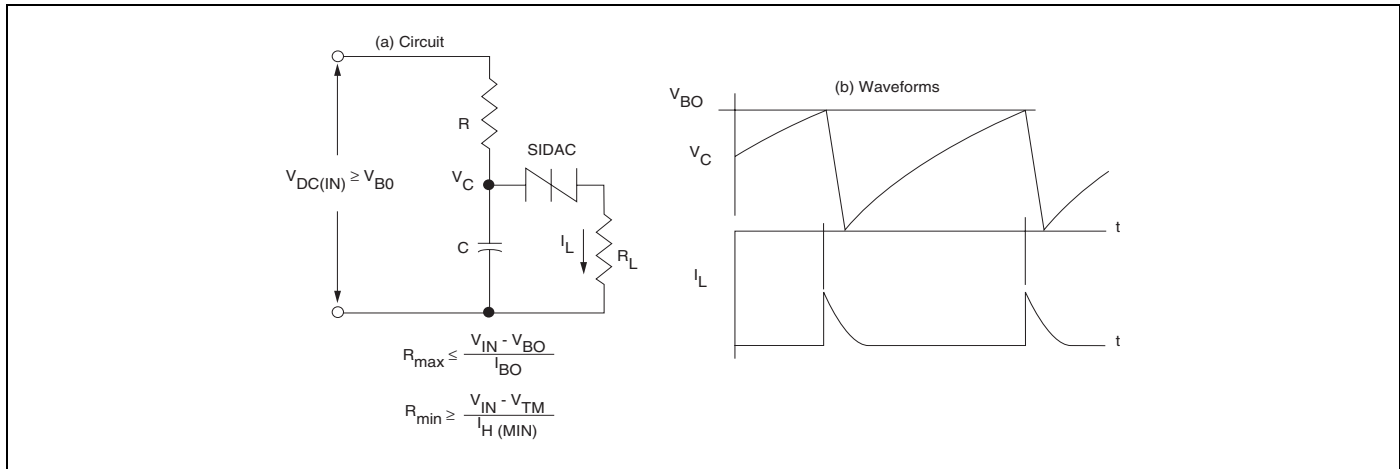

Figure E9.15 Relaxation Oscillator Using a Sidac

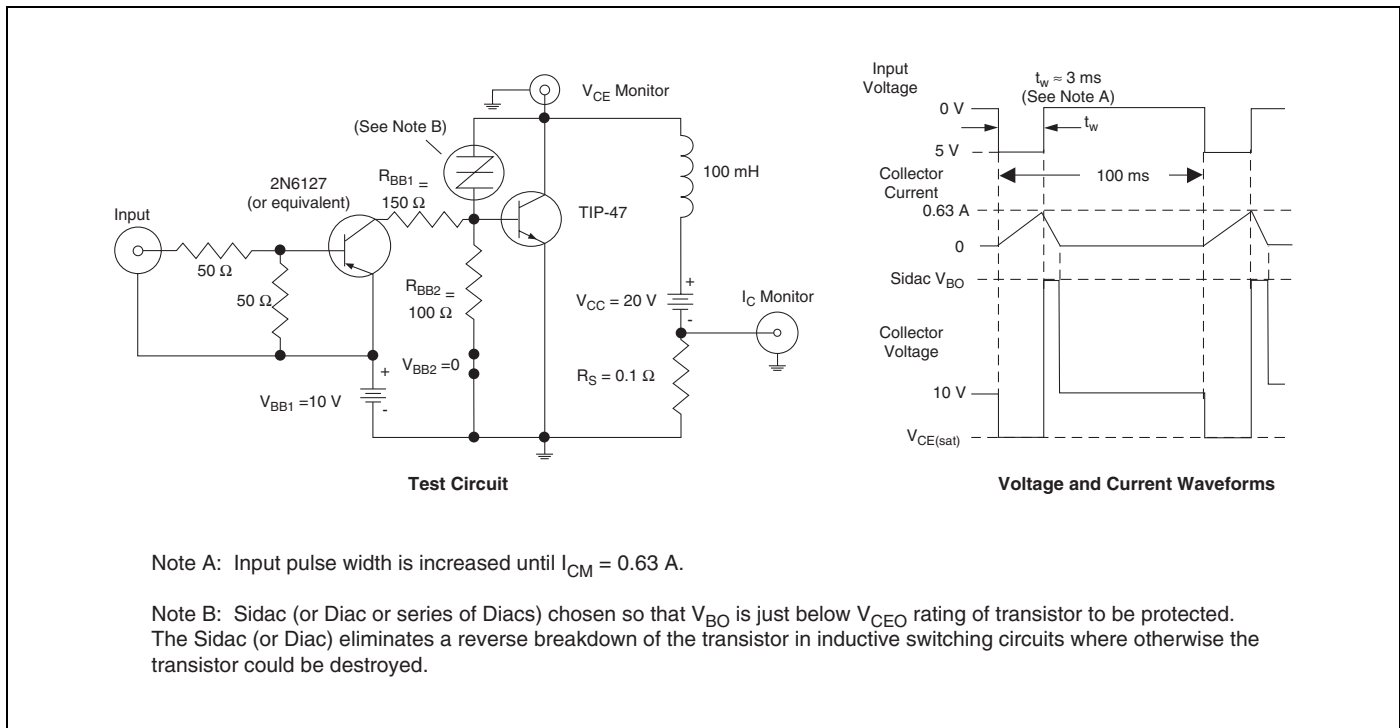

Figure E9.16 Sidac Added to Protect Transistor for Typical Transistor Inductive Load Switching Requirements



Package Dimensions

This section contains the dimensions for the following packages:

- F Package — TO-202AB, Type 1 (Non-isolated)
- Y Package — DO-35 or DO-204AH
- R Package — TO-220AB (Non-isolated)
- L Package — TO-220AB (Isolated)
- P Package — TO-3 Fastpak (Isolated)
- E Package — TO-92 (Isolated)
- S Package — DO-214AA
- M Package — TO-218AC (Non-isolated)
- K Package — TO-218AC (Isolated)
- W Package — TO-218X (Non-isolated)
- J Package — TO-218X (Isolated)
- G Package — DO-15X Axial Lead
- C Package — Compak
- N Package — TO-263
- D Package — TO-252
- V Package — TO-251

F Package — TO-202AB, Type 1
 Non-isolated Mounting Tab Common with MT2 / Anode / PIN 2

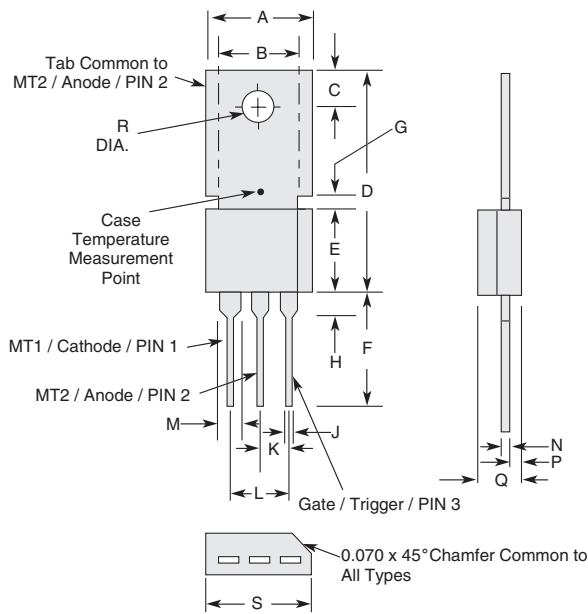

Dimension	Inches		Millimeters	
	MIN	MAX	MIN	MAX
A	0.365	0.385	9.27	9.78
B	0.243	0.253	6.17	6.43
C	0.110	0.120	2.79	3.05
D	0.780	0.810	19.81	20.57
E	0.290	0.310	7.37	7.87
F	0.400	0.430	10.16	10.92
G	0.052	0.062	1.32	1.58
H	0.055	0.065	1.40	1.65
J	0.023	0.029	0.58	0.74
K	0.095	0.105	2.41	2.67
L	0.195	0.205	4.95	5.21
M	0.049	0.059	1.24	1.50
N	0.017	0.023	0.43	0.58
P	0.055	0.065	1.40	1.65
Q	0.175	0.185	4.45	4.70
R	0.124	0.130	3.15	3.30
S	0.390	0.405	9.91	10.29

Notes:

- (1) Maximum torque to be applied to mounting tab is 8 in-lbs. (0.904 Nm)
- (2) Pin 2 and mounting tab are electrically connected. Do not use either for Sidac operation.

Y Package — DO-35 or DO-204AH

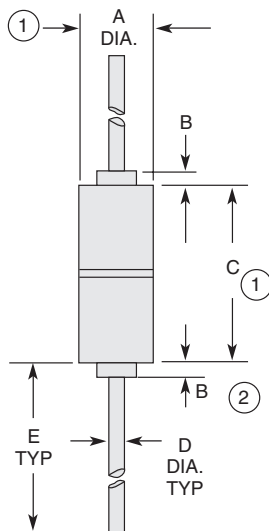

Dimension	Inches		Millimeters	
	MIN	MAX	MIN	MAX
A	0.060	0.090	1.530	2.280
B		0.015		0.381
C	0.135	0.165	3.430	4.190
D	0.018	0.022	0.458	0.558
E	1.000		25.400	

- (1) Package contour optional within dimensions A and C. Slugs, if any, shall be included within this cylinder but shall not be subject to the minimum limit of Dimension A.
- (2) Lead diameter is not controlled in this zone to allow for flash, lead finish build-up, and minor irregularities other than slugs.

R Package — TO-220AB

Non-isolated Mounting Tab Common with Center Lead

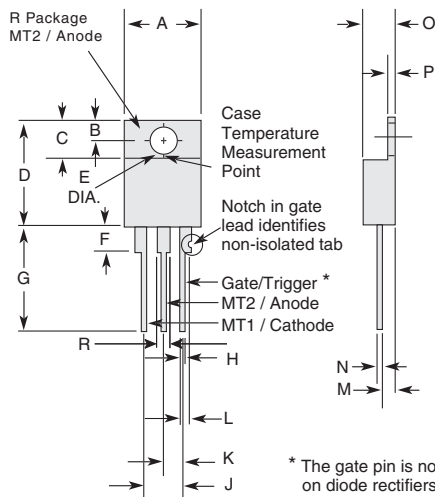

* The gate pin is not used on diode rectifiers.

Note: Maximum torque to be applied to mounting tab is 8 in-lbs. (0.904 Nm).

Dimension	Inches		Millimeters	
	MIN	MAX	MIN	MAX
A	0.380	0.420	9.65	10.67
B	0.105	0.115	2.66	2.92
C	0.230	0.250	5.85	6.35
D	0.590	0.620	14.98	15.75
E	0.142	0.147	3.61	3.73
F	0.110	0.130	2.80	3.30
G	0.540	0.575	13.71	14.60
H	0.025	0.035	0.63	0.89
J	0.195	0.205	4.95	5.21
K	0.095	0.105	2.41	2.67
L	0.060	0.075	1.52	1.91
M	0.070	0.085	1.78	2.16
N	0.018	0.024	0.45	0.61
O	0.178	0.188	4.52	4.78
P	0.045	0.060	1.14	1.53
R	0.038	0.048	0.97	1.22

L Package — TO-220AB

Isolated Mounting Tab

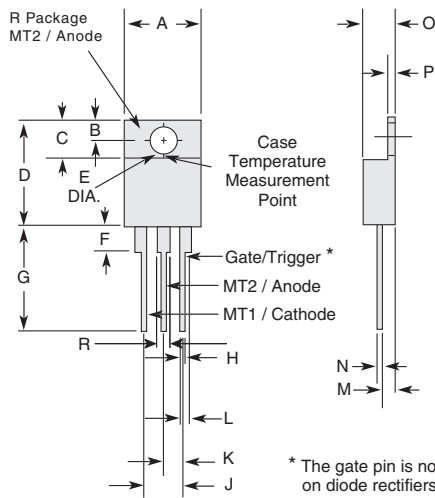

* The gate pin is not used on diode rectifiers.

Note: Maximum torque to be applied to mounting tab is 8 in-lbs. (0.904 Nm).

Dimension	Inches		Millimeters	
	MIN	MAX	MIN	MAX
A	0.380	0.420	9.65	10.67
B	0.105	0.115	2.66	2.92
C	0.230	0.250	5.85	6.35
D	0.590	0.620	14.98	15.75
E	0.142	0.147	3.61	3.73
F	0.110	0.130	2.80	3.30
G	0.540	0.575	13.71	14.60
H	0.025	0.035	0.63	0.89
J	0.195	0.205	4.95	5.21
K	0.095	0.105	2.41	2.67
L	0.060	0.075	1.52	1.91
M	0.070	0.085	1.78	2.16
N	0.018	0.024	0.45	0.61
O	0.178	0.188	4.52	4.78
P	0.045	0.060	1.14	1.53
R	0.038	0.048	0.97	1.22

P Package — TO-3 Fastpak
Isolated Mounting Base

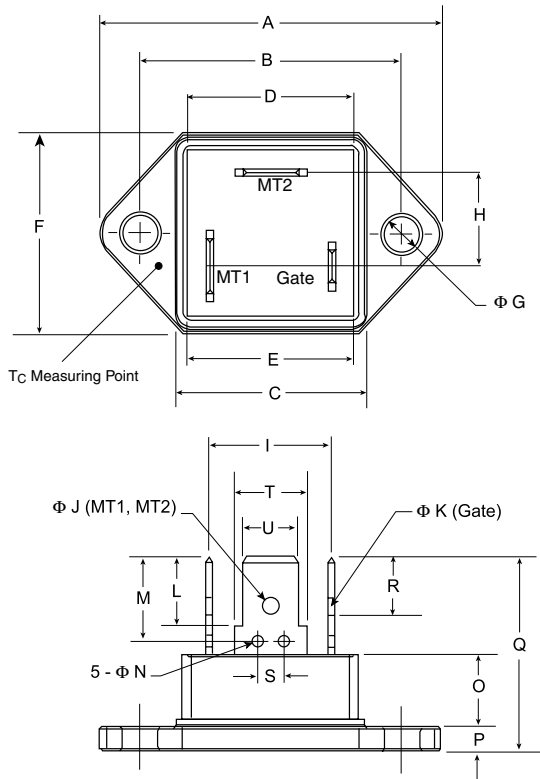

Dimension	Inches		Millimeters	
	MIN	MAX	MIN	MAX
A	1.531	1.543	38.90	39.20
B	1.177	1.185	29.90	30.10
C	0.843	0.850	21.40	21.60
D	0.780	0.795	19.80	20.20
E	0.783	0.791	19.90	20.10
F	0.874	0.906	22.20	23.00
G	0.161	0.169	4.10	4.30
H	0.386	0.465	9.80	11.80
I	0.508	0.587	12.90	14.90
J	0.079	0.087	2.00	2.20
K	0.047	0.055	1.20	1.40
L	0.307	0.319	7.80	8.10
M	0.372	0.396	9.45	10.05
N	0.043	0.059	1.10	1.50
O	0.315	0.331	8.00	8.40
P	0.098	0.106	2.50	2.70
Q	0.846	0.886	21.50	22.50
R	0.244	0.256	6.20	6.50
S	0.106	0.130	2.70	3.30
T (MT1)	0.321	0.329	8.15	8.35
T (MT2)	0.321	0.329	8.15	8.35
T (Gate)	0.220	0.228	5.60	5.80
U (MT1)	0.246	0.254	6.25	6.45
U (MT2)	0.246	0.254	6.25	6.45
U (Gate)	0.183	0.191	4.65	4.85
V	0.120	0.130	3.05	3.30
W	0.175	0.185	4.45	4.70

Note: Maximum torque to be applied to mounting tab is 8 in-lbs. (0.904 Nm).

E Package — TO-92

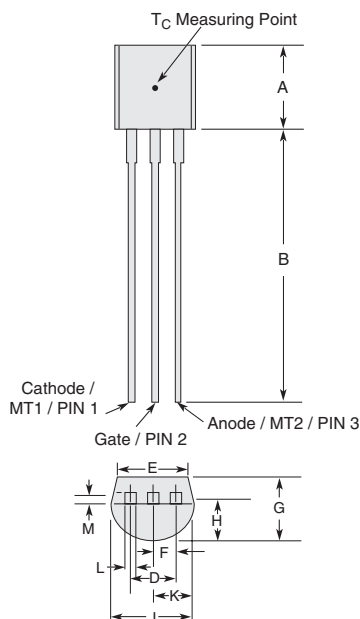

Dimension	Inches		Millimeters	
	MIN	MAX	MIN	MAX
A	0.176	0.196	4.47	4.98
B	0.500		12.70	
D	0.095	0.105	2.41	2.67
E	0.150		3.81	
F	0.046	0.054	1.16	1.37
G	0.135	0.145	3.43	3.68
H	0.088	0.096	2.23	2.44
J	0.176	0.186	4.47	4.73
K	0.088	0.096	2.23	2.44
L	0.013	0.019	0.33	0.48
M	0.013	0.017	0.33	0.43

All leads insulated from case. Case is electrically nonconductive.

S Package — DO-214AA

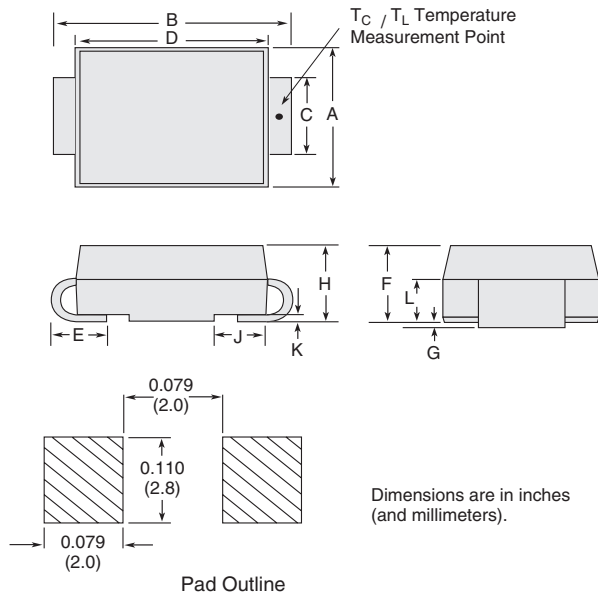

Dimension	Inches		Millimeters	
	MIN	MAX	MIN	MAX
A	0.140	0.155	3.56	3.94
B	0.205	0.220	5.21	5.59
C	0.077	0.083	1.96	2.11
D	0.166	0.180	4.22	4.57
E	0.036	0.056	0.91	1.42
F	0.073	0.083	1.85	2.11
G	0.004	0.008	0.10	0.20
H	0.077	0.086	1.96	2.18
J	0.043	0.053	1.09	1.35
K	0.008	0.012	0.20	0.30
L	0.027	0.049	0.69	1.24

M Package — TO-218AC

Non-Isolated Mounting Tab Common with Center Lead

K Package — TO-218AC

Isolated Mounting Tab

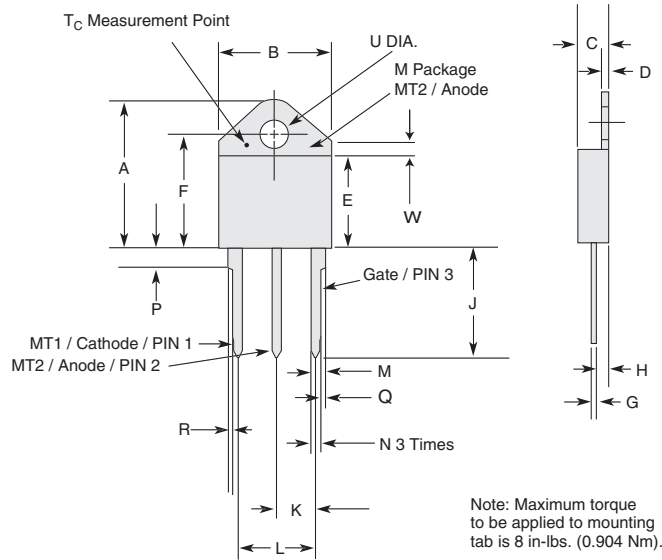

Dimension	Inches		Millimeters	
	MIN	MAX	MIN	MAX
A	0.810	0.835	20.57	21.21
B	0.610	0.630	15.49	16.00
C	0.178	0.188	4.52	4.78
D	0.055	0.070	1.40	1.78
E	0.487	0.497	12.37	12.62
F	0.635	0.655	16.13	16.64
G	0.022	0.029	0.56	0.74
H	0.075	0.095	1.91	2.41
J	0.575	0.625	14.61	15.88
K	0.211	0.219	5.36	5.56
L	0.422	0.437	10.72	11.10
M	0.058	0.068	1.47	1.73
N	0.045	0.055	1.14	1.40
P	0.095	0.115	2.41	2.92
Q	0.008	0.016	0.20	0.41
R	0.008	0.016	0.20	0.41
U	0.159	0.163	4.04	4.14
W	0.085	0.095	2.17	2.42

W Package — TO-218X
Non-isolated Mounting Tab Common with Center Lead

J Package — TO-218X
Isolated Mounting Tab

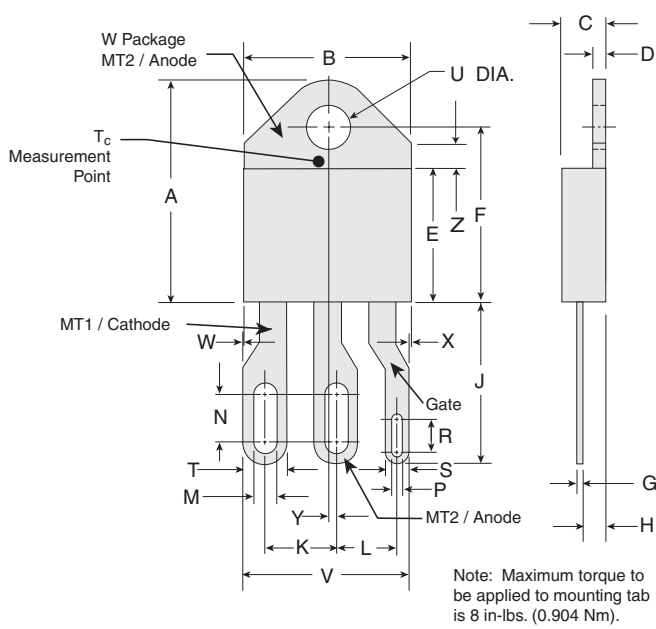

DIM	INCHES		MILLIMETERS	
	MIN	MAX	MIN	MAX
A	0.810	0.835	20.57	21.21
B	0.610	0.630	15.49	16.00
C	0.178	0.188	4.52	4.78
D	0.055	0.070	1.40	1.78
E	0.487	0.497	12.37	12.62
F	0.635	0.655	16.13	16.64
G	0.022	0.029	0.56	0.74
H	0.075	0.095	1.91	2.41
J	0.575	0.625	14.61	15.88
K	0.256	0.264	6.50	6.71
L	0.220	0.228	5.58	5.79
M	0.080	0.088	2.03	2.24
N	0.169	0.177	4.29	4.49
P	0.034	0.042	0.86	1.07
R	0.113	0.121	2.87	3.07
S	0.086	0.096	2.18	2.44
T	0.156	0.166	3.96	4.22
U	0.159	0.163	4.04	4.14
V	0.603	0.618	15.31	15.70
W	0.000	0.005	0.00	0.13
X	0.003	0.012	0.07	0.30
Y	0.028	0.032	0.71	0.81
Z	0.085	0.095	2.17	2.42

G Package — DO-15X
Axial Lead

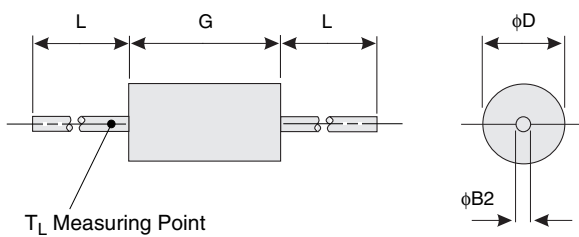

Dimension	Inches		Millimeters	
	MIN	MAX	MIN	MAX
$\phi B2$	0.027	0.035	0.686	0.889
ϕD	0.104	0.150	2.640	3.810
G	0.230	0.300	5.840	7.620
L	1.000		25.400	

C Package — Compak

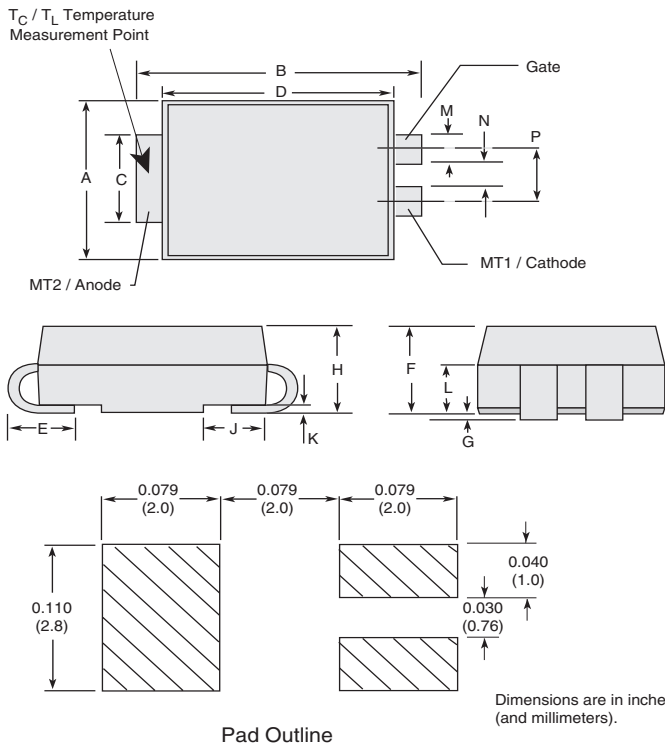

Dimension	Inches		Millimeters	
	MIN	MAX	MIN	MAX
A	0.140	0.155	3.56	3.94
B	0.205	0.220	5.21	5.59
C	0.077	0.083	1.96	2.11
D	0.166	0.180	4.22	4.57
E	0.036	0.056	0.91	1.42
F	0.073	0.083	1.85	2.11
G	0.004	0.008	0.10	0.20
H	0.077	0.086	1.96	2.18
J	0.043	0.053	1.09	1.35
K	0.008	0.012	0.20	0.30
L	0.027	0.049	0.69	1.24
M	0.022	0.028	1 0.56	0.71
N	0.027	0.033	0.69	0.84
P	0.052	0.058	1.32	1.47

N Package — TO-263 D²Pak Surface Mount

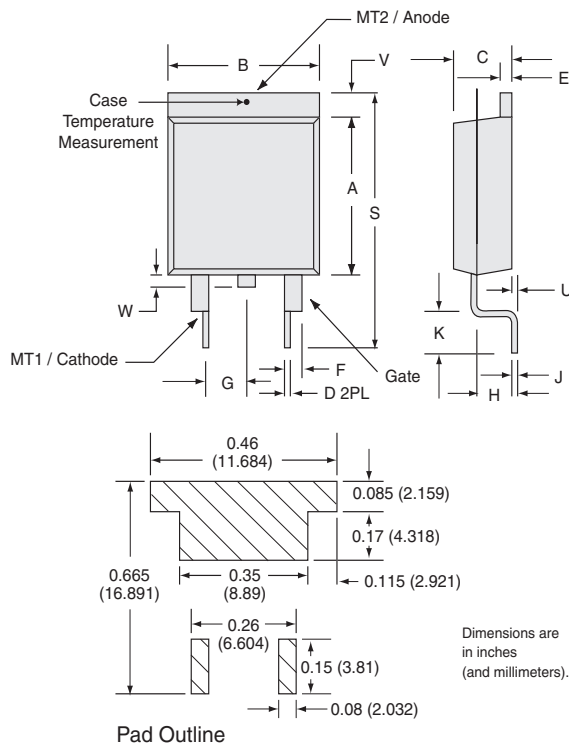

Dimension	Inches		Millimeters	
	MIN	MAX	MIN	MAX
A	0.360	0.370	9.14	9.40
B	0.380	0.420	9.65	10.67
C	0.178	0.188	4.52	4.78
D	0.025	0.035	0.63	0.89
E	0.048	0.055	1.22	1.40
F	0.060	0.075	1.52	1.91
G	0.095	0.105	2.41	2.67
H	0.083	0.093	2.11	2.36
J	0.018	0.024	0.46	0.61
K	0.090	0.110	2.29	2.79
S	0.590	0.625	14.99	15.87
V	0.035	0.045	0.89	1.14
U	0.002	0.010	0.05	0.25
W	0.040	0.070	1.02	1.78

D Package — TO-252AA
D-Pak Surface Mount

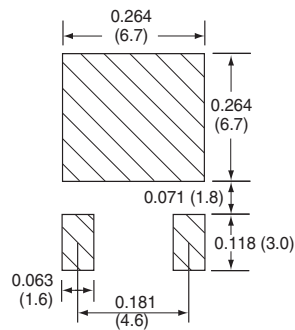
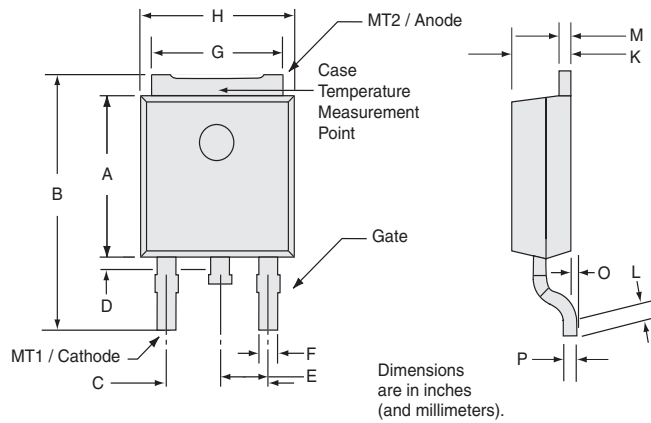

Pad Outline

Dimension	Inches		Millimeters	
	MIN	MAX	MIN	MAX
A	0.236	0.244	6.00	6.20
B	0.379	0.409	9.63	10.39
C	0.176	0.184	4.47	4.67
D	0.035	0.050	0.89	0.27
E	0.087	0.093	2.21	2.36
F	0.027	0.033	0.69	0.84
G	0.205	0.213	5.21	5.41
H	0.251	0.261	6.38	6.63
J	0.040	0.050	1.02	1.27
K	0.086	0.094	2.18	2.39
L	0.026	0.036	0.66	0.91
M	0.018	0.023	0.46	0.58
N	0.170	0.180	4.32	4.57
O	0.002	0.010	0.05	0.25
P	0.018	0.023	0.46	0.58

V Package — TO-251AA
V-Pak Through Hole

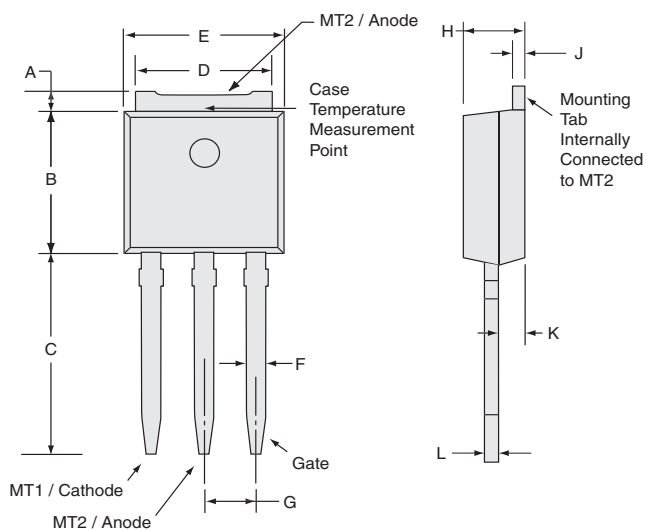

Dimension	Inches		Millimeters	
	MIN	MAX	MIN	MAX
A	0.040	0.050	1.02	1.27
B	0.236	0.244	6.00	6.20
C	0.350	0.375	8.89	9.53
D	0.205	0.213	5.21	5.41
E	0.251	0.261	6.38	6.63
F	0.027	0.033	0.69	0.84
G	0.087	0.093	2.21	2.36
H	0.086	0.094	2.18	2.39
J	0.018	0.023	0.46	0.58
K	0.036	0.042	0.91	1.07
L	0.018	0.023	0.46	0.58

Lead Form Dimensions

The TO-202AB, TO-220AB, and TO-92 package configurations, because of their unique design, can be mounted in a variety of methods, depending upon heat sink requirements and circuit packaging methods. Any of the derived types shown in this section are available as standard parts direct from the factory. Custom package variations are available. Consult the factory for more information.

To designate lead form options, simply indicate the type number at the end of the Teccor standard part number.

Example: Q2004F312 (Signifies Type 12)

Note: When ordering a TO-202 F package, include a 1 for standard full tab package. When ordering anything other than full tab, remove the 1 and add the Lead Form Type.

See "Description of Part Numbers" in the Product Selection Guide of this catalog for a complete description of Teccor part numbers.

Lead Bending Specifications

Leads may be bent easily and may be bent to any desired angle, provided that the bend is made at a minimum 0.063" (0.1 for TO-218) away from the package body with a minimum radius of 0.032". DO-15X device leads may be bent with a minimum radius of 0.050", and DO-35 device leads may be bent with a minimum radius of 0.028". Leads should be held firmly between the package body and the bend, so that strain on the leads is not transmitted to the package body.

When bending leads in the plane of the leads (spreading), bend only the narrow part.

Sharp angle bends should be done only once, as repetitive bending will fatigue and break the leads.

TO-202AB Type 11 — F Package

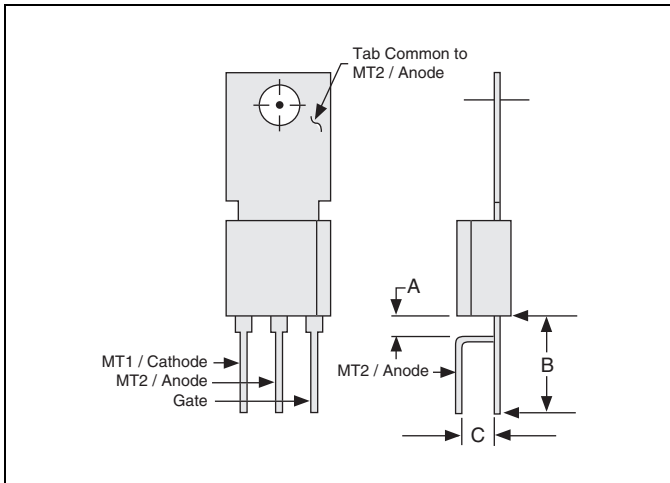

Dimension	Inches		Millimeters	
	MIN	MAX	MIN	MAX
A	0.080	0.120	2.03	3.05
B	0.301	0.361	7.65	9.17
C	0.080	0.120	2.03	3.05

TO-202AB Type 2 — F Package

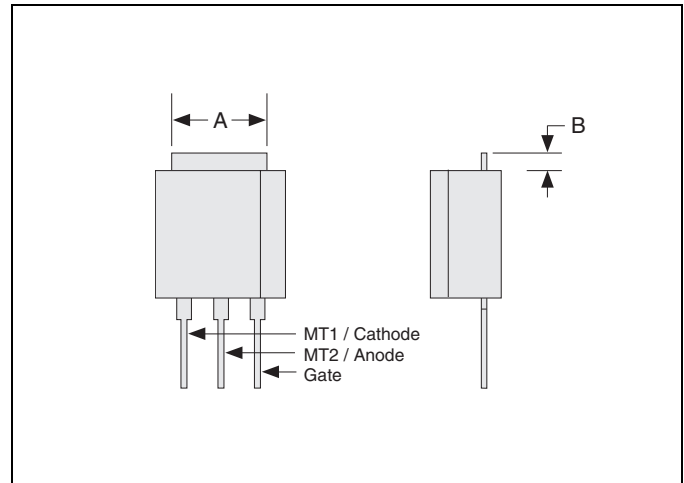

Dimension	Inches		Millimeters	
	MIN	MAX	MIN	MAX
A	0.240	0.260	6.100	6.60
B	0.030	0.050	0.762	1.27

TO-202AB Type 12 — F Package

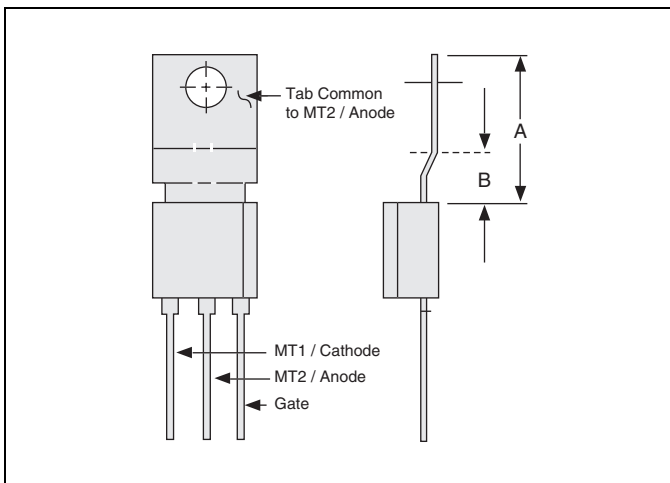

Dimension	Inches		Millimeters	
	MIN	MAX	MIN	MAX
A	0.435	0.495	11.05	12.57
B	0.120	0.160	3.05	4.06

TO-202AB Type 21 — F Package

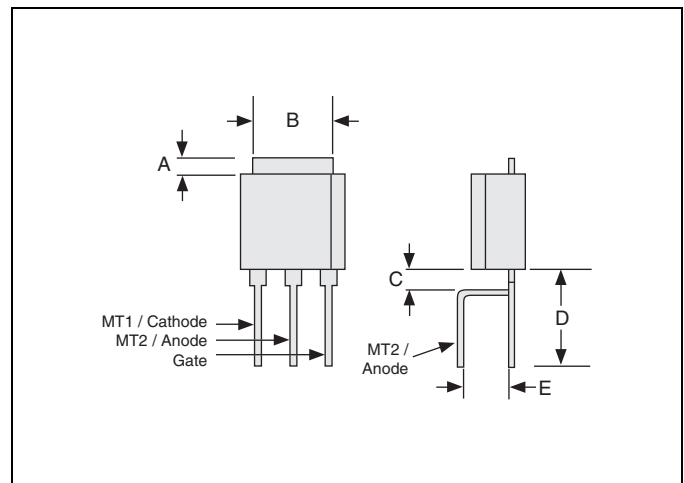

Dimension	Inches		Millimeters	
	MIN	MAX	MIN	MAX
A	0.030	0.050	0.762	1.27
B	0.240	0.260	6.100	6.60
C	0.080	0.120	2.030	3.05
D	0.301	0.361	7.650	9.17
E	0.080	0.120	2.030	3.05

TO-202AB Type 23 — F Package

Sidac Only

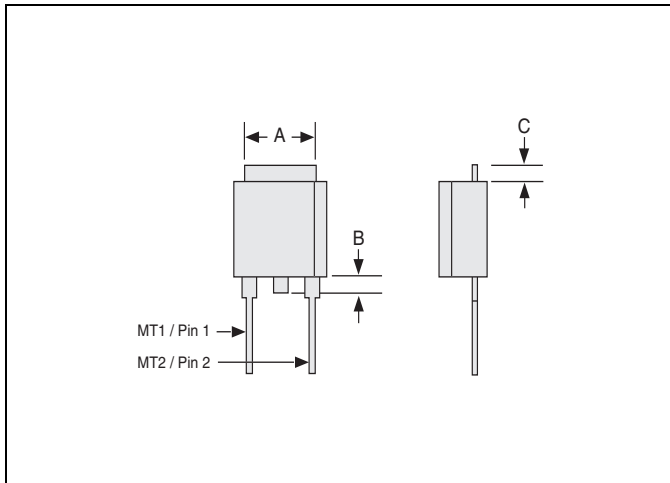

Dimension	Inches		Millimeters	
	MIN	MAX	MIN	MAX
A	0.240	0.260	6.100	6.60
B	0.030	0.050	0.762	1.27
C	0.030	0.050	0.762	1.27

TO-202AB Type 3 — F Package

Non-isolated

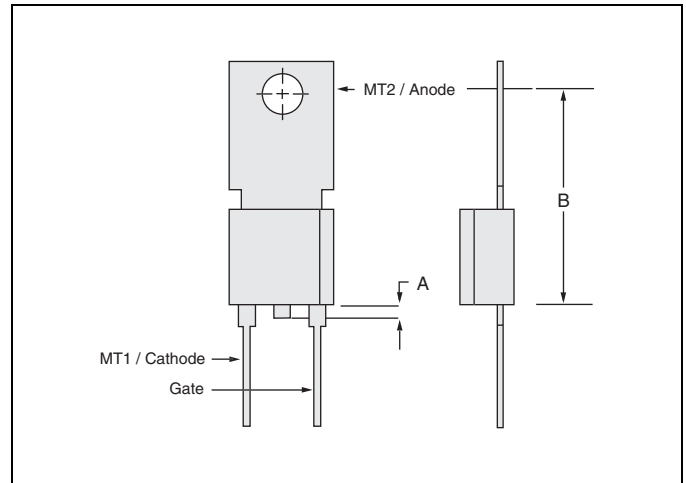

Dimension	Inches		Millimeters	
	MIN	MAX	MIN	MAX
A	0.030	0.050	0.762	1.27
B	0.645	0.705	16.380	17.91

TO-202AB Type 26 — F Package

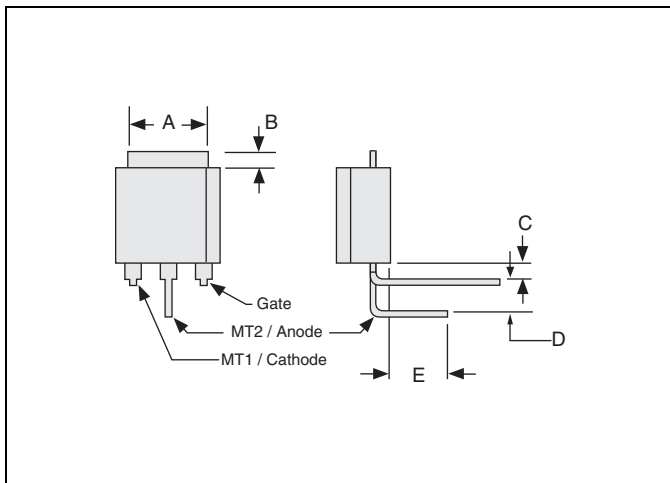

Dimension	Inches		Millimeters	
	MIN	MAX	MIN	MAX
A	0.240	0.260	6.100	6.60
B	0.030	0.050	0.762	1.27
C	0.050	0.070	0.127	1.78
D	0.095	0.105	2.410	2.67
E	0.172	0.202	4.370	5.13

TO-202AB Type 32 — F Package

Non-isolated

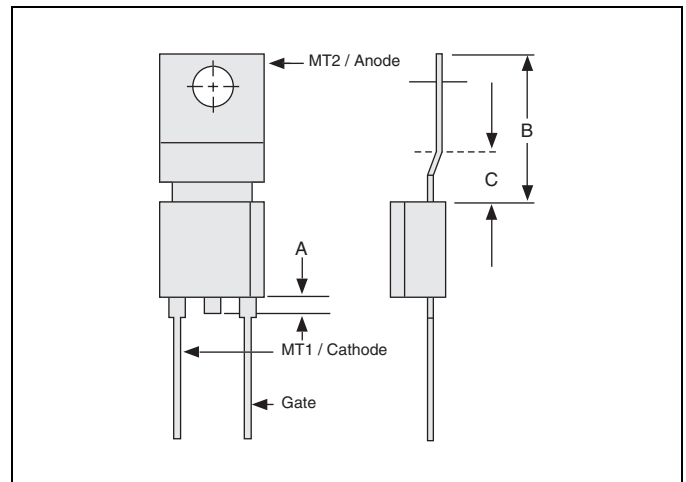

Dimension	Inches		Millimeters	
	MIN	MAX	MIN	MAX
A	0.030	0.050	0.762	1.27
B	0.435	0.495	11.050	12.57
C	0.120	0.160	3.050	4.06

TO-202AB Type 4 — F Package

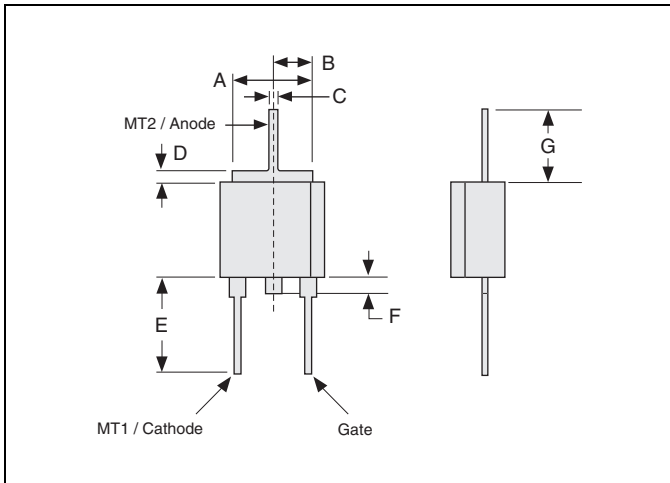

Dimension	Inches		Millimeters	
	MIN	MAX	MIN	MAX
A	0.240	0.260	6.100	6.600
B	0.114	0.134	2.900	3.400
C	0.023	0.029	0.584	0.737
D	0.030	0.050	0.762	1.270
E	0.297	0.327	7.540	8.310
F	0.030	0.050	0.765	1.270
G	0.297	0.327	7.540	8.310

TO-202AB Type 43 — F Package

Surface Mount

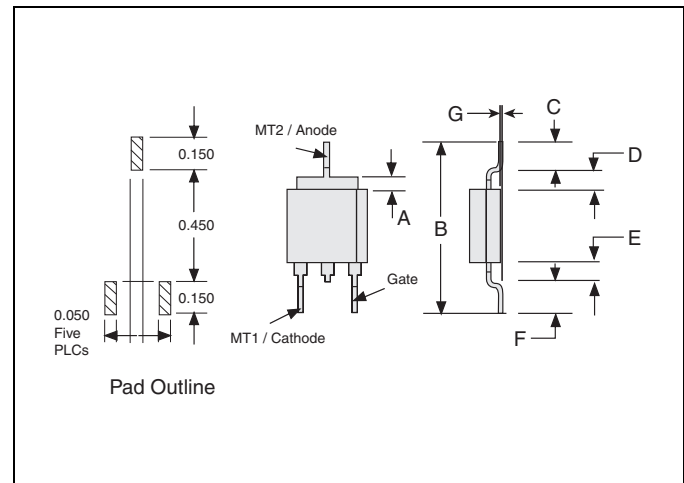

Dimension	Inches		Millimeters	
	MIN	MAX	MIN	MAX
A	0.030	0.050	0.762	1.270
B	0.680	0.760	17.270	19.300
C	0.110	0.130	2.800	3.300
D	0.080	0.100	2.030	2.540
E	0.080	0.100	2.030	2.540
F	0.110	0.130	2.800	3.300
G	0.000	0.013	0.000	0.330

TO-202AB Type 41 — F Package

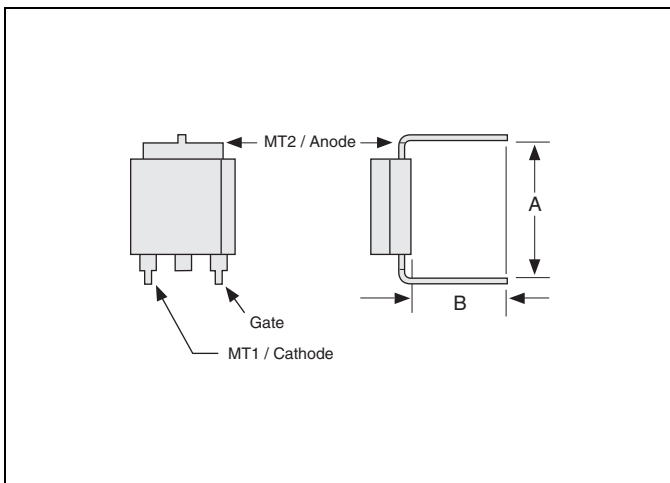

Dimension	Inches		Millimeters	
	MIN	MAX	MIN	MAX
A	0.380	0.420	9.65	10.67
B	0.180	0.220	4.57	5.59

TO-220 Type 51 — R or L Package

Replaces RCA 6249

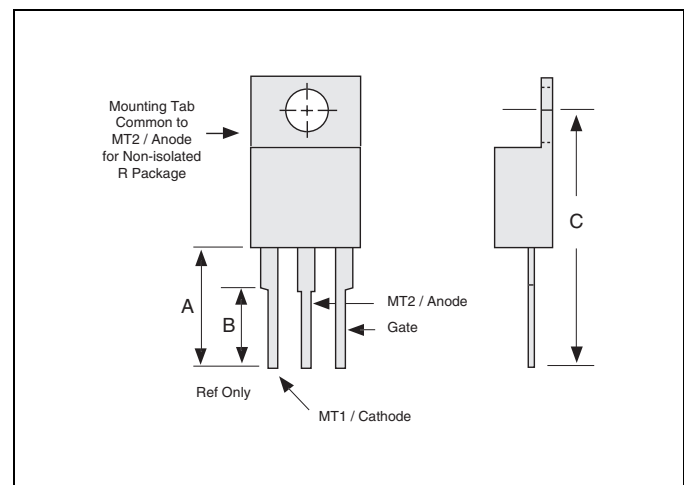

Dimension	Inches		Millimeters	
	MIN	MAX	MIN	MAX
A	0.320	0.340	8.13	8.64
B	0.190		4.83	
C	0.795	0.850	20.19	21.59

TO-220 Type 52 — R or L Package

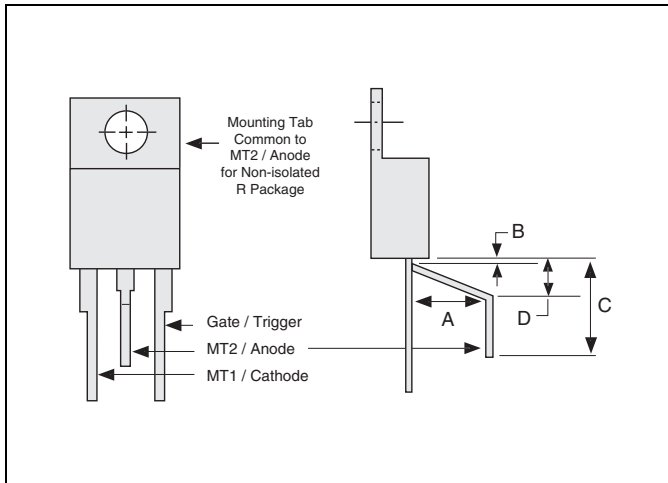

Dimension	Inches		Millimeters	
	MIN	MAX	MIN	MAX
A	0.169	0.189	4.29	4.80
B	0.040	0.060	1.02	1.52
C	0.250		6.35	
D	0.110	0.170	2.79	4.32

TO-220 Type 54 — R Package

Replaces Motorola Form 4, G.E. Type 4, RCA 6206

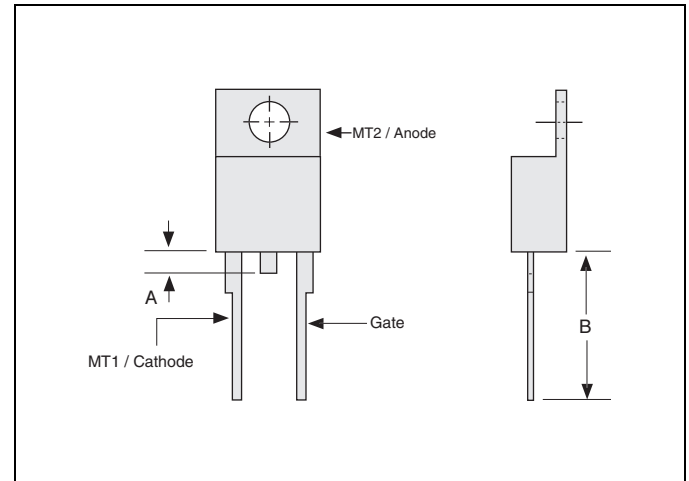

Dimension	Inches		Millimeters	
	MIN	MAX	MIN	MAX
A	0.040	0.070	1.02	1.78
B	0.500		12.70	

TO-220 Type 53 — R or L Package

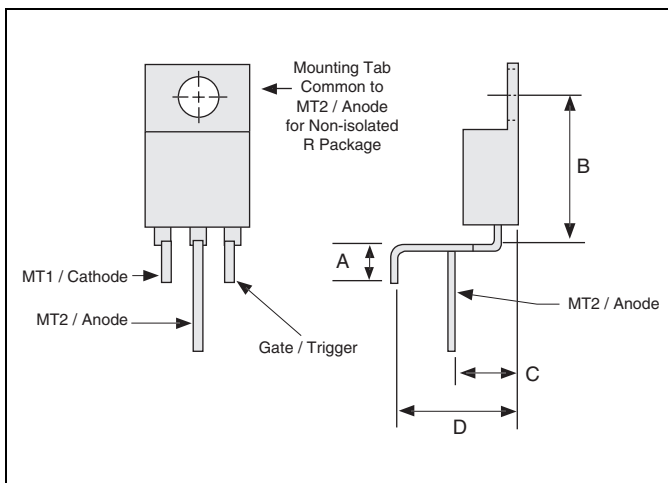

Dimension	Inches		Millimeters	
	MIN	MAX	MIN	MAX
A	0.175		4.45	
B	0.542	0.582	13.77	14.78
C	0.167	0.207	4.24	5.26
D	0.355	0.395	9.02	10.03

TO-220 Type 55 — R or L Package

Replaces G.E. Type 5

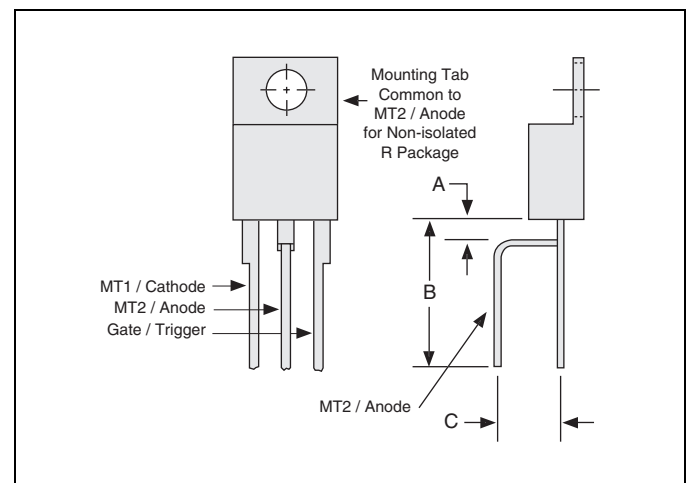

Dimension	Inches		Millimeters	
	MIN	MAX	MIN	MAX
A	0.065	0.095	1.65	2.41
B	0.353	0.433	8.97	11.00
C	0.115	0.130	2.92	3.30

TO-220 Type 56 — R or L Package

Replaces G.E. Type 6, Motorola Lead Form 3, RCA 6221

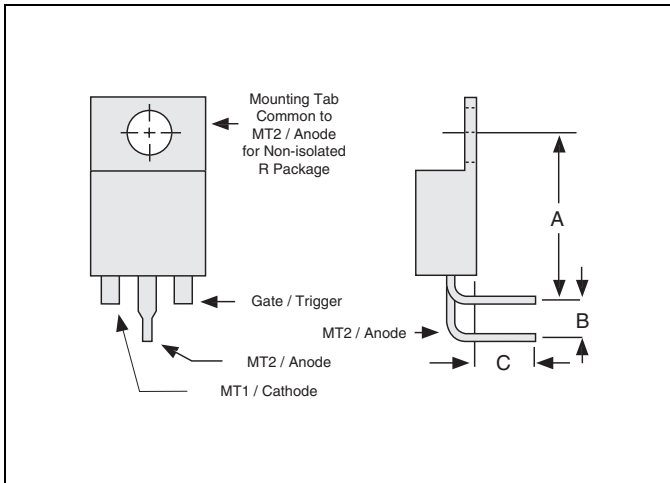

Dimension	Inches		Millimeters	
	MIN	MAX	MIN	MAX
A	0.570	0.590	14.48	14.99
B	0.120	0.130	3.05	3.30
C	0.172	0.202	4.37	5.13

TO-220 Type 58 — R or L Package

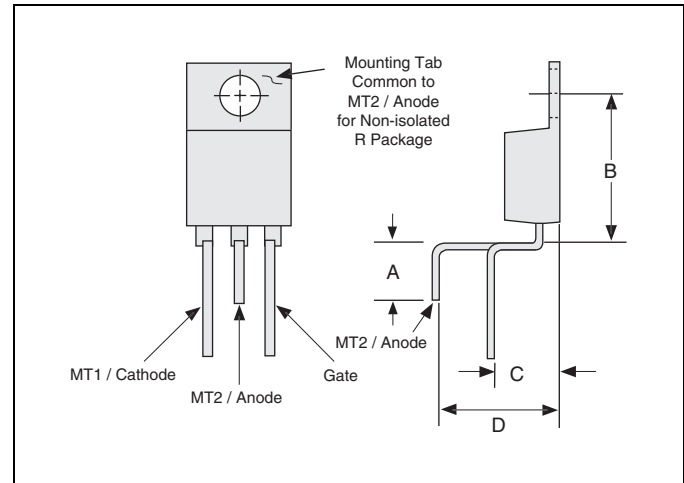

Dimension	Inches		Millimeters	
	MIN	MAX	MIN	MAX
A	0.175		4.45	
B	0.542	0.582	13.77	14.78
C	0.167	0.207	4.24	5.26
D	0.355	0.395	9.02	10.03

TO-220 Type 57 — R Package

Similar to TO-66, Gate-Cathode Reversed

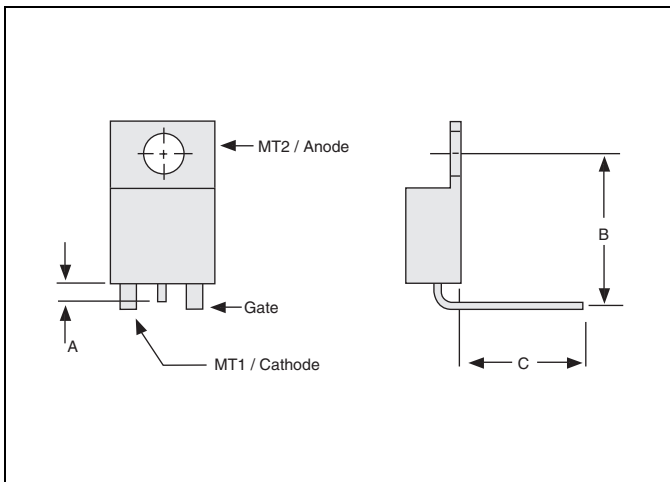

Dimension	Inches		Millimeters	
	MIN	MAX	MIN	MAX
A	0.040	0.070	1.02	1.78
B	0.570	0.590	14.48	14.99
C	0.340	0.422	8.64	10.72

TO-220 Type 59 — R or L Package

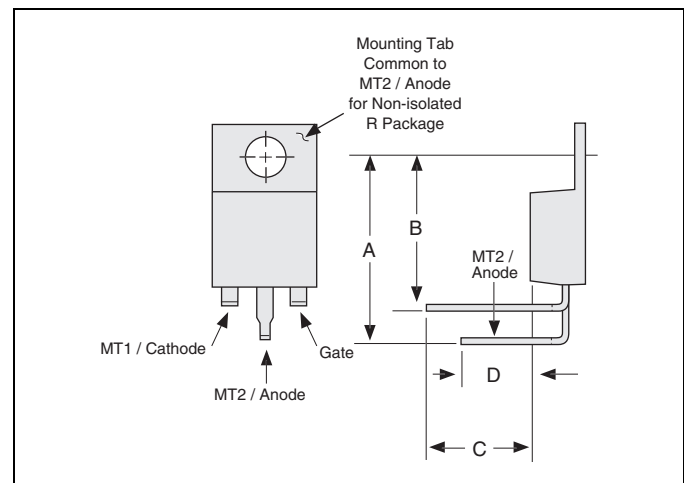

Dimension	Inches		Millimeters	
	MIN	MAX	MIN	MAX
A	0.685	0.725	17.40	18.42
B	0.558	0.598	14.17	15.19
C	0.375		9.53	
D	0.250		6.35	

TO-220 Type 65 — R or L Package

Replaces RCA 6210

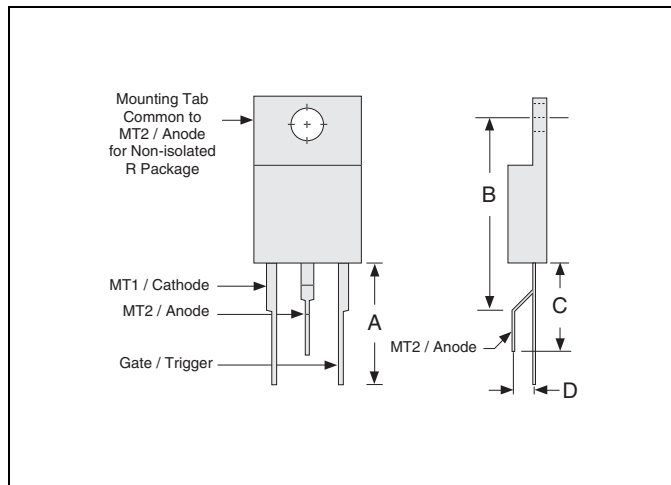

Dimension	Inches		Millimeters	
	MIN	MAX	MIN	MAX
A	0.550	0.580	12.70	14.27
B	0.820	0.260	14.73	15.75
C	0.530	0.570	7.62	
D	0.080	0.120	2.03	3.05

TO-220 Type 68 — R or L Package

Surface Mount

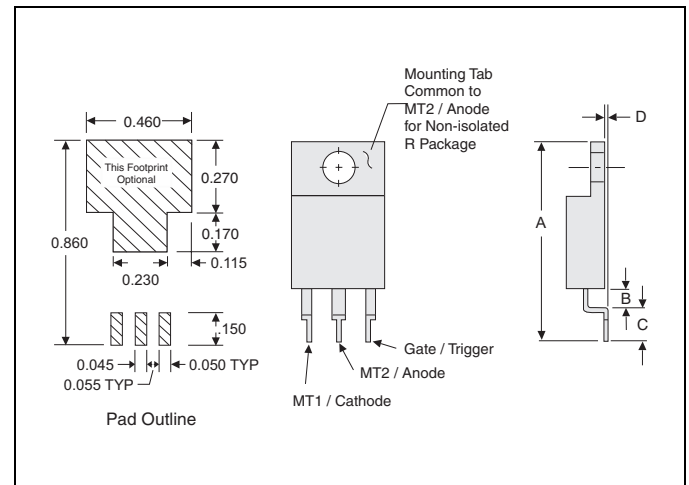

Dimension	Inches		Millimeters	
	MIN	MAX	MIN	MAX
A	0.780	0.850	19.05	21.59
B	0.080	0.100	2.03	2.54
C	0.110	0.130	2.79	3.30
D		0.013		0.33

TO-220 Type 67 — R Package

Surface Mount

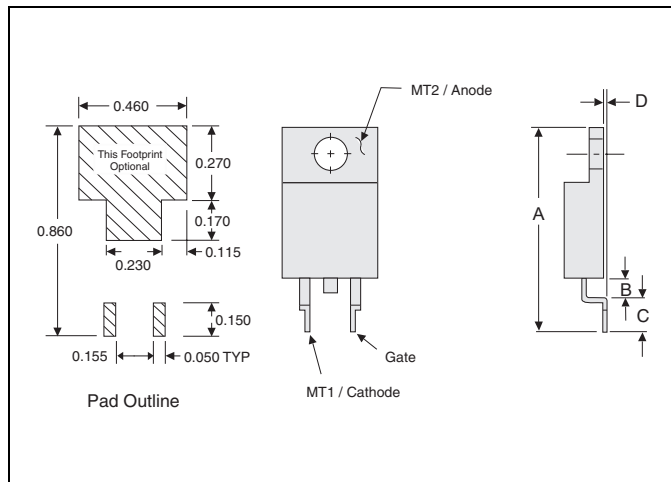

Dimension	Inches		Millimeters	
	MIN	MAX	MIN	MAX
A	0.780	0.850	19.05	21.59
B	0.080	0.100	2.03	2.54
C	0.110	0.130	2.79	3.30
D		0.013		0.33

TO-92 Type 70 — E Package

Sidac Only

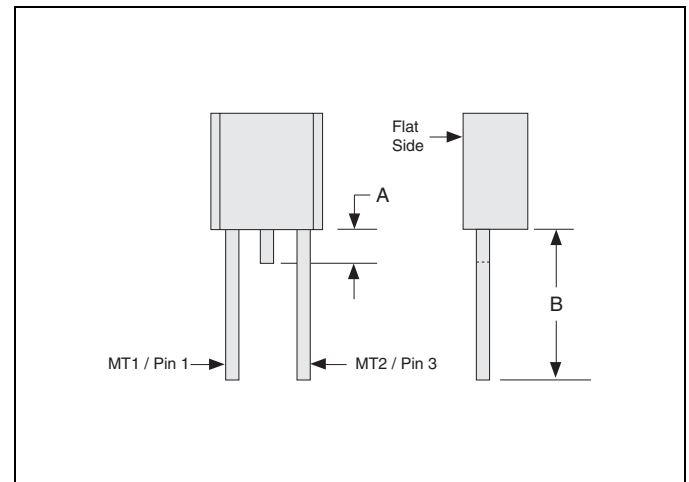

Dimension	Inches		Millimeters	
	MIN	MAX	MIN	MAX
A		0.060		1.52
B	0.50		12.7	

TO-92 Type 73 — E Package

Surface Mount

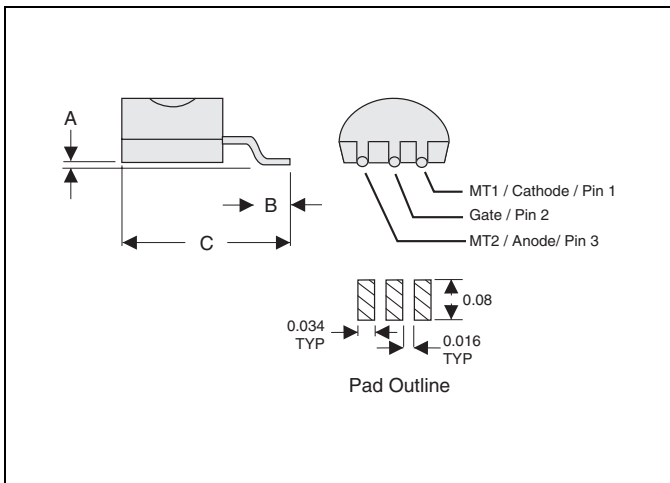

Dimension	Inches		Millimeters	
	MIN	MAX	MIN	MAX
A	0.000	0.010	0.000	0.254
B	0.052	0.067	1.320	1.700
C	0.295	0.315	7.490	8.000

TO-218 Type 81 — K, M, J, or W Packages

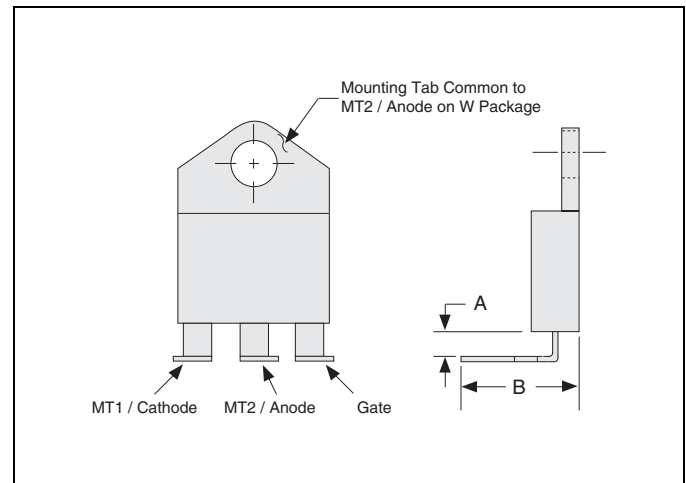

Dimension	Inches		Millimeters	
	MIN	MAX	MIN	MAX
A	0.080	0.120	2.03	3.05
B	0.580	0.640	14.73	16.26

TO-92 Type 75 — E Package

Replaces TO-5 Pinout

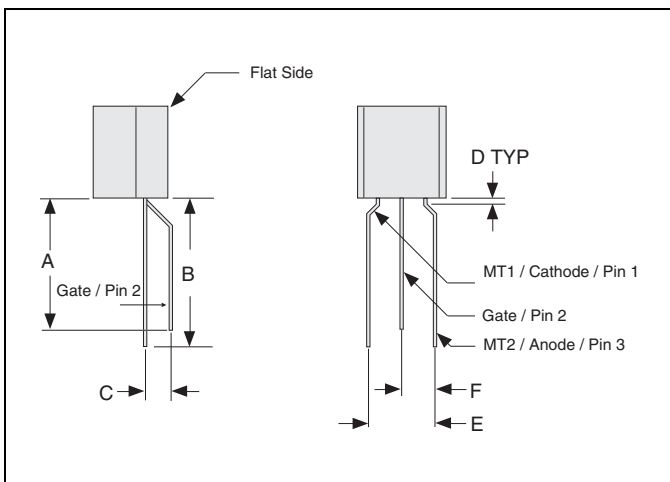

Dimension	Inches		Millimeters	
	MIN	MAX	MIN	MAX
A	0.400		10.16	
B	0.500		12.70	
C	0.080	0.120	2.03	3.05
D	0.045	0.085	1.14	2.16
E	0.180	0.220	4.57	5.59
F	0.080	0.120	2.03	3.05

TO-218 Type 82 — M and W Packages

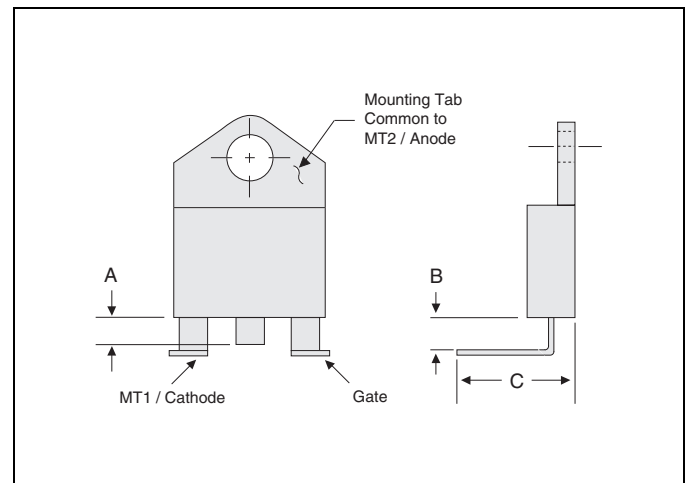

Dimension	Inches		Millimeters	
	MIN	MAX	MIN	MAX
A		0.095		2.41
B	0.080	0.120	2.03	3.05
C	0.580	0.640	14.73	16.26

DO-35 Type 91 — Y Package

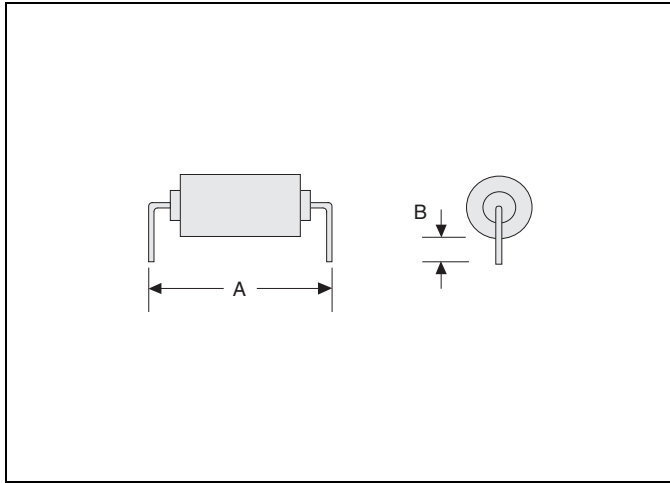

Dimension	Inches		Millimeters	
	MIN	MAX	MIN	MAX
A	0.519	0.521	12.18	13.23
B	0.140	0.172	3.56	4.37

DO-35 Type 92 — Y Package

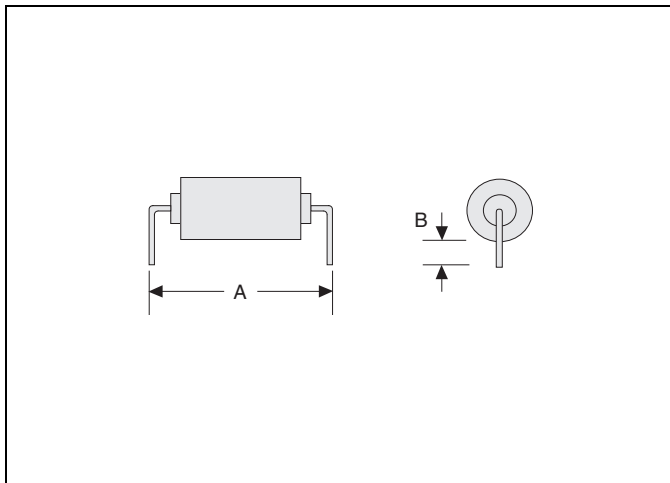

Dimension	Inches		Millimeters	
	MIN	MAX	MIN	MAX
A	0.610	0.630	15.49	16.00
B	0.140	0.172	3.56	4.37

DO-35 Type 93 — Y Package

Surface Mount

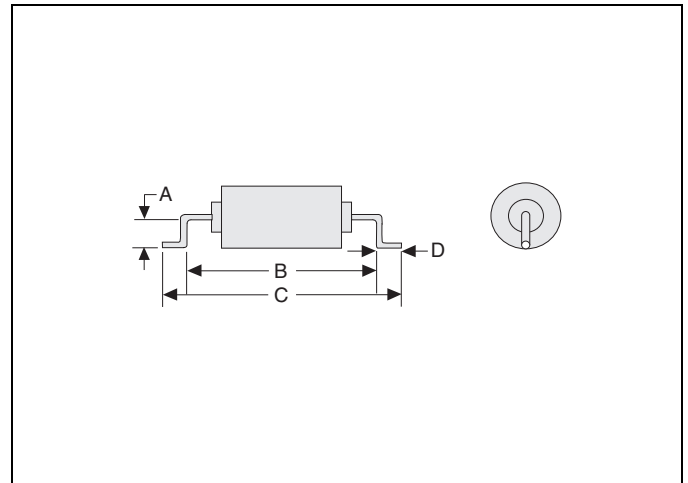

Dimension	Inches		Millimeters	
	MIN	MAX	MIN	MAX
A	0.020	0.060	0.508	1.52
B	0.290	0.310	7.370	7.87
C	0.370	0.430	9.400	10.92
D	0.040	0.060	1.020	1.52

Packing Options

Packing options include:













- Bulk Pack
- Reel Pack (RP)
- Ammo Pack (AP)
- Tube Pack (TP)
- Embossed Carrier (RP)

See "Package Type and Packing Options" on page M3-2.

Sample Instructions for Choosing a Packing Option

- (1) If selecting an "L401E6" (sensitive gate, 400 V, 1 A triac in a TO-92 package), choose one of the options available for that device:
 - Bulk packed in 2,000 quantity
 - Tape and Reel with 2,000 parts per reel
 - Tape and Ammo with 2,000 parts per box
- (2) Add the designated code as a suffix to the device number, such as "L401E6 RP" if selecting Tape and Reel or "L401E6 AP" if selecting Tape and Ammo. (Bulk packing requires no suffix.)

Package Type and Packing Options

Package Type	Package Code	Packing Options				
		Bulk Pack	Reel Pack (RP)	Ammo Pack (AP)	Tube Pack (TP)	Embossed Carrier (RP)
TO-92 	E	2,000	2,000	2,000	Contact factory for availability	Only Type 73
TO-220 	L, R	500	n/a	n/a	50	Only Type 67 and 68
TO-202 	F	500	700 (Type 2)	n/a	50	Only Type 43
TO-218 	K, J, M, W	250	n/a	n/a	Contact factory for availability	n/a
Fastpak 	P	200	n/a	n/a	n/a	n/a
TO-251 V-Pak 	V	1,000	Contact factory for availability	n/a	75	n/a
TO-252 D-Pak 	D	n/a	n/a	n/a	75	2500
TO-263 D ² Pak 	N	n/a	n/a	n/a	50	500
DO-214 	S	1,000	n/a	n/a	n/a	2500
Compak 	C	1,000	n/a	n/a	n/a	2500
DO-35 	Y	10,000 Minimum order of 5,000 available	5,000	n/a	n/a	n/a
DO-15X 	G	1,000	5,000	n/a	n/a	n/a

TO-92 (3-lead) Reel Pack (RP) Radial Leded

Meets all EIA-468-B 1994 Standards

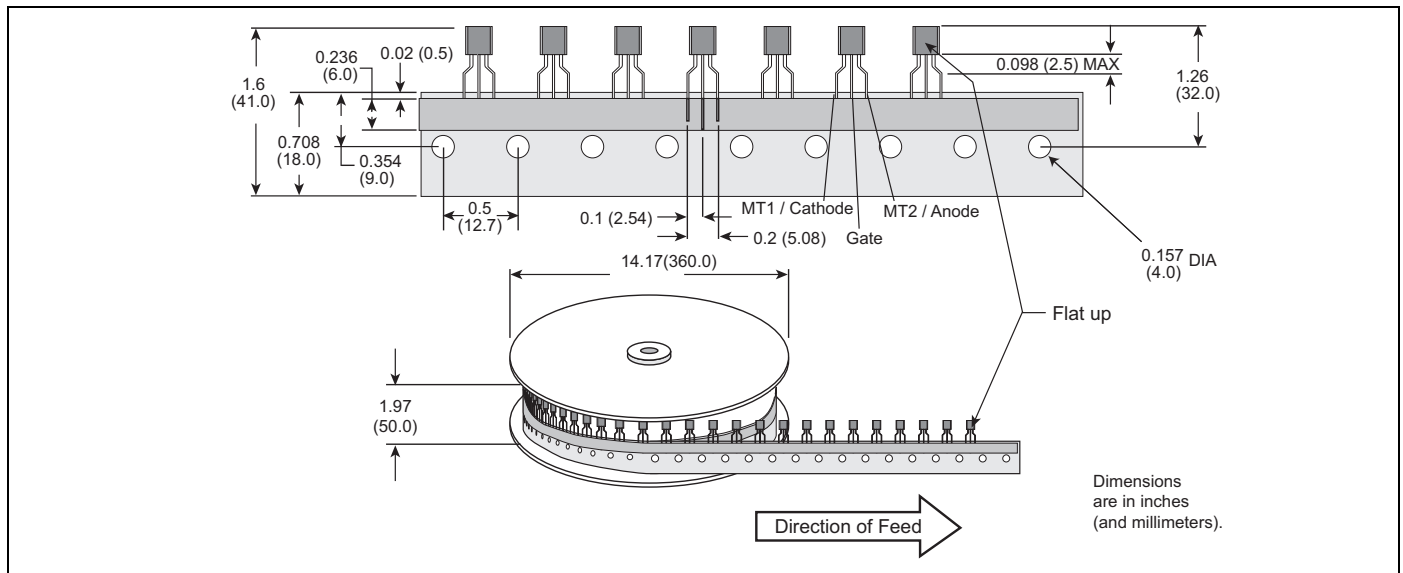

TO-92 (3-lead) Ammo Pack (AP) Radial Leded

Meets all EIA-468-B 1994 Standards

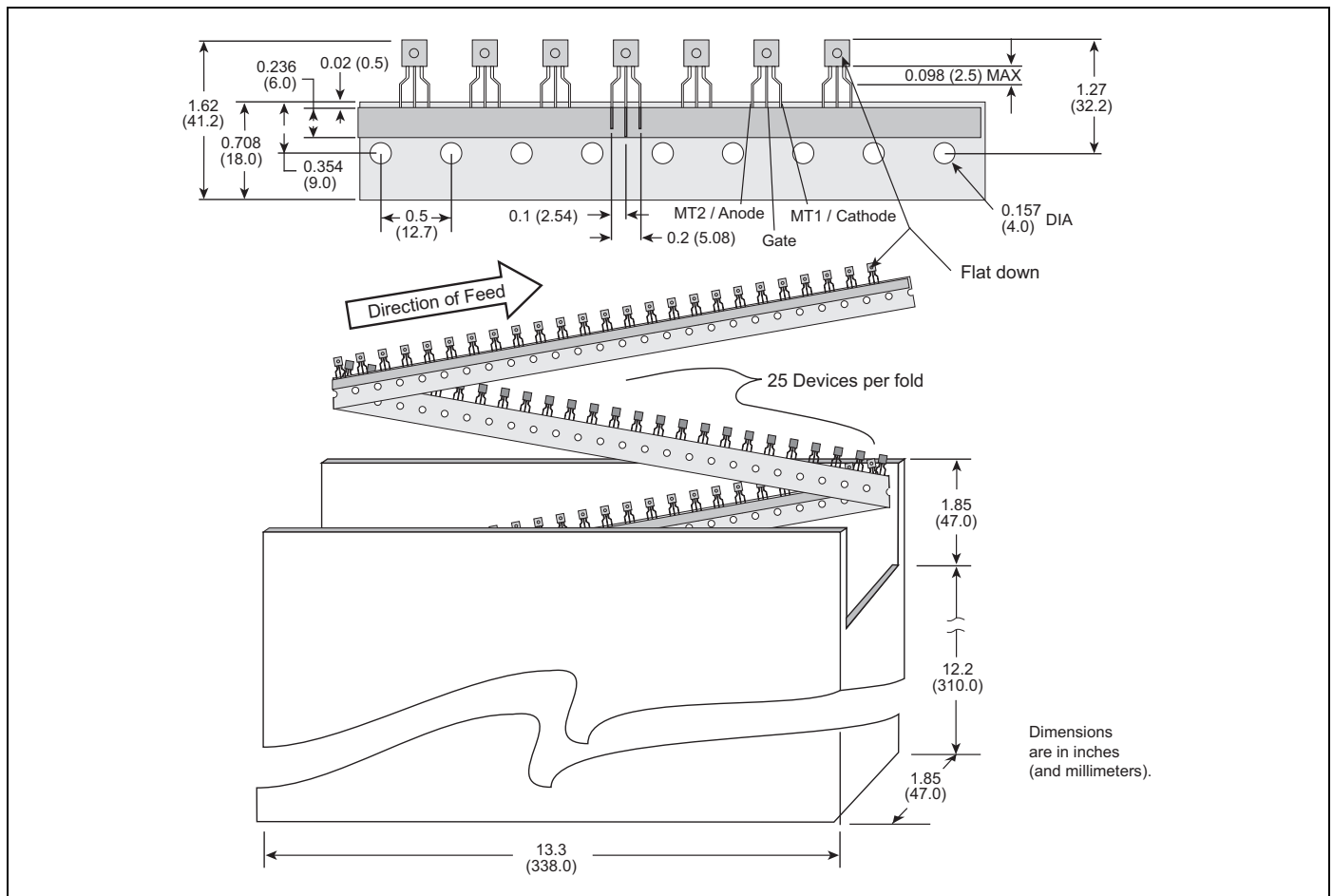

TO-92 Type 70 Reel Pack (RP3) Optional

Meets all EIA-468-B 1994 Standards

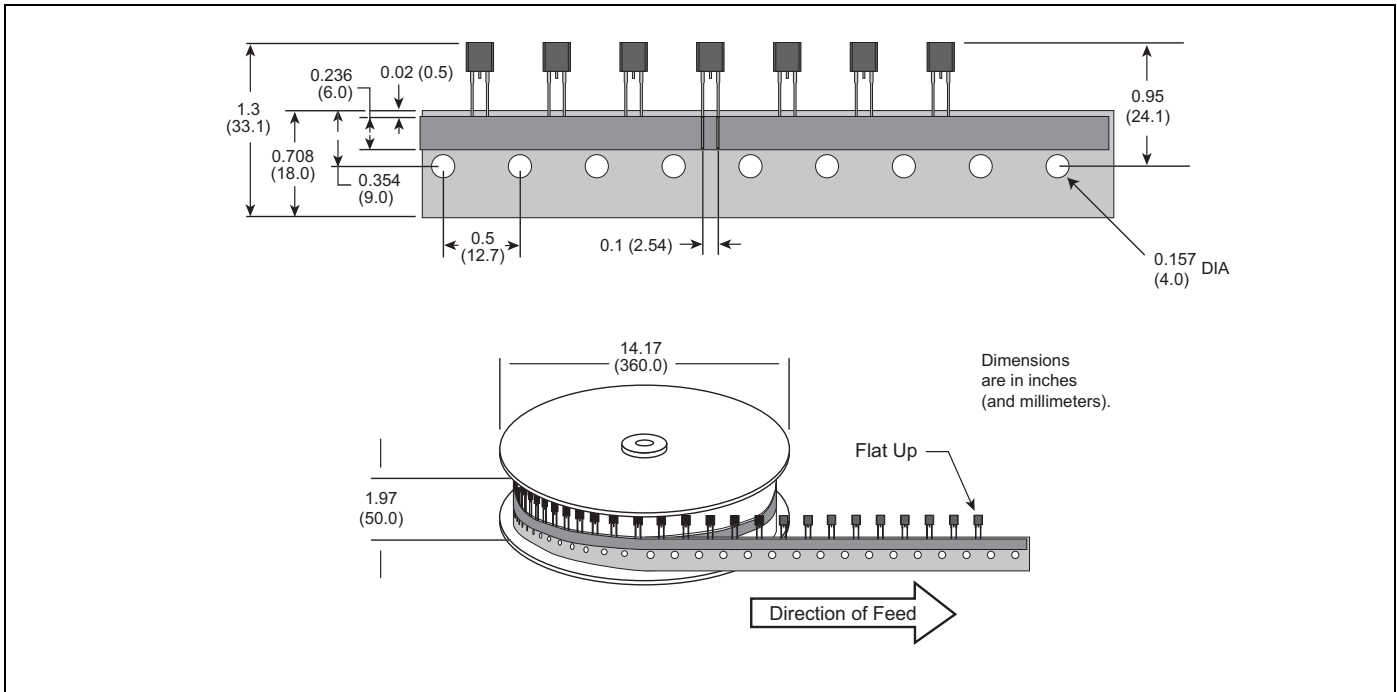

TO-92 Type 70 Reel Pack (RP2) Standard

Meets all EIA-468-B 1994 Standards

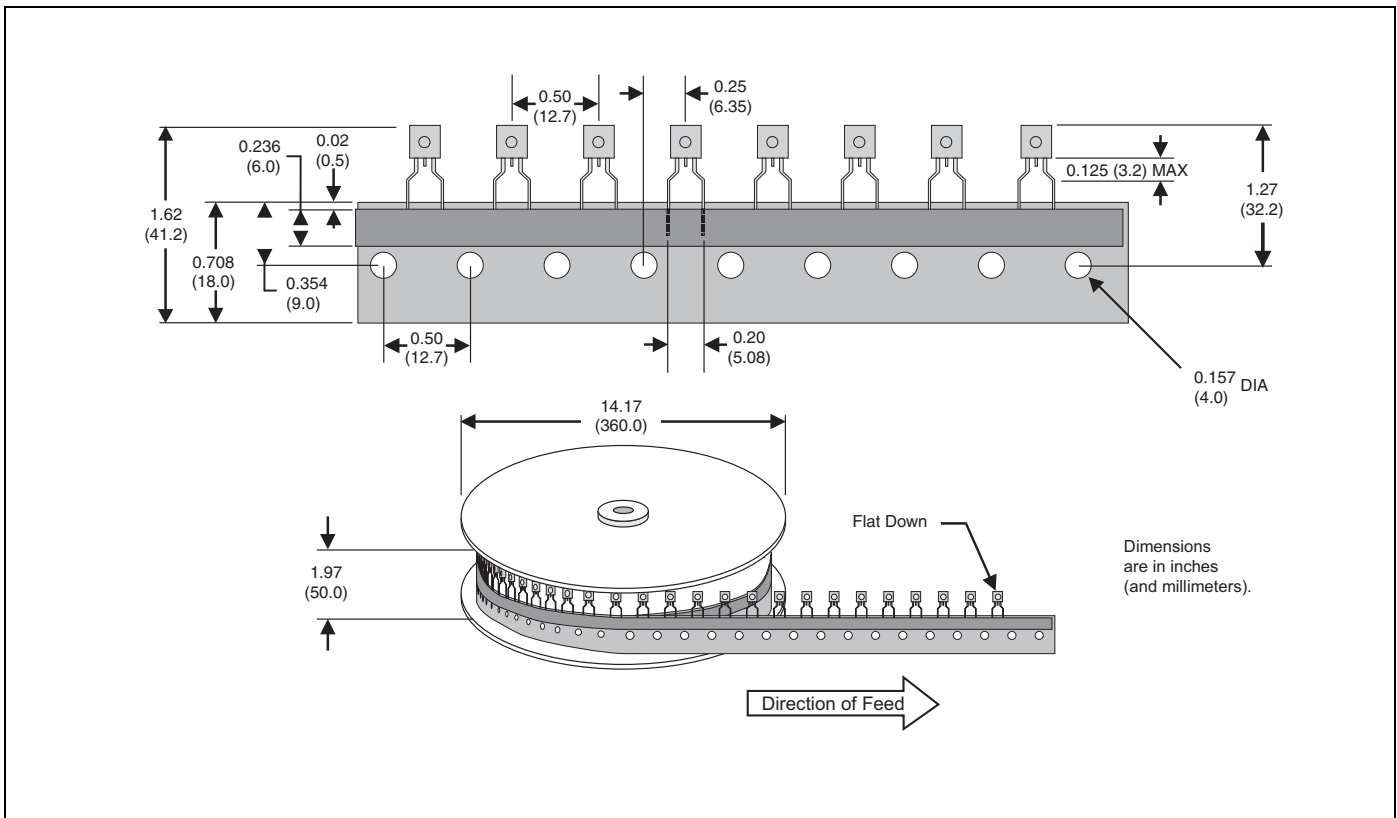

TO-92 Type 70 Ammo Pack (AP) Radial Leaded

Meets all EIA-468-B 1994 Standards

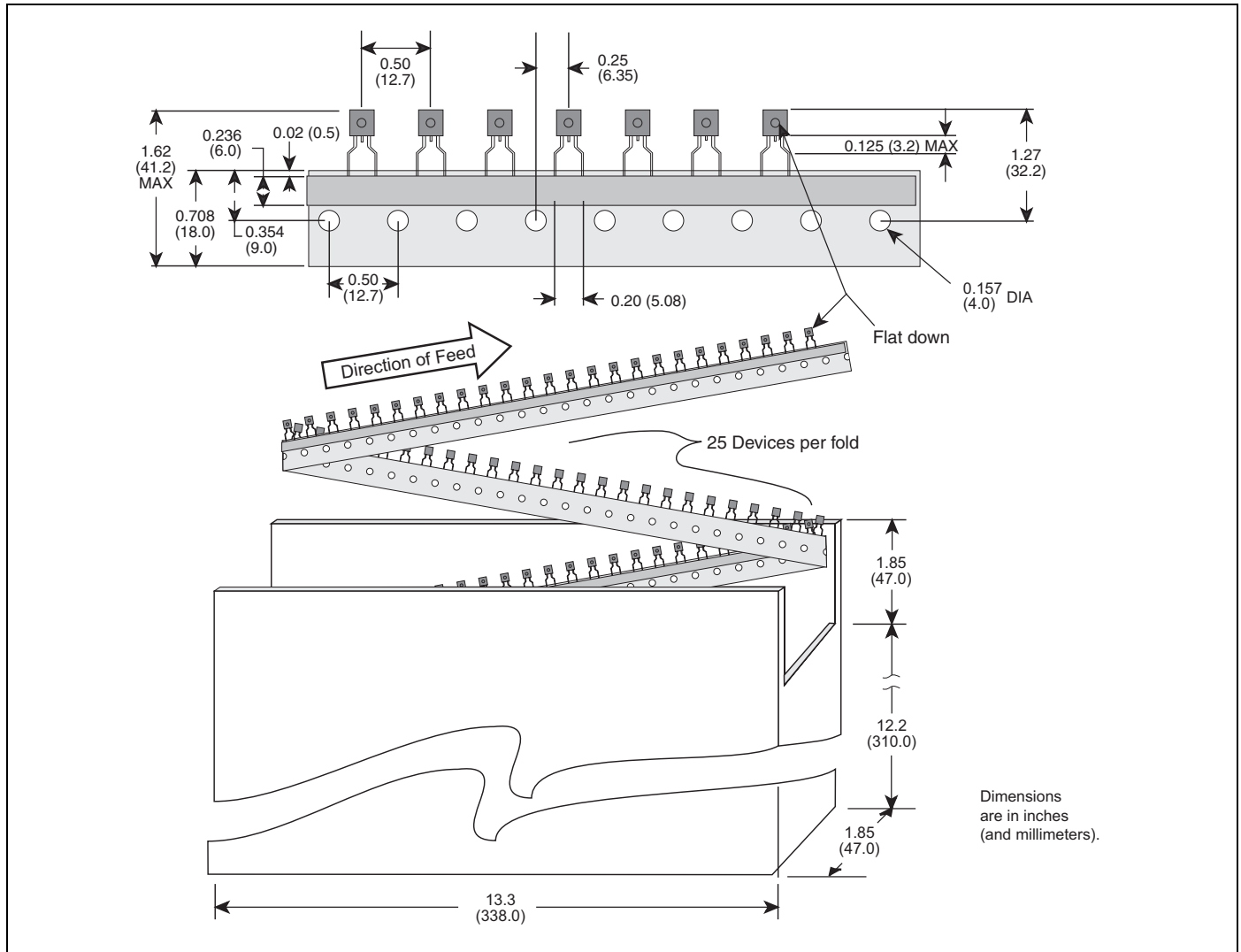

TO-202 Type 2 Reel Pack (RP)

Meets all EIA-468-B 1994 Standards

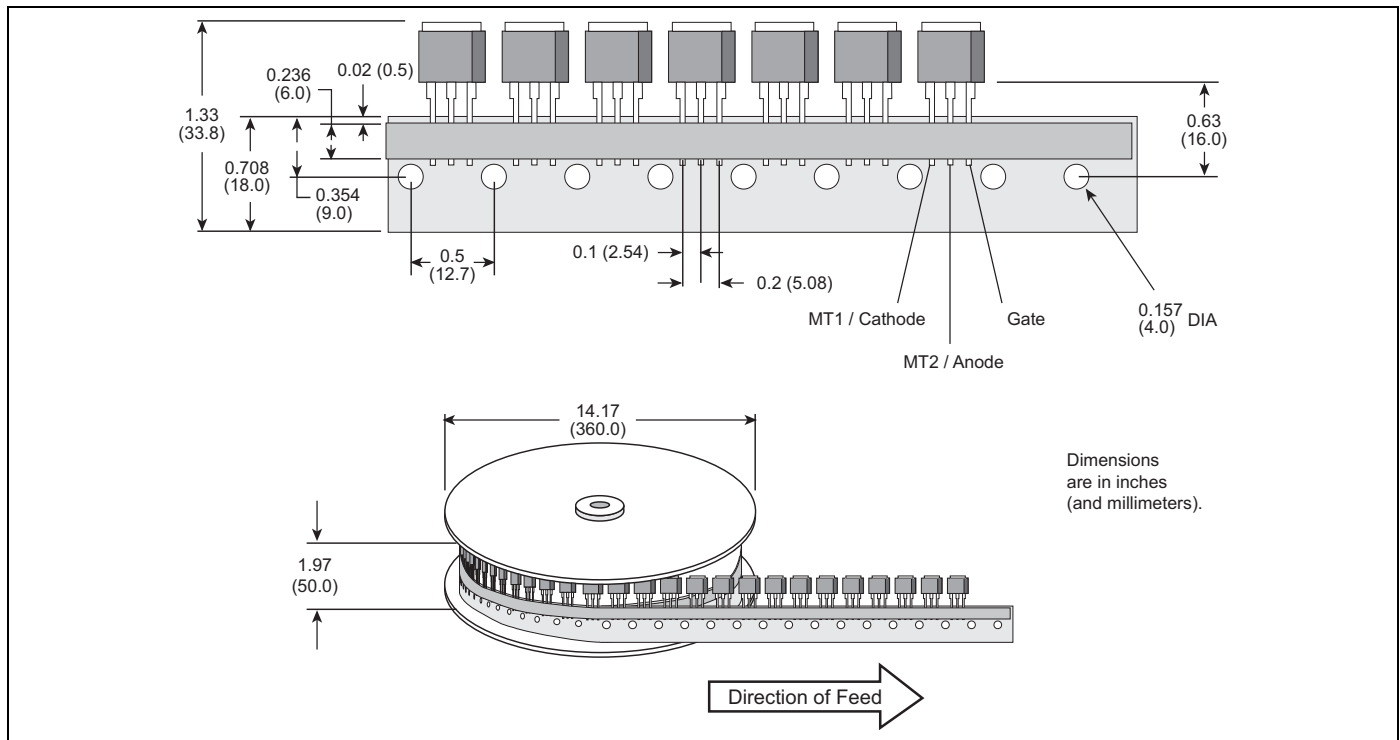

Reel Pack (RP) for TO-252 Embossed Carrier

Meets all EIA-481-2 Standards

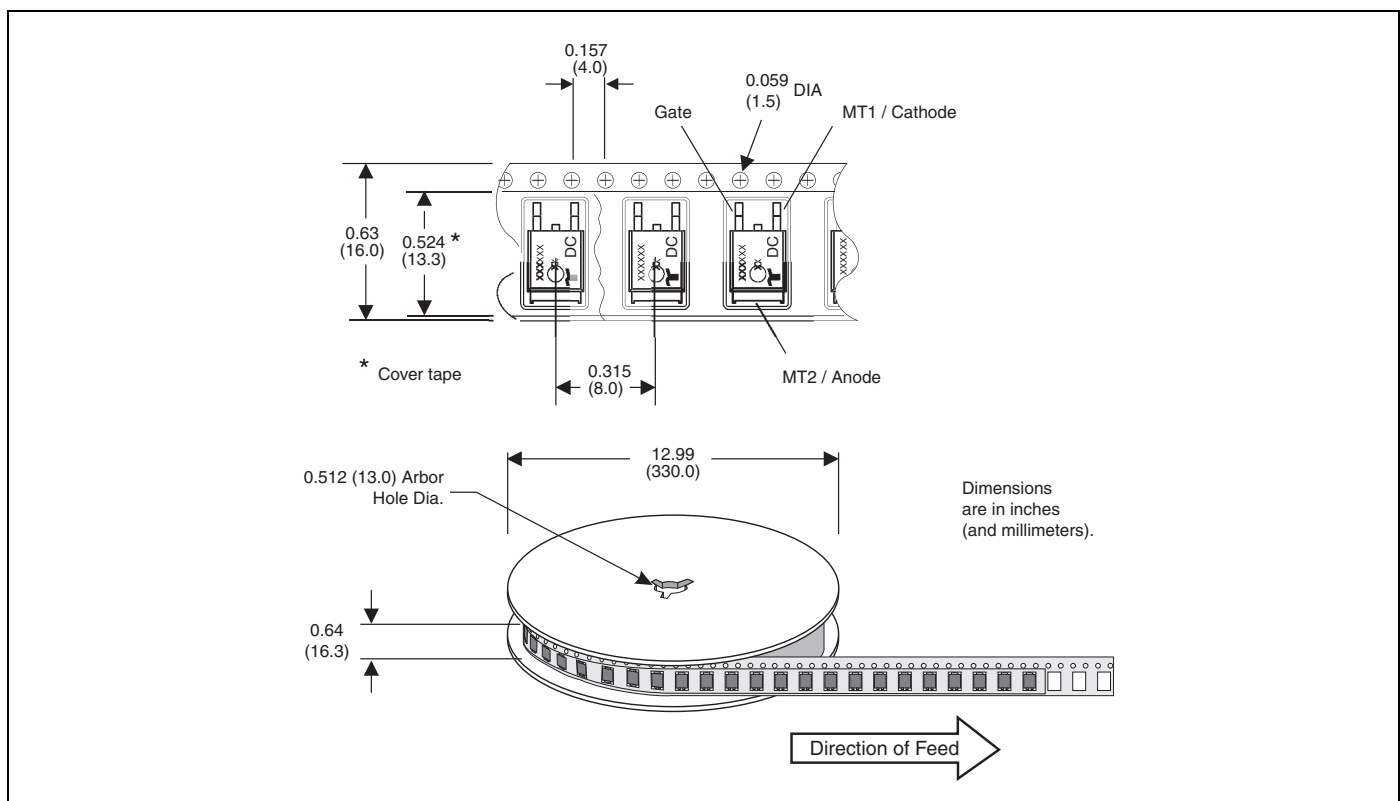

TO-263 Embossed Carrier Reel Pack (RP)

Meets all EIA-481-2 Standards

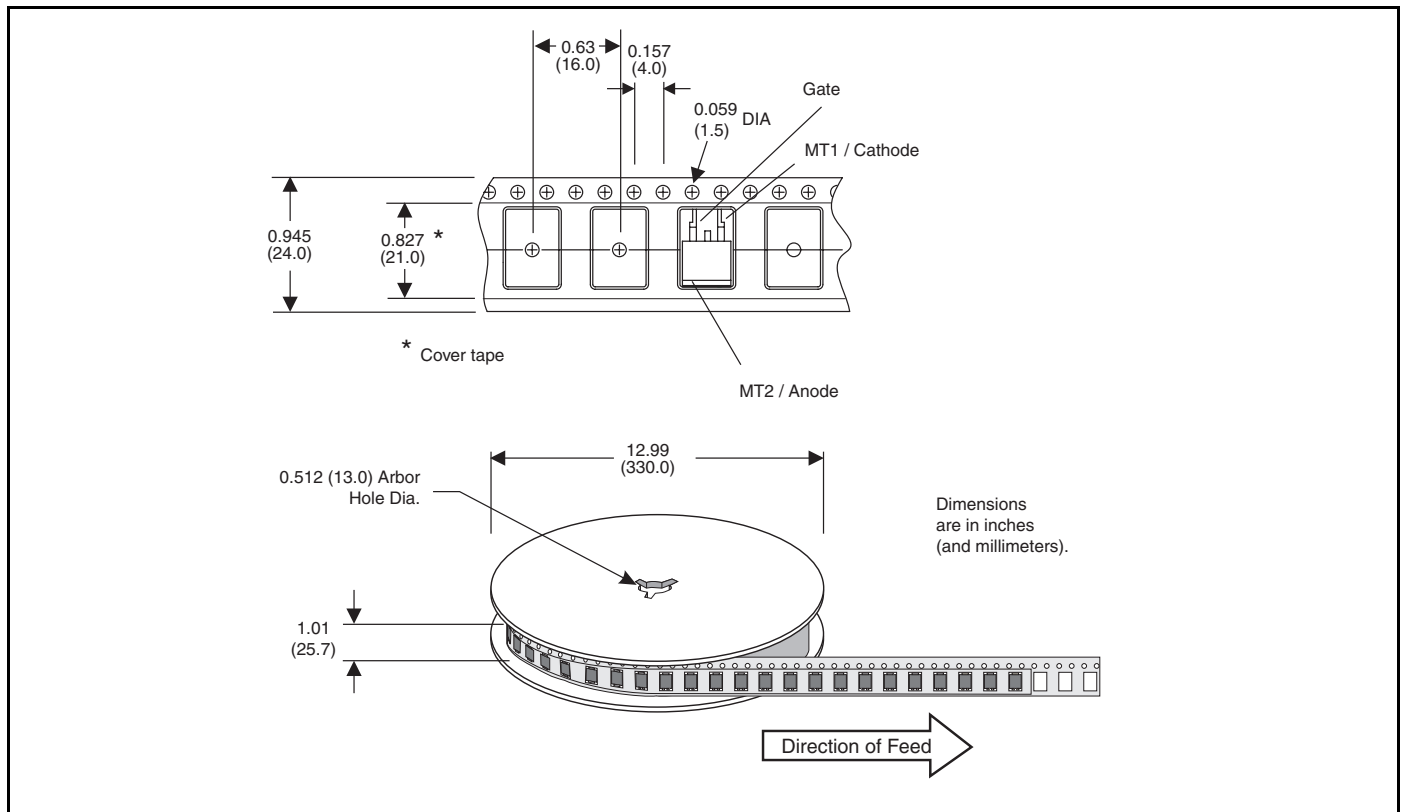

DO-214 Embossed Carrier Reel Pack (RP)

Meets all EIA-481-1 Standards

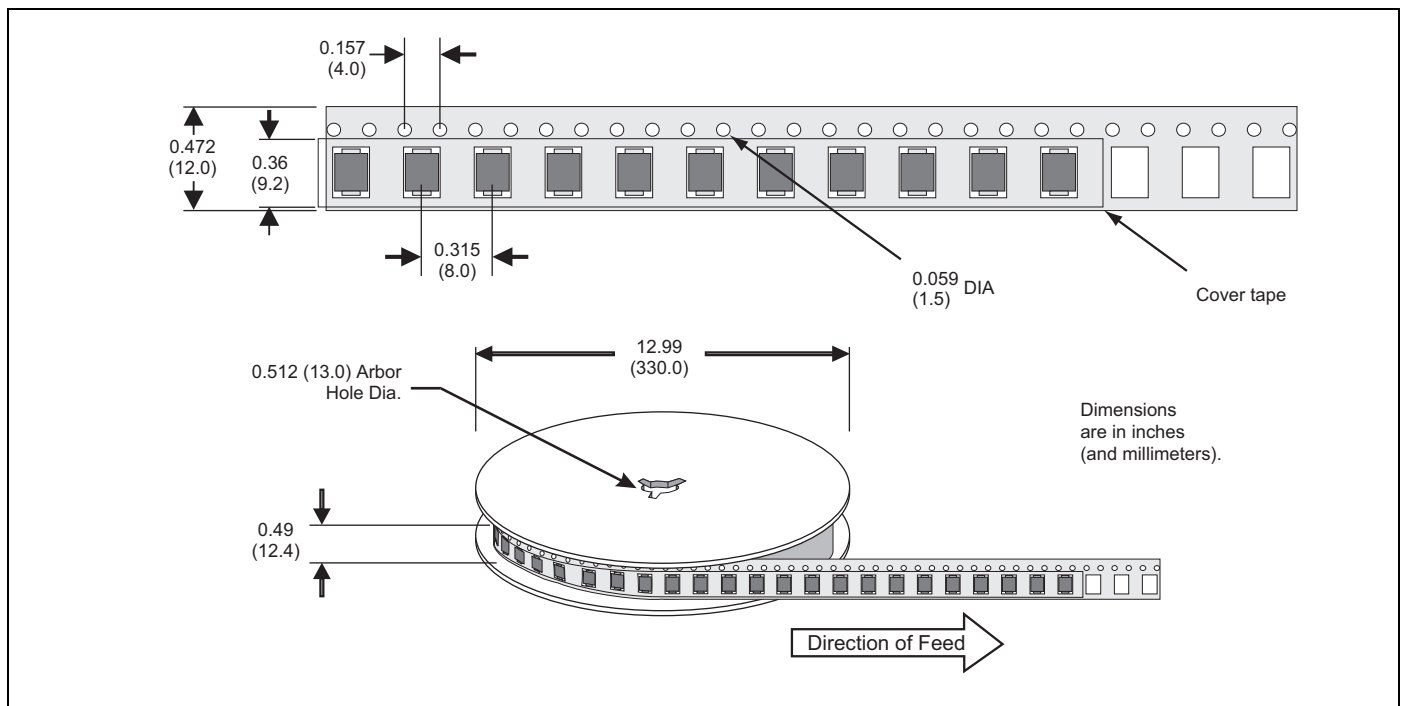

Compak Embossed Carrier Reel Pack (RP)

Meets all EIA-481-1 Standards

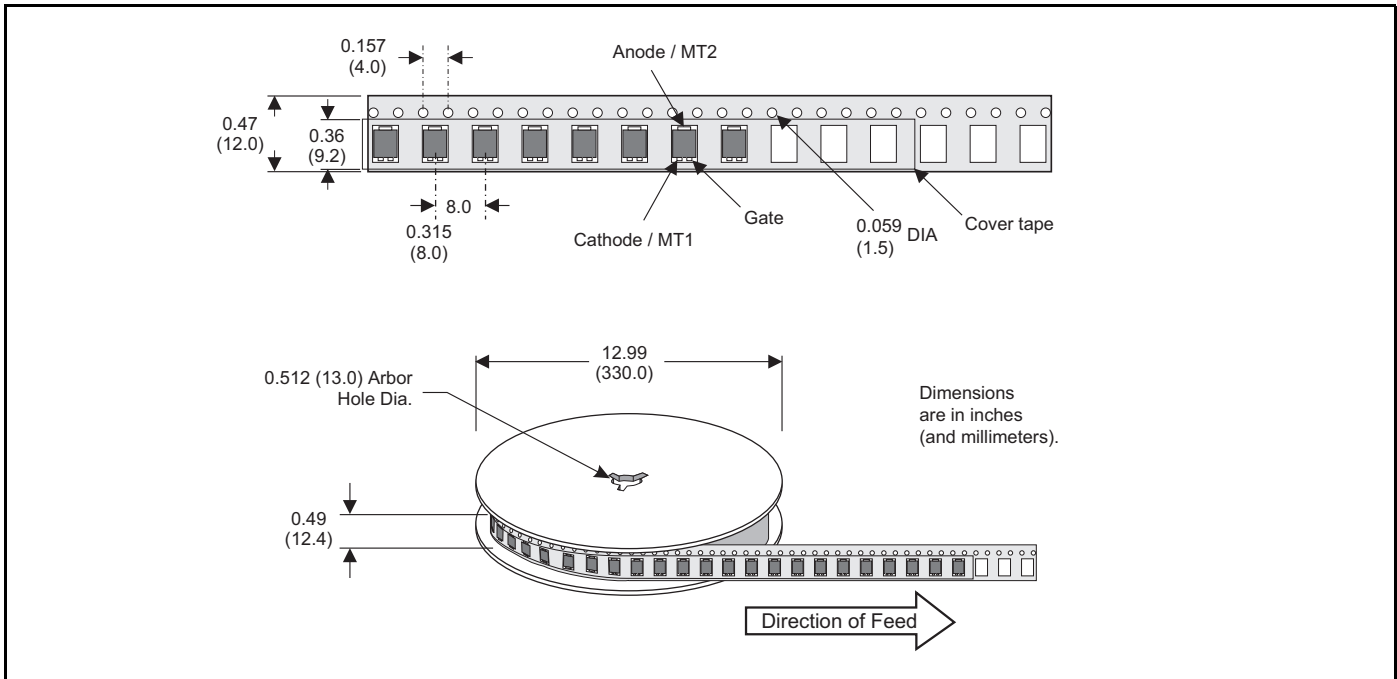

DO-15X and DO-35 Reel Pack (RP)

Meets all EIA RS-296 Standards

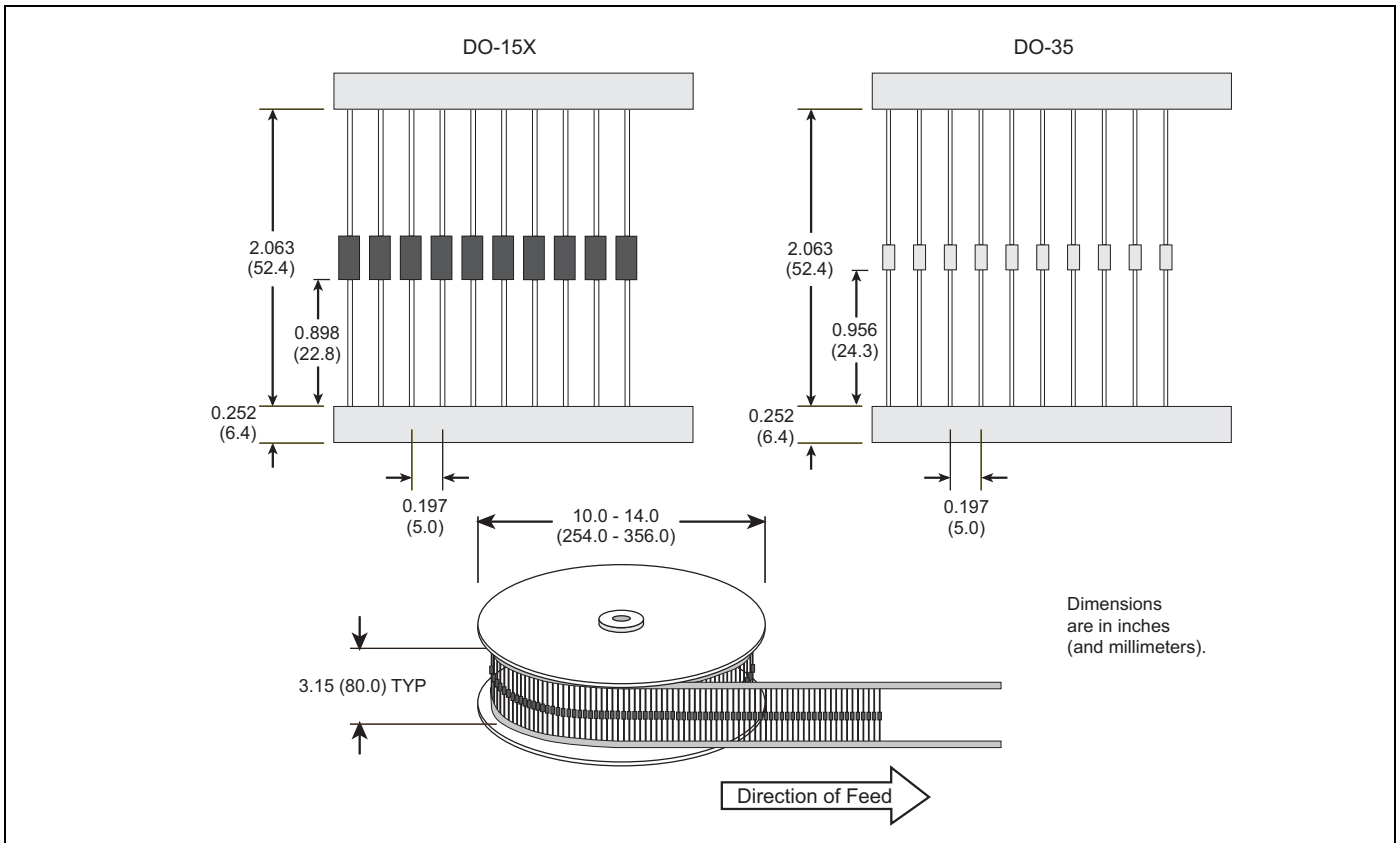

Application Notes

Fundamental Characteristics of Thyristors - - - - -	AN1001
Gating, Latching, and Holding of SCRs and Triacs - - - - -	AN1002
Phase Control Using Thyristors- - - - -	AN1003
Mounting and Handling of Semiconductor Devices - - - - -	AN1004
Surface Mount Soldering Recommendations - - - - -	AN1005
Testing Teccor Semiconductor Devices Using Curve Tracers - - - - -	AN1006
Thyristors Used as AC Static Switches and Relays- - - - -	AN1007
Explanation of Maximum Ratings and Characteristics for Thyristors- - - - -	AN1008
Miscellaneous Design Tips and Facts - - - - -	AN1009
Thyristors for Ignition of Fluorescent Lamps- - - - -	AN1010

Notes

Fundamental Characteristics of Thyristors

Introduction

The thyristor family of semiconductors consists of several very useful devices. The most widely used of this family are silicon controlled rectifiers (SCRs), triacs, sidacs, and diacs. In many applications these devices perform key functions and are real assets in meeting environmental, speed, and reliability specifications which their electro-mechanical counterparts cannot fulfill.

This application note presents the basic fundamentals of SCR, triac, sidac, and diac thyristors so the user understands how they differ in characteristics and parameters from their electro-mechanical counterparts. Also, thyristor terminology is defined.

SCR

Basic Operation

Figure AN1001.1 shows the simple block construction of an SCR.

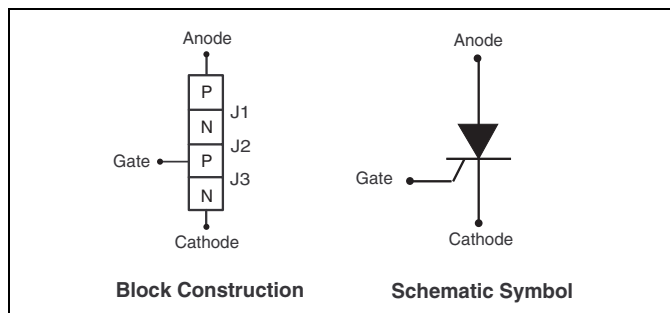

Figure AN1001.1 SCR Block Construction

The operation of a PNPN device can best be visualized as a specially coupled pair of transistors as shown in Figure AN1001.2.

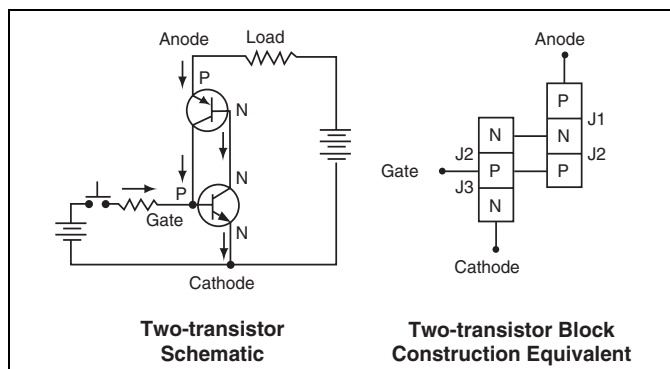

Figure AN1001.2 Coupled Pair of Transistors as a SCR

The connections between the two transistors trigger the occurrence of regenerative action when a proper gate signal is applied to the base of the NPN transistor. Normal leakage current is so low that the combined h_{FE} of the specially coupled two-transistor feedback amplifier is less than unity, thus keeping the circuit in an off-state condition. A momentary positive pulse applied to the gate biases the NPN transistor into conduction which, in turn, biases the PNP transistor into conduction. The effective h_{FE} momentarily becomes greater than unity so that the specially coupled transistors saturate. Once saturated, current through the transistors is enough to keep the combined h_{FE} greater than unity. The circuit remains "on" until it is "turned off" by reducing the anode-to-cathode current (I_T) so that the combined h_{FE} is less than unity and regeneration ceases. This threshold anode current is the holding current of the SCR.

Geometric Construction

Figure AN1001.3 shows cross-sectional views of an SCR chip and illustrations of current flow and junction biasing in both the blocking and triggering modes.

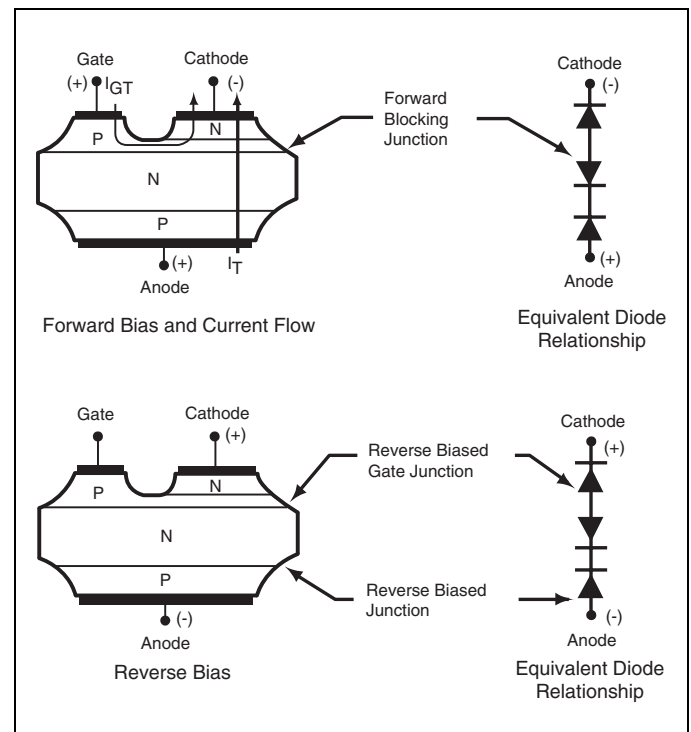

Figure AN1001.3 Cross-sectional View of SCR Chip

Triac

Basic Operation

Figure AN1001.4 shows the simple block construction of a triac. Its primary function is to control power bilaterally in an AC circuit.

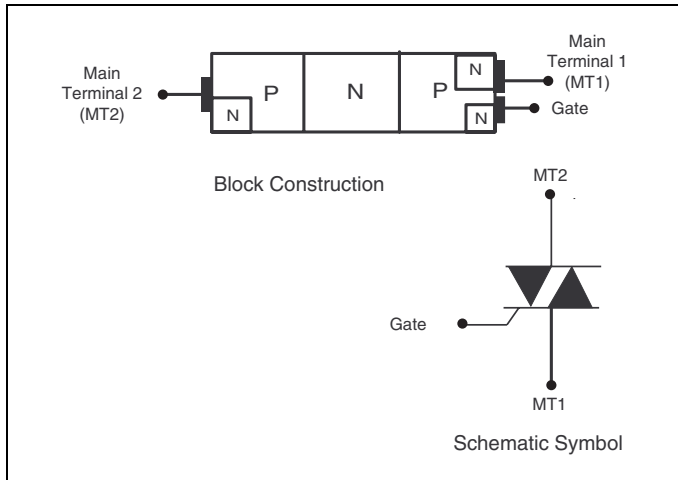

Figure AN1001.4 Triac Block Construction

Operation of a triac can be related to two SCRs connected in parallel in opposite directions as shown in Figure AN1001.5.

Although the gates are shown separately for each SCR, a triac has a single gate and can be triggered by either polarity.

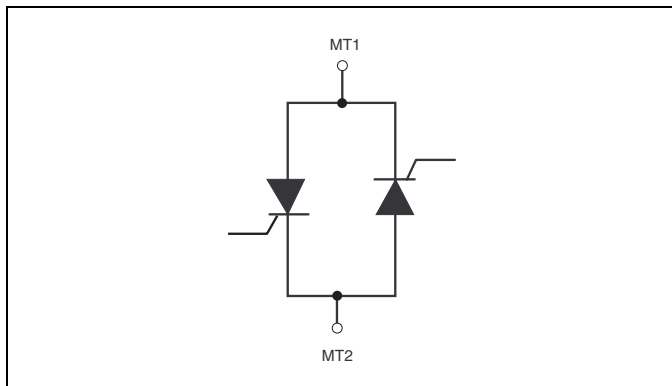

Figure AN1001.5 SCRs Connected as a Triac

Since a triac operates in both directions, it behaves essentially the same in either direction as an SCR would behave in the forward direction (blocking or operating).

Geometric Construction

Figure AN1001.6 show simplified cross-sectional views of a triac chip in various gating quadrants and blocking modes.

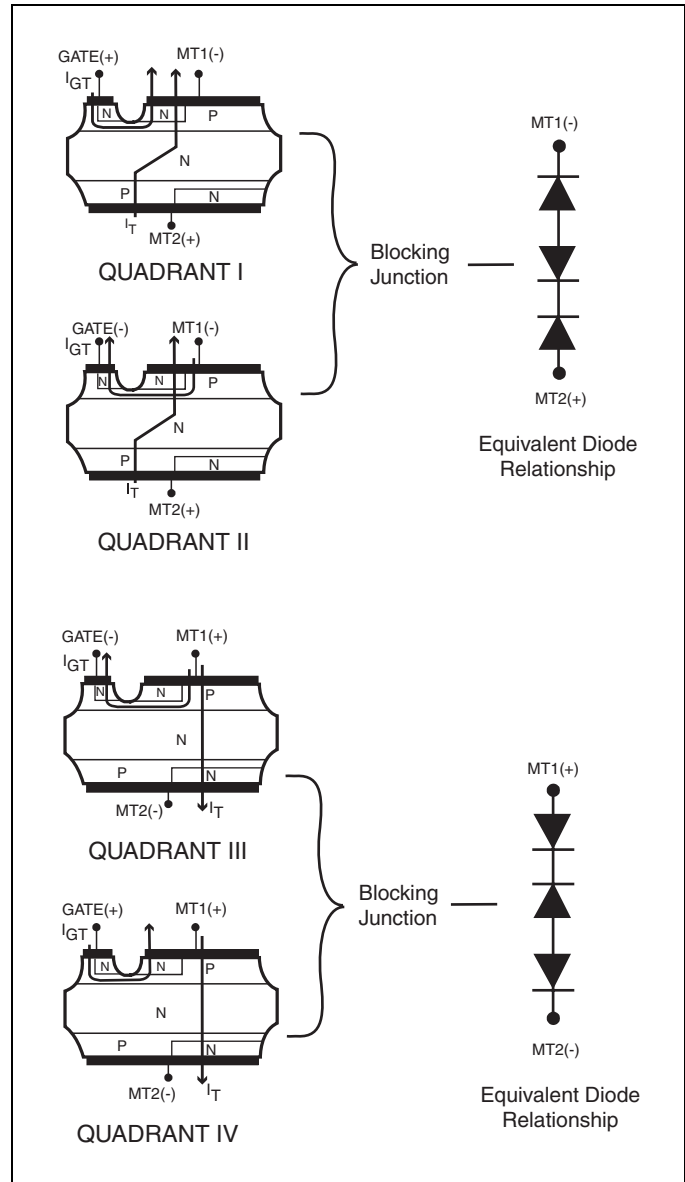

Figure AN1001.6 Simplified Cross-sectional of Triac Chip

Sidac

Basic Operation

The sidac is a multi-layer silicon semiconductor switch. Figure AN1001.7 illustrates its equivalent block construction using two Shockley diodes connected inverse parallel. Figure AN1001.7 also shows the schematic symbol for the sidac.

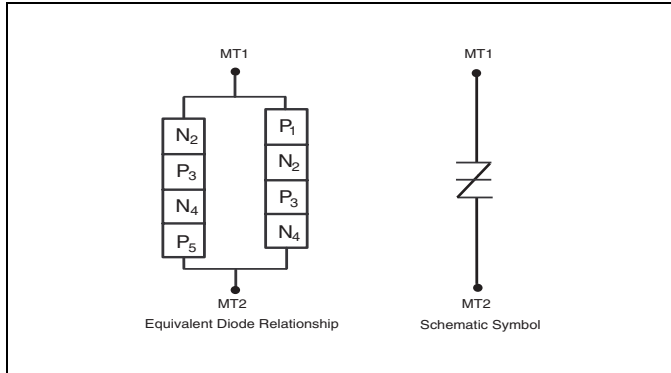

Figure AN1001.7 Sidac Block Construction

The sidac operates as a bidirectional switch activated by voltage. In the off state, the sidac exhibits leakage currents (I_{DRM}) less than $5 \mu A$. As applied voltage exceeds the sidac V_{BO} , the device begins to enter a negative resistance switching mode with characteristics similar to an avalanche diode. When supplied with enough current (I_S), the sidac switches to an on state, allowing high current to flow. When it switches to on state, the voltage across the device drops to less than 5 V, depending on magnitude of the current flow. When the sidac switches on and drops into regeneration, it remains on as long as holding current is less than maximum value (150 mA, typical value of 30 mA to 65 mA). The switching current (I_S) is very near the holding current (I_H) value. When the sidac switches, currents of 10 A to 100 A are easily developed by discharging small capacitor into primary or small, very high-voltage transformers for $10 \mu s$ to $20 \mu s$.

The main application for sidacs is ignition circuits or inexpensive high voltage power supplies.

Geometric Construction

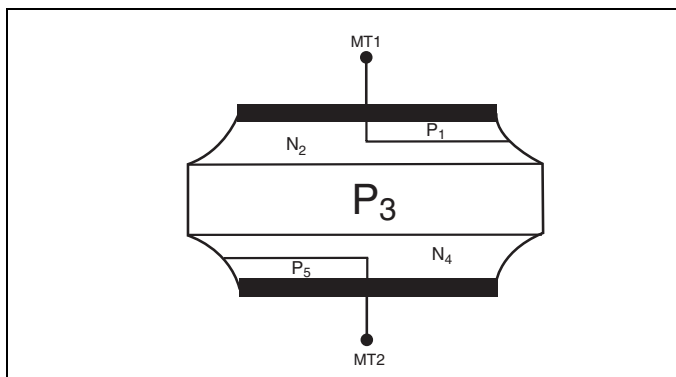

Figure AN1001.8 Cross-sectional View of a Bidirectional Sidac Chip with Multi-layer Construction

Diac

Basic Operation

The construction of a diac is similar to an open base NPN transistor. Figure AN1001.9 shows a simple block construction of a diac and its schematic symbol.

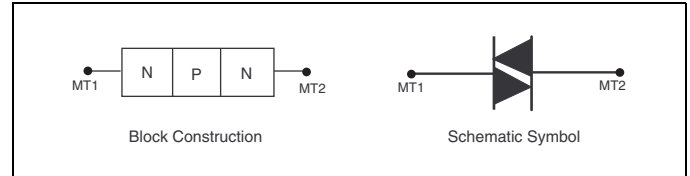

Figure AN1001.9 Diac Block Construction

The bidirectional transistor-like structure exhibits a high-impedance blocking state up to a voltage breakover point (V_{BO}) above which the device enters a negative-resistance region. These basic diac characteristics produce a bidirectional pulsing oscillator in a resistor-capacitor AC circuit. Since the diac is a bidirectional device, it makes a good economical trigger for firing triacs in phase control circuits such as light dimmers and motor speed controls. Figure AN1001.10 shows a simplified AC circuit using a diac and a triac in a phase control application.

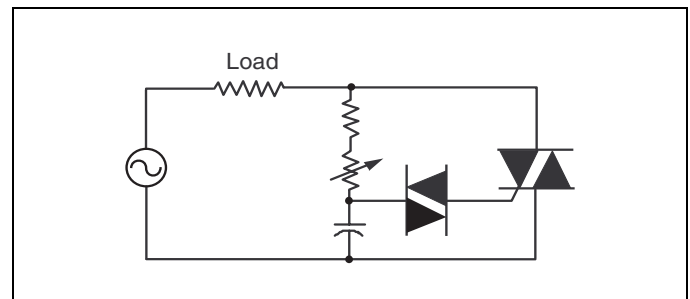

Figure AN1001.10 AC Phase Control Circuit

Geometric Construction

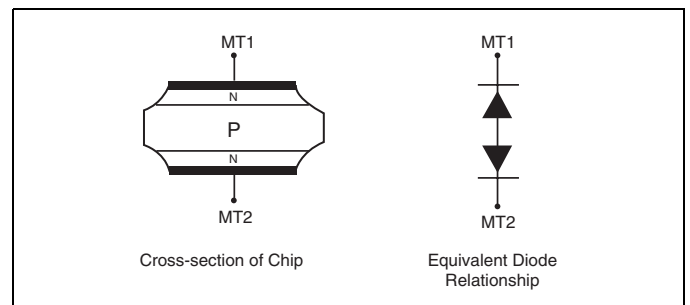

Figure AN1001.11 Cross-sectional View of Diac Chip

Electrical Characteristic Curves of Thyristors

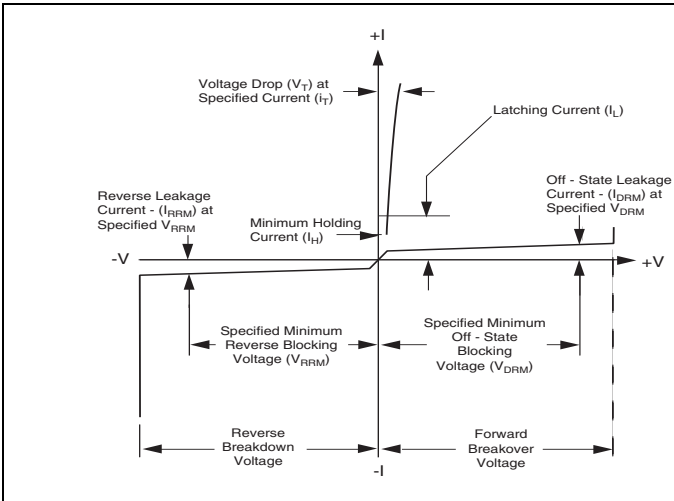

Figure AN1001.12 V-I Characteristics of SCR Device

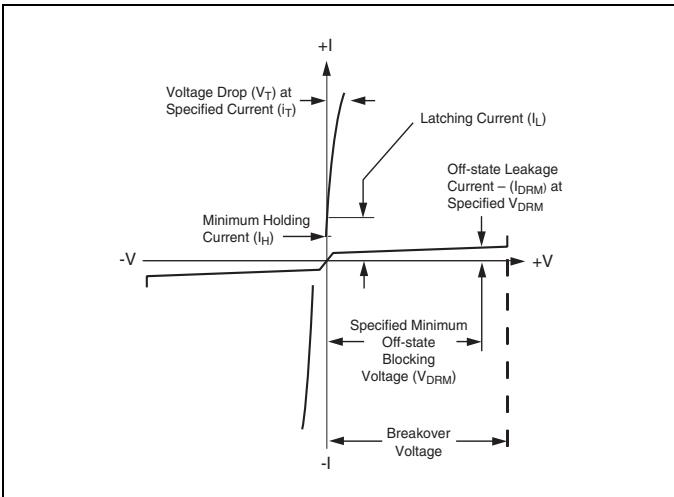

Figure AN1001.13 V-I Characteristics of Triac Device

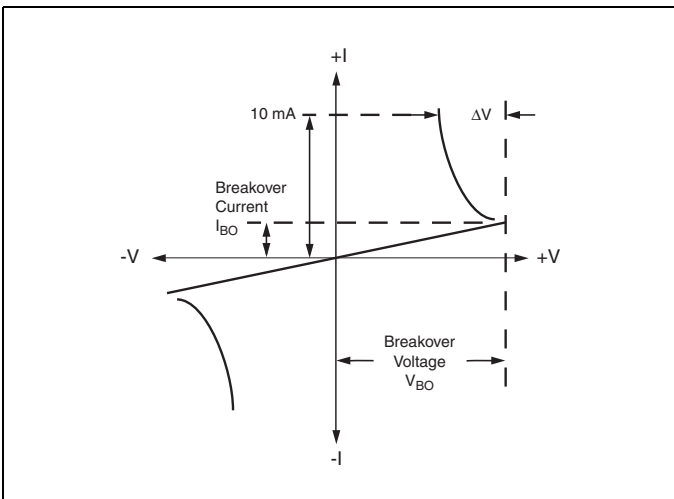

Figure AN1001.14 V-I Characteristics of Bilateral Trigger Diac

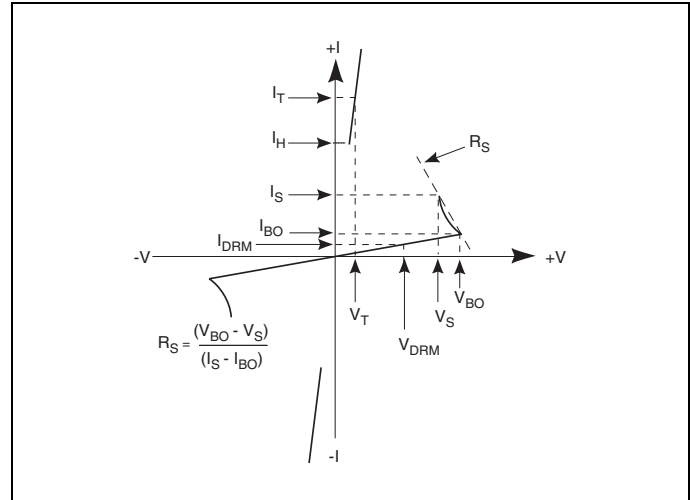

Figure AN1001.15 V-I Characteristics of a Sidac Chip

Methods of Switching on Thyristors

Three general methods are available for switching thyristors to on-state condition:

- Application of gate signal
- Static dv/dt turn-on
- Voltage breakover turn-on

Application Of Gate Signal

Gate signal must exceed I_{GT} and V_{GT} requirements of the thyristor used. For an SCR (unilateral device), this signal must be positive with respect to the cathode polarity. A triac (bilateral device) can be turned on with gate signal of either polarity; however, different polarities have different requirements of I_{GT} and V_{GT} which must be satisfied. Since diacs and sidacs do not have a gate, this method of turn-on is not applicable. In fact, the single major application of diacs is to switch on triacs.

Static dv/dt Turn-on

Static dv/dt turn-on comes from a fast-rising voltage applied across the anode and cathode terminals of an SCR or the main terminals of a triac. Due to the nature of thyristor construction, a small junction capacitor is formed across each PN junction. Figure AN1001.16 shows how typical internal capacitors are linked in gated thyristors.

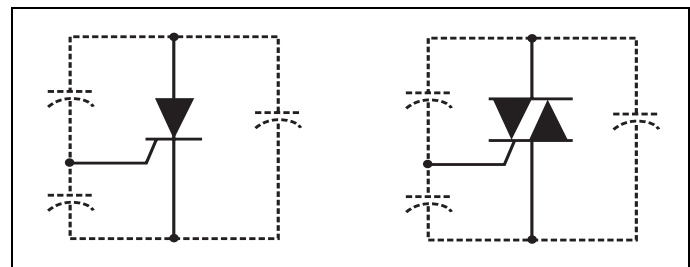

Figure AN1001.16 Internal Capacitors Linked in Gated Thyristors

When voltage is impressed suddenly across a PN junction, a charging current flows, equal to:

$$i = C \left(\frac{dv}{dt} \right)$$

When $C \left(\frac{dv}{dt} \right)$ becomes greater or equal to thyristor I_{GT} ,

the thyristor switches on. Normally, this type of turn-on does not damage the device, providing the surge current is limited.

Generally, thyristor application circuits are designed with static dv/dt snubber networks if fast-rising voltages are anticipated.

Voltage Breakover Turn-on

This method is used to switch on sidacs and diacs. However, exceeding voltage breakover of SCRs and triacs is definitely not recommended as a turn-on method.

In the case of SCRs and triacs, leakage current increases until it exceeds the gate current required to turn on these gated thyristors in a small localized point. When turn-on occurs by this method, localized heating in a small area may melt the silicon or damage the device if di/dt of the increasing current is not sufficiently limited.

Diacs used in typical phase control circuits are basically protected against excessive current at breakover as long as the firing capacitor is not excessively large. When diacs are used in a zener function, current limiting is necessary.

Sidacs are typically pulse-firing, high-voltage transformers and are current limited by the transformer primary. The sidac should be operated so peak current amplitude, current duration, and di/dt limits are not exceeded.

Triac Gating Modes Of Operation

Triacs can be gated in four basic gating modes as shown in Figure AN1001.17.

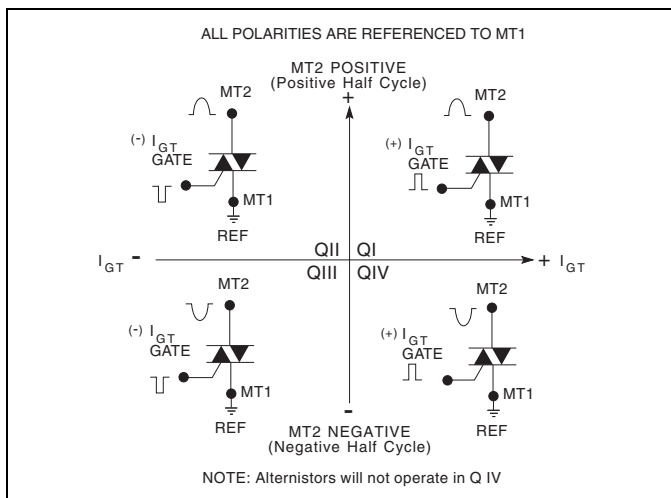

Figure AN1001.17 Gating Modes

The most common quadrants for triac gating-on are Quadrants I and III, where the gate supply is synchronized with the main terminal supply (gate positive — MT2 positive, gate negative — MT2 negative). Gate sensitivity of triacs is most optimum in Quadrants I and III due to the inherent thyristor chip construction. If Quadrants I and III cannot be used, the next best operating

modes are Quadrants II and III where the gate has a negative polarity supply with an AC main terminal supply. Typically, Quadrant II is approximately equal in gate sensitivity to Quadrant I; however, latching current sensitivity in Quadrant II is lowest. Therefore, it is difficult for triacs to latch on in Quadrant II when the main terminal current supply is very low in value.

Special consideration should be given to gating circuit design when Quadrants I and IV are used in actual application, because Quadrant IV has the lowest gate sensitivity of all four operating quadrants.

General Terminology

The following definitions of the most widely-used thyristor terms, symbols, and definitions conform to existing EIA-JEDEC standards:

Breakover Point – Any point on the principal voltage-current characteristic for which the differential resistance is zero and where the principal voltage reaches a maximum value

Principal Current – Generic term for the current through the collector junction (the current through main terminal 1 and main terminal 2 of a triac or anode and cathode of an SCR)

Principal Voltage – Voltage between the main terminals:

- (1) In the case of reverse blocking thyristors, the principal voltage is called positive when the anode potential is higher than the cathode potential and negative when the anode potential is lower than the cathode potential.
- (2) For bidirectional thyristors, the principal voltage is called positive when the potential of main terminal 2 is higher than the potential of main terminal 1.

Off State – Condition of the thyristor corresponding to the high-resistance, low-current portion of the principal voltage-current characteristic between the origin and the breakover point(s) in the switching quadrant(s)

On State – Condition of the thyristor corresponding to the low-resistance, low-voltage portion of the principal voltage-current characteristic in the switching quadrant(s).

Specific Terminology

Average Gate Power Dissipation $[P_{G(AV)}]$ – Value of gate power which may be dissipated between the gate and main terminal 1 (or cathode) averaged over a full cycle

Breakover Current (I_{BO}) – Principal current at the breakover point

Breakover Voltage (V_{BO}) – Principal voltage at the breakover point

Circuit-commutated Turn-off Time (t_c) – Time interval between the instant when the principal current has decreased to zero after external switching of the principal voltage circuit and the instant when the thyristor is capable of supporting a specified principal voltage without turning on

Critical Rate-of-rise of Commutation Voltage of a Triac (Commutating dv/dt) – Minimum value of the rate-of-rise of principal voltage which will cause switching from the off state to the on state immediately following on-state current conduction in the opposite quadrant

Critical Rate-of-rise of Off-state Voltage or Static dv/dt

(dv/dt) – Minimum value of the rate-of-rise of principal voltage which will cause switching from the off state to the on state

Critical Rate-of-rise of On-state Current (di/dt) – Maximum value of the rate-of-rise of on-state current that a thyristor can withstand without harmful effect

Gate-controlled Turn-on Time (t_{gt}) – Time interval between a specified point at the beginning of the gate pulse and the instant when the principal voltage (current) has dropped to a specified low value (or risen to a specified high value) during switching of a thyristor from off state to the on state by a gate pulse.

Gate Trigger Current (I_{GT}) – Minimum gate current required to maintain the thyristor in the on state

Gate Trigger Voltage (V_{GT}) – Gate voltage required to produce the gate trigger current

Holding Current (I_H) – Minimum principal current required to maintain the thyristor in the on state

Latching Current (I_L) – Minimum principal current required to maintain the thyristor in the on state immediately after the switching from off state to on state has occurred and the triggering signal has been removed

On-state Current (I_T) – Principal current when the thyristor is in the on state

On-state Voltage (V_T) – Principal voltage when the thyristor is in the on state

Peak Gate Power Dissipation (P_{GM}) – Maximum power which may be dissipated between the gate and main terminal 1 (or cathode) for a specified time duration

Repetitive Peak Off-state Current (I_{DRM}) – Maximum instantaneous value of the off-state current that results from the application of repetitive peak off-state voltage

Repetitive Peak Off-state Voltage (V_{DRM}) – Maximum instantaneous value of the off-state voltage which occurs across a thyristor, including all repetitive transient voltages and excluding all non-repetitive transient voltages

Repetitive Peak Reverse Current of an SCR (I_{RRM}) – Maximum instantaneous value of the reverse current resulting from the application of repetitive peak reverse voltage

Repetitive Peak Reverse Voltage of an SCR (V_{RRM}) – Maximum instantaneous value of the reverse voltage which occurs across the thyristor, including all repetitive transient voltages and excluding all non-repetitive transient voltages

Surge (Non-repetitive) On-state Current (I_{TSM}) – On-state current of short-time duration and specified waveshape

Thermal Resistance, Junction to Ambient ($R_{\theta JA}$) – Temperature difference between the thyristor junction and ambient divided by the power dissipation causing the temperature difference under conditions of thermal equilibrium

Note: Ambient is the point at which temperature does not change as the result of dissipation.

Thermal Resistance, Junction to Case ($R_{\theta JC}$) – Temperature difference between the thyristor junction and the thyristor case divided by the power dissipation causing the temperature difference under conditions of thermal equilibrium

Gating, Latching, and Holding of SCRs and Triacs

Introduction

Gating, latching, and holding currents of thyristors are some of the most important parameters. These parameters and their interrelationship determine whether the SCRs and triacs will function properly in various circuit applications.

This application note describes how the SCR and triac parameters are related. This knowledge helps users select best operating modes for various circuit applications.

Gating of SCRs and Triacs

Three general methods are available to switch thyristors to on-state condition:

- Applying proper gate signal
- Exceeding thyristor static dv/dt characteristics
- Exceeding voltage breakover point

This application note examines only the application of proper gate signal. Gate signal must exceed the I_{GT} and V_{GT} requirements of the thyristor being used. I_{GT} (gate trigger current) is the minimum gate current required to switch a thyristor from the off state to the on state. V_{GT} (gate trigger voltage) is the voltage required to produce the gate trigger current.

SCRs (unilateral devices) require a positive gate signal with respect to the cathode polarity. Figure AN1002.1 shows the current flow in a cross-sectional view of the SCR chip.

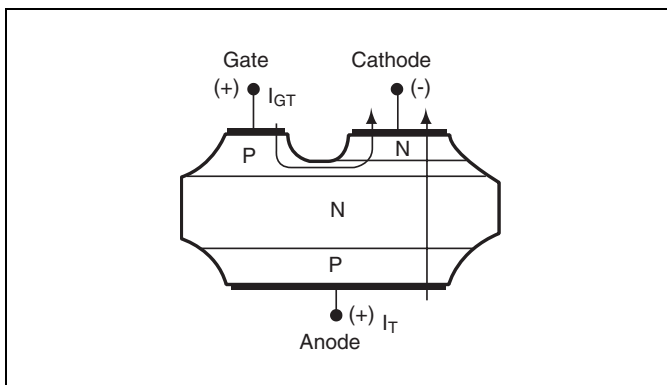

Figure AN1002.1 SCR Current Flow

In order for the SCR to latch on, the anode-to-cathode current (I_T) must exceed the latching current (I_L) requirement. Once latched on, the SCR remains on until it is turned off when anode-to-cathode current drops below holding current (I_H) requirement.

Triacs (bilateral devices) can be gated on with a gate signal of either polarity with respect to the MT1 terminal; however, different polarities have different requirements of I_{GT} and V_{GT} . Figure AN1002.2 illustrates current flow through the triac chip in various gating modes.

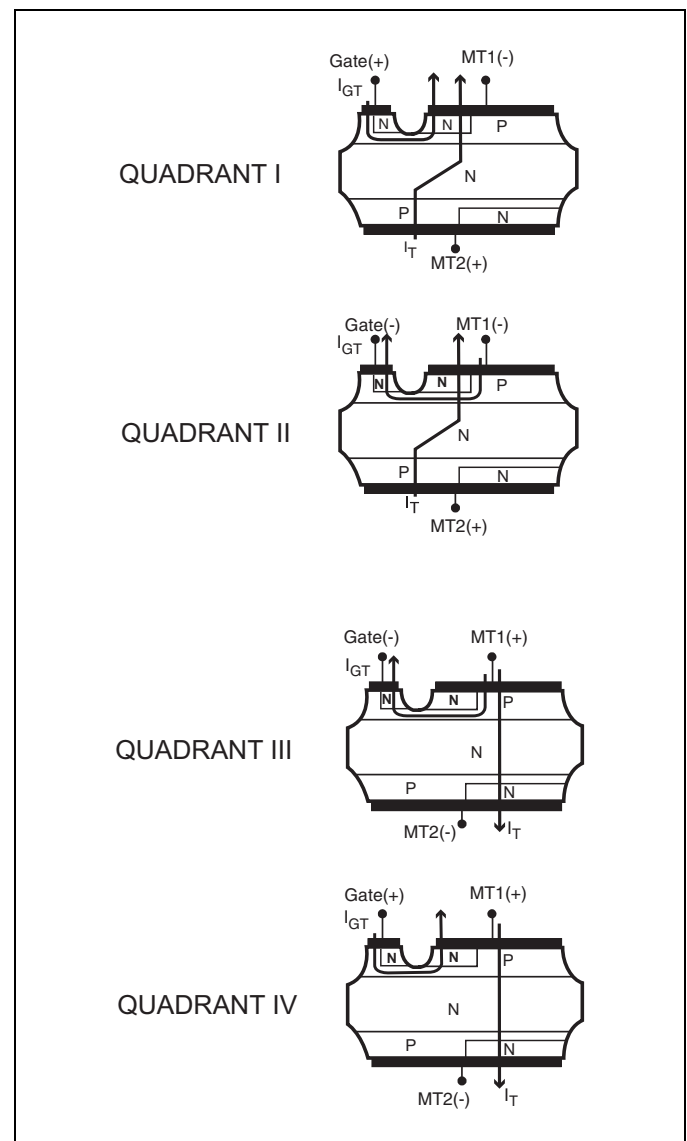

Figure AN1002.2 Triac Current Flow (Four Operating Modes)

Triacs can be gated on in one of four basic gating modes as shown in Figure AN1002.3. The most common quadrants for gating on triacs are Quadrants I and III, where the gate supply is synchronized with the main terminal supply (gate positive — MT2 positive, gate negative — MT2 negative). Optimum triac gate sensitivity is achieved when operating in Quadrants I and III due to the inherent thyristor chip construction. If Quadrants I and III cannot be used, the next best operating modes are Quadrants II and IV where the gate supply has a negative polarity with an AC main terminal supply. Typically, Quadrant II is approximately equal in gate sensitivity to Quadrant I; however, latching current sensitivity in Quadrant II is lowest. Therefore, it is difficult for triacs to latch on in Quadrant II when the main terminal current supply is very low in value.

Special consideration should be given to gating circuit design when Quadrants I and IV are used in actual application, because Quadrant IV has the lowest gate sensitivity of all four operating quadrants.

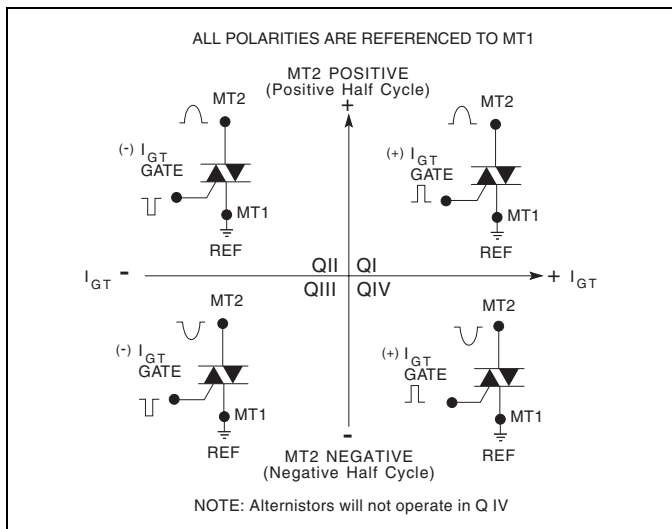

Figure AN1002.3 Definition of Operating Quadrants in Triacs

The following table shows the relationships between different gating modes in current required to gate on triacs.

Typical Ratio of $\frac{I_{GT}(\text{In given Quadrant})}{I_{GT}(\text{Quadrant 1})}$ at 25 °C				
Type	Operating Mode			
	Quadrant I	Quadrant II	Quadrant III	Quadrant IV
4 A Triac	1	1.6	2.5	2.7
10 A Triac	1	1.5	1.4	3.1

Example of 4 A triac:

- If $I_{GT(I)} = 10 \text{ mA}$, then
- $I_{GT(II)} = 16 \text{ mA}$
- $I_{GT(III)} = 25 \text{ mA}$
- $I_{GT(IV)} = 27 \text{ mA}$

Gate trigger current is temperature-dependent as shown in Figure AN1002.4. Thyristors become less sensitive with decreasing temperature and more sensitive with increasing temperature.

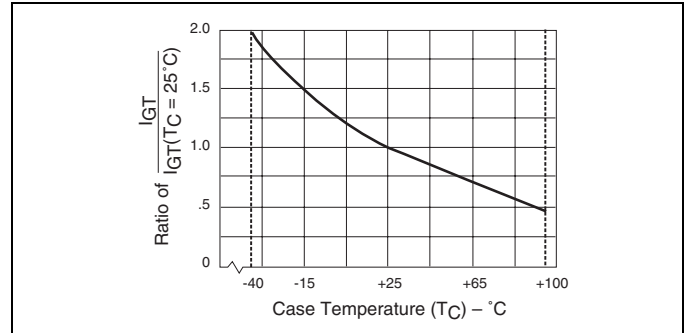

Figure AN1002.4 Typical DC Gate Trigger Current versus Case Temperature

For applications where low temperatures are expected, gate current supply should be increased to at least two to eight times the gate trigger current requirements at 25 °C. The actual factor varies by thyristor type and the environmental temperature.

Example of a 10 A triac:

- If $I_{GT(I)} = 10 \text{ mA}$ at 25 °C, then
- $I_{GT(I)} = 20 \text{ mA}$ at -40 °C

In applications where high di/dt, high surge, and fast turn-on are expected, gate drive current should be steep rising (1 μs rise time) and at least twice rated I_{GT} or higher with minimum 3 μs pulse duration. However, if gate drive current magnitude is very high, then duration may have to be limited to keep from over-stressing (exceeding the power dissipation limit of) gate junction.

Latching Current of SCRs and Triacs

Latching current (I_L) is the minimum principal current required to maintain the thyristor in the on state immediately after the switching from off state to on state has occurred and the triggering signal has been removed. Latching current can best be understood by relating to the “pick-up” or “pull-in” level of a mechanical relay. Figure AN1002.5 and Figure AN1002.6 illustrate typical thyristor latching phenomenon.

In the illustrations in Figure AN1002.5, the thyristor does not stay on after gate drive is removed due to insufficient available principal current (which is lower than the latching current requirement).

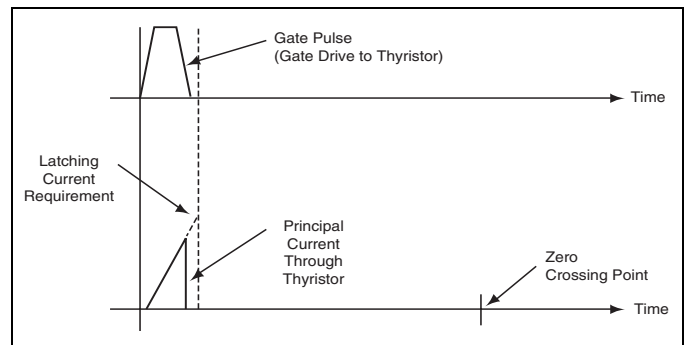

Figure AN1002.5 Latching Characteristic of Thyristor (Device Not Latched)

In the illustration in Figure AN1002.6 the device stays on for the remainder of the half cycle until the principal current falls below the holding current level. Figure AN1002.5 shows the characteristics of the same device if gate drive is removed or shortened before latching current requirement has been met.

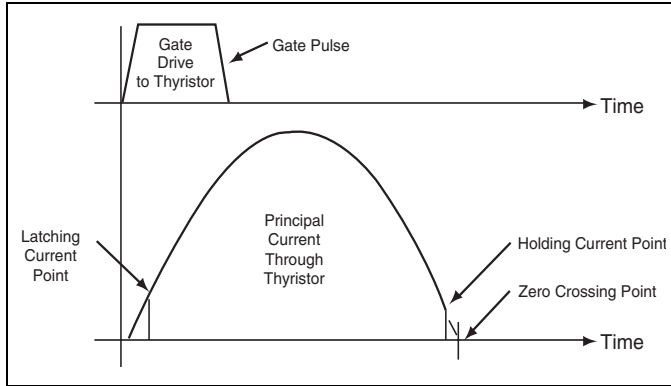

Figure AN1002.6 Latching and Holding Characteristics of Thyristor

Similar to gating, latching current requirements for triacs are different for each operating mode (quadrant). Definitions of latching modes (quadrants) are the same as gating modes. Therefore, definitions shown in Figure AN1002.2 and Figure AN1002.3 can be used to describe latching modes (quadrants) as well. The following table shows how different latching modes (quadrants) relate to each other. As previously stated, Quadrant II has the lowest latching current sensitivity of all four operating quadrants.

Typical Ratio of $\frac{I_L(\text{In given Quadrant})}{I_L(\text{Quadrant 1})}$ at 25 °C				
Type	Operating Mode			
	Quadrant I	Quadrant II	Quadrant III	Quadrant IV
4 A Triac	1	4	1.2	1.1
10 A Triac	1	4	1.1	1

Example of a 4 Amp Triac:

- If $I_L(I) = 10 \text{ mA}$, then
- $I_L(II) = 40 \text{ mA}$
- $I_L(III) = 12 \text{ mA}$
- $I_L(IV) = 11 \text{ mA}$

Latching current has even somewhat greater temperature dependence compared to the DC gate trigger current. Applications with low temperature requirements should have sufficient principal current (anode current) available to ensure thyristor latch-on.

Two key test conditions on latching current specifications are gate drive and available principal (anode) current durations. Shortening the gate drive duration can result in higher latching current values.

Holding Current of SCRs and Triacs

Holding current (I_H) is the minimum principal current required to maintain the thyristor in the on state. Holding current can best be understood by relating it to the "drop-out" or "must release" level of a mechanical relay. Figure AN1002.6 shows the sequences of gate, latching, and holding currents. Holding current will always be less than latching. However, the more sensitive the device, the closer the holding current value approaches its latching current value.

Holding current is independent of gating and latching, but the device must be fully latched on before a holding current limit can be determined.

Holding current modes of the thyristor are strictly related to the voltage polarity across the main terminals. The following table illustrates how the positive and negative holding current modes of triacs relate to each other.

Typical Triac Holding Current Ratio		
Type	Operating Mode	
	$I_H(+)$	$I_H(-)$
4 A Triac	1	1.1
10 A Triac	1	1.3

Example of a 10 A triac:

- If $I_H(+)$ = 10 mA, then
- $I_H(-)$ = 13 mA

Holding current is also temperature-dependent like gating and latching shown in Figure AN1002.7. The initial on-state current is 200 mA to ensure that the thyristor is fully latched on prior to holding current measurement. Again, applications with low temperature requirements should have sufficient principal (anode) current available to maintain the thyristor in the on-state condition.

Both minimum and maximum holding current specifications may be important, depending on application. Maximum holding current must be considered if the thyristor is to stay in conduction at low principal (anode) current; the minimum holding current must be considered if the device is expected to turn off at a low principal (anode) current.

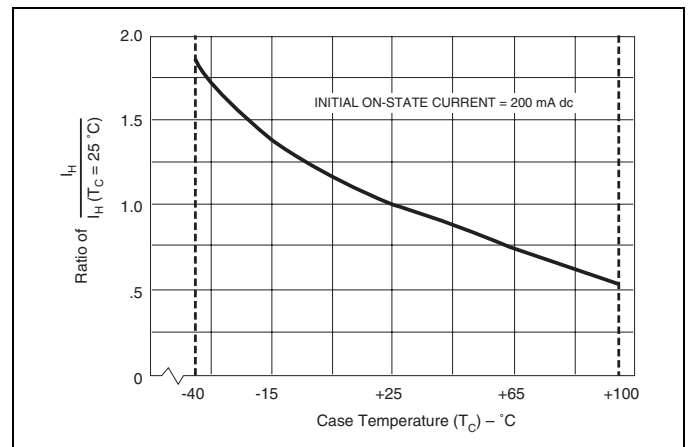

Figure AN1002.7 Typical DC Holding Current vs Case Temperatures

Example of a 10 A triac:

- If $I_H(+)$ = 10 mA at 25 °C, then
- $I_H(+)$ ≈ 7.5 mA at 65 °C

Relationship of Gating, Latching, and Holding Currents

Although gating, latching, and holding currents are independent of each other in some ways, the parameter values are related. If gating is very sensitive, latching and holding will also be very sensitive and vice versa. One way to obtain a sensitive gate and not-so-sensitive latching-holding characteristic is to have an "amplified gate" as shown in Figure AN1002.8.

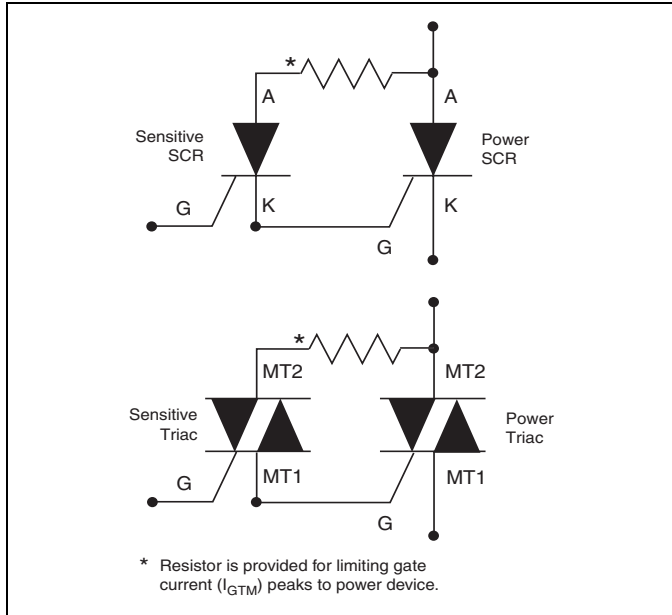

Figure AN1002.8 "Amplified Gate" Thyristor Circuit

The following table and Figure AN1002.9 show the relationship of gating, latching, and holding of a 4 A device.

Typical 4 A Triac Gating, Latching, and Holding Relationship				
Parameter	Quadrants or Operating Mode			
	Quadrant I	Quadrant II	Quadrant III	Quadrant IV
I_{GT} (mA)	10	17	18	27
I_L (mA)	12	48	12	13
I_H (mA)	10	10	12	12

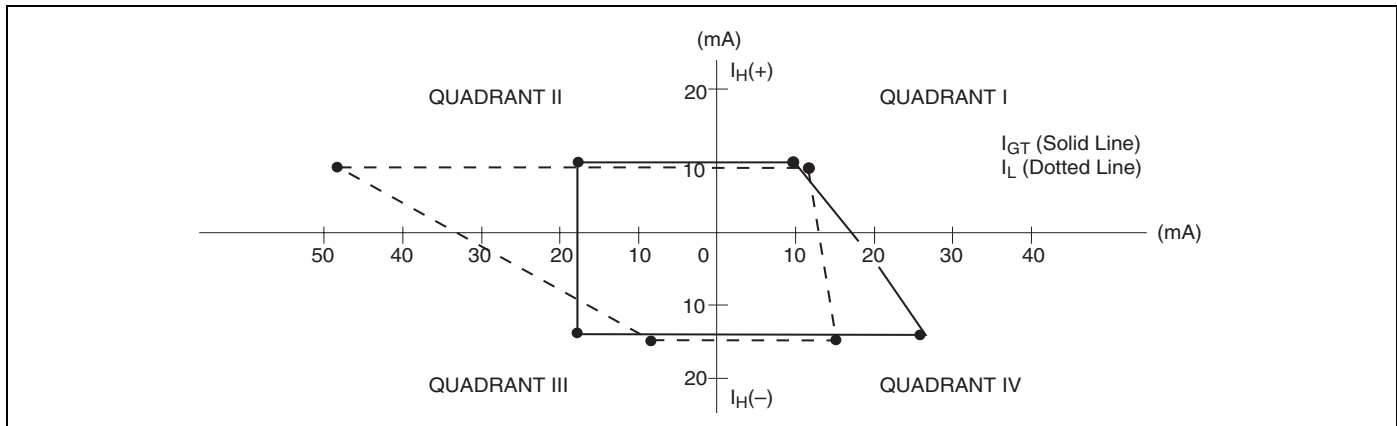

Figure AN1002.9 Typical Gating, Latching, and Holding Relationships of 4 A Triac at 25 °C

The relationships of gating, latching, and holding for several device types are shown in the following table. For convenience all ratios are referenced to Quadrant I gating.

Typical Ratio of Gating, Latching, and Holding Currents at 25 °C									
Devices	Ratio								
	$\frac{I_{GT(II)}}{I_{GT(I)}}$	$\frac{I_{GT(III)}}{I_{GT(I)}}$	$\frac{I_{GT(IV)}}{I_{GT(I)}}$	$\frac{I_L(I)}{I_{GT(I)}}$	$\frac{I_L(II)}{I_{GT(I)}}$	$\frac{I_L(III)}{I_{GT(I)}}$	$\frac{I_L(IV)}{I_{GT(I)}}$	$\frac{I_H(+)}{I_{GT(I)}}$	$\frac{I_H(-)}{I_{GT(I)}}$
4 A Triac	1.6	2.5	2.7	1.2	4.8	1.2	1.3	1.0	1.2
10 A Triac	1.5	1.4	3.1	1.6	4.0	1.8	2.0	1.1	1.6
15 A Alternistor	1.5	1.8	-	2.4	7.0	2.1	-	2.2	1.9
1 A Sensitive SCR	-	-	-	25	-	-	-	25	-
6 A SCR	-	-	-	3.2	-	-	-	2.6	-

Examples of a 10 A triac:

If $I_{GT(I)} = 10 \text{ mA}$, then

$I_{GT(II)} = 15 \text{ mA}$

$I_{GT(III)} = 14 \text{ mA}$

$I_{GT(IV)} = 31 \text{ mA}$

If $I_L(I) = 16 \text{ mA}$, then

$I_L(II) = 40 \text{ mA}$

$I_L(III) = 18 \text{ mA}$

$I_L(IV) = 20 \text{ mA}$

If $I_H(+)$ = 11 mA at 25 °C, then

$I_H(+)$ = 16 mA

Summary

Gating, latching, and holding current characteristics of thyristors are quite important yet predictable (once a single parameter value is known). Their interrelationships (ratios) can also be used to help designers in both initial circuit application design as well as device selection.

Notes

Phase Control Using Thyristors

Introduction

Due to high-volume production techniques, thyristors are now priced so that almost any electrical product can benefit from electronic control. A look at the fundamentals of SCR and triac phase controls shows how this is possible.

Output Power Characteristics

Phase control is the most common form of thyristor power control. The thyristor is held in the off condition — that is, all current flow in the circuit is blocked by the thyristor except a minute leakage current. Then the thyristor is triggered into an “on” condition by the control circuitry.

For full-wave AC control, a single triac or two SCRs connected in inverse parallel may be used. One of two methods may be used for full-wave DC control — a bridge rectifier formed by two SCRs or an SCR placed in series with a diode bridge as shown in Figure AN1003.1.

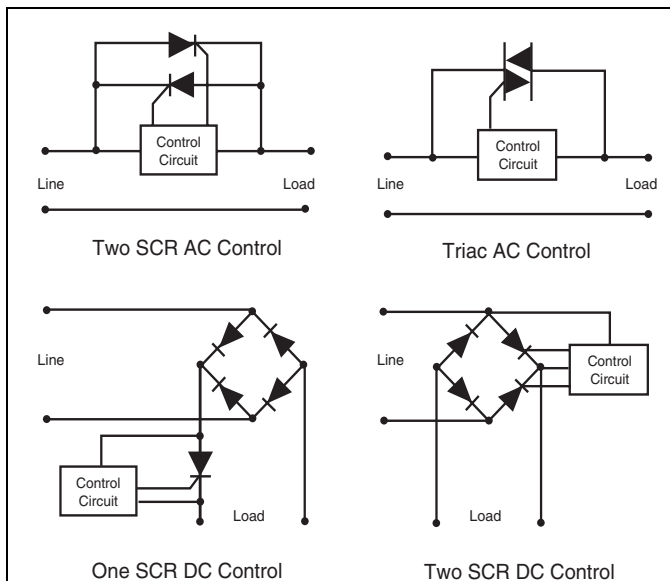

Figure AN1003.1 SCR/Triac Connections for Various Methods of Phase Control

Figure AN1003.2 illustrates voltage waveform and shows common terms used to describe thyristor operation. Delay angle is the time during which the thyristor blocks the line voltage. The conduction angle is the time during which the thyristor is on.

It is important to note that the circuit current is determined by the load and power source. For simplification, assume the load is resistive; that is, both the voltage and current waveforms are identical.

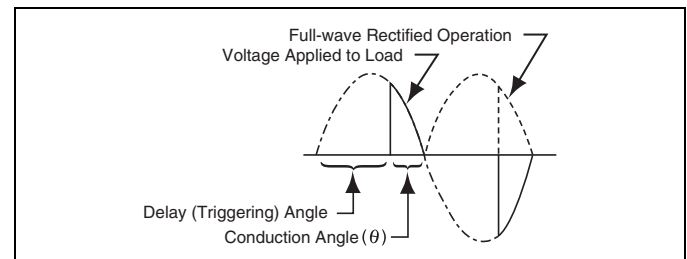

Figure AN1003.2 Sine Wave Showing Principles of Phase Control

Different loads respond to different characteristics of the AC waveform. For example, some are sensitive to average voltage, some to RMS voltage, and others to peak voltage. Various voltage characteristics are plotted against conduction angle for half- and full-wave phase control circuits in Figure AN1003.3 and Figure AN1003.4.

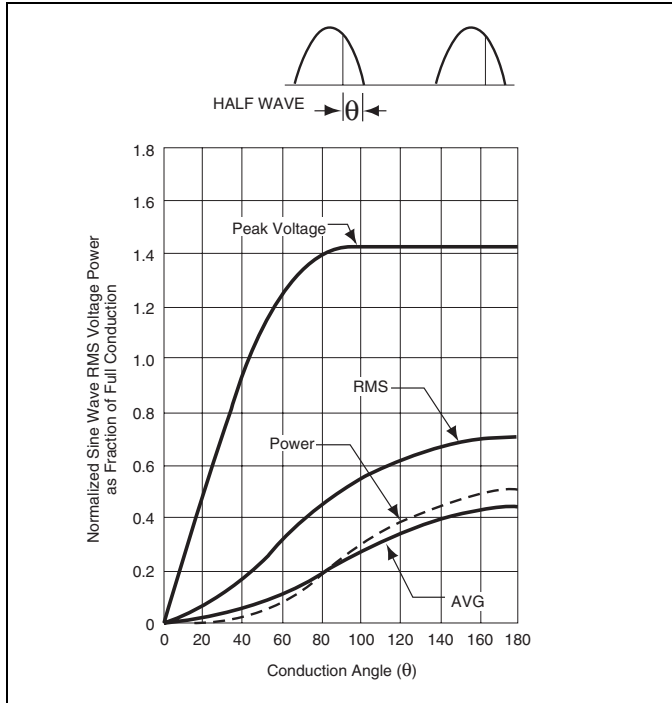

Figure AN1003.3 Half-Wave Phase Control (Sinusoidal)

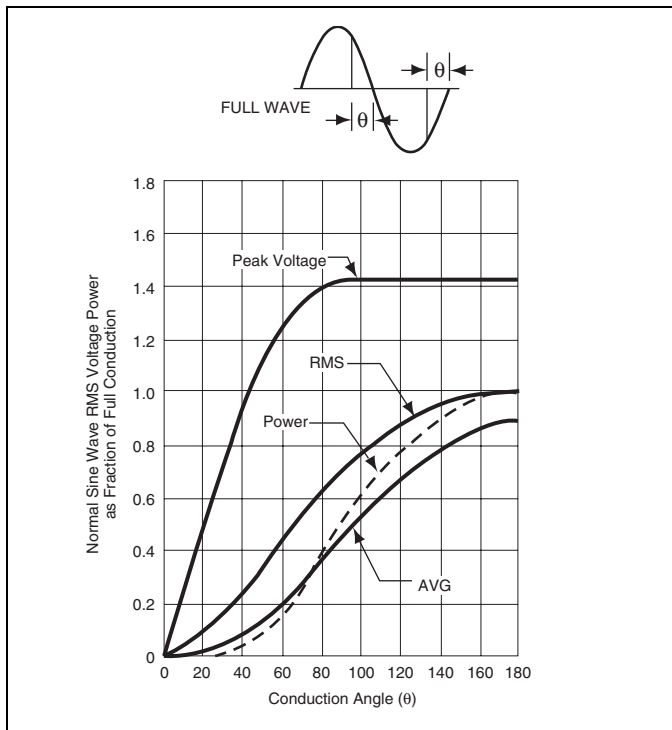

Figure AN1003.4 Symmetrical Full-Wave Phase Control (Sinusoidal)

Figure AN1003.3 and Figure AN1003.4 also show the relative power curve for constant impedance loads such as heaters. Because the relative impedance of incandescent lamps and motors change with applied voltage, they do not follow this curve precisely. To use the curves, find the full-wave rated power of the load, and then multiply by the ratio associated with the specific

phase angle. Thus, a 180° conduction angle in a half-wave circuit provides 0.5 x full-wave conduction power.

In a full-wave circuit, a conduction angle of 150° provides 97% full power while a conduction angle of 30° provides only 3% of full power control. Therefore, it is usually pointless to obtain conduction angles less than 30° or greater than 150°.

Figure AN1003.5 and Figure AN1003.6 give convenient direct output voltage readings for 115 V/230 V input voltage. These curves also apply to current in a resistive circuit.

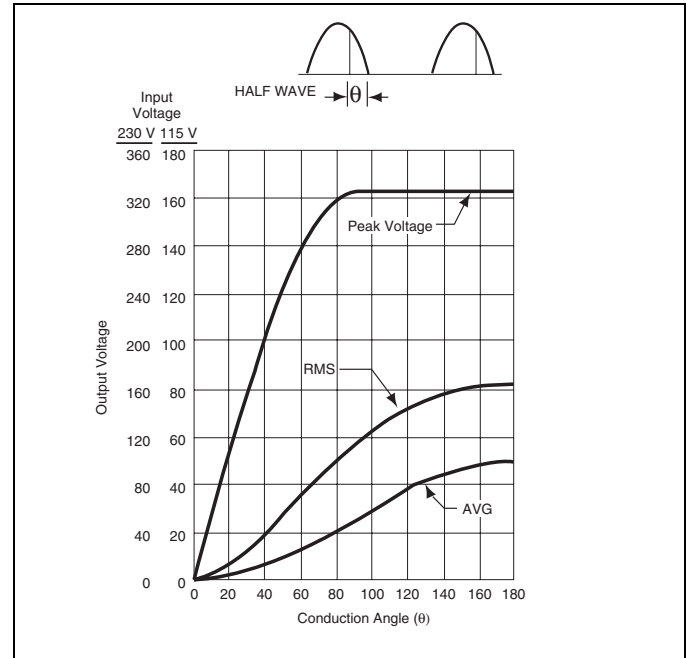

Figure AN1003.5 Output Voltage of Half-wave Phase

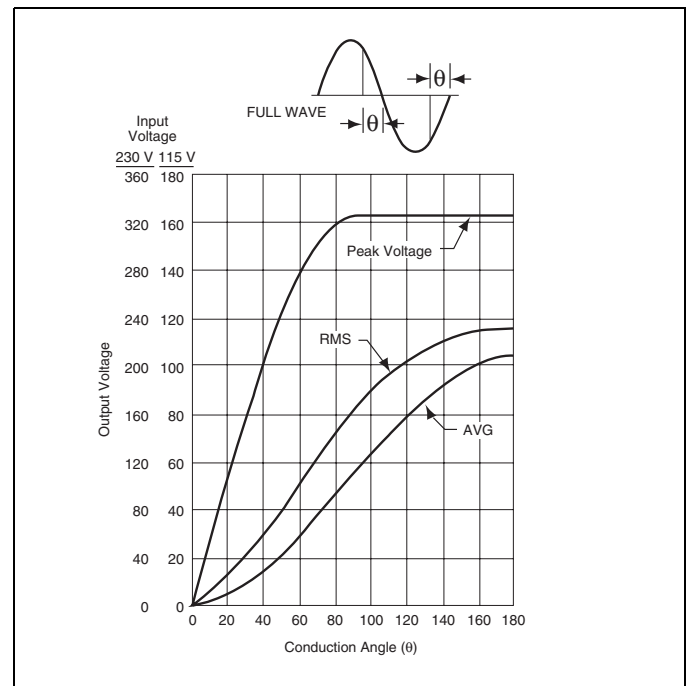

Figure AN1003.6 Output Voltage of Full-wave Phase Control

Control Characteristics

A relaxation oscillator is the simplest and most common control circuit for phase control. Figure AN1003.7 illustrates this circuit as it would be used with a thyristor. Turn-on of the thyristor occurs when the capacitor is charged through the resistor from a voltage or current source until the breakover voltage of the switching device is reached. Then, the switching device changes to its on state, and the capacitor is discharged through the thyristor gate. Trigger devices used are neon bulbs, unijunction transistors, and three-, four-, or five-layer semiconductor trigger devices. Phase control of the output waveform is obtained by varying the RC time constant of the charging circuit so the trigger device breakdown occurs at different phase angles within the controlled half or full cycle.

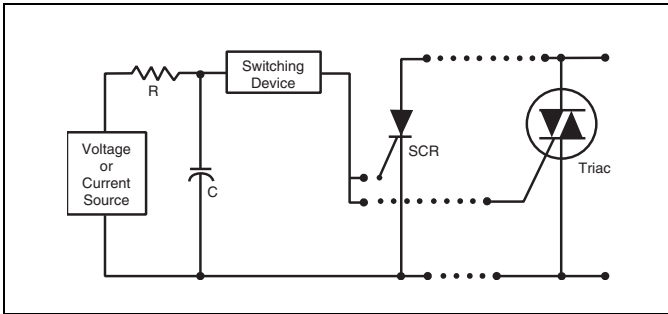

Figure AN1003.7 Relaxation Oscillator Thyristor Trigger Circuit

Figure AN1003.8 shows the capacitor voltage-time characteristic if the relaxation oscillator is to be operated from a pure DC source.

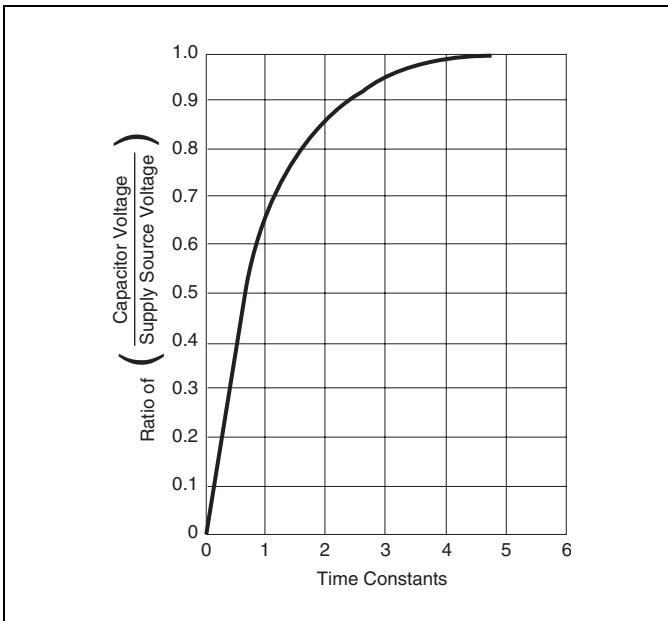

Figure AN1003.8 Capacitor Charging from DC Source

Usually, the design starting point is the selection of a capacitance value which will reliably trigger the thyristor when the capacitance is discharged. Trigger devices and thyristor gate triggering characteristics play a part in the selection. All the device characteristics are not always completely specified in applications, so experimental determination is sometimes needed.

Upon final selection of the capacitor, the curve shown in Figure AN1003.8 can be used in determining the charging resistance needed to obtain the desired control characteristics.

Many circuits begin each half-cycle with the capacitor voltage at or near zero. However, most circuits leave a relatively large residual voltage on the capacitor after discharge. Therefore, the charging resistor must be determined on the basis of additional charge necessary to raise the capacitor to trigger potential.

For example, assume that we want to trigger an S2010L SCR with a 32 V trigger diac. A 0.1 μF capacitor will supply the necessary SCR gate current with the trigger diac. Assume a 50 V dc power supply, 30° minimum conduction angle, and 150° maximum conduction angle with a 60 Hz input power source. At approximately 32 V, the diac triggers leaving 0.66 V_{BO} of diac voltage on the capacitor. In order for diac to trigger, 22 V must be added to the capacitor potential, and 40 V additional (50-10) are available. The capacitor must be charged to 22/40 or 0.55 of the available charging voltage in the desired time. Looking at Figure AN1003.8, 0.55 of charging voltage represents 0.8 time constant. The 30° conduction angle required that the firing pulse be delayed 150° or 6.92 ms. (The period of 1/2 cycle at 60 Hz is 8.33 ms.) To obtain this time delay:

$$6.92 \text{ ms} = 0.8 \text{ RC}$$

$$\text{RC} = 8.68 \text{ ms}$$

$$\text{if } C = 0.10 \text{ } \mu\text{F}$$

$$\text{then, } R = \frac{8.68 \times 10^{-3}}{0.1 \times 10^{-6}} = 86,000 \text{ } \Omega$$

To obtain the minimum R (150° conduction angle), the delay is 30° or

$$(30/180) \times 8.33 = 1.39 \text{ ms}$$

$$1.39 \text{ ms} = 0.8 \text{ RC}$$

$$\text{RC} = 1.74 \text{ ms}$$

$$R = \frac{1.74 \times 10^{-3}}{0.1 \times 10^{-6}} = 17,400 \text{ } \Omega$$

Using practical values, a 100 k potentiometer with up to 17 k minimum (residual) resistance should be used. Similar calculations using conduction angles between the maximum and minimum values will give control resistance versus power characteristic of this circuit.

Triac Phase Control

The basic full-wave triac phase control circuit shown in Figure AN1003.9 requires only four components. Adjustable resistor R₁ and C₁ are a single-element phase-shift network. When the voltage across C₁ reaches breakover voltage (V_{BO}) of the diac, C₁ is partially discharged by the diac into the triac gate. The triac is then triggered into the conduction mode for the remainder of that half-cycle. In this circuit, triggering is in Quadrants I and III. The unique simplicity of this circuit makes it suitable for applications with small control range.

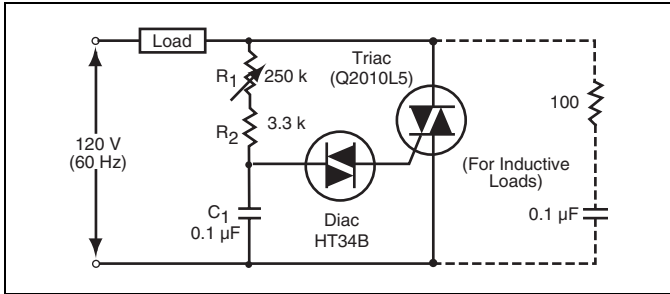

Figure AN1003.9 Basic Diac-Triac Phase Control

The hysteresis (snap back) effect is somewhat similar to the action of a kerosene lantern. That is, when the control knob is first rotated from the off condition, the lamp can be lit only at some intermediate level of brightness, similar to turning up the wick to light the lantern. Brightness can then be turned down until it finally reaches the extinguishing point. If this occurs, the lamp can only be relit by turning up the control knob again to the intermediate level. Figure AN1003.10 illustrates the hysteresis effect in capacitor-diac triggering. As R_1 is brought down from its maximum resistance, the voltage across the capacitor increases until the diac first fires at point A, at the end of a half-cycle (conduction angle θ_i). After the gate pulse, however, the capacitor voltage drops suddenly to about half the triggering voltage, giving the capacitor a different initial condition. The capacitor charges to the diac, triggering voltage at point B in the next half-cycle and giving a steady-state conduction angle shown as θ for the triac.

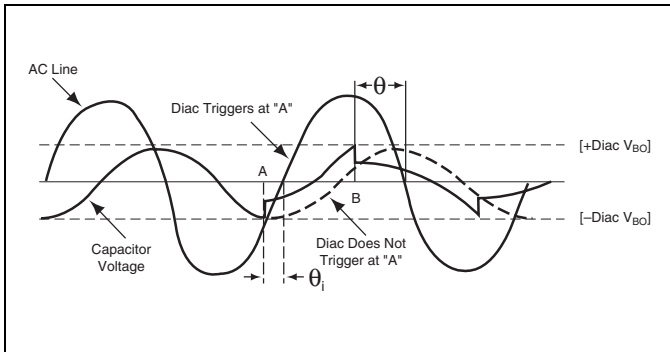

Figure AN1003.10 Relationship of AC Line Voltage and Triggering Voltage

In the Figure AN1003.11 illustration, the addition of a second RC phase-shift network extends the range on control and reduces the hysteresis effect to a negligible region. This circuit will control from 5% to 95% of full load power, but is subject to supply voltage variations. When R_1 is large, C_1 is charged primarily through R_3 from the phase-shifted voltage appearing across C_2 . This action provides additional range of phase-shift across C_1 and enables C_2 to partially recharge C_1 after the diac has triggered, thus reducing hysteresis. R_3 should be adjusted so that the circuit just drops out of hysteresis when R_1 is brought to maximum resistance.

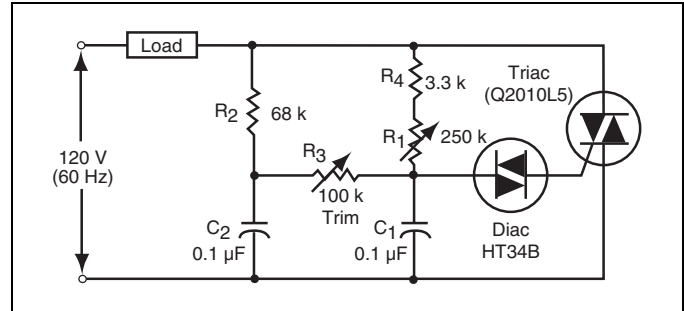

Figure AN1003.11 Extended Range Full-wave Phase Control

By using one of the circuits shown in Figure AN1003.12, the hysteresis effect can be eliminated entirely. The circuit (a) resets the timing capacitor to the same level after each positive half-cycle, providing a uniform initial condition for the timing capacitor. This circuit is useful only for resistive loads since the firing angle is not symmetrical throughout the range. If symmetrical firing is required, use the circuit (b) shown in Figure AN1003.12.

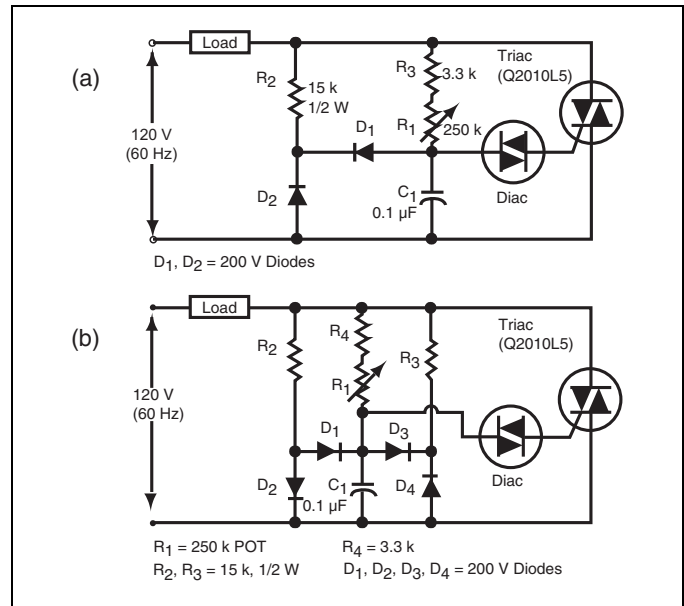

Figure AN1003.12 Wide-range Hysteresis Free Phase Control

For more complex control functions, particularly closed loop controls, the unijunction transistor may be used for the triggering device in a ramp and pedestal type of firing circuit as shown in Figure AN1003.13.

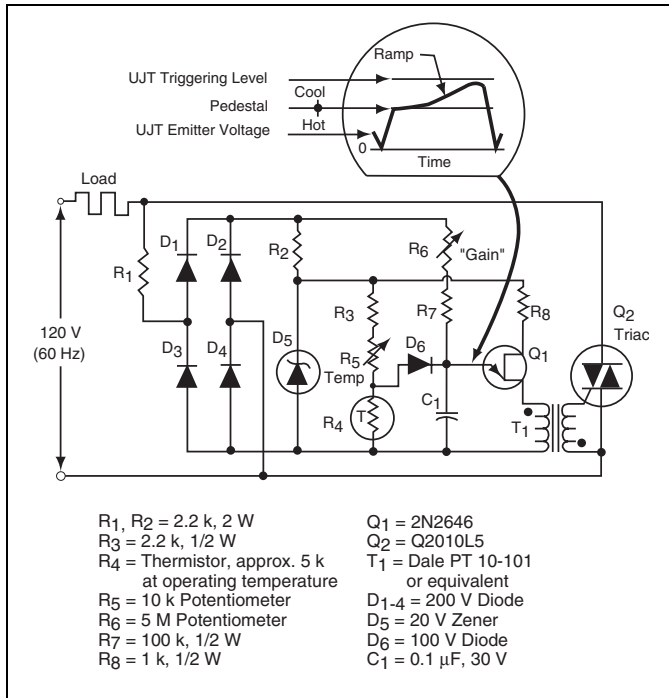

Figure AN1003.13 Precision Proportional Temperature Control

Several speed control and light dimming (phase) control circuits have been presented that give details for a complete 120 V application circuit but none for 240 V. Figure AN1003.14 and Figure AN1003.15 show some standard phase control circuits for 240 V, 60 Hz/50 Hz operation along with 120 V values for comparison. Even though there is very little difference, there are a few key things that must be remembered. First, capacitors and triacs connected across the 240 V line must be rated at 400 V. Secondly, the potentiometer (variable resistor) value must change considerably to obtain the proper timing or triggering for 180° in each half-cycle.

Figure AN1003.14 shows a simple single-time-constant light dimmer (phase control) circuit, giving values for both 120 V and 240 V operation.

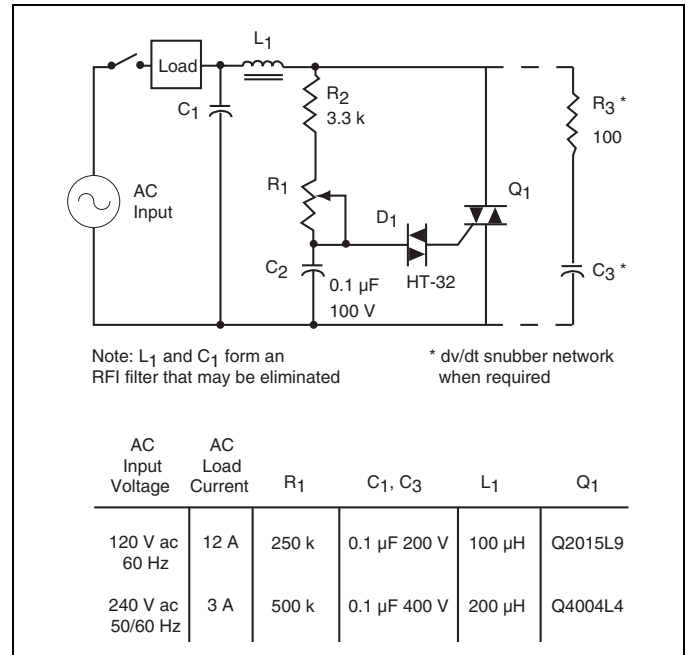

Figure AN1003.14 Single-time-constant Circuit for Incandescent Light Dimming, Heat Control, and Motor Speed Control

The circuit shown in Figure AN1003.15 is a double-time-constant circuit which has improved performance compared to the circuit shown in Figure AN1003.14. This circuit uses an additional RC network to extend the phase angle so that the triac can be triggered at small conduction angles. The additional RC network also minimizes any hysteresis effect explained and illustrated in Figure AN1003.10 and Figure AN1003.11.

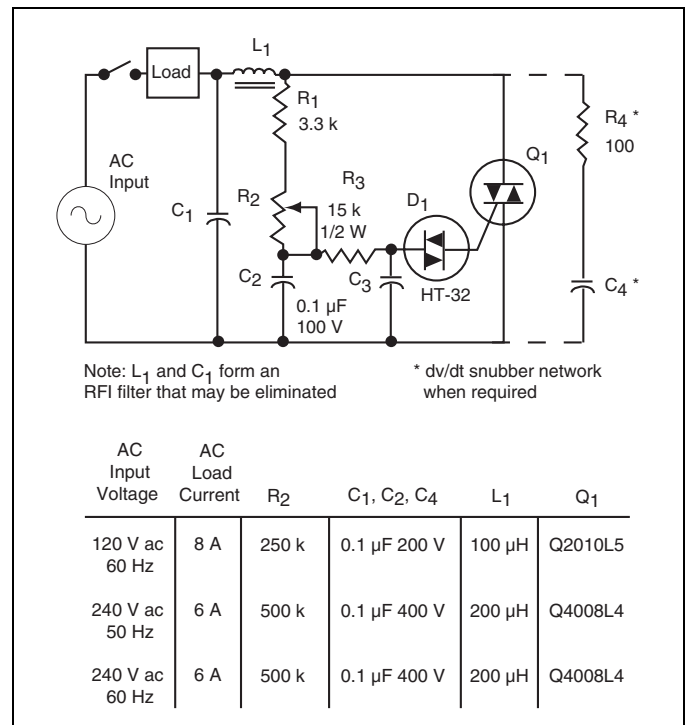

Figure AN1003.15 Double-time-constant Circuit for Incandescent Light Dimming, Heat Control, and Motor Speed Control

Permanent Magnet Motor Control

Figure AN1003.16 illustrates a circuit for phase controlling a permanent magnet (PM) motor. Since PM motors are also generators, they have characteristics that make them difficult for a standard triac to commute properly. Control of a PM motor is easily accomplished by using an alternistor triac with enhanced commutating characteristics.

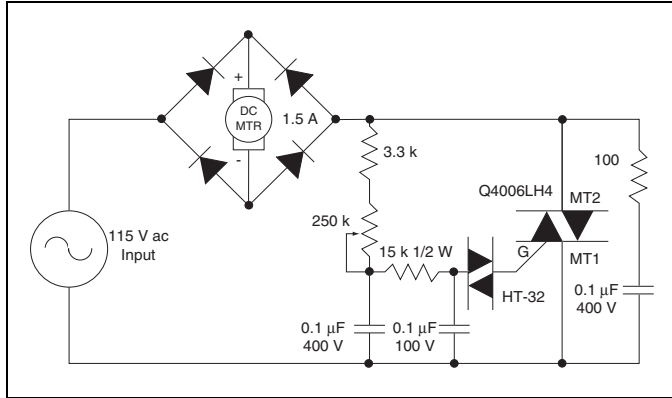

Figure AN1003.16 Circuit for Phase Controlling a Permanent Magnet Motor

PM motors normally require full-wave DC rectification. Therefore, the alternistor triac controller should be connected in series with the AC input side of the rectifier bridge. The possible alternative of putting an SCR controller in series with the motor on the DC side of the rectifier bridge can be a challenge when it comes to timing and delayed turn-on near the end of the half cycle. The alternistor triac controller shown in Figure AN1003.16 offers a wide range control so that the alternistor triac can be triggered at a small conduction angle or low motor speed; the rectifiers and alternistors should have similar voltage ratings, with all based on line voltage and actual motor load requirements.

SCR Phase Control

Figure AN1003.17 shows a very simple variable resistance half-wave circuit. It provides phase retard from essentially zero (SCR full on) to 90 electrical degrees of the anode voltage wave (SCR half on). Diode CR₁ blocks reverse gate voltage on the negative half-cycle of anode supply voltage. This protects the reverse gate junction of sensitive SCRs and keeps power dissipation low for gate resistors on the negative half cycle. The diode is rated to block at least the peak value of the AC supply voltage. The retard angle cannot be extended beyond the 90-degree point because the trigger circuit supply voltage and the trigger voltage producing the gate current to fire are in phase. At the peak of the AC supply voltage, the SCR can still be triggered with the maximum value of resistance between anode and gate. Since the SCR will trigger and latch into conduction the first time I_{GT} is reached, its conduction cannot be delayed beyond 90 electrical degrees with this circuit.

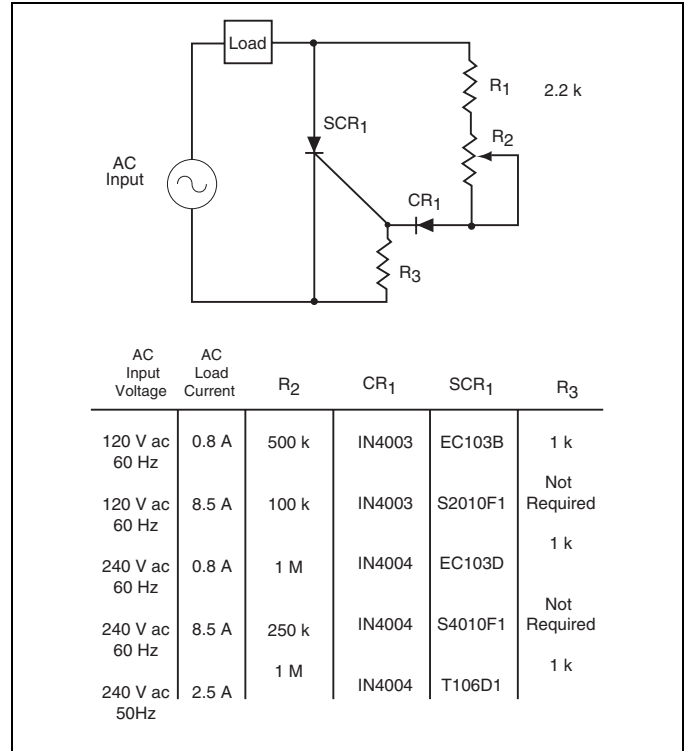

Figure AN1003.17 Half-wave Control, 0° to 90° Conduction

Figure AN1003.18 shows a half-wave phase control circuit using an SCR to control a universal motor. This circuit is better than simple resistance firing circuits because the phase-shifting characteristics of the RC network permit the firing of the SCR beyond the peak of the impressed voltage, resulting in small conduction angles and very slow speed.

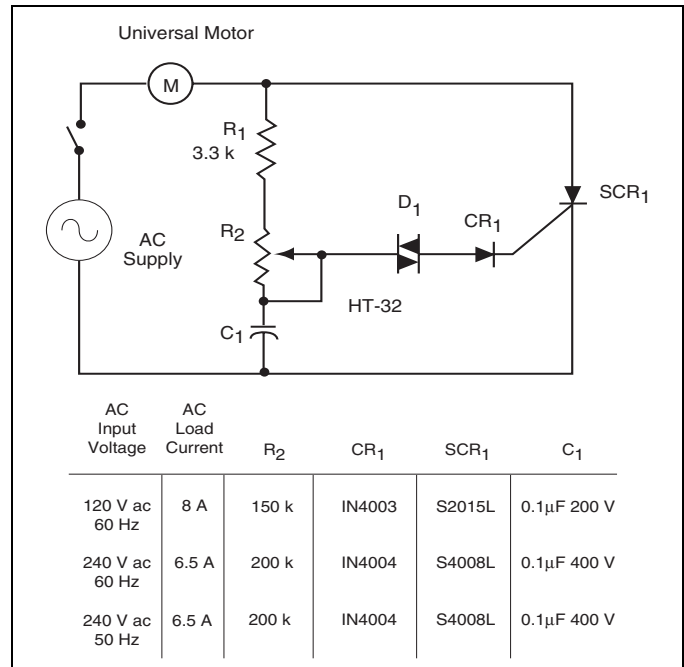

Figure AN1003.18 Half-wave Motor Control

Phase Control from Logic (DC) Inputs

Triacs can also be phase-controlled from pulsed DC unidirectional inputs such as those produced by a digital logic control system. Therefore, a microprocessor can be interfaced to AC load by using a sensitive gate triac to control a lamp's intensity or a motor's speed.

There are two ways to interface the unidirectional logic pulse to control a triac. Figure AN1003.19 illustrates one easy way if load current is approximately 5 A or less. The sensitive gate triac serves as a direct power switch controlled by HTL, TTL, CMOS, or integrated circuit operational amplifier. A timed pulse from the system's logic can activate the triac anywhere in the AC sine-wave producing a phase-controlled load.

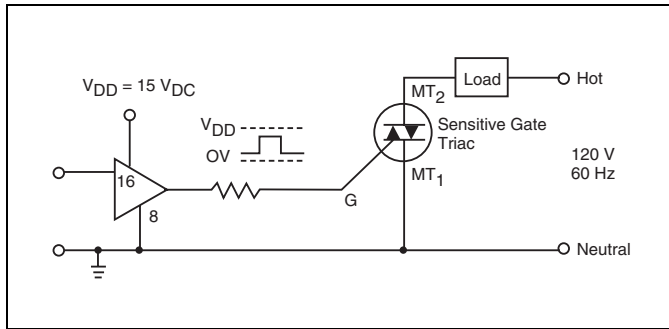

Figure AN1003.19 Sensitive Gate Triac Operating in Quadrants I and IV

The key to DC pulse control is correct grounding for DC and AC supply. As shown in Figure AN1003.19, **DC ground and AC ground/neutral must be common plus MT1 must be connected to common ground.** MT1 of the triac is the return for both main terminal junctions as well as the gate junction.

Figure AN1003.20 shows an example of a unidirectional (all negative) pulse furnished from a special I.C. that is available from LSI Computer Systems in Melville, New York. Even though the circuit and load is shown to control a Halogen lamp, it could be applied to a common incandescent lamp for touch-controlled dimming.

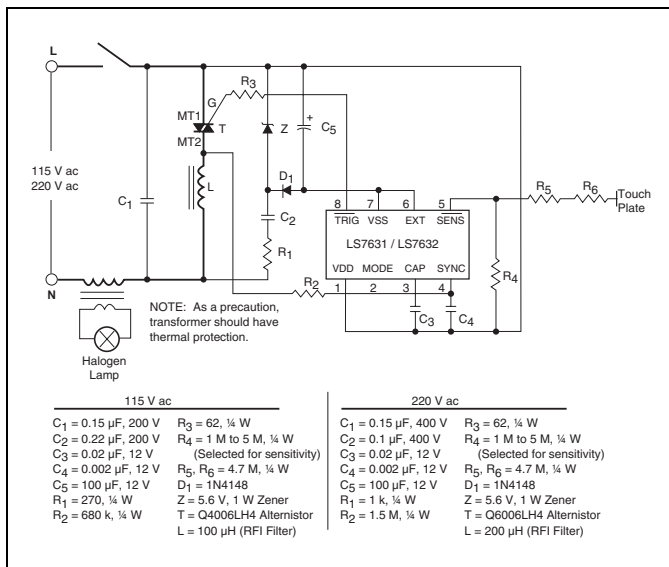

Figure AN1003.20 Typical Touch Plate Halogen Lamp Dimmer

For a circuit to control a heavy-duty inductive load where an alternistor is not compatible or available, two SCRs can be driven by an inexpensive TO-92 triac to make a very high current triac or alternistor equivalent, as shown in Figure AN1003.21. See "Relationship of IAV, IRMS, and IPK" in AN1009 for design calculations.

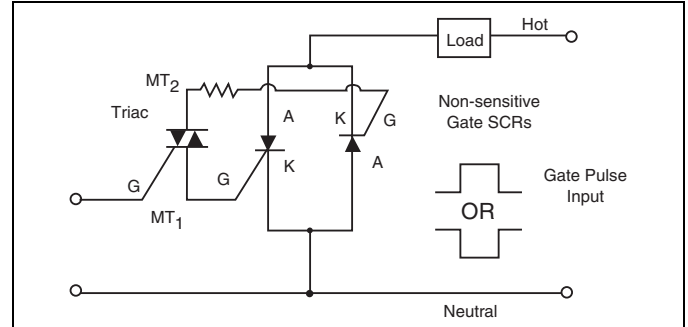

Figure AN1003.21 Triac Driving Two Inverse Parallel Non-Sensitive Gate SCRs

Figure AN1003.22 shows another way to interface a unidirectional pulse signal and activate AC loads at various points in the AC sine wave. This circuit has an electrically-isolated input which allows load placement to be flexible with respect to AC line. In other words, connection between DC ground and AC neutral is not required.

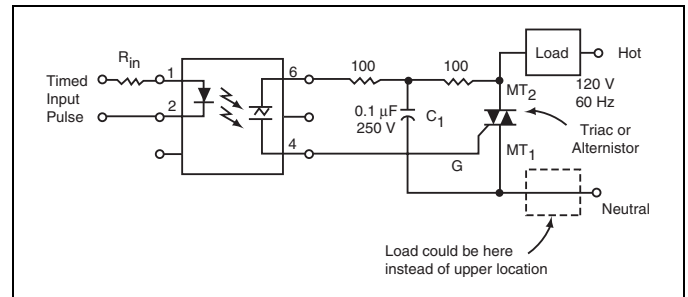

Figure AN1003.22 Opto-isolator Driving a Triac or Alternistor

Microcontroller Phase Control

Traditionally, microcontrollers were too large and expensive to be used in small consumer applications such as a light dimmer. Microchip Technology Inc. of Chandler, Arizona has developed a line of 8-pin microcontrollers without sacrificing the functionality of their larger counterparts. These devices do not provide high drive outputs, but when combined with a sensitive triac can be used in a cost-effective light dimmer.

Figure AN1003.23 illustrates a simple circuit using a transformer-less power supply, PIC 12C508 microcontroller, and a sensitive triac configured to provide a light dimmer control. R₃ is connected to the hot lead of the AC power line and to pin GP₄. The ESD protection diodes of the input structure allow this connection without damage. When the voltage on the AC power line is positive, the protection diode from the input to V_{DD} is forward biased, and the input buffer will see approximately V_{DD} + 0.7 V. The software will read this pin as high. When the voltage on the line is negative, the protection diode from V_{SS} to the input pin is forward biased, and the input buffer sees approximately V_{SS} - 0.7 V. The software will read the pin as low. By polling GP₄ for a change in state, the software can detect zero crossing.

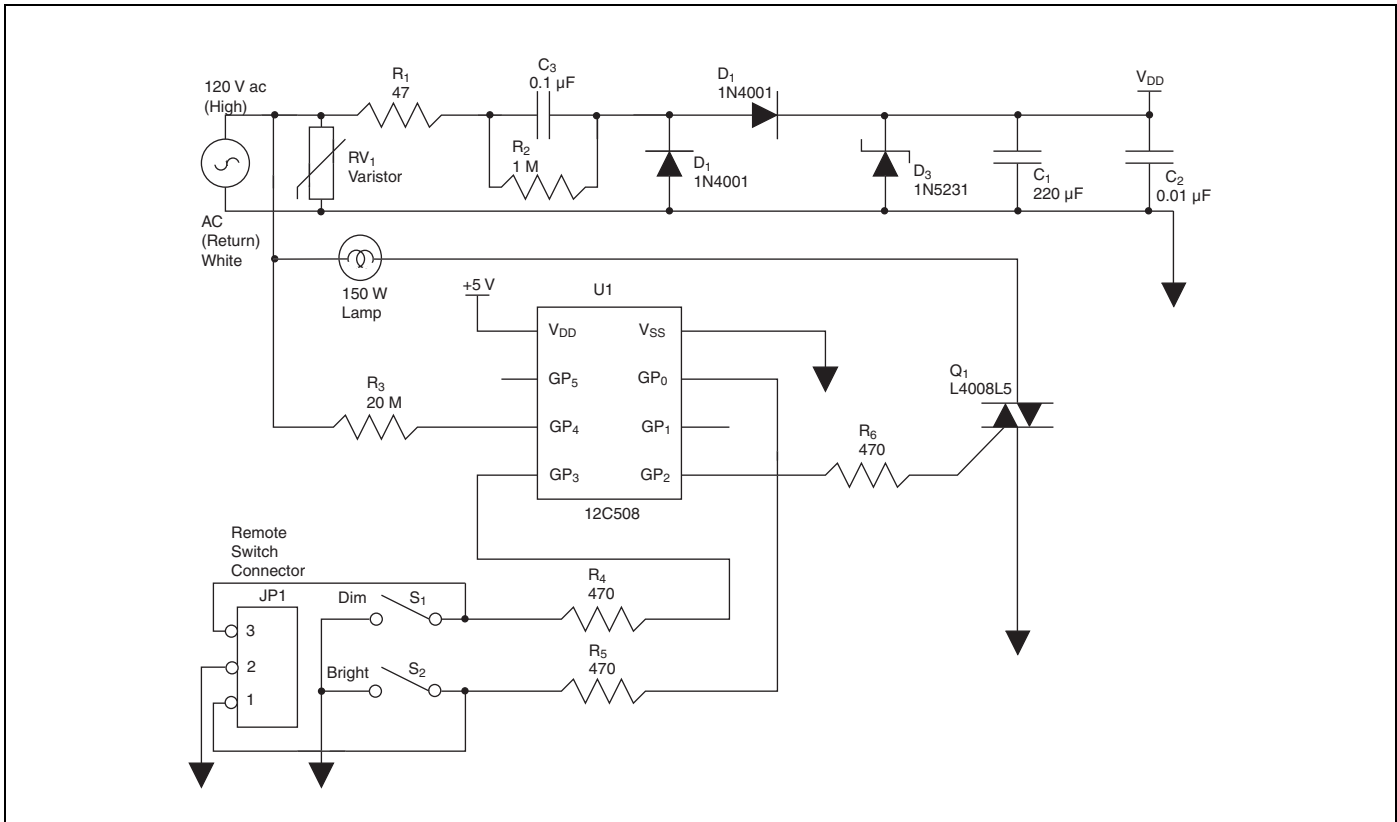

Figure AN1003.23 Microcontroller Light Dimmer Control

With a zero crossing state detected, software can be written to turn on the triac by going from tri-state to a logic high on the gate and be synchronized with the AC phase cycles (Quadrants I and IV). Using pull-down switches connected to the microcontroller inputs, the user can signal the software to adjust the duty cycle of the triac.

For higher amperage loads, a small 0.8 A, TO-92 triac (operating in Quadrants I and IV) can be used to drive a 25 A alternistor triac (operating in Quadrants I and III) as shown in the heater control illustration in Figure AN1003.24.

For a complete listing of the software used to control this circuit, see the Microchip application note PICREF-4. This application note can be downloaded from Microchip's Web site at www.microchip.com.

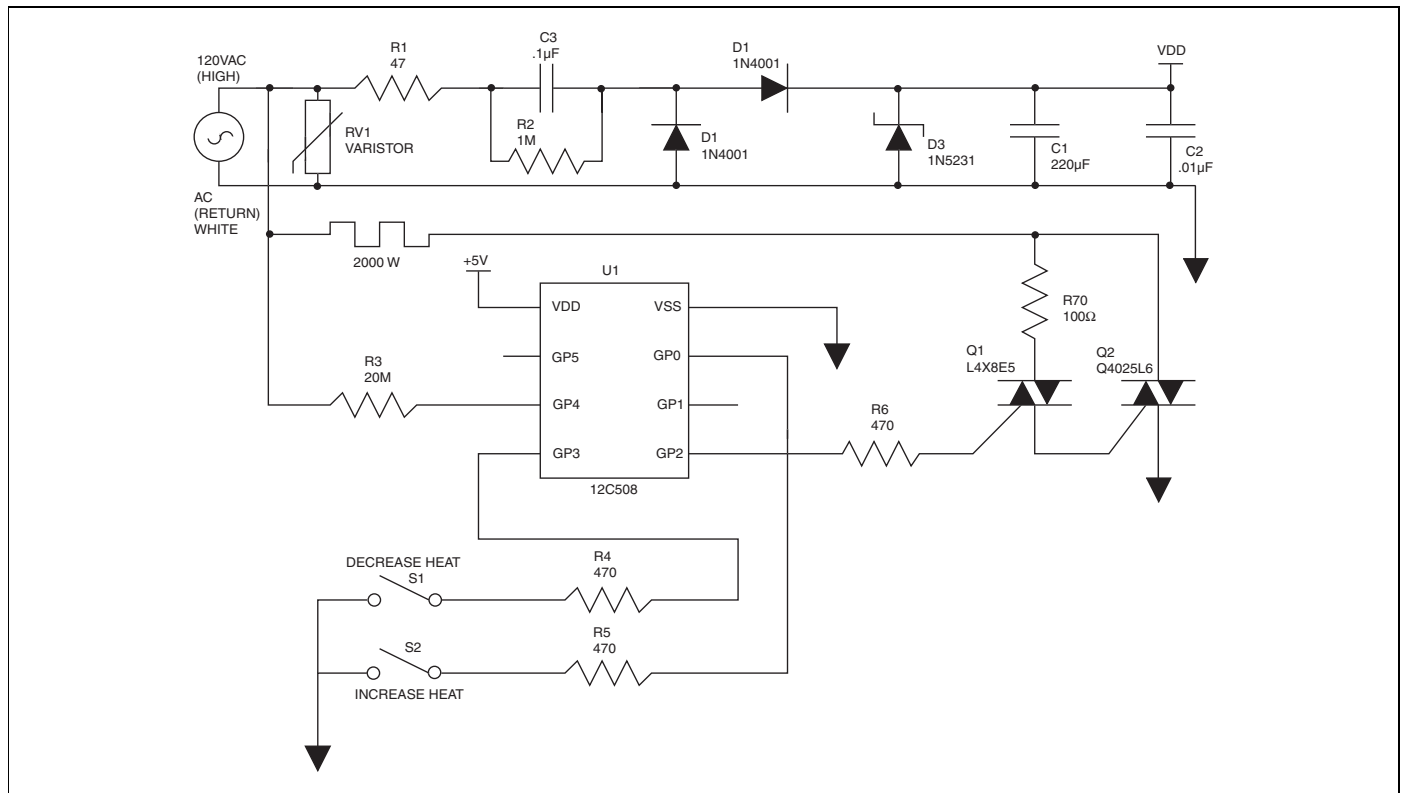

Figure AN1003.24 Microcontroller Heater Control

Summary

The load currents chosen for the examples in this application note were strictly arbitrary, and the component values will be the same regardless of load current except for the power triac or SCR. The voltage rating of the power thyristor devices must be a minimum of 200 V for 120 V input voltage and 400 V for 240 V input voltage.

The use of alternistors instead of triacs may be much more acceptable in higher current applications and may eliminate the need for any dv/dt snubber network.

For many electrical products in the consumer market, competitive thyristor prices and simplified circuits make automatic control a possibility. These simple circuits give the designer a good feel for the nature of thyristor circuits and their design. More sophistication, such as speed and temperature feedback, can be developed as the control techniques become more familiar. A remarkable phenomenon is the degree of control obtainable with very simple circuits using thyristors. As a result, industrial and consumer products will greatly benefit both in usability and marketability.

Notes

Mounting and Handling of Semiconductor Devices

Introduction

Proper mounting and handling of semiconductor devices, particularly those used in power applications, is an important, yet sometimes overlooked, consideration in the assembly of electronic systems. Power devices need adequate heat dissipation to increase operating life and reliability and allow the device to operate within manufacturers' specifications. Also, in order to avoid damage to the semiconductor chip or internal assembly, the devices should not be abused during assembly. Very often, device failures can be attributed directly to a heat sinking or assembly damage problem.

The information in this application note guides the semiconductor user in the proper use of Teccor devices, particularly the popular and versatile TO-220 and TO-202 epoxy packages.

Contact the Teccor Applications Engineering Group for further details or suggestions on use of Teccor devices.

Lead Forming — Typical Configurations

A variety of mounting configurations are possible with Teccor power semiconductor TO-202, TO-92, DO-15X, and TO-220 packages, depending upon such factors as power requirements, heat sinking, available space, and cost considerations. Figure AN1004.1 shows typical examples and basic design rules.

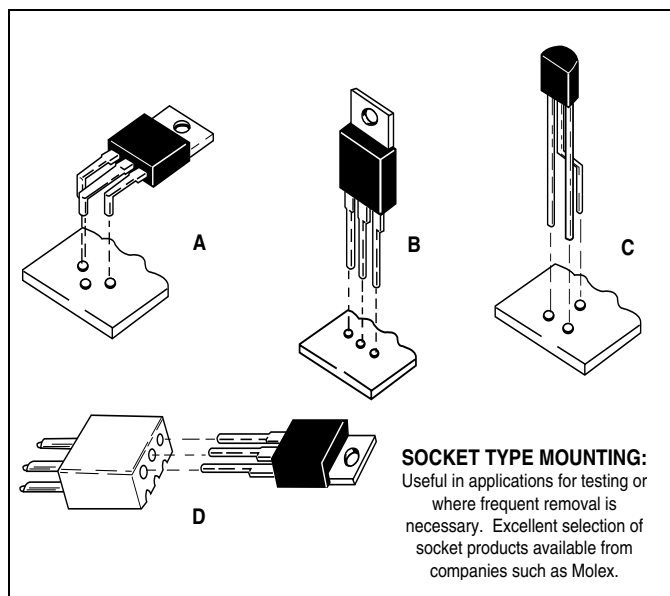

Figure AN1004.1 Component Mounting

These are suitable only for vibration-free environments and low-power, free-air applications. For best results, the device should be in a vertical position for maximum heat dissipation from convection currents.

Standard Lead Forms

Teccor encourages users to allow factory production of all lead and tab form options. Teccor has the automated machinery and expertise to produce pre-formed parts at minimum risk to the device and with greater convenience for the consumer. See the "Lead Form Dimensions" section of this catalog for a complete list of readily available lead form options. Contact Teccor for information regarding custom lead form designs.

Lead Bending Method

Leads may be bent easily and to any desired angle, provided that the bend is made at a minimum 0.063" (0.1" for TO-218 package) away from the package body with a minimum radius of 0.032" (0.040" for TO-218 package) or 1.5 times lead thickness rule. DO-15X device leads may be bent with a minimum radius of 0.050", and DO-35 device leads may be bent with a minimum radius of 0.028". Leads should be held firmly between the package body and the bend so that strain on the leads is not transmitted to the package body, as shown in Figure AN1004.2. Also, leads should be held firmly when trimming length.

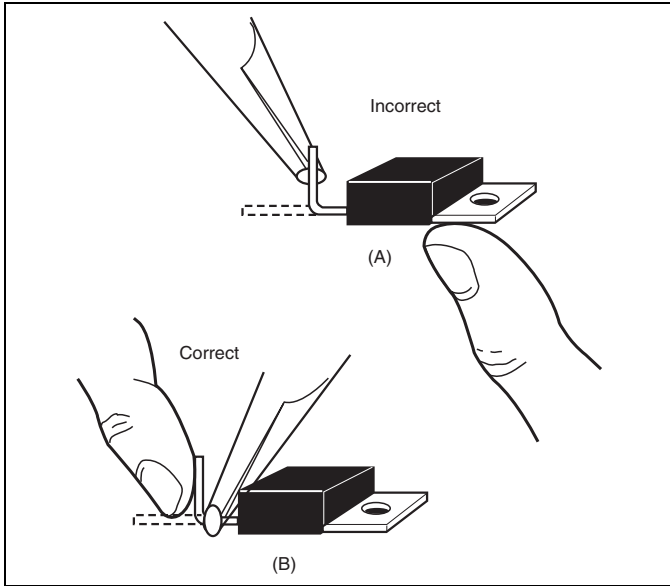

Figure AN1004.2 Lead Bending Method

When bending leads in the plane of the leads (spreading), bend only the narrow part. Sharp angle bends should be done only once as repetitive bending will fatigue and break the leads.

The mounting tab of the TO-202 package may also be bent or formed into any convenient shape as long as it is held firmly between the plastic case and the area to be formed or bent. Without this precaution, bending the tab may fracture the chip and permanently damage the unit.

Heat Sinking

Use of the largest, most efficient heat sink as is practical and cost effective extends device life and increases reliability. In the illustration shown in Figure AN1004.3, each device is electrically isolated.

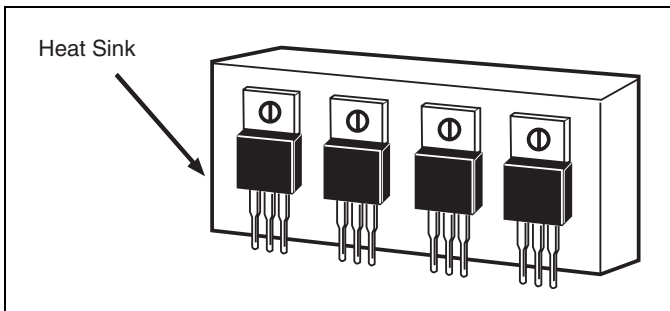

Figure AN1004.3 Several Isolated TO-220 Devices Mounted to a Common Heat Sink

Many power device failures are a direct result of improper heat dissipation. Heat sinks with a mating area smaller than the metal tab of the device are unacceptable. Heat sinking material should be at least 0.062" thick to be effective and efficient.

Note that in all applications the maximum case temperature (T_C) rating of the device must not be exceeded. Refer to the individual device data sheet rating curves (T_C versus I_T) as well as the individual device outline drawings for correct T_C measurement point.

Figure AN1004.4 through Figure AN1004.6 show additional examples of acceptable heat sinks.

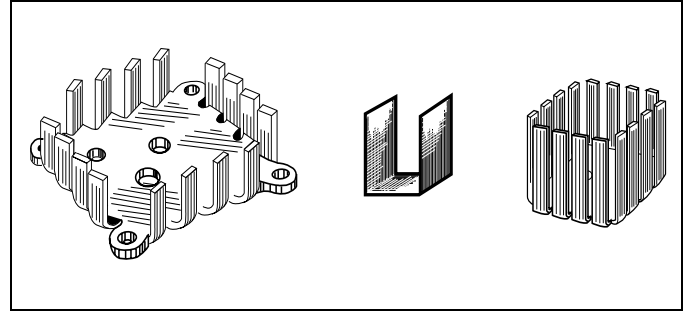

Figure AN1004.4 Examples of PC Board Mounts

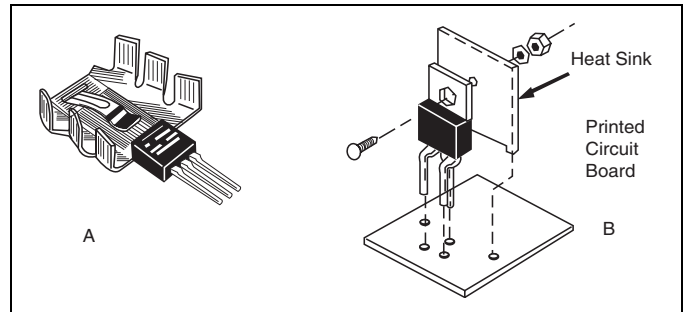

Figure AN1004.5 Vertical Mount Heat Sink

Several types of vertical mount heat sinks are available. Keep heat sink vertical for maximum convection.

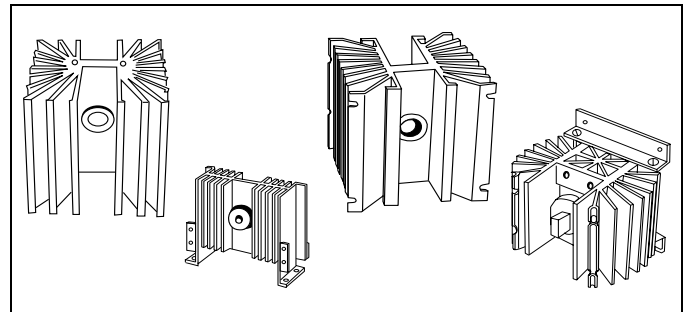

Figure AN1004.6 Examples of Extruded Aluminum

When coupled with fans, extruded aluminum mounts have the highest efficiency.

Heat Sinking Notes

Care should be taken not to mount heat sinks near other heat-producing elements such as power resistors, because black anodized heat sinks may absorb more heat than they dissipate.

Some heat sinks can hold several power devices. Make sure that if they are in electrical contact to the heat sink, the devices do not short-circuit the desired functions. Isolate the devices electrically or move to another location. Recall that the mounting tab of Teccor isolated TO-220 devices is electrically isolated so that several devices may be mounted on the same heat sink without extra insulating components. If using an external insulator such as mica, with a thickness of 0.004", an additional thermal resistance of 0.8° C/W for TO-220 or 0.5° C/W for TO-218 devices is added to the $R_{\theta JC}$ device rating.

Allow for adequate ventilation. If possible, route heat sinks to outside of assembly for maximum airflow.

Mounting Surface Selection

Proper mounting surface selection is essential to efficient transfer of heat from the semiconductor device to the heat sink and from the heat sink to the ambient. The most popular heat sinks are flat aluminum plates or finned extruded aluminum heat sinks.

The mounting surface should be clean and free from burrs or scratches. It should be flat within 0.002 inch per inch, and a surface finish of 30 to 60 microinches is acceptable. Surfaces with a higher degree of polish do not produce better thermal conductivity.

Many aluminum heat sinks are black anodized to improve thermal emissivity and prevent corrosion. Anodizing results in high electrical but negligible thermal insulation. This is an excellent choice for isolated TO-220 devices. For applications of TO-202 devices where electrical connection to the common anode tab is required, the anodization should be removed. Iridite or chromate acid dip finish offers low electrical and thermal resistance. Either TO-202 or isolated TO-220 devices may be mounted directly to this surface, regardless of application. Both finishes should be cleaned prior to use to remove manufacturing oils and films. Some of the more economical heat sinks are painted black. Due to the high thermal resistance of paint, the paint should be removed in the area where the semiconductor is attached.

Bare aluminum should be buffed with #000 steel wool and followed with an acetone or alcohol rinse. Immediately, thermal grease should be applied to the surface and the device mounted down to prevent dust or metal particles from lodging in the critical interface area.

For good thermal contact, the use of thermal grease is essential to fill the air pockets between the semiconductor and the mounting surface. This decreases the thermal resistance by 20%. For example, a typical TO-220 with $R_{\theta JC}$ of 1.2 °C/W may be lowered to 1 °C/W by using thermal grease.

Teccor recommends Dow-Corning 340 as a proven effective thermal grease. Fibrous applicators are not recommended as they may tend to leave lint or dust in the interface area. Ensure that the grease is spread adequately across the device mounting surface, and torque down the device to specification.

Contact Teccor Applications Engineering for assistance in choosing and using the proper heat sink for specific application.

Hardware And Methods

TO-220

The mounting hole for the Teccor TO-220 devices should not exceed 0.140" (6/32) clearance. (Figure AN1004.7) No insulating bushings are needed for the L Package (isolated) devices as the tab is electrically isolated from the semiconductor chip. 6/32 mounting hardware, especially round head or Fillister machine screws, is recommended and should be torqued to a value of 6 inch-lbs.

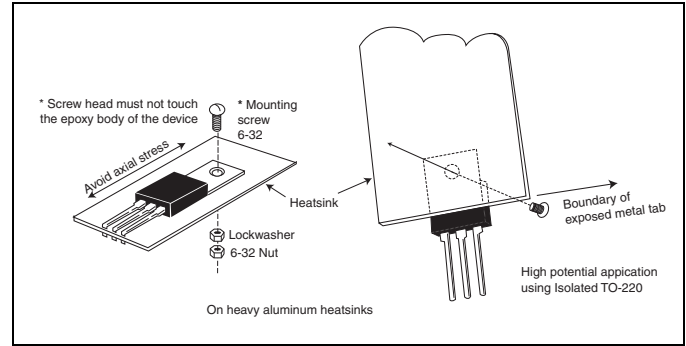

Figure AN1004.7 TO-220 Mounting

Punched holes are not acceptable due to cratering around the hole which can cause the device to be pulled into the crater by the fastener or can leave a significant portion of the device out of contact with the heat sink. The first effect may cause immediate damage to the package and early failure, while the second can create higher operating temperatures which will shorten operating life. Punched holes are quite acceptable in thin metal plates where fine-edge blanking or sheared-through holes are employed.

Drilled holes must have a properly prepared surface. Excessive chamfering is not acceptable as it may create a crater effect. Edges must be deburred to promote good contact and avoid puncturing isolation materials.

For high-voltage applications, it is recommended that only the metal portion of the TO-220 package (as viewed from the bottom of the package) be in contact with the heat sink. This will provide maximum oversurface distance and prevent a high voltage path over the plastic case to a grounded heat sink.

TO-202

The mounting hole for the Teccor TO-202 devices should not exceed 0.112" (4/40) clearance. (Figure AN1004.8) Since tab is electrically common with anode, heat sink may or may not need to be electrically isolated from tab. If not, use 4/40 screw with lock washer and nut. Mounting torque is 6 inch-lbs.

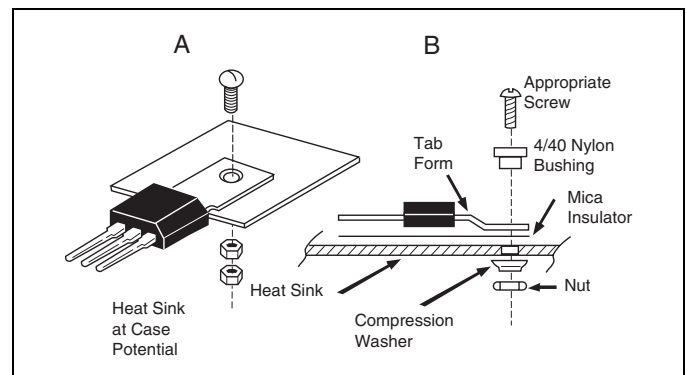

Figure AN1004.8 TO-202 Mounting

A nylon bushing and mica insulation are required to insulate the tab in an isolated application. A compression washer is recommended to avoid damage to the bushing. Do not attempt to mount non-formed tabs to a plane surface, as the resulting strain on the case may cause it or the semiconductor chip assembly to fail. Teccor has the facilities and expertise to properly tab form TO-202 devices for the convenience of the consumer.

TO-218

The mounting hole for the TO-218 device should not exceed 0.164" (8/32) clearance. Isolated versions of TO-218 do not require any insulating material since mounting tab is electrically isolated from the semiconductor chip. Round lead or Fillister machine screws are recommended. Maximum torque to be applied to mounting tab should not exceed 8 inch-lbs.

The same precautions given for the TO-220 package concerning punched holes, drilled holes, and proper prepared heat sink mounting surface apply to the TO-218 package. Also for high-voltage applications, it is recommended that only the metal portion of the mounting surface of the TO-218 package be in contact with heat sink. This achieves maximum oversurface distance to prevent a high-voltage path over the device body to grounded heat sink.

General Mounting Notes

Care must be taken on both packages at all times to avoid strain to the tab or leads. For easy insertion of the part onto the board or heat sink, avoid axial strain on the leads. Carefully measure mounting holes for the tab and the leads, and do any forming of the tab or leads before mounting. Refer to the "Lead Form Dimensions" section of this catalog before attempting lead form operations.

Rivets may be used for less demanding and more economical applications. 1/8" all-aluminum pop rivets can be used on both TO-220 and TO-202 packages. Use a 0.129"-0.133" (#30) drill for the hole and insert the rivet from the top side, as shown in Figure AN1004.9. An insertion tool, similar to a "USM" PRG 430 hand riveter, is recommended. A wide selection of grip ranges is available, depending upon the thickness of the heat sink material. Use an appropriate grip range to securely anchor the device, yet not deform the mounting tab. The recommended rivet tool has a protruding nipple that will allow easy insertion of the rivet and keep the tool clear of the plastic case of the device.

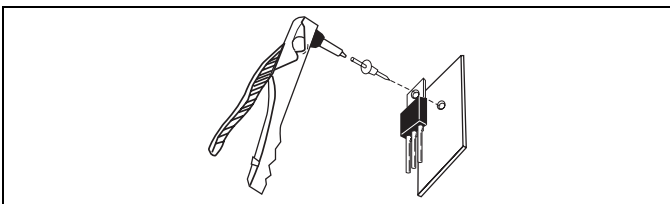

Figure AN1004.9 Pop Riveting Technique

A Milford #511 (Milford Group, Milford, CT) semi-tubular steel rivet set into a 0.129" receiving hole with a riveting machine similar to a Milford S256 is also acceptable. Contact the rivet machine manufacturer for exact details on application and set-up for optimum results.

Pneumatic or other impact riveting devices are not recommended due to the shock they may apply to the device.

Under no circumstance should any tool or hardware come into contact with the case. The case should not be used as a brace for any rotation or shearing force during mounting or in use. Non-standard size screws, nuts, and rivets are easily obtainable to avoid clearance problems.

Always use an accurate torque wrench to mount devices. No gain is achieved by overtightening devices. In fact, overtightening may cause the tab and case to deform or rupture, seriously damaging

the device. The curve shown in Figure AN1004.10 illustrates the effect of proper torque.

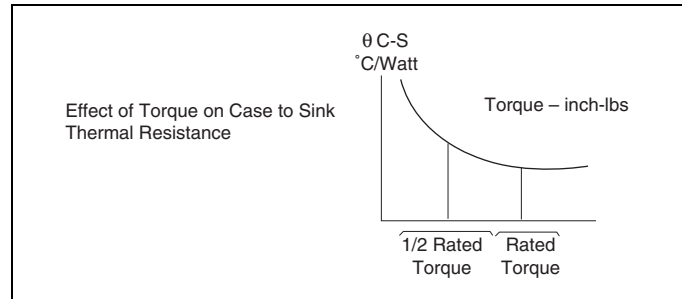

Figure AN1004.10 Effect of Torque to Sink Thermal Resistance

With proper care, the mounting tab of a device can be soldered to a surface. However, the heat required to accomplish this operation can damage or destroy the semiconductor chip or internal assembly. See "Surface Mount Soldering Recommendations" (AN1005) in this catalog.

Spring-steel clips can be used to replace torqued hardware in assembling thyristors to heat sinks. Clips snap into heat sink slots to hold the device in place for PC board insertion. Clips are available in several sizes for various heat sink thicknesses and thyristor case styles from *Aavid Thermalloy* in Concord, New Hampshire. A typical heatsink is shown in Figure AN1004.11

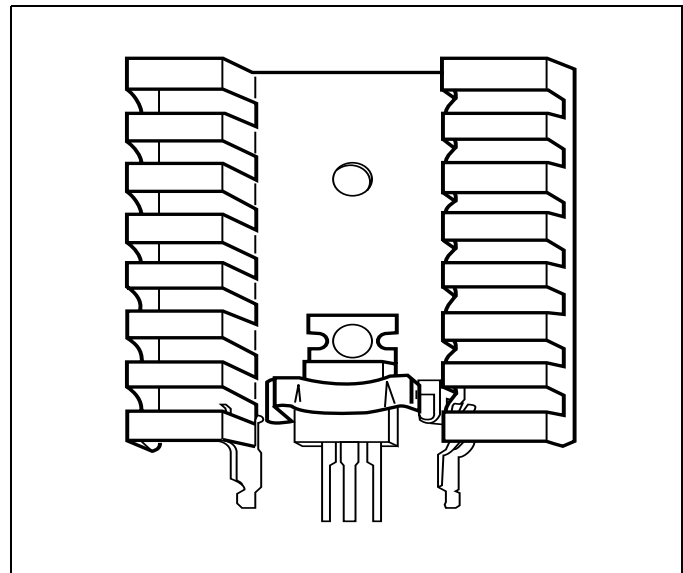

Figure AN1004.11 Typical Heat Sink Using Clips

Soldering Of Leads

A prime consideration in soldering leads is the soldering of device leads into PC boards, heat sinks, and so on. Significant damage can be done to the device through improper soldering. In any soldering process, do not exceed the data sheet lead solder temperature of +230 °C for 10 seconds, maximum, $\geq 1/16$ " from the case.

This application note presents details about the following three types of soldering:

- Hand soldering
- Wave soldering
- Dip soldering

Hand Soldering

This method is mostly used in prototype breadboarding applications and production of small modules. It has the greatest potential for misuse. The following recommendations apply to Teccor TO-92, TO-202, TO-220, and TO-218 packages.

Select a small- to medium-duty electric soldering iron of 25 W to 45 W designed for electrical assembly application. Tip temperature should be rated from 600 °F to 800 °F (300 °C to 425 °C). The iron should have sufficient heat capacity to heat the joint quickly and efficiently in order to minimize contact time to the part. Pencil tip probes work very well. Neither heavy-duty electrical irons of greater than 45 W nor flame-heated irons and large heavy tips are recommended, as the tip temperatures are far too high and uncontrollable and can easily exceed the time-temperature limit of the part.

Teccor Fastpak devices require a different soldering technique. Circuit connection can be done by either quick-connect terminals or solder.

Since most quick-connect 0.250" female terminals have a maximum rating of 30 A, connection to terminals should be made by soldering wires instead of quick-connects.

Recommended wire is 10 AWG stranded wire for use with MT1 and MT2 for load currents above 30 A. Soldering should be performed with a 100-watt soldering iron. The iron should not remain in contact with the wire and terminal longer than 40 seconds so the Fastpak triac is not damaged.

For the Teccor TO-218X package, the basic rules for hand soldering apply; however, a larger iron may be required to apply sufficient heat to the larger leads to efficiently solder the joint.

Remember not to exceed the lead solder temperatures of +230 °C for 10 seconds, maximum, $\geq 1/16$ " (1.59mm) from the case.

A 60/40 or 63/37 Sn/Pb solder is acceptable. This low melting-point solder, used in conjunction with a mildly activated rosin flux, is recommended.

Insert the device into the PC board and, if required, attach the device to the heat sink before soldering. Each lead should be individually heat sinked as it is soldered. Commercially available heat sink clips are excellent for this use. Hemostats may also be used if available. Needle-nose pliers are a good heat sink choice; however, they are not as handy as stand-alone type clips.

In any case, the lead should be clipped or grasped between the solder joint and the case, as near to the joint as possible. Avoid straining or twisting the lead in any way.

Use a clean pre-tinned iron, and solder the joint as quickly as possible. Avoid overheating the joint or bringing the iron or solder into contact with other leads that are not heat sinked.

Wave Solder

Wave soldering is one of the most efficient methods of soldering large numbers of PC boards quickly and effectively. Guidelines for soldering by this method are supplied by equipment manufacturers. The boards should be pre-heated to avoid thermal shock to semiconductor components, and the time-temperature cycle in the solder wave should be regulated to avoid heating the device beyond the recommended temperature rating. A mildly activated resin flux is recommended. Figure AN1004.12 shows typical heat and time conditions.

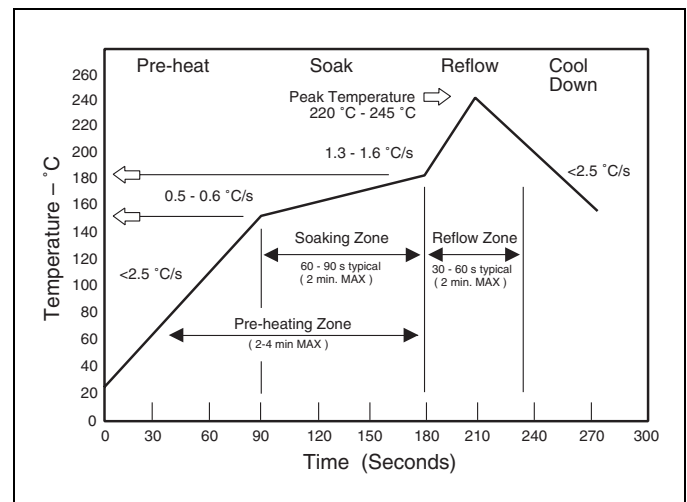

Figure AN1004.12 Reflow Soldering with Pre-heating

Dip Soldering

Dip soldering is very similar to wave soldering, but it is a hand operation. Follow the same considerations as for wave soldering, particularly the time-temperature cycle which may become operator dependent because of the wide process variations that may occur. This method is not recommended.

Board or device clean-up is left to the discretion of the customer. Teccor devices are tolerant of a wide variety of solvents, and they conform to MIL-STD 202E method 215 "Resistance to Solvents."

Notes

Surface Mount Soldering Recommendations

Introduction

The most important consideration in reliability is achieving a good solder bond between surface mount device (SMD) and substrate since the solder provides the thermal path from the chip. A good bond is less subject to thermal fatiguing and will result in improved device reliability.

The most economic method of soldering is a process in which all different components are soldered simultaneously, such as DO-214, Compak, TO-252 devices, capacitors, and resistors.

Reflow Of Soldering

The preferred technique for mounting microminiature components on hybrid thick- and thin-film is reflow soldering.

The DO-214 is designed to be mounted directly to or on thick-film metallization which has been screened and fired on a substrate. The recommended substrates are Alumina or P.C. Board material.

Recommended metallization is silver palladium or molybdenum (plated with nickel or other elements to enhance solderability). For more information, consult Du Pont's Thick-Film handbook or the factory.

It is best to prepare the substrate by either dipping it in a solder bath or by screen printing a solder paste.

After the substrate is prepared, devices are put in place with vacuum pencils. The device may be laid in place without special alignment procedures since it is self-aligning during the solder reflow process and will be held in place by surface tension.

For reliable connections, keep the following in mind:

- (1) Maximum temperature of the leads or tab during the soldering cycle does not exceed 275 °C.
- (2) Flux must affect neither components nor connectors.
- (3) Residue of the flux must be easy to remove.

Good flux or solder paste with these properties is available on the market. A recommended flux is Alpha 5003 diluted with benzyl alcohol. Dilution used will vary with application and must be determined empirically.

Having first been fluxed, all components are positioned on the substrate. The slight adhesive force of the flux is sufficient to keep the components in place.

Because solder paste contains a flux, it has good inherent adhesive properties which eases positioning of the components. Allow flux to dry at room temperature or in a 70 °C oven. Flux should be dry to the touch. Time required will depend on flux used.

With the components in position, the substrate is heated to a point where the solder begins to flow. This can be done on a heating plate, on a conveyor belt running through an infrared tunnel, or by using vapor phase soldering.

In the vapor phase soldering process, the entire PC board is uniformly heated within a vapor phase zone at a temperature of approximately 215 °C. The saturated vapor phase zone is obtained by heating an inert (inactive) fluid to the boiling point. The vapor phase is locked in place by a secondary vapor. (Figure AN1005.1) Vapor phase soldering provides uniform heating and prevents overheating.

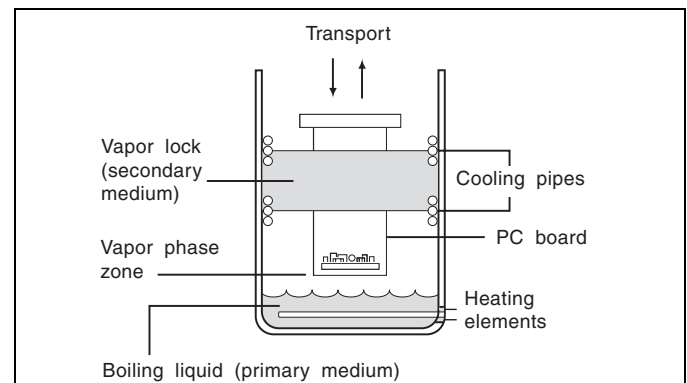

Figure AN1005.1 Principle of Vapor Phase Soldering

No matter which method of heating is used, the maximum allowed temperature of the plastic body must not exceed 250 °C during the soldering process. For additional information on temperature behavior during the soldering process, see Figure AN1005.2 and Figure AN1005.3.

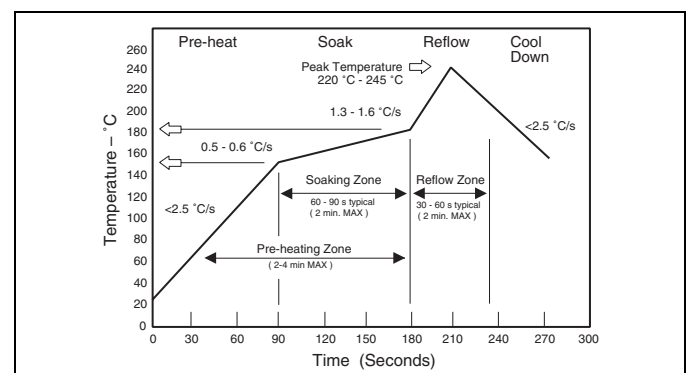

Figure AN1005.2 Reflow Soldering Profile

Reflow Soldering Zones

Zone 1: Initial Pre-heating Stage (25 °C to 150 °C)

- Excess solvent is driven off.
- PCB and Components are gradually heated up.
- Temperature gradient shall be <math><2.5\text{ }^{\circ}\text{C}/\text{Sec}</math>.

Zone 2: Soak Stage (150 °C to 180 °C)

- Flux components start activation and begin to reduce the oxides on component leads and PCB pads.
- PCB components are brought nearer to the temperature at which solder bonding can occur.
- Soak allows different mass components to reach the same temperature.
- Activated flux keeps metal surfaces from re-oxidizing.

Zone 3: Reflow Stage (180 °C to 235 °C)

- Paste is brought to the alloy's melting point.
- Activated flux reduces surface tension at the metal interface so metallurgical bonding occurs.

Zone 4: Cool-down Stage (180 °C to 25 °C)

Assembly is cooled evenly so thermal shock to the components or PCB is reduced.

The surface tension of the liquid solder tends to draw the leads of the device towards the center of the soldering area and so has a correcting effect on slight mispositionings. However, if the layout is not optimized, the same effect can result in undesirable shifts, particularly if the soldering areas on the substrate and the components are not concentrically arranged. This problem can be solved by using a standard contact pattern which leaves sufficient scope for the self-positioning effect (Figure AN1005.3 and Figure AN1005.4) Figure AN1005.5 shows the reflow soldering procedure.

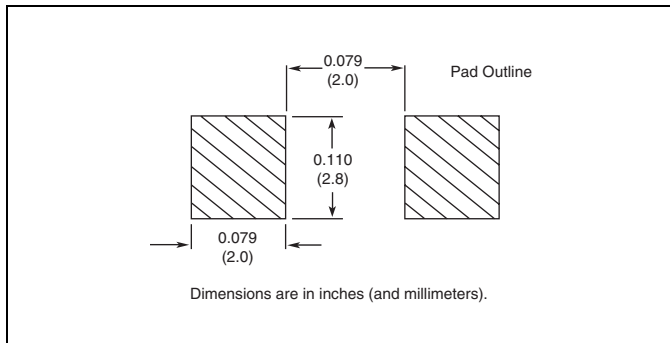

Figure AN1005.3 Minimum Required Dimensions of Metal Connection of Typical DO-214 Pads on Hybrid Thick- and Thin-film Substrates

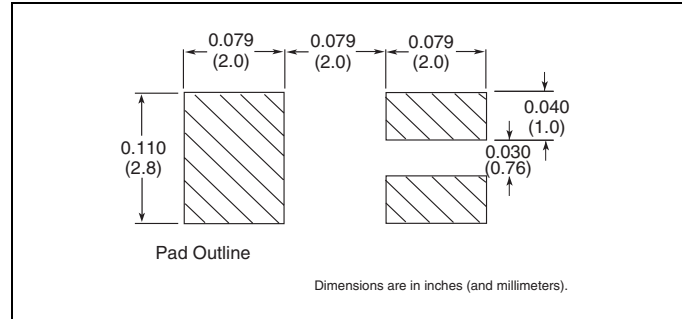

Figure AN1005.4 Modified DO-214 Compak — Three-leaded Surface Mount Package

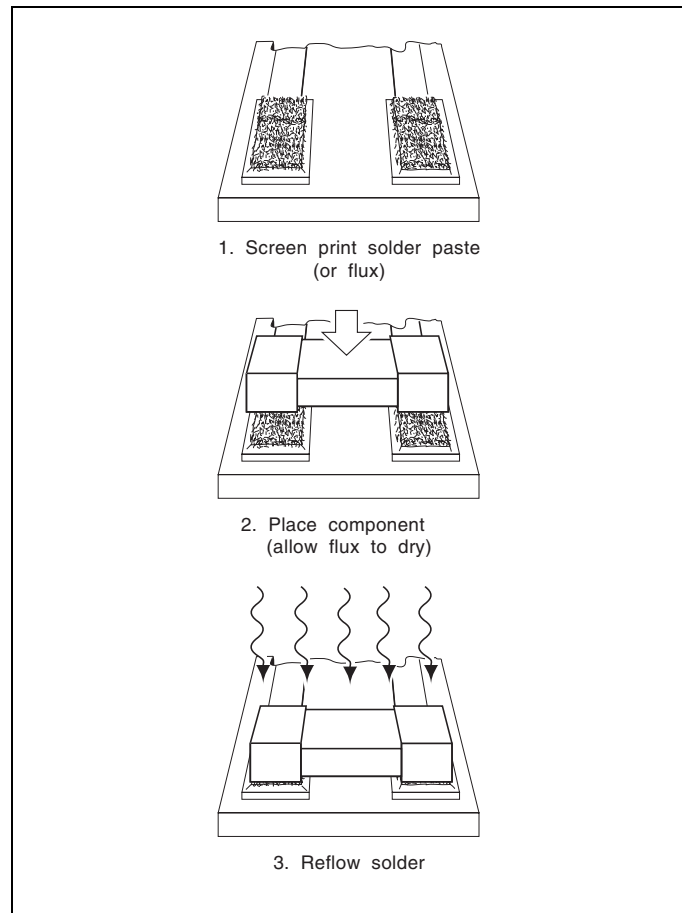

Figure AN1005.5 Reflow Soldering Procedure

After the solder is set and cooled, visually inspect the connections and, where necessary, correct with a soldering iron. Finally, the remnants of the flux must be removed carefully.

Use vapor degrease with an azeotrope solvent or equivalent to remove flux. Allow to dry.

After the drying procedure is complete, the assembly is ready for testing and/or further processing.

Wave Soldering

Wave soldering is the most commonly used method for soldering components in PCB assemblies. As with other soldering processes, a flux is applied before soldering. After the flux is applied, the surface mount devices are glued into place on a PC board. The board is then placed in contact with a molten wave of solder at a temperature between 240 °C and 260 °C, which affixes the component to the board.

Dual wave solder baths are also in use. This procedure is the same as mentioned above except a second wave of solder removes excess solder.

Although wave soldering is the most popular method of PCB assembly, drawbacks exist. The negative features include solder bridging and shadows (pads and leads not completely wetted) as board density increases. Also, this method has the sharpest thermal gradient. To prevent thermal shock, some sort of pre-heating device must be used. Figure AN1005.6 shows the procedure for wave soldering PCBs with surface mount devices only. Figure AN1005.7 shows the procedure for wave soldering PCBs with both surface mount and leaded components.

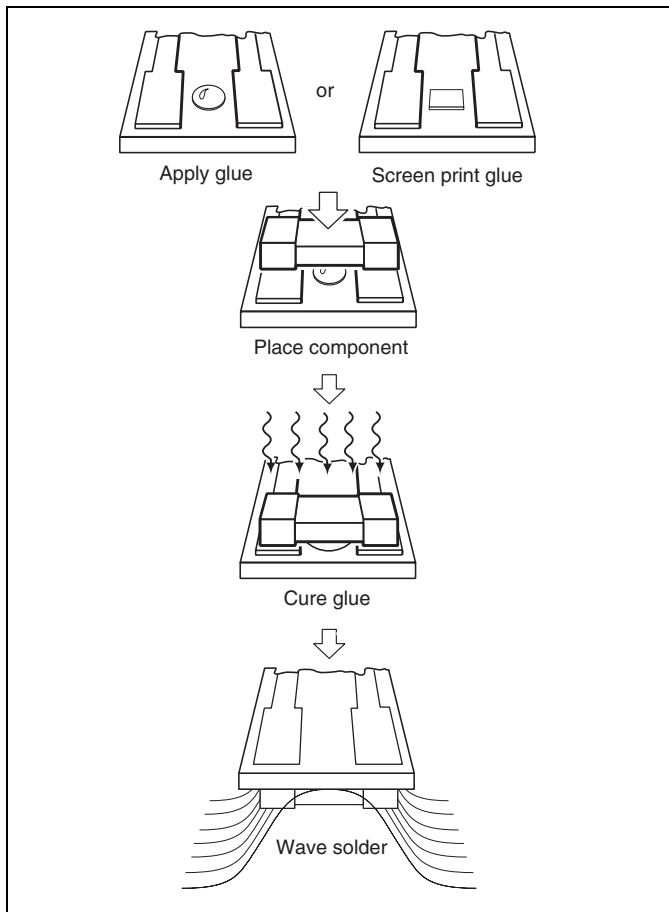

Figure AN1005.6 Wave Soldering PCBs With Surface Mount Devices Only

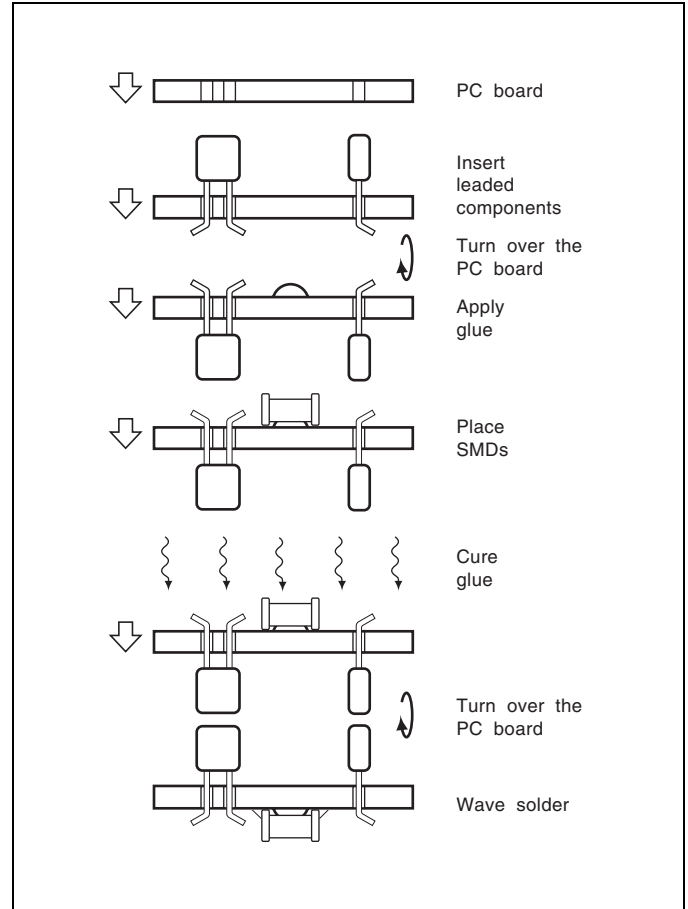

Figure AN1005.7 Wave Soldering PCBs With Both Surface Mount and Leaded Components

Immersion Soldering

Maximum allowed temperature of the soldering bath is 235 °C. Maximum duration of soldering cycle is five seconds, and forced cooling must be applied.

Hand Soldering

It is possible to solder the DO-214, Compak, and TO-252 devices with a miniature hand-held soldering iron, but this method has particular drawbacks and should be restricted to laboratory use and/or incidental repairs on production circuits.

Recommended Metal-alloy

- (1) 63/37 Sn/Pb
- (2) 60/40 Sn/Pb

Pre-Heating

Pre-heating is recommended for good soldering and to avoid damage to the DO-214, Compak, TO-252 devices, other components, and the substrate. Maximum pre-heating temperature is 165 °C while the maximum pre-heating duration may be 10 seconds. However, atmospheric pre-heating is permissible for several minutes provided temperature does not exceed 125 °C.

Gluing Recommendations

Prior to wave soldering, surface mount devices (SMDs) must be fixed to the PCB or substrate by means of an appropriate adhesive. The adhesive (in most cases a multicomponent adhesive) has to fulfill the following demands:

- Uniform viscosity to ensure easy coating
- No chemical reactions upon hardening in order not to deteriorate component and PC board
- Straightforward exchange of components in case of repair

Low-temperature Solder for Reducing PC Board Damage

In testing and troubleshooting surface-mounted components, changing parts can be time consuming. Moreover, desoldering and soldering cycles can loosen and damage circuit-board pads. Use low-temperature solder to minimize damage to the PC board and to quickly remove a component. One low-temperature alloy is indium-tin, in a 50/50 mixture. It melts between 118 °C and 125 °C, and tin-lead melts at 183 °C. If a component needs replacement, holding the board upside down and heating the area with a heat gun will cause the component to fall off. Performing the operation quickly minimizes damage to the board and component.

Proper surface preparation is necessary for the In-Sn alloy to wet the surface of the copper. The copper must be clean, and you must add flux to allow the alloy to flow freely. You can use rosin dissolved in alcohol. Perform the following steps:

- (1) Cut a small piece of solder and flow it onto one of the pads.
- (2) Place the surface-mount component on the pad and melt the soldered pad to its pin while aligning the part. (This operation places all the pins flat onto their pads.)

- (3) Cut small pieces of the alloy solder and flow each piece onto each of the other legs of the component.

Indium-tin solder is available from ACI Alloys, San Jose, CA and Indium Corporation of America, Utica, NY.

Multi-use Footprint

Package soldering footprints can be designed to accommodate more than one package. Figure AN1005.8 shows a footprint design for using both the Compak and an SOT-223. Using the dual pad outline makes it possible to use more than one supplier source.

Cleaning Recommendations

Using solvents for PC board or substrate cleaning is permitted from approximately 70 °C to 80 °C.

The soldered parts should be cleaned with azeotrope solvent followed by a solvent such as methol, ethyl, or isopropyl alcohol.

Ultrasonic cleaning of surface mount components on PCBs or substrates is possible.

The following guidelines are recommended when using ultrasonic cleaning:

- Cleaning agent: Isopropanol
- Bath temperature: approximately 30 °C
- Duration of cleaning: MAX 30 seconds
- Ultrasonic frequency: 40 kHz
- Ultrasonic changing pressure: approximately 0.5 bar

Cleaning of the parts is best accomplished using an ultrasonic cleaner which has approximately 20 W of output per one liter of solvent. Replace the solvent on a regular basis.

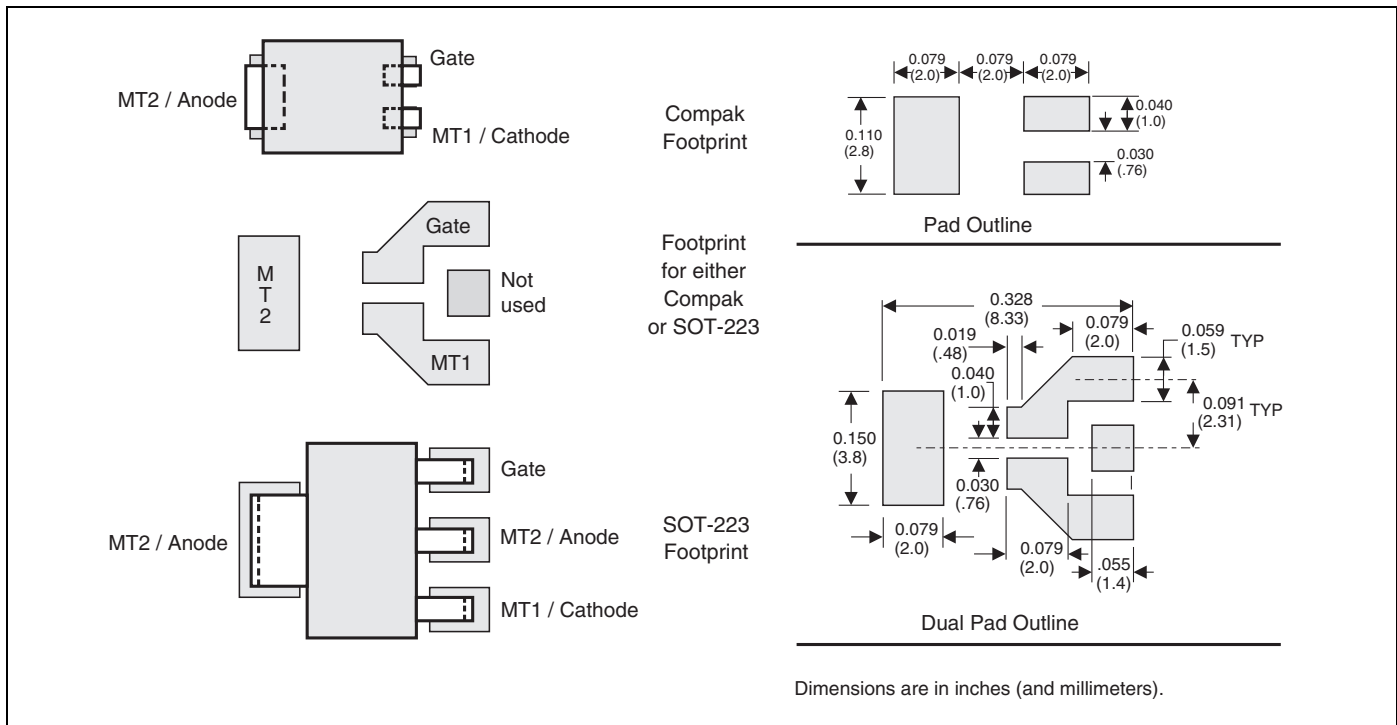

Figure AN1005.8 Dual Footprint for *Compak* Package

Testing Teccor Semiconductor Devices Using Curve Tracers

Introduction

One of the most useful and versatile instruments for testing semiconductor devices is the curve tracer (CT). Tektronix is the best known manufacturer of curve tracers and produces four basic models: 575, 576, 577 and 370. These instruments are specially adapted CRT display screens with associated electronics such as power supplies, amplifiers, and variable input and output functions that allow the user to display the operating characteristics of a device in an easy-to-read, standard graph form. Operation of Tektronix CTs is simple and straightforward and easily taught to non-technical personnel. Although widely used by semiconductor manufacturers for design and analytical work, the device consumer will find many uses for the curve tracer, such as incoming quality control, failure analysis, and supplier comparison. Curve tracers may be easily adapted for go-no go production testing. Tektronix also supplies optional accessories for specific applications along with other useful hardware.

Tektronix Equipment

Although Tektronix no longer produces curve tracer model 575, many of the units are still operating in the field, and it is still an extremely useful instrument. The 576, 577 and 370 are current curve tracer models and are more streamlined in their appearance and operation. The 577 is a less elaborate version of the 576, yet retains all necessary test functions.

The following basic functions are common to all curve tracers:

- **Power supply** supplies positive DC voltage, negative DC voltage, or AC voltage to bias the device. Available power is varied by limiting resistors.
- **Step generator** supplies current or voltage in precise steps to control the electrode of the device. The number, polarity, and frequency of steps are selectable.
- **Horizontal amplifier** displays power supply voltage as applied to the device. Scale calibration is selectable.
- **Vertical amplifier** displays current drawn from the supply by the device. Scale calibration is selectable.

Curve tracer controls for beam position, calibration, pulse operation, and other functions vary from model to model. The basic theory of operation is that for each curve one terminal is driven with a constant voltage or current and the other one is swept with a half sinewave of voltage. The driving voltage is stepped

through several values, and a different trace is drawn on each sweep to generate a family of curves.

Limitations, Accuracy, and Correlation

Although the curve tracer is a highly versatile device, it is not capable of every test that one may wish to perform on semiconductor devices such as dv/dt , secondary reverse breakdown, switching speeds, and others. Also, tests at very high currents and/or voltages are difficult to conduct accurately and without damaging the devices. A special high-current test fixture available from Tektronix can extend operation to 200 A pulsed peak. Kelvin contacts available on the 576 and 577 eliminate inaccuracy in voltage measured at high current (V_{TM}) by sensing voltage drop due to contact resistance and subtracting from the reading.

Accuracy of the unit is within the published manufacturer's specification. Allow the curve tracer to warm up and stabilize before testing begins. Always expand the horizontal or vertical scale as far as possible to increase the resolution. Be judicious in recording data from the screen, as the trace line width and scale resolution factor somewhat limit the accuracy of what may be read. Regular calibration checks of the instrument are recommended. Some users keep a selection of calibrated devices on hand to verify instrument operation when in doubt. Re-calibration or adjustment should be performed only by qualified personnel.

Often discrepancies exist between measurements taken on different types of instrument. In particular, most semiconductor manufacturers use high-speed, computerized test equipment to test devices. They test using very short pulses. If a borderline unit is then measured on a curve tracer, it may appear to be out of specification. The most common culprit here is heat. When a semiconductor device increases in temperature due to current flow, certain characteristics may change, notably gate characteristics on SCRs, gain on transistors, leakage, and so on. It is very difficult to operate the curve tracer in such a way as to eliminate the heating effect. Pulsed or single-trace operation helps reduce this problem, but care should be taken in comparing curve tracer measurements to computer tests. Other factors such as stray capacitances, impedance matching, noise, and device oscillation also may create differences.

Safety (Cautions and Warnings)

Adhere rigidly to Tektronix safety rules supplied with each curve tracer. No attempt should be made to defeat any of the safety interlocks on the device as the curve tracer can produce a lethal shock. Also, older 575 models do not have the safety interlocks as do the new models. Take care never to touch any device or open the terminal while energized.

WARNING: Devices on the curve tracer may be easily damaged from electrical overstress.

Follow these rules to avoid destroying devices:

- Familiarize yourself with the expected maximum limits of the device.
- Limit the current with the variable resistor to the minimum necessary to conduct the test.
- Increase power slowly to the specified limit.
- Watch for device "runaway" due to heating.
- Apply and increase gate or base drive slowly and in small steps.
- Conduct tests in the minimum time required.

General Test Procedures

Read all manuals before operating a curve tracer.

Perform the following manufacturer's equipment check:

1. Turn on and warm up curve tracer, but turn off, or down, all power supplies.
2. Correctly identify terminals of the device to be tested. Refer to the manufacturer's guide if necessary.
3. Insert the device into the test fixture, matching the device and test terminals.
4. Remove hands from the device and/or close interlock cover.
5. Apply required bias and/or drive.
6. Record results as required.
7. Disconnect all power to the device before removing.

Model 576 Curve Tracer Procedures

The following test procedures are written for use with the model 576 curve tracer. (Figure AN1006.1)

See "Model 370 Curve Tracer Procedure Notes" on page AN1006-16 and "Model 577 Curve Tracer Procedure Notes" on page AN1006-18 for setting adjustments required when using model 370 and 577 curve tracers.

The standard 575 model lacks AC mode, voltage greater than 200 V, pulse operations, DC mode, and step offset controls. The 575 MOD122C does allow voltage up to 400 V, including 1500 V in an AC mode. Remember that at the time of design, the 575 was built to test only transistors and diodes. Some ingenuity, experience, and external hardware may be required to test other types of devices.

For further information or assistance in device testing on Tektronix curve tracers, contact the Teccor Applications Engineering group.

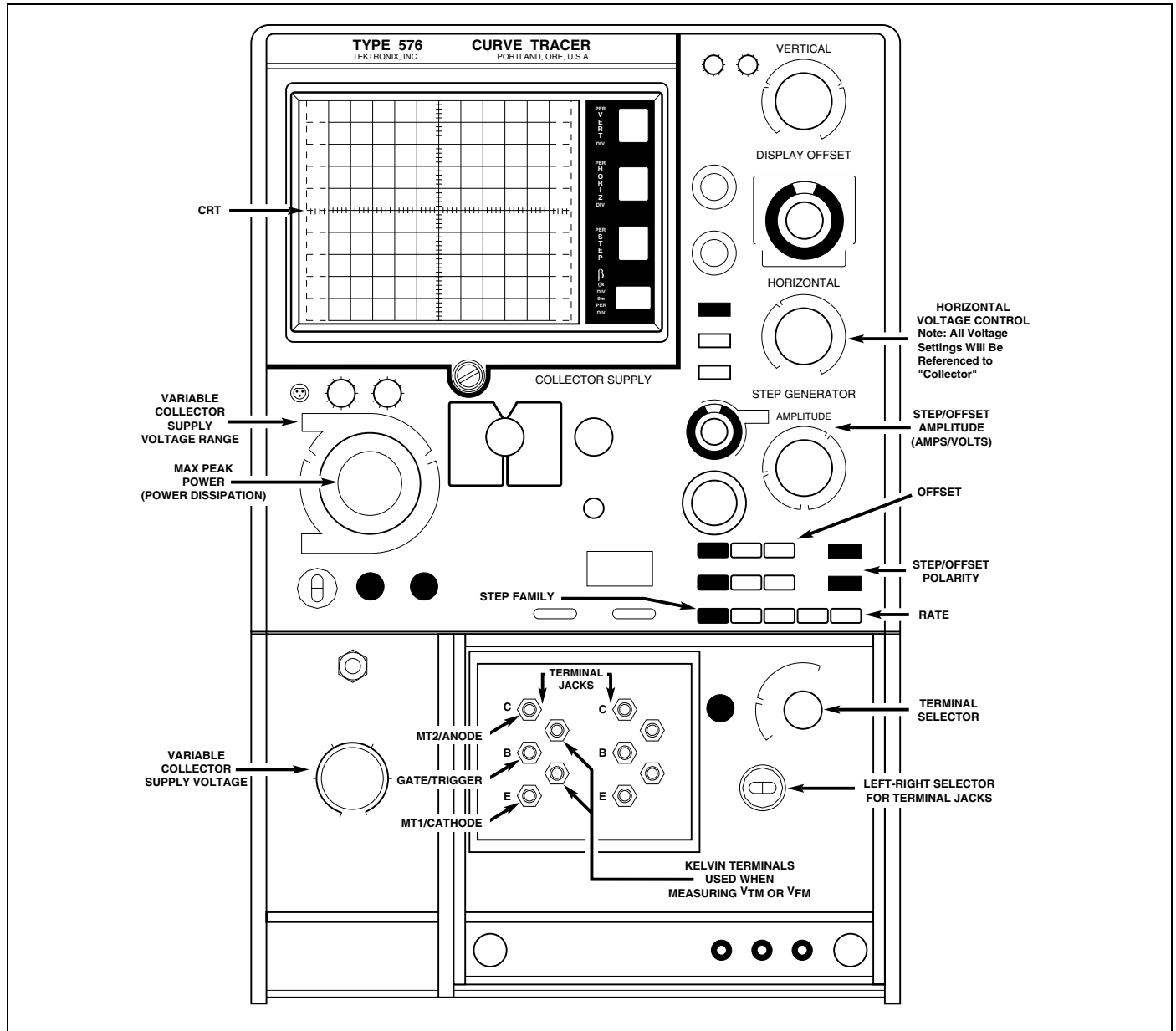

Figure AN1006.1 Tektronix Model 576 Curve Tracer

Power Rectifiers

The rectifier is a unidirectional device which conducts when forward voltage (above 0.7 V) is applied.

To connect the rectifier:

1. Connect *Anode* to *Collector Terminal (C)*.
2. Connect *Cathode* to *Emitter Terminal (E)*.

To begin testing, perform the following procedures.

Procedure 1: V_{RRM} and I_{RM}

To measure the V_{RRM} and I_{RM} parameter:

1. Set **Variable Collector Supply Voltage Range** to 1500 V. (2000 V on 370)
2. Set **Horizontal** knob to sufficient scale to allow viewing of trace at the required voltage level (100 V/DIV for 400 V and 600 V devices and 50 V/DIV for 200 V devices).
3. Set **Mode** to *Leakage*.
4. Set **Vertical** knob to 100 $\mu\text{A}/\text{DIV}$. (Due to leakage setting, the CRT readout will be 100 nA per division.)
5. Set **Terminal Selector** to *Emitter Grounded-Open Base*.
6. Set **Polarity** to (-).
7. Set **Power Dissipation** to 2.2 W. (2 W on 370)
8. Set **Left-Right Terminal Jack Selector** to correspond with location of test fixture.
9. Increase **Variable Collector Supply Voltage** to the rated V_{RRM} of the device and observe the dot on the CRT. Read across horizontally from the dot to the vertical current scale. This measured value is the leakage current. (Figure AN1006.2)

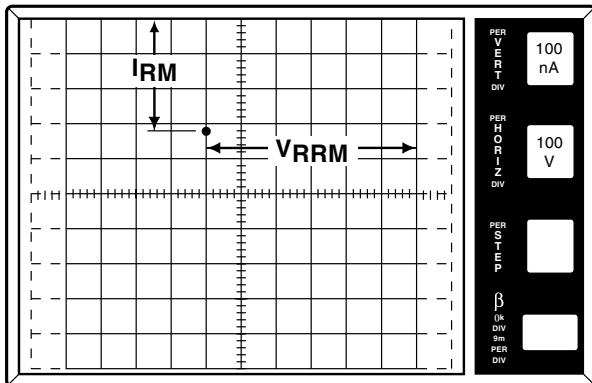

Figure AN1006.2 $I_{RM} = 340 \text{ nA}$ at $V_{RRM} = 600 \text{ V}$

Procedure 2: V_{FM}

Before testing, note the following:

- A Kelvin test fixture is required for this test. If a Kelvin fixture is not used, an error in measurement of V_{FM} will result due to voltage drop in fixture. If a Kelvin fixture is not available, Figure AN1006.3 shows necessary information to wire a test fixture with Kelvin connections.
- Due to the current limitations of standard curve tracer model 576, V_{FM} cannot be tested at rated current without a Tek-

tronix model 176 high-current module. The procedure below is done at $I_{T(RMS)} = 10 \text{ A}$ (20 A_{PK}). This test parameter allows the use of a standard curve tracer and still provides an estimate of whether V_{FM} is within specification.

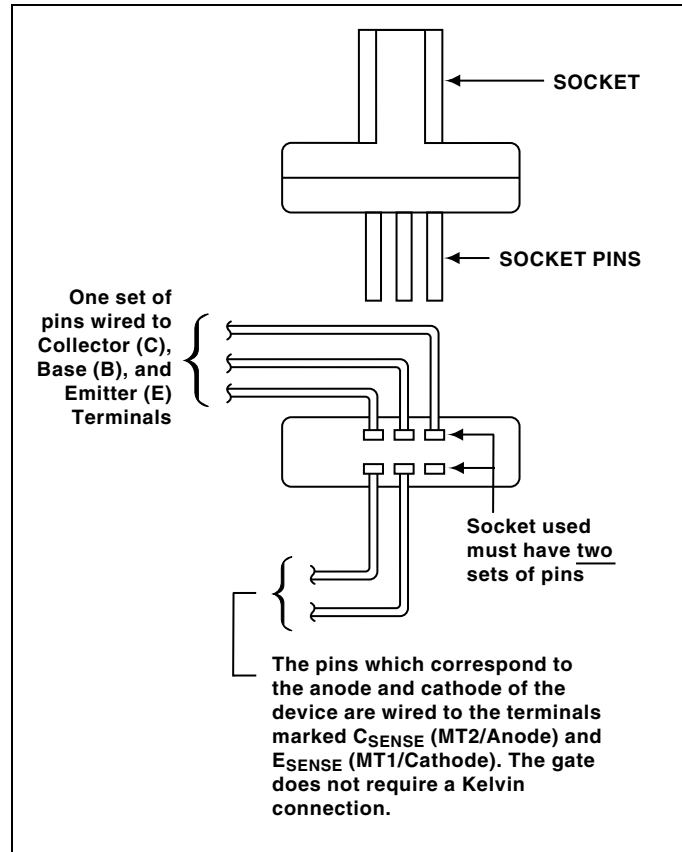

Figure AN1006.3 Instructions for Wiring Kelvin Socket

To measure the V_{FM} parameter:

1. Set **Variable Collector Supply Voltage Range** to 15 Max Peak Volts. (16 V on 370)
2. Set **Horizontal** knob to 0.5 V/DIV.
3. Set **Mode** to *Norm*.
4. Set **Vertical** knob to 2 A/DIV.
5. Set **Power Dissipation** to 220 W (100 W on 577).
6. Set **Polarity** to (+).
7. Set **Left-Right Terminal Jack Selector** to correspond with location of test fixture.
8. Increase **Variable Collector Supply Voltage** until current reaches 20 A.

WARNING: Limit test time to 15 seconds maximum.

To measure V_{FM} , follow along horizontal scale to the point where the trace crosses the 20 A axis. The distance from the left-hand side of scale to the crossing point is the V_{FM} value. (Figure AN1006.4)

Note: Model 370 current is limited to 10 A.

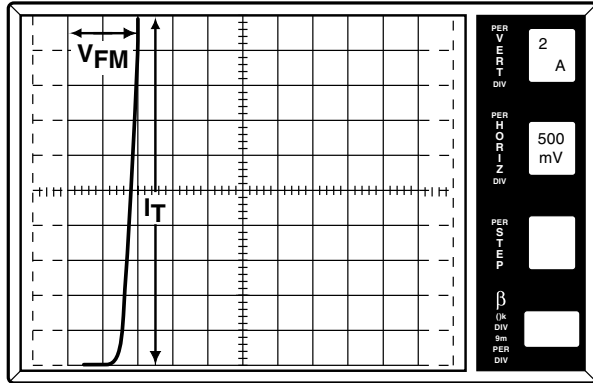
Figure AN1006.4 $V_{FM} = 1 \text{ V}$ at $I_{PK} = 20 \text{ A}$

SCRs

SCRs are half-wave unidirectional rectifiers turned on when current is supplied to the gate terminal. If the current supplied to the gate is to be in the range of $12 \mu\text{A}$ and $500 \mu\text{A}$, then a sensitive SCR is required; if the gate current is between 1 mA and 50 mA , then a non-sensitive SCR is required.

To connect the rectifier:

1. Connect *Anode* to *Collector Terminal (C)*.
2. Connect *Cathode* to *Emitter Terminal (E)*.

Note: When sensitive SCRs are being tested, a $1 \text{ k}\Omega$ resistor must be connected between the gate and the cathode, except when testing I_{GT} .

To begin testing, perform the following procedures.

Procedure 1: V_{DRM} , V_{RRM} , I_{DRM} , I_{RRM}

To measure the V_{DRM} , V_{RRM} , I_{DRM} , and I_{RRM} parameter:

1. Set **Variable Collector Supply Voltage Range** to appropriate *Max Peak Volts* for device under test. (Value selected should be equal to or greater than the device's V_{DRM} rating.)
2. Set **Horizontal** knob to sufficient scale to allow viewing of trace at the required voltage level. (The 100 V/DIV scale should be used for testing devices having a V_{DRM} value of 600 V or greater; the 50 V/DIV scale for testing parts rated from 300 V to 500 V , and so on.)
3. Set **Mode** to *Leakage*.
4. Set **Polarity** to (+).
5. Set **Power Dissipation** to 0.5 W . (0.4 W on 370)
6. Set **Terminal Selector** to *Emitter Grounded-Open Base*.
7. Set **Vertical** knob to approximately ten times the maximum leakage current (I_{DRM} , I_{RRM}) specified for the device. (For sensitive SCRs, set to $50 \mu\text{A}$.)

Note: The CRT screen readout should show 1% of the maximum leakage current if the vertical scale is divided by 1,000 when leakage current mode is used.

Procedure 2: V_{DRM} , I_{DRM}

To measure the V_{DRM} and I_{DRM} parameter:

1. Set **Left-Right Terminal Jack Selector** to correspond with location of test fixture.
2. Set **Variable Collector Supply Voltage** to the rated V_{DRM} of the device and observe the dot on CRT. Read across horizontally from the dot to the vertical current scale. This measured value is the leakage current. (Figure AN1006.5)

WARNING: Do NOT exceed V_{DRM}/V_{RRM} rating of SCRs, triacs, or *Quadracs*. These devices can be damaged.

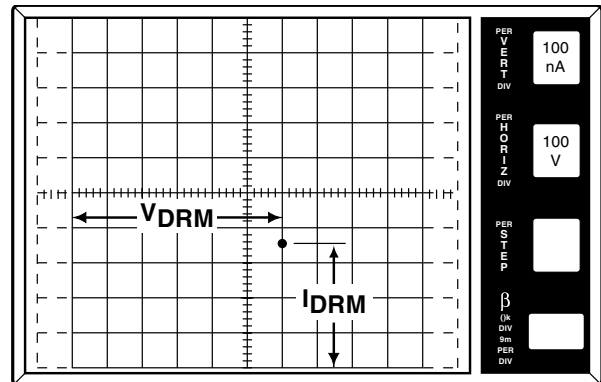
Figure AN1006.5 $I_{DRM} = 350 \text{ nA}$ at $V_{DRM} = 600 \text{ V}$

Procedure 3: V_{RRM} , I_{RRM}

To measure the V_{RRM} and I_{RRM} parameter:

1. Set **Polarity** to (-).
2. Repeat Steps 1 and 2 (V_{DRM} , I_{DRM}) except substitute V_{RRM} value for V_{DRM} . (Figure AN1006.6)

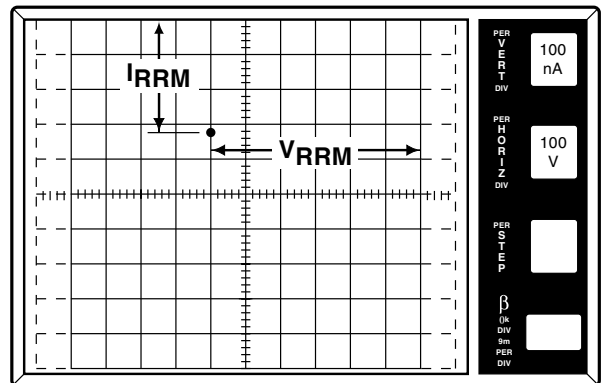
Figure AN1006.6 $I_{RRM} = 340 \text{ nA}$ at $V_{RRM} = 600 \text{ V}$

Procedure 4: V_{TM}

To measure the V_{TM} parameter:

1. Set **Terminal Selector** to *Step Generator-Emitter Grounded*.
2. Set **Polarity** to (+).
3. Set **Step/Offset Amplitude** to twice the maximum I_{GT} rating of the device (to ensure the device turns on). For sensitive SCRs, set to 2 mA .
4. Set **Max Peak Volts** to 15 V . (16 V on 370)
5. Set **Offset** by depressing 0 (zero).

- Set **Rate** by depressing *Norm*.
- Set **Step Family** by depressing *Rep* (repetitive).
- Set **Mode** to *DC*.
- Set **Horizontal** knob to *0.5 V/DIV*.
- Set **Power Dissipation** to *220 W* (*100 W* on 577).
- Set **Number of Steps** to *1*. (Set steps to *0* (zero) on 370.)
- Set **Vertical** knob to a sufficient setting to allow the viewing of 2 times the $I_{T(RMS)}$ rating of the device ($I_{T(peak)}$) on CRT.

Before continuing with testing, note the following:

- Due to the excessive amount of power that can be generated in this test, only parts with an $I_{T(RMS)}$ rating of 6 A or less should be tested on standard curve tracer. If testing devices above 6 A, a Tektronix model 176 high-current module is required.
 - A Kelvin test fixture is required for this test. If a Kelvin fixture is not used, an error in measurement of V_{TM} will result due to voltage drop in the fixture. If a Kelvin fixture is not available, Figure AN1006.3 shows necessary information to wire a test fixture with Kelvin connectors.
- Set **Left-Right Terminal Jack Selector** to correspond with the location of the test fixture.
 - Increase **Variable Collector Supply Voltage** until current reaches rated $I_{T(peak)}$, which is twice the $I_{T(RMS)}$ rating of the SCR under test.

Note: Model 370 current is limited to 10 A.

WARNING: Limit test time to 15 seconds maximum after the Variable Collector Supply has been set to $I_{T(peak)}$, After the Variable Collector Supply Voltage has been set to $I_{T(peak)}$, the test time can automatically be shortened by changing Step Family from repetitive to single by depressing the Single button.

To measure V_{TM} , follow along horizontal scale to the point where the trace crosses the $I_{T(peak)}$ value. The distance from the left-hand side of scale to the intersection point is the V_{TM} value. (Figure AN1006.7)

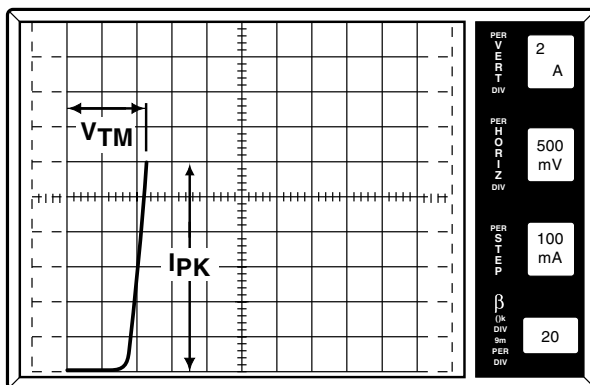

Figure AN1006.7 $V_{TM} = 1.15 \text{ V}$ at $I_{T(peak)} = 12 \text{ A}$

Procedure 5: I_H

To measure the I_H parameter:

- Set **Polarity** to (+).
- Set **Power Dissipation** to *2.2 W*. (*2 W* on 370)

- Set **Max Peak Volts** to *75 V*. (*80 V* on 370)
 - Set **Mode** to *DC*.
 - Set **Horizontal** knob to *Step Generator*.
 - Set **Vertical** knob to approximately 10 percent of the maximum I_H specified.
- Note: Due to large variation of holding current values, the scale may have to be adjusted to observe holding current.
- Set **Number of Steps** to *1*.
 - Set **Offset** by depressing *0* (zero). (Press *Aid* and *Oppose* at the same time on 370.)
 - Set **Step/Offset Amplitude** to twice the maximum I_{GT} of the device.
 - Set **Terminal Selector** to *Step Generator-Emitter Grounded*.
 - Set **Step Family** by depressing *Single*.
 - Set **Left-Right Terminal Jack Selector** to correspond with location of test fixture.
 - Increase **Variable Collector Supply Voltage** to maximum position (*100*).
 - Set **Step Family** by depressing *Single*. (This could possibly cause the dot on CRT to disappear, depending on the vertical scale selected.)
 - Change **Terminal Selector** from *Step Generator-Emitter Grounded* to *Open Base-Emitter Grounded*.
 - Decrease **Variable Collector Supply Voltage** to the point where the line on the CRT changes to a dot. The position of the beginning point of the line, just before the line becomes a dot, represents the holding current value. (Figure AN1006.8)

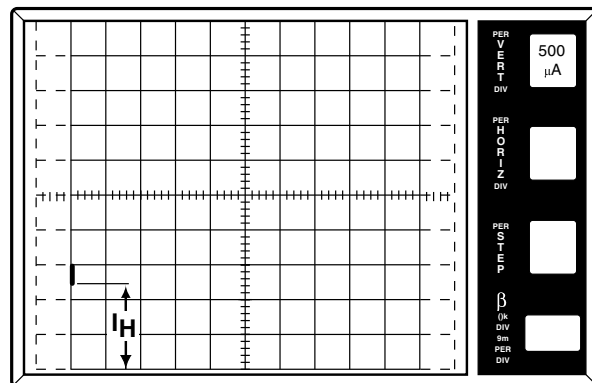

Figure AN1006.8 $I_H = 1.2 \text{ mA}$

Procedure 6: I_{GT} and V_{GT}

To measure the I_{GT} and V_{GT} parameter:

- Set **Polarity** to (+).
- Set **Number of Steps** to *1*.
- Set **Offset** by depressing *Aid*.
- Set **Offset Multiplier** to *0* (zero). (Press *Aid* and *Oppose* at the same time on 370.)
- Set **Terminal Selector** to *Step Generator-Emitter Grounded*.
- Set **Mode** to *Norm*.
- Set **Max Peak Volts** to *15 V*. (*16 V* on 370)

- Set **Power Dissipation** to 2.2 W. (2 W on 370) For sensitive SCRs, set at 0.5 W. (0.4 W on 370)
- Set **Horizontal** knob to 2 V/DIV.
- Set **Vertical** knob to 50 mA/DIV.
- Increase **Variable Collector Supply Voltage** until voltage reaches 12 V on CRT.
- After 12 V setting is completed, change **Horizontal** knob to *Step Generator*.

Procedure 7: I_{GT}

To measure the I_{GT} parameter:

- Set **Step/Offset Amplitude** to 20% of maximum rated I_{GT} .
Note: R_{GK} should be removed when testing I_{GT} .
- Set **Left-Right Terminal Jack Selector** to correspond with location of the test fixture.
- Gradually increase **Offset Multiplier** until device reaches the conduction point. (Figure AN1006.9) Measure I_{GT} by following horizontal axis to the point where the vertical line crosses axis. This measured value is I_{GT} . (On 370, I_{GT} will be numerically displayed on screen under offset value.)

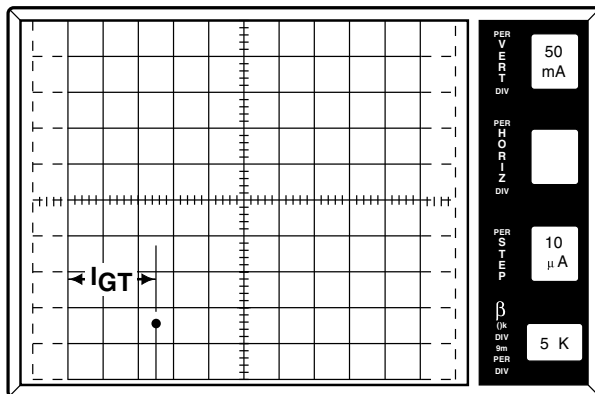

Figure AN1006.9 $I_{GT} = 25 \mu A$

Procedure 8: V_{GT}

To measure the V_{GT} parameter:

- Set **Offset Multiplier** to 0 (zero). (Press *Aid* and *Oppose* at the same time on 370.)
- Set **Step Offset Amplitude** to 20% rated V_{GT} .
- Set **Left-Right Terminal Jack Selector** to correspond with location of test fixture.
- Gradually increase **Offset Multiplier** until device reaches the conduction point. (Figure AN1006.10) Measure V_{GT} by following horizontal axis to the point where the vertical line crosses axis. This measured value is V_{GT} . (On 370, V_{GT} will be numerically displayed on screen, under offset value.)

Procedure 9: V_{GT} will be numerically displayed on screen under offset value.)

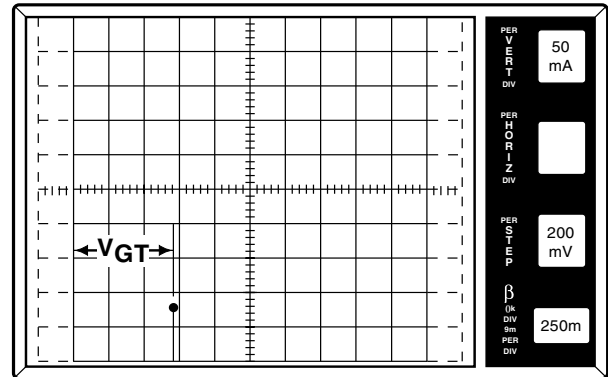

Figure AN1006.10 $V_{GT} = 580 mV$

Triacs

Triacs are full-wave bidirectional AC switches turned on when current is supplied to the gate terminal of the device. If gate control in all four quadrants is required, then a sensitive gate triac is needed, whereas a standard triac can be used if gate control is only required in Quadrants I through III.

To connect the triac:

- Connect the *Gate* to the *Base Terminal* (B).
- Connect *MT1* to the *Emitter Terminal* (E).
- Connect *MT2* to the *Collector Terminal* (C).

To begin testing, perform the following procedures.

Procedure 1: (+) V_{DRM} , (+) I_{DRM} , (-) V_{DRM} , (-) I_{DRM}

Note: The (+) and (-) symbols are used to designate the polarity MT2 with reference to MT1.

To measure the (+) V_{DRM} , (+) I_{DRM} , (-) V_{DRM} , and (-) I_{DRM} parameter:

- Set **Variable Collector Supply Voltage Range** to appropriate *Max Peak Volts* for device under test. (Value selected should be equal to the device's V_{DRM} rating.)

WARNING: Do NOT exceed V_{DRM}/V_{RRM} rating of SCRs, triacs, or Quadracs. These devices can be damaged.

- Set **Horizontal** knob to sufficient scale to allow viewing of trace at the required voltage level. (The 100 V/DIV scale should be used for testing devices having a V_{DRM} rating of 600 V or greater; the 50 V/DIV scale for testing parts rated from 30 V to 500 V, and so on.)
- Set **Mode** to *Leakage*.
- Set **Polarity** to (+).
- Set **Power Dissipation** to 0.5 W. (0.4 W on 370)
- Set **Terminal Selector** to *Emitter Grounded-Open Base*.
- Set **Vertical** knob to ten times the maximum leakage current (I_{DRM}) specified for the device.

Note: The CRT screen readout should show 1% of the maximum leakage current. The vertical scale is divided by 1,000 when leakage mode is used.

Procedure 2: (+) V_{DRM} , (+) I_{DRM}

To measure the (+) V_{DRM} and (+) I_{DRM} parameter:

1. Set **Left-Right Terminal Jack Selector** to correspond with location of the test fixture.
2. Increase **Variable Collector Supply Voltage** to the rated V_{DRM} of the device and observe the dot on the CRT. Read across horizontally from the dot to the vertical current scale. This measured value is the leakage current. (Figure AN1006.11)

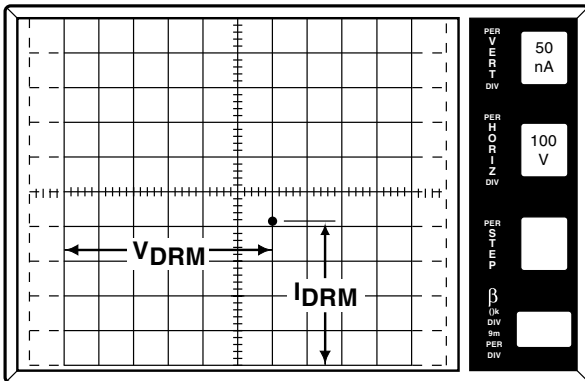

Figure AN1006.11 (+) I_{DRM} = 205 nA at (+) V_{DRM} = 600 V

Procedure 3: (-) V_{DRM} , (-) I_{DRM}

To measure the (-) V_{DRM} and (-) I_{DRM} parameter:

1. Set **Polarity** to (-).
2. Repeat Procedures 1 and 2. (Read measurements from upper right corner of the screen.)

Procedure 4: V_{TM} (Forward and Reverse)

To measure the V_{TM} (Forward and Reverse) parameter:

1. Set **Terminal Selector** to *Step Generator-Emitter Grounded*.
2. Set **Step/Offset Amplitude** to twice the maximum I_{GT} rating of the device (to insure the device turns on).
3. Set **Variable Collector Supply Voltage Range** to *15 V Max Peak volts. (16 V on 370)*
4. Set **Offset** by depressing 0 (zero).
5. Set **Rate** by depressing *Norm*.
6. Set **Step Family** by depressing *Rep* (Repetitive).
7. Set **Mode** to *Norm*.
8. Set **Horizontal knob** to *0.5 V/DIV*.
9. Set **Power Dissipation** to *220 W (100 W on 577)*.
10. Set **Number of Steps** to 1.
11. Set **Step/Offset Polarity** to non-inverted (button extended; on 577 button depressed).
12. Set **Vertical knob** to a sufficient setting to allow the viewing of 1.4 times the $I_{T(RMS)}$ rating of the device [$I_{T(peak)}$ on CRT].

Note the following:

- Due to the excessive amount of power that can be generated in this test, only parts with an $I_{T(RMS)}$ rating of 8 A or less should be tested on standard curve tracer. If testing devices above 8 A, a Tektronix model 176 high-current module is required.

- A Kelvin test fixture is required for this test. If a Kelvin fixture is not used, an error in measurement of V_{TM} will result due to voltage drop in fixture. If a Kelvin fixture is not available, Figure AN1006.3 shows necessary information to wire a test fixture with Kelvin connections.

Procedure 5: V_{TM} (Forward)

To measure the V_{TM} (Forward) parameter:

1. Set **Polarity** to (+).
2. Set **Left-Right Terminal Jack Selector** to correspond with location of test fixture.
3. Increase **Variable Collector Supply Voltage** until current reaches rated $I_{T(peak)}$, which is 1.4 times $I_{T(RMS)}$ rating of the triac under test.

Note: Model 370 current is limited to 10 A.

WARNING: Limit test time to 15 seconds maximum. After the Variable Collector Supply Voltage has been set to $I_{T(peak)}$, the test time can automatically be set to a short test time by changing Step Family from repetitive to single by depressing the Single button.

To measure V_{TM} , follow along horizontal scale to the point where the trace crosses the $I_{T(peak)}$ value. The distance from the left-hand side of scale to the crossing point is the V_{TM} value. (Figure AN1006.12)

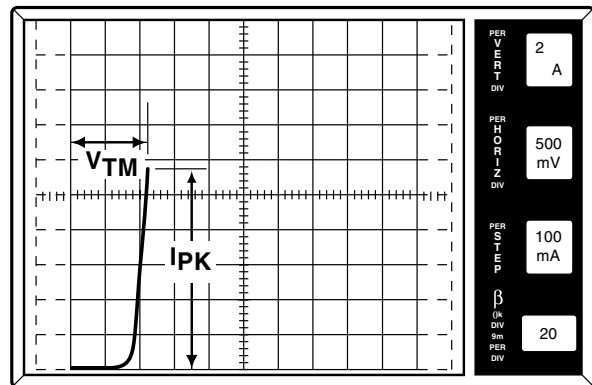

Figure AN1006.12 V_{TM} (forward) = 1.1 V at I_{PK} = 11.3 A (8 A rms)

Procedure 6: V_{TM} (Reverse)

To measure the V_{TM} (Reverse) parameter:

1. Set **Polarity** to (-).
2. Set **Left-Right Terminal Jack Selector** to correspond with the location of the test fixture.
3. Increase **Variable Collector Supply Voltage** until current reaches rated $I_{T(peak)}$.
4. Measure $V_{TM(Reverse)}$ similar to Figure AN1006.12, except from upper right hand corner of screen.

Procedure 7: I_H (Forward and Reverse)

To measure the I_H (Forward and Reverse) parameter:

1. Set **Step/Offset Amplitude** to twice the I_{GT} rating of the device.
2. Set **Power Dissipation** to *10 W*.

- Set **Max Peak Volts** to 75 V. (80 V on 370)
- Set **Mode** to DC.
- Set **Horizontal** knob to *Step Generator*.
- Set **Vertical** knob to approximately 10% of the maximum I_H specified.
Note: Due to large variation of holding current values, the scale may have to be adjusted to observe holding current.
- Set **Number of Steps** to 1.
- Set **Step/Offset Polarity** to non-inverted (button extended, on 577 button depressed).
- Set **Offset** by depressing 0 (zero). (Press *Aid* and *Oppose* at same time on 370.)
- Set **Terminal Selector** to *Step Generator-Emitter Grounded*.

Procedure 8: $I_{H(\text{Forward})}$

To measure the $I_{H(\text{Forward})}$ parameter:

- Set **Polarity** to (+).
- Set **Left-Right Terminal Jack Selector** to correspond with location of test fixture.
- Increase **Variable Collector Supply Voltage** to maximum position (100).
- Set **Step Family** by depressing *Single*.
This could possibly cause the dot on the CRT to disappear, depending on the vertical scale selected).
- Decrease **Variable Collector Supply Voltage** to the point where the line on the CRT changes to a dot. The position of the beginning point of the line, just before the line becomes a dot, represents the holding current value. (Figure AN1006.13)

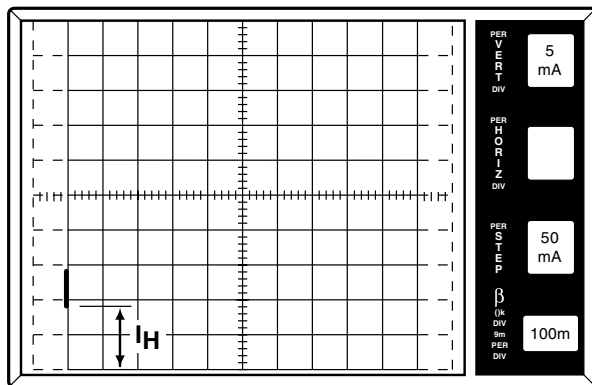

Figure AN1006.13 $I_{H(\text{Forward})} = 8.2 \text{ mA}$

Procedure 9: $I_{H(\text{Reverse})}$

To measure the $I_{H(\text{Reverse})}$ parameter:

- Set **Polarity** to (-).
- Repeat Procedure 7 measuring $I_{H(\text{Reverse})}$. (Read measurements from upper right corner of the screen.)

Procedure 10: I_{GT}

To measure the I_{GT} parameter:

- Set **Polarity** to (+).
- Set **Number of Steps** to 1. (Set number of steps to 0 (zero) on 370.)
- Set **Offset** by depressing *Aid*. (On 577, also set **Zero** button to *Offset*. Button is extended.)
- Set **Offset Multiplier** to 0 (zero). (Press *Aid* and *Oppose* at same time on 370.)
- Set **Terminal Selector** to *Step Generator-Emitter Grounded*.
- Set **Mode** to *Norm*.
- Set **Max Peak Volts** to 15 V. (16 V on 370)
- Set **Power Dissipation** to 10 W.
- Set **Step Family** by depressing *Single*.
- Set **Horizontal** knob to 2 V/DIV.
- Set **Vertical** knob to 50 mA/DIV.
- Set **Step/Offset Polarity** to non-inverted position (button extended, on 577 button depressed).
- Set **Variable Collector Supply Voltage** until voltage reaches 12 V on CRT.
- After 12 V setting is completed, change **Horizontal** knob to *Step Generator*.

Procedure 11: $I_{GT} - \text{Quadrant I [MT2 (+) Gate (+)]}$

To measure the $I_{GT} - \text{Quadrant I}$ parameter:

- Set **Step/Offset Amplitude** to approximately 10% of rated I_{GT} .
- Set **Left-Right Terminal Jack Selector** to correspond with location of test fixture.
- Gradually increase **Offset Multiplier** until device reaches conduction point. (Figure AN1006.14) Measure I_{GT} by following horizontal axis to the point where the vertical line passes through the axis. This measured value is I_{GT} . (On 370, I_{GT} is numerically displayed on screen under offset value.)

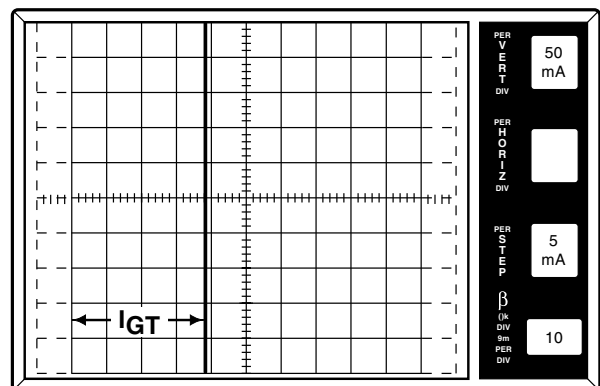

Figure AN1006.14 $I_{GT} \text{ in Quadrant I} = 18.8 \text{ mA}$

Procedure 12: I_{GT} – Quadrant II [MT2 (+) Gate (-)]

To measure the I_{GT} – Quadrant II parameter:

1. Set **Step/Offset Polarity** by depressing *Invert* (release button on 577).
2. Set **Polarity** to (+).
3. Set observed dot to bottom right corner of CRT grid by turning the horizontal position knob. When Quadrant II testing is complete, return dot to original position.
4. Repeat Procedure 11.

Procedure 13: I_{GT} – Quadrant III [MT2 (-) Gate (-)]

To measure the I_{GT} – Quadrant III parameter:

1. Set **Polarity** to (-).
2. Set **Step/Offset Polarity** to non-inverted position (button extended, on 577 button depressed).
3. Repeat Procedure 11. (Figure AN1006.15)

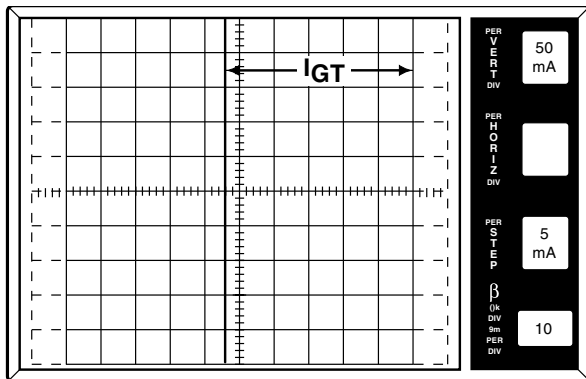

Figure AN1006.15 I_{GT} in Quadrant III = 27 mA

Procedure 14: I_{GT} – Quadrant IV [MT2 (-) Gate (+)]

To measure the I_{GT} – Quadrant IV parameter:

1. Set **Polarity** to (-).
2. Set **Step/Offset Polarity** by depressing *Invert* (release button on 577).
3. Set observed dot to top left corner of CRT grid by turning the **Horizontal** position knob. When Quadrant IV testing is complete, return dot to original position.
4. Repeat Procedure 11.

Procedure 15: V_{GT}

To measure the V_{GT} parameter:

1. Set **Polarity** to (+).
2. Set **Number of Steps** to 1. (Set steps to 0 (zero) on 370.)
3. Set **Offset** by depressing *Aid*. (On 577, also set 0 (zero) button to *Offset*. Button is extended.)
4. Set **Offset Multiplier** to 0 (zero). (Press *Aid* and *Oppose* at same time on 370.)
5. Set **Terminal Selector** to *Step Generator-Emitter Grounded*.
6. Set **Mode** to *Norm*.
7. Set **Max Peak Volts** to 15 V. (16 V on 370)
8. Set **Power Dissipation** to 10 W.

9. Set **Step Family** by depressing *Single*.

10. Set **Horizontal** knob to 2 V/DIV.

11. Set **Step/Offset Polarity** to non-inverted position (button extended, on 577 button depressed).

12. Set **Current Limit** to 500 mA (not available on 577).

13. Increase **Variable Collector Supply Voltage** until voltage reaches 12 V on CRT.

14. After 12 V setting is complete, change **Horizontal** knob to *Step Generator*.

Procedure 16: V_{GT} – Quadrant I [MT2 (+) Gate (+)]

To measure the V_{GT} – Quadrant I parameter:

1. Set **Step/Offset Amplitude** to 20% of rated V_{GT} .
2. Set **Left-Right Terminal Jack Selector** to correspond with location of test fixture.
3. Gradually increase **Offset Multiplier** until device reaches conduction point. (Figure AN1006.16) Measure V_{GT} by following horizontal axis to the point where the vertical line passes through the axis. This measured value will be V_{GT} . (On 370, V_{GT} will be numerically displayed on screen under offset value.)

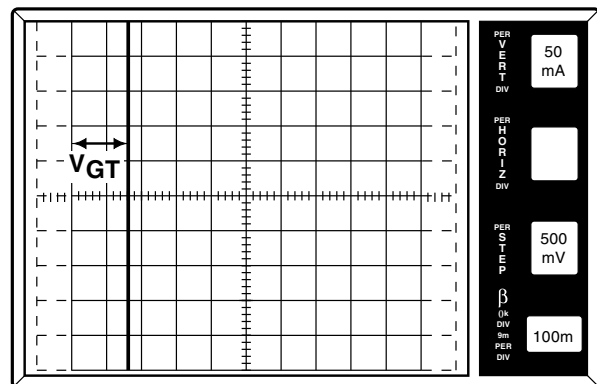

Figure AN1006.16 V_{GT} in Quadrant I = 780 mV

Procedure 17: V_{GT} – Quadrant II [MT2 (+) Gate (-)]

To measure the V_{GT} – Quadrant II parameter:

1. Set **Step/Offset Polarity** by depressing *Invert* (release button on 577).
2. Set **Polarity** to (+).
3. Set observed dot to bottom right corner of CRT grid by turning the horizontal position knob. When Quadrant II testing is complete, return dot to original position.
4. Repeat Procedure 16.

Procedure 18: V_{GT} – Quadrant III [MT2 (-) Gate (-)]

To measure the V_{GT} – Quadrant III parameter:

1. Set **Polarity** to (-).
2. Set **Step/Offset Polarity** to non-inverted position (button extended, on 577 button depressed).

3. Repeat Procedure 16. (Figure AN1006.17)

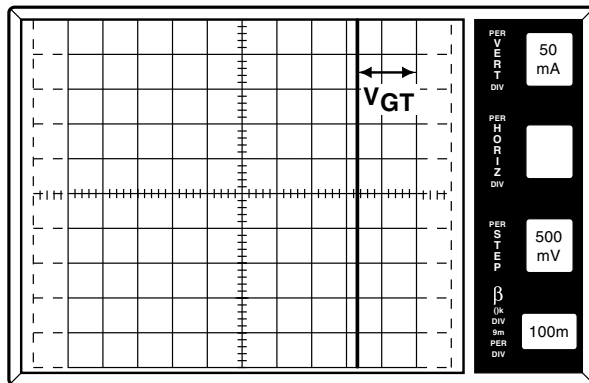

Figure AN1006.17 V_{GT} in Quadrant III = 820 mV

Procedure 19: V_{GT} – Quadrant IV [MT2 (-) Gate (+)]

To measure the V_{GT} – Quadrant IV parameter:

1. Set **Polarity** to (-).
2. Set **Step/Offset Polarity** by depressing *Invert* (release button on 577).
3. Set observed dot to top left corner of CRT grid by turning the **Horizontal** position knob. When testing is complete in Quadrant IV, return dot to original position.
4. Repeat Procedure 16.

Quadracs

Quadracs are simply triacs with an internally-mounted diac. As with triacs, *Quadracs* are bidirectional AC switches which are gate controlled for either polarity of main terminal voltage.

To connect the *Quadrac*:

1. Connect *Trigger* to *Base Terminal* (B).
2. Connect *MT1* to *Emitter Terminal* (E).
3. Connect *MT2* to *Collector Terminal* (C).

To begin testing, perform the following procedures.

Procedure 1: (+) V_{DRM} , (+) I_{DRM} , (-) V_{DRM} , (-) I_{DRM}

Note: The (+) and (-) symbols are used to designate the polarity of MT2 with reference to MT1.

To measure the (+) V_{DRM} , (+) I_{DRM} , (-) V_{DRM} , and (-) I_{DRM} parameter:

1. Set **Variable Collector Supply Voltage Range** to appropriate *Max Peak Volts* for device under test. (Value selected should be equal to or greater than the device's V_{DRM} rating).
2. Set **Horizontal** knob to sufficient scale to allow viewing of trace at the required voltage level. (The 100 V/DIV scale should be used for testing devices having a V_{DRM} rating of 600 V or greater; the 50 V/DIV scale for testing parts rated from 300 V to 500 V, and so on).
3. Set **Mode** to *Leakage*.
4. Set **Polarity** to (+).
5. Set **Power Dissipation** to 0.5 W. (0.4 W on 370)
6. Set **Terminal Selector** to *Emitter Grounded-Open Base*.

7. Set **Vertical** knob to ten times the maximum leakage current (I_{DRM}) specified for the device.

Note: The CRT readout should show 1% of the maximum leakage current. The vertical scale is divided by 1,000 when the leakage mode is used.

Procedure 2: (+) V_{DRM} and (+) I_{DRM}

To measure the (+) V_{DRM} and (+) I_{DRM} parameter:

1. Set **Left-Right Terminal Jack Selector** to correspond with the location of the test fixture.
2. Increase **Variable Collector Supply Voltage** to the rated V_{DRM} of the device and observe the dot on the CRT. (Read across horizontally from the dot to the vertical current scale.) This measured value is the leakage current. (Figure AN1006.18)

WARNING: Do NOT exceed V_{DRM}/V_{RRM} rating of SCRs, triacs, or Quadracs. These devices can be damaged.

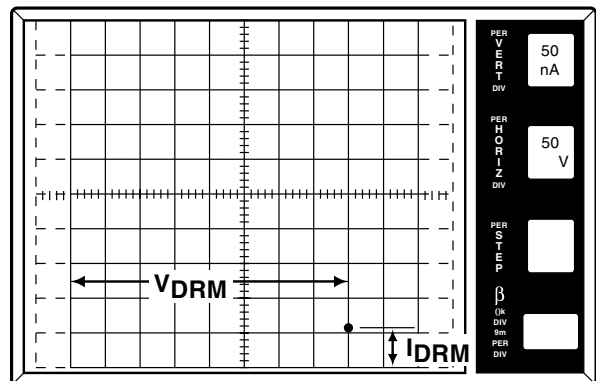

Figure AN1006.18 (+) I_{DRM} = 51 nA at (+) V_{DRM} = 400 V

Procedure 3: (-) V_{DRM} and (-) I_{DRM}

To measure the (-) V_{DRM} and (-) I_{DRM} parameter:

1. Set **Polarity** to (-).
2. Repeat Procedures 1 and 2. (Read measurements from upper right corner of screen).

Procedure 4: V_{BO} , I_{BO} , ΔV_{BO} (Quadrac Trigger Diac or Discrete Diac)

To connect the *Quadrac*:

1. Connect *MT1* to *Emitter Terminal* (E).
2. Connect *MT2* to *Collector Terminal* (C).
3. Connect *Trigger Terminal* to *MT2 Terminal* through a 10 Ω resistor.

To measure the V_{BO} , I_{BO} , and ΔV_{BO} parameter:

1. Set **Variable Collector Supply Voltage Range** to 75 *Max Peak Volts*. (80 V on 370)
2. Set **Horizontal** knob to 10 V/DIV.
3. Set **Vertical** knob to 50 μA /DIV.
4. Set **Polarity** to AC.
5. Set **Mode** to *Norm*.
6. Set **Power Dissipation** to 0.5 W. (0.4 W on 370)

7. Set **Terminal Selector** to *Emitter Grounded-Open Base*.

Procedure 5: V_{BO} (Positive and Negative)

To measure the V_{BO} (Positive and Negative) parameter:

1. Set **Left-Right Terminal Jack Selector** to correspond with the location of the test fixture.
2. Set **Variable Collector Supply Voltage** to 55 V (65 V on 370) and apply voltage to the device under test (D.U.T.) using the **Left Hand Selector Switch**. The peak voltage at which current begins to flow is the V_{BO} value. (Figure AN1006.19)

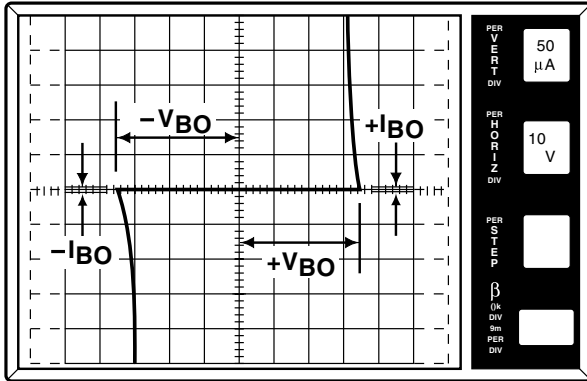

Figure AN1006.19 (+) V_{BO} = 35 V; (-) V_{BO} = 36 V; (\pm) I_{BO} < 10 A

Procedure 6: I_{BO} (Positive and Negative)

To measure the I_{BO} (Positive and Negative) parameter, at the V_{BO} point, measure the amount of device current just before the device reaches the breakover point. The measured current at this point is the I_{BO} value.

Note: If I_{BO} is less than 10 μ A, the current cannot readily be seen on curve tracer.

Procedure 7: ΔV_{BO} (Voltage Breakover Symmetry)

To measure the ΔV_{BO} (Voltage Breakover Symmetry) parameter:

1. Measure positive and negative V_{BO} values per Procedure 5.
2. Subtract the absolute value of V_{BO} (-) from V_{BO} (+).

The absolute value of the result is:

$$\Delta V_{BO} = [| +V_{BO} | - | -V_{BO} |]$$

Procedure 8: V_{TM} (Forward and Reverse)

To test V_{TM} , the *Quadrac* must be connected the same as when testing V_{BO} , I_{BO} , and ΔV_{BO} .

To connect the *Quadrac*:

1. Connect *MT1* to *Emitter Terminal* (E).
2. Connect *MT2* to *Collector Terminal* (C).
3. Connect *Trigger Terminal* to *MT2 Terminal* through a 10 Ω resistor.

Note the following:

- Due to the excessive amount of power that can be generated in this test, only parts with an $I_{T(RMS)}$ rating of 8 A or less should be tested on standard curve tracer. If testing devices above 8 A, a Tektronix model 176 high-current module is required.

- A Kelvin test fixture is required for this test. If a Kelvin fixture is not used, an error in measurement of V_{TM} will result due to voltage drop in fixture. If a Kelvin fixture is not available, Figure AN1006.3 shows necessary information to wire a test fixture with Kelvin connections.

To measure the V_{TM} (Forward and Reverse) parameter:

1. Set **Terminal Selector** to *Emitter Grounded-Open Base*.
2. Set **Max Peak Volts** to 75 V. (80 V on 370)
3. Set **Mode** to *Norm*.
4. Set **Horizontal knob** to 0.5 V/DIV.
5. Set **Power Dissipation** to 220 watts (100 watts on a 577).
6. Set **Vertical knob** to a sufficient setting to allow the viewing of 1.4 times the $I_{T(RMS)}$ rating of the device $I_{T(peak)}$ on the CRT.

Procedure 9: V_{TM} (Forward)

To measure the V_{TM} (Forward) parameter:

1. Set **Polarity** to (+).
2. Set **Left-Right Terminal Jack Selector** to correspond with the location of the test fixture.
3. Increase **Variable Collector Supply Voltage** until current reaches rated $I_{T(peak)}$, which is 1.4 times the $I_{T(RMS)}$ rating of the triac under test.

Note: Model 370 current is limited to 10 A.

WARNING: Limit test time to 15 seconds maximum.

4. To measure V_{TM} , follow along horizontal scale to the point where the trace crosses the $I_{T(peak)}$ value. This horizontal distance is the V_{TM} value. (Figure AN1006.20)

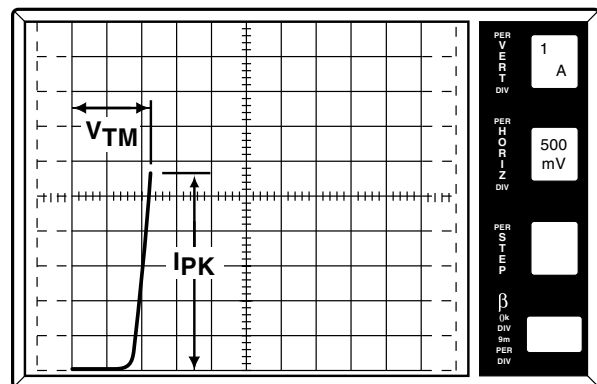

Figure AN1006.20 V_{TM} (Forward) = 1.1 V at I_{PK} = 5.6 A

Procedure 10: V_{TM} (Reverse)

To measure the V_{TM} (Reverse) parameter:

1. Set **Polarity** to (-).
2. Set **Left-Right Terminal Jack Selector** to correspond with the location of the test fixture.
3. Increase **Variable Collector Supply Voltage** until current reaches rated $I_{T(peak)}$.
4. Measure V_{TM} (Reverse) the same as in Procedure 8. (Read measurements from upper right corner of screen).

Procedure 11: $I_{H(\text{Forward and Reverse})}$

For these steps, it is again necessary to connect the *Trigger* to *MT2* through a $10\ \Omega$ resistor. The other connections remain the same.

To measure the $I_{H(\text{Forward and Reverse})}$ parameter:

1. Set **Power Dissipation** to *50 W*.
2. Set **Max Peak Volts** to *75 V*. (*80 V* on 370)
3. Set **Mode** to *DC*.
4. Set **Horizontal** knob to *5 V/DIV*.
5. Set **Vertical** knob to approximately 10% of the maximum I_H specified.

Note: Due to large variations of holding current values, the scale may have to be adjusted to observe holding current.

6. Set **Terminal Selector** to *Emitter Grounded-Open Base*.

Procedure 12: $I_{H(\text{Forward})}$

To measure the $I_{H(\text{Forward})}$ parameter:

1. Set **Polarity** to (+).
2. Set **Left-Right Terminal Jack Selector** to correspond with the location of the test fixture.
3. Increase **Variable Collector Supply Voltage** to maximum position (*100*).

Note: Depending on the vertical scale being used, the dot may disappear completely from the screen.

4. Decrease **Variable Collector Supply Voltage** to the point where the line on the CRT changes to a dot. The position of the beginning point of the line, just before the line changes to a dot, represents the I_H value. (Figure AN1006.21)

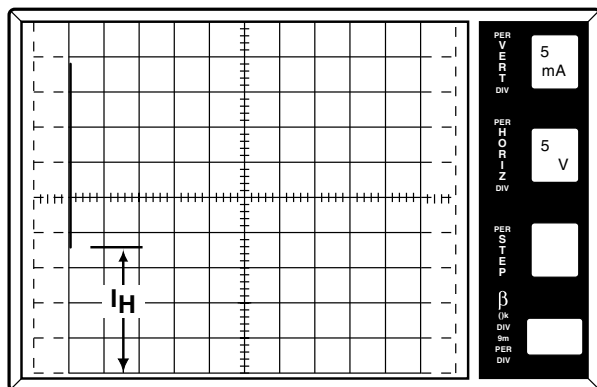

Figure AN1006.21 $I_{H(\text{Forward})} = 18\ \text{mA}$

Procedure 13: $I_{H(\text{Reverse})}$

To measure the $I_{H(\text{Reverse})}$ parameter:

1. Set **Polarity** to (-).
2. Continue testing per Procedure 12 for measuring $I_{H(\text{Reverse})}$.

Sidacs

The sidac is a bidirectional voltage-triggered switch. Upon application of a voltage exceeding the sidac breakover voltage point, the sidac switches on through a negative resistance region (similar to a diac) to a low on-state voltage. Conduction continues until current is interrupted or drops below minimum required holding current.

To connect the sidac:

1. Connect *MT1* to the *Emitter Terminal (E)*.
2. Connect *MT2* to the *Collector Terminal (C)*.

To begin testing, perform the following procedures.

Procedure 1: (+) V_{DRM} , (+) I_{DRM} , (-) V_{DRM} , (-) I_{DRM}

Note: The (+) and (-) symbols are used to designate the polarity of *MT2* with reference to *MT1*.

To measure the (+) V_{DRM} , (+) I_{DRM} , (-) V_{DRM} , and (-) I_{DRM} parameter:

1. Set **Variable Collector Supply Voltage Range** to *1500 Max Peak Volts*.
2. Set **Horizontal** knob to *50 V/DIV*.
3. Set **Mode** to *Leakage*.
4. Set **Polarity** to (+).
5. Set **Power Dissipation** to *2.2 W*. (*2 W* on 370)
6. Set **Terminal Selector** to *Emitter Grounded-Open Base*.
7. Set **Vertical** knob to *50 $\mu\text{A}/\text{DIV}$* . (Due to leakage mode, the CRT readout will show 50 nA.)

Procedure 2: (+) V_{DRM} and (+) I_{DRM}

To measure the (+) V_{DRM} and (+) I_{DRM} parameter:

1. Set **Left-Right Terminal Jack Selector** to correspond with the location of the test fixture.
2. Increase **Variable Collector Supply Voltage** to the rated V_{DRM} of the device and observe the dot on the CRT. Read across horizontally from the dot to the vertical current scale. This measured value is the leakage current. (Figure AN1006.22)

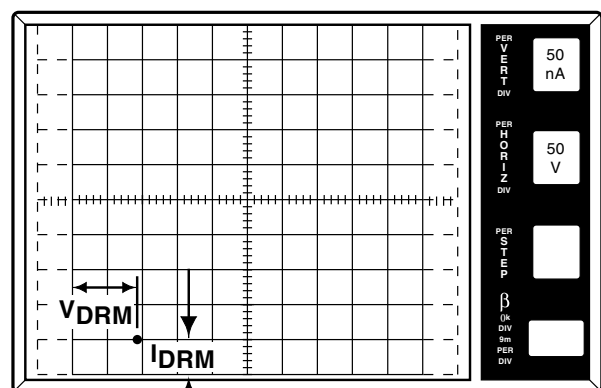

Figure AN1006.22 $I_{\text{DRM}} = 50\ \text{nA}$ at $V_{\text{DRM}} = 90\ \text{V}$

Procedure 3: (-) V_{DRM} and (-) I_{DRM}

To measure the (-) V_{DRM} and (-) I_{DRM} parameter:

1. Set **Polarity** to (-).
2. Repeat Procedures 1 and 2. (Read measurements from upper right corner of the screen).

Procedure 4: V_{BO} and I_{BO}

To measure the V_{BO} and I_{BO} parameter:

1. Set **Variable Collector Supply Voltage Range** to *1500 Max Peak Volts*. (2000 V on 370)
2. Set **Horizontal** knob to a sufficient scale to allow viewing of trace at the required voltage level (**50 V/DIV** for 95 V to 215 V V_{BO} range devices and **100 V/DIV** for devices having $V_{BO} \geq 15$ V).
3. Set **Vertical** knob to **50 μ A/DIV**.
4. Set **Polarity** to AC.
5. Set **Mode** to *Norm*.
6. Set **Power Dissipation** to **10 W**.
7. Set **Terminal Selector** to *Emitter Grounded-Open Base*.
8. Set **Left-Right Terminal Jack Selector** to correspond with location of test fixture.

Procedure 5: V_{BO}

To measure the V_{BO} parameter, increase **Variable Collector Supply Voltage** until breakover occurs. (Figure AN1006.23) The voltage at which current begins to flow and voltage on CRT does not increase is the V_{BO} value.

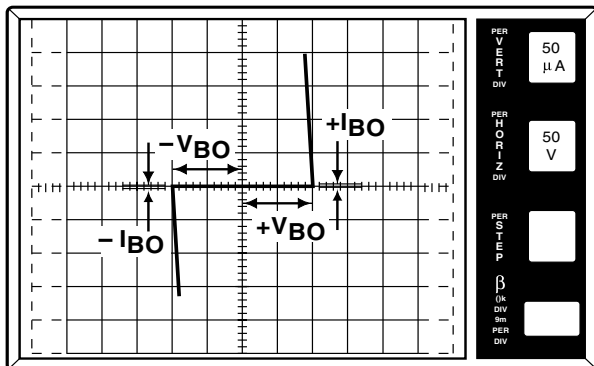

Figure AN1006.23 (+) V_{BO} = 100 V; (-) V_{BO} = 100 V; (\pm) I_{BO} < 10 μ A

Procedure 6: I_{BO}

To measure the I_{BO} parameter, at the V_{BO} point, measure the amount of device current just before the device reaches the breakover mode. The measured current at this point is the I_{BO} value.

Note: If I_{BO} is less than 10 μ A, the current cannot readily be seen on the curve tracer.

Procedure 7: I_H (Forward and Reverse)

To measure the I_H (Forward and Reverse) parameter:

1. Set **Variable Collector Supply Voltage Range** to *1500 Max Peak Volts* (400 V on 577; 2000 V on 370).
 2. Set **Horizontal** knob to a sufficient scale to allow viewing of trace at the required voltage level (**50 V/DIV** for devices with V_{BO} range from 95 V to 215 V and **100 V/DIV** for devices having $V_{BO} \geq 215$ V).
 3. Set **Vertical** knob to 20% of maximum holding current specified.
 4. Set **Polarity** to AC.
 5. Set **Mode** to *Norm*.
 6. Set **Power Dissipation** to **220 W** (100 W on 577).
 7. Set **Terminal Selector** to *Emitter Grounded-Open Base*.
 8. Set **Left-Right Terminal Jack Selector** to correspond with the location of the test fixture.
- WARNING: Limit test time to 15 seconds maximum.**
9. Increase **Variable Collector Supply Voltage** until device breaks over and turns on. (Figure AN1006.24)

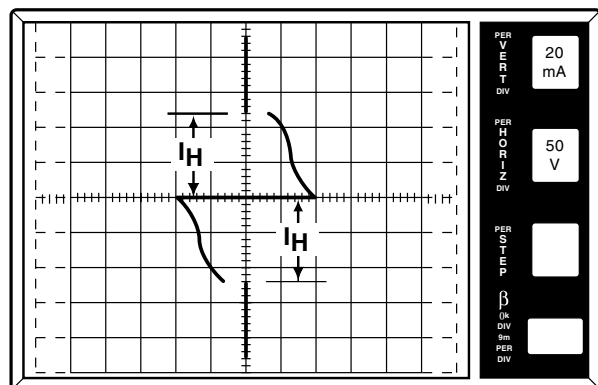

Figure AN1006.24 I_H = 48 mA in both forward and reverse directions

I_H is the vertical distance between the center horizontal axis and the beginning of the line located on center vertical axis.

Procedure 8: V_{TM} (Forward and Reverse)

To measure the V_{TM} (Forward and Reverse) parameter:

1. Set **Variable Collector Supply Voltage Range** to *350 Max Peak Volts*. (400 V on 370)
2. Set **Horizontal** knob to **0.5 V/DIV**.
3. Set **Vertical** knob to **0.5 A/DIV**.
4. Set **Polarity** to (+).
5. Set **Mode** to *Norm*.
6. Set **Power Dissipation** to **220 W** (100 W on 577).
7. Set **Terminal Selector** to *Emitter Grounded-Open Base*.

Before continuing with testing, note the following:

- A Kelvin test fixture is required for this test. If a Kelvin fixture is not used, an error in measurement of V_{TM} will result due to voltage drop in fixture. If a Kelvin fixture is not available, Figure AN1006.3 shows necessary information to wire a test fixture with Kelvin Connections.

To continue testing, perform the following procedures.

Procedure 9: $V_{TM(Forward)}$

To measure the $V_{TM(Forward)}$ parameter:

1. Set **Left-Right Terminal Jack Selector** to correspond with the location of the test fixture.
2. Increase **Variable Collector Supply Voltage** until current reaches rated $I_{T(peak)}$, which is 1.4 times the $I_{T(RMS)}$ rating of the sidac.

Note: Model 370 current is limited. Set to 400 mA. Check for 1.1 V MAX.

WARNING: Limit test time to 15 seconds.

3. To measure V_{TM} , follow along horizontal scale to the point where the trace crosses the $I_{T(peak)}$ value. This horizontal distance is the V_{TM} value. (Figure AN1006.25)

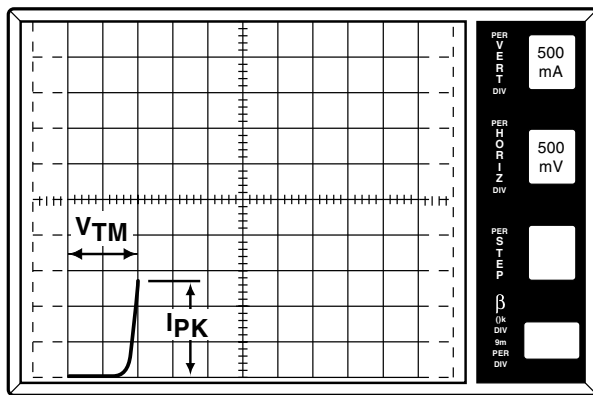

Figure AN1006.25 $V_{TM(Forward)} = 950 \text{ mV}$ at $I_{PK} = 1.4 \text{ A}$

Procedure 10: $V_{TM(Reverse)}$

To measure the $V_{TM(Reverse)}$ parameter:

1. Set **Polarity** to (-).
2. Repeat Procedure 8 to measure $V_{TM(Reverse)}$.

Diacs

Diacs are voltage breakdown switches used to trigger-on triacs and non-sensitive SCRs in phase control circuits.

Note: Diacs are bi-directional devices and can be connected in either direction.

To connect the diac:

1. Connect one side of the diac to the *Collector Terminal* (C).
2. Connect other side of the diac to the *Emitter Terminal* (E).

To begin testing, perform the following procedures.

Procedure 1: Curve Tracer Setup

To set the curve tracer and begin testing:

1. Set **Variable Collector Supply Voltage Range** to *75 Max Peak Volts*. (80 V on 370)
2. Set **Horizontal** knob to sufficient scale to allow viewing of trace at the required voltage level (10 V to 20 V/DIV depending on device being tested).

3. Set **Vertical** knob to *50 $\mu\text{A}/\text{DIV}$* .
4. Set **Polarity** to *AC*.
5. Set **Mode** to *Norm*.
6. Set **Power Dissipation** to *0.5 W*. (0.4 W on 370)
7. Set **Terminal Selector** to *Emitter Grounded-Open Base*.

Procedure 2: V_{BO}

To measure the V_{BO} parameter:

1. Set **Left-Right Terminal Jack Selector** to correspond with the location of the test fixture.
2. Set **Variable Collector Supply Voltage** to *55 V* (65 V for 370) and apply voltage to device under test (D.U.T.), using **Left-Right-Selector Switch**. The peak voltage at which current begins to flow is the V_{BO} value. (Figure AN1006.26)

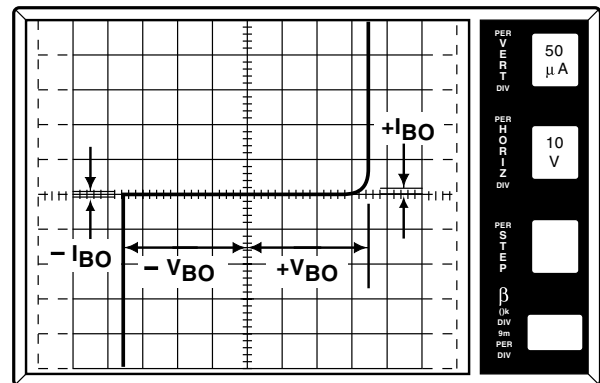

Figure AN1006.26 (+) $V_{BO} = 35 \text{ V}$; (-) $V_{BO} = 36 \text{ V}$; (\pm) $I_{BO} < 15 \mu\text{A}$; (-) $I_{BO} < 10 \mu\text{A}$ and Cannot Be Read Easily

Procedure 3: I_{BO}

To measure the I_{BO} parameter, at the V_{BO} point, measure the amount of device current just before the device reaches the breakover mode. The measured current at this point is the I_{BO} value.

Note: If I_{BO} is less than $10 \mu\text{A}$, the current cannot readily be seen on the curve tracer.

Procedure 4: ΔV_{BO} (Voltage Breakover Symmetry)

To measure the ΔV_{BO} (Voltage Breakover Symmetry) parameter:

1. Measure positive and negative values of V_{BO} as shown in Figure AN1006.26.
2. Subtract the absolute value of $V_{BO(-)}$ from $V_{BO(+)}$.

The absolute value of the result is:

$$\Delta V_{BO} = [| +V_{BO} | - | -V_{BO} |]$$

Model 370 Curve Tracer Procedure Notes

Because the curve tracer procedures in this application note are written for the Tektronix model 576 curve tracer, certain settings must be adjusted when using model 370. Variable Collector Supply Voltage Range and Power Dissipation controls have different scales than model 576. The following table shows the guidelines for setting Power Dissipation when using model 370.

(Figure AN1006.27)

Model 576	Model 370
If power dissipation is 0.1 W,	set at 0.08 W.
If power dissipation is 0.5 W,	set at 0.4 W.
If power dissipation is 2.2 W,	set at 2 W.
If power dissipation is 10 W,	set at 10 W.
If power dissipation is 50 W,	set at 50 W.
If power dissipation is 220 W,	set at 220 W.

Although the maximum power setting on the model 370 curve tracer is 200 W, the maximum collector voltage available is only 400 V at 220 W. The following table shows the guidelines for adapting Collector Supply Voltage Range settings for model 370 curve tracer procedures:

Model 576	Model 370
If voltage range is 15 V,	set at 16 V.
If voltage range is 75 V,	set at 80 V.
If voltage range is 350 V,	set at 400 V.
If voltage range is 1500 V,	set at 2000 V.

The following table shows the guidelines for adapting terminal selector knob settings for model 370 curve tracer procedures:

Model 576	Model 370
If Step generator (base) is emitter grounded,	then Base Step generator is emitter common.
If Emitter grounded is open base,	then Base open is emitter common.

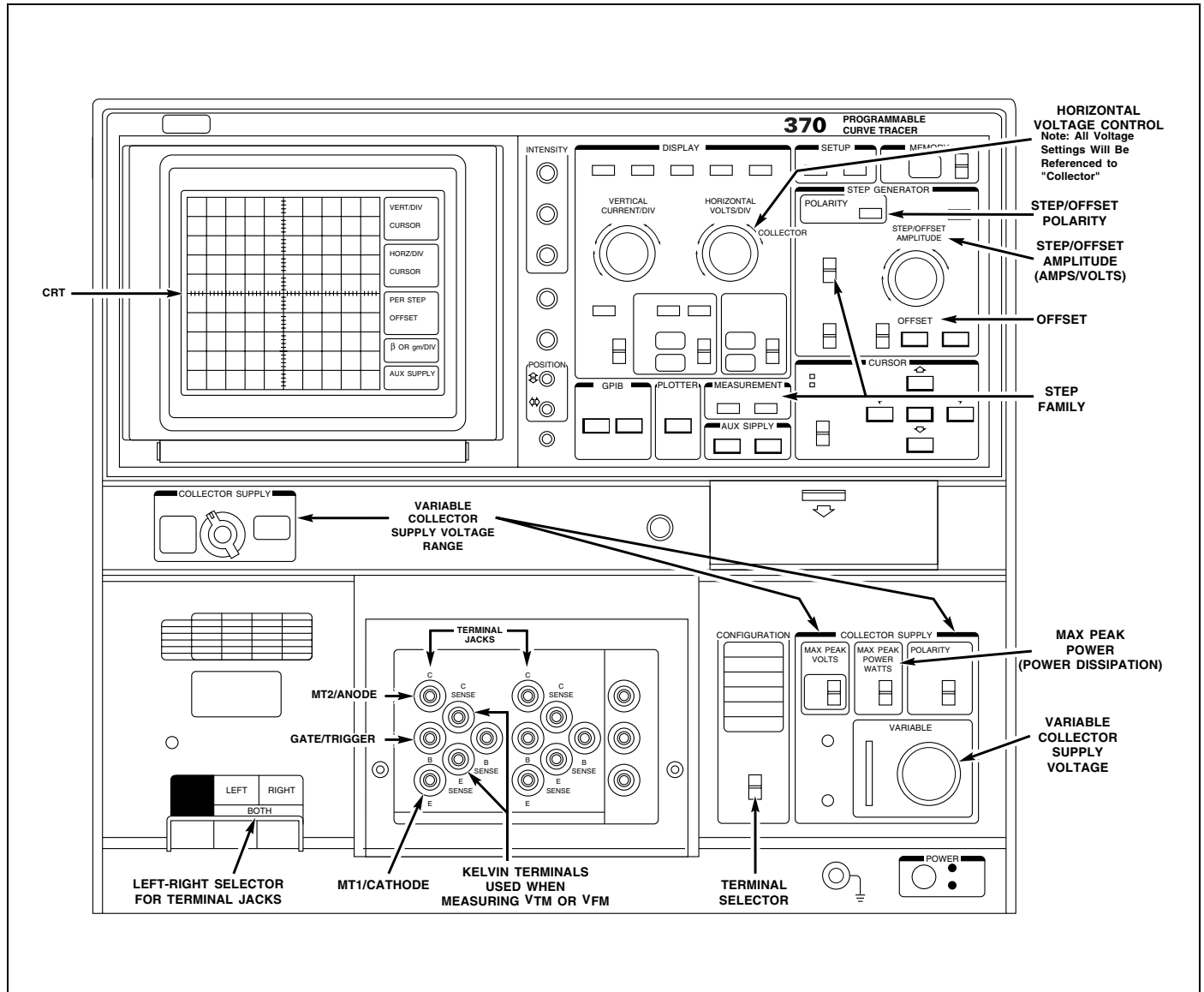

Figure AN1006.27 Tektronix Model 370 Curve Tracer

Model 577 Curve Tracer Procedure Notes

Because the curve tracer procedures in this application note are written for the Tektronix model 576 curve tracer, certain settings must be adjusted when using model 577. Model 576 curve tracer has separate controls for polarity (AC,+, -) and mode (Norm, DC, Leakage), whereas Model 577 has only a polarity control. The following table shows the guidelines for setting Collector Supply Polarity when using model 577. (Figure AN1006.28)

Model 576	Model 577
If using Leakage mode along with polarity setting of +(NPN) and -(PNP), [vertical scale divided by 1,000],	set Collector Supply Polarity to either +DC or -DC, depending on polarity setting specified in the procedure. The vertical scale is read directly from the scale on the control knob.
If using DC mode along with either +(NPN) or -(PNP) polarity,	set Collector Supply Polarity to either +DC or -DC depending on polarity specified.
If using Norm mode along with either +(NPN) or -(PNP) polarity,	set Collector Supply Polarity to either +(NPN) or -(PNP) per specified procedure.
If using Norm mode with AC polarity,	set Collector Supply Polarity to AC.

One difference between models 576 and 577 is the Step/Offset Polarity setting. The polarity is inverted when the button is depressed on the Model 576 curve tracer. The Model 577 is opposite — the Step/Offset Polarity is “inverted” when the button is extended and “Normal” when the button is depressed. The Step/Offset Polarity is used only when measuring I_{GT} and V_{GT} of triacs and *Quadracs* in Quadrants I through IV.

Also, the Variable Collector Supply Voltage Range and Power Dissipation controls have different scales than model 576. The following table shows the guidelines for setting Power Dissipation when using model 577.

Model 576	Model 577
If power dissipation is 0.1 W,	set at 0.15 W.
If power dissipation is 0.5 W,	set at 0.6 W.
If power dissipation is 2.2 W,	set at 2.3 W.
If power dissipation is 10 W,	set at 9 W.
If power dissipation is 50 W,	set at 30 W.
If power dissipation is 220 W,	set at 100 W.

Although the maximum power setting on model 576 curve tracer is 220 W (compared to 100 W for model 577), the maximum collector current available is approximately the same. This is due to the minimum voltage range on model 577 curve tracer being 6.5 V compared to 15 V for model 576. The following table shows the guidelines for adapting Collector Voltage Supply Range settings for model 577 curve tracer procedures:

Model 576	Model 577
If voltage range is 15 V,	set at either 6.5 V or 25 V, depending on parameter being tested. Set at 6.5 V when measuring V_{TM} (to allow maximum collector current) and set at 25 V when measuring I_{GT} and V_{GT} .
If voltage range is 75 V,	set at 100 V.
If voltage range is 1500 V,	set at 1600 V.

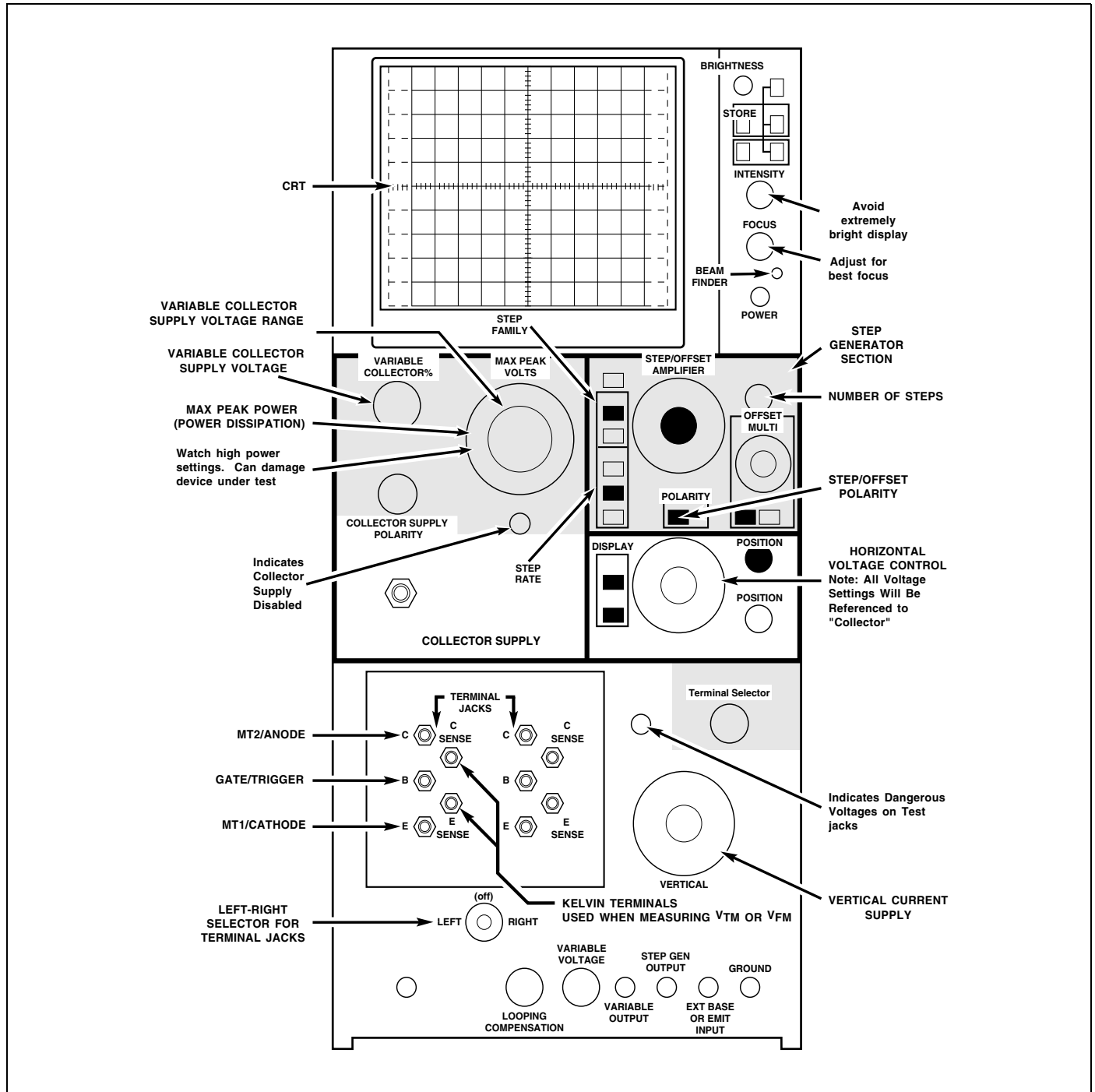

Figure AN1006.28 Tektronix Model 577 Curve Tracer

Notes

Thyristors Used as AC Static Switches and Relays

Introduction

Since the SCR and the triac are bistable devices, one of their broad areas of application is in the realm of signal and power switching. This application note describes circuits in which these thyristors are used to perform simple switching functions of a general type that might also be performed non-statically by various mechanical and electromechanical switches. In these applications, the thyristors are used to open or close a circuit completely, as opposed to applications in which they are used to control the magnitude of average voltage or energy being delivered to a load. These latter types of applications are described in detail in "Phase Control Using Thyristors" (AN1003).

Static AC Switches

Normally Open Circuit

The circuit shown in Figure AN1007.1 provides random (anywhere in half-cycle), fast turn-on ($<10 \mu\text{s}$) of AC power loads and is ideal for applications with a high-duty cycle. It eliminates completely the contact sticking, bounce, and wear associated with conventional electromechanical relays, contactors, and so on. As a substitute for control relays, thyristors can overcome the differential problem; that is, the spread in current or voltage between pickup and dropout because thyristors effectively drop out every half cycle. Also, providing resistor R_1 is chosen correctly, the circuits are operable over a much wider voltage range than is a comparable relay. Resistor R_1 is provided to limit gate current (I_{GTM}) peaks. Its resistance plus any contact resistance (R_C) of the control device and load resistance (R_L) should be just greater than the peak supply voltage divided by the peak gate current rating of the triac. If R_1 is set too high, the triacs may not trigger at the beginning of each cycle, and phase control of the load will result with consequent loss of load voltage and waveform distortion. For inductive loads, an RC snubber circuit, as shown in Figure AN1007.1, is required. However, a snubber circuit is not required when an alternistor is used.

Figure AN1007.2 illustrates an analysis to better understand a typical static switch circuit. The circuit operation occurs when switch S_1 is closed, since the triac Q_1 will initially be in the blocking condition. Current flow will be through load R_L , S_1 , R_1 , and gate to MT1 junction of the thyristor. When this current reaches the required value of I_{GT} , the MT2 to MT1 junctions will switch to the conduction state and the voltage from MT2 to MT1 will be V_T . As the current approaches the zero crossing, the load current will fall below holding current turning the triac Q_1 device off until it is refired in the next half cycle. Figure AN1007.3 illustrates the voltage waveform appearing across the MT2 to MT1 terminals of Q_1 . Note that the maximum peak value of current which S_1 will carry

would be 25 mA since Q_1 has a 25 mA maximum I_{GT} rating. Additionally, no arcing of a current value greater than 25 mA when opening S_1 will occur when controlling an inductive load. It is important also to note that the triac Q_1 is operating in Quadrants I and III, the more sensitive and most suitable gating modes for triacs. The voltage rating of S_1 (mechanical switch or reed switch) must be equivalent to or greater than line voltage applied.

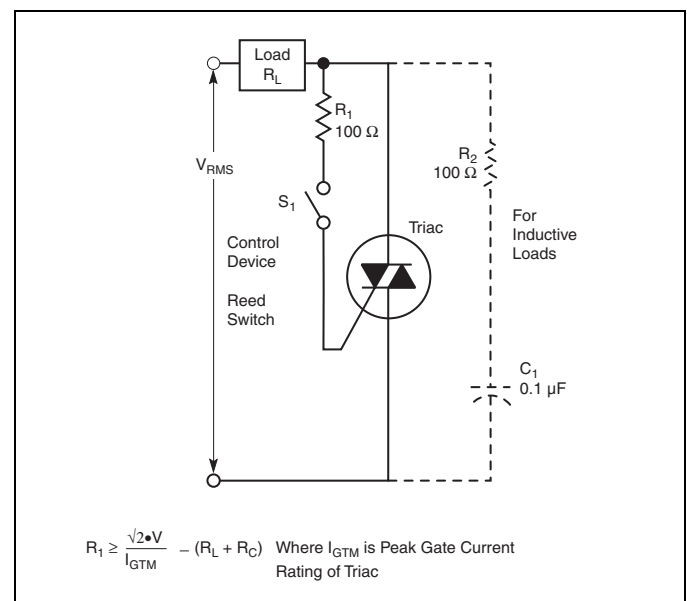

Figure AN1007.1 Basic Triac Static Switch

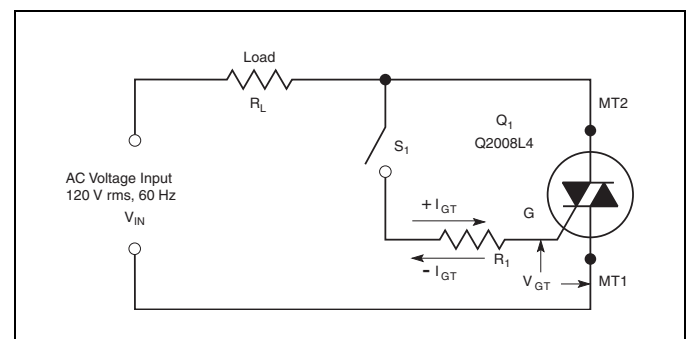

Figure AN1007.2 Analysis of Static Switch

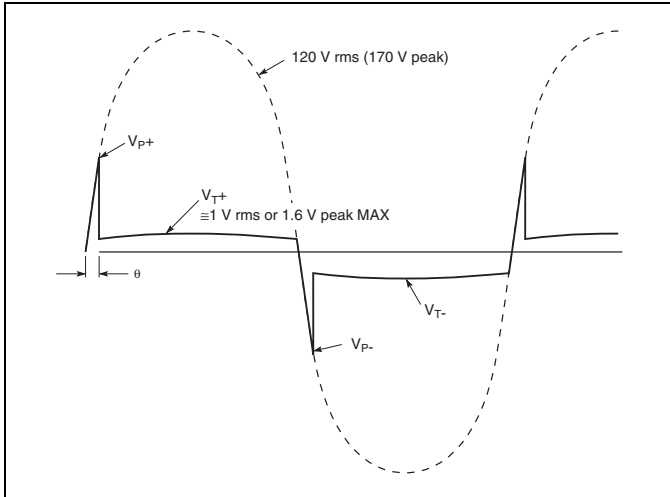

Figure AN1007.3 Waveform Across Static Switch

A typical example would be in the application of this type circuit for the control of 5 A resistive load with 120 V rms input voltage. Choosing a value of 100 Ω for R_1 and assuming a typical value of 1 V for the gate to MT1 (V_{GT}) voltage, we can solve for V_P by the following:

$$V_P = I_{GT} (R_L + R_1) + V_{GT}$$

Note: R_C is not included since it is negligible.

$$V_P = 0.025 (24 + 100) + 1.0 = 4.1 \text{ V}$$

Additionally the turn-on angle is

$$\theta = \sin^{-1} \frac{4.1}{170 V_{PK}} \quad [\theta = 1.4^\circ]$$

The power lost by the turn-on angle is essentially zero. The power dissipation in the gate resistor is very minute. A 100 Ω , 0.25 W rated resistor may safely be used. The small turn-on angle also ensures that no appreciable RFI is generated.

The relay circuit shown in Figure AN1007.1 and Figure AN1007.2 has several advantages in that it eliminates contact bounce, noise, and additional power consumption by an energizing coil and can carry an in-rush current of many times its steady state rating.

The control device S_1 indicated can be either electrical or mechanical in nature. Light-dependent resistors and light-activated semiconductors, optocoupler, magnetic cores, and magnetic reed switches are all suitable control elements. Regardless of the switch type chosen, it must have a voltage rating equal to or greater than the peak line voltage applied. In particular, the use of hermetically sealed reed switches as control elements in combination with triacs offers many advantages. The reed switch can be actuated by passing DC current through a small coiled wire or by the proximity of a small magnet. In either case, complete electrical isolation exists between the control signal input, which may be derived from many sources, and the switched power output. Long life of the triac/reed switch combination is ensured by the minimal volt-ampere switching load placed on the reed switch by the triac triggering requirements. The thyristor ratings determine the amount of load power that can be switched.

Normally Closed Circuit

With a few additional components, the thyristor can provide a normally closed static switch function. The critical design portion of this static switch is a clamping device to turn off/eliminate gate drive and maintain very low power dissipation through the clamping component plus have low by-pass leakage around the power thyristor device. In selecting the power thyristor for load requirements, gate sensitivity becomes critical to maintain low power requirements. Either sensitive SCRs or sensitive logic triacs must be considered, which limits the load in current capacity and type. However, this can be broader if an extra stage of circuitry for gating is permitted.

Figure AN1007.4 illustrates an application using a normally closed circuit driving a sensitive SCR for a simple but precise temperature controller. The same basic principle could be applied to a water level controller for a motor or solenoid. Of course, SCR and diode selection would be changed depending on load current requirements.

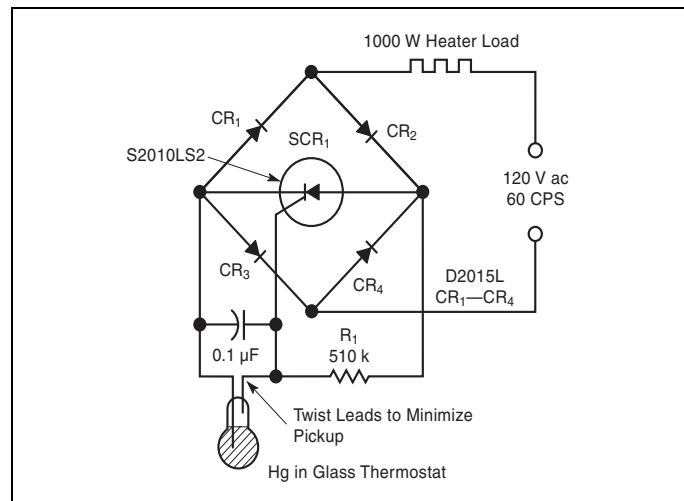

Figure AN1007.4 Normally Closed Temperature Controller

A mercury-in-glass thermostat is an extremely sensitive measuring instrument, capable of sensing changes in temperature as small as 0.1 $^\circ\text{C}$. Its major limitation lies in its very low current-handling capability for reliability and long life, and contact current should be held below 1 mA. In the circuit of Figure AN1007.4, the S2010LS2 SCR serves as both current amplifier for the Hg thermostat and as the main load switching element.

With the thermostat open, the SCR will trigger each half cycle and deliver power to the heater load. When the thermostat closes, the SCR can no longer trigger and the heater shuts off. Maximum current through the thermostat in the closed position is less than 250 μA rms.

Figure AN1007.5 shows an all solid state, optocoupled, normally closed switch circuit. By using a low voltage SBS triggering device, this circuit can turn on with only a small delay in each half cycle and also keep gating power low. When the optocoupled transistor is turned on, the gate drive is removed with only a few milliamps of bypass current around the triac power device. Also, by use of the BS08D and 0.1 μF , less sensitive triacs and alternators can be used to control various types of high current loads.

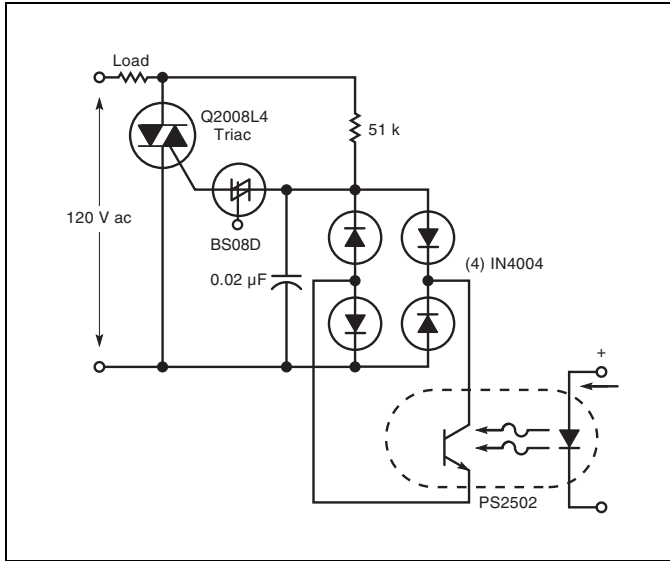

Figure AN1007.5 Normally Closed Switch Circuit

Optocoupled Driver Circuits

Random Turn-on, Normally Open

Many applications use optocouplers to drive thyristors. The combination of a good optocoupler and a triac or alternistor makes an excellent, inexpensive solid state relay. Application information provided by the optocoupler manufacturers is not always best for application of the power thyristor. Figure AN1007.6 shows a standard circuit for a resistive load.

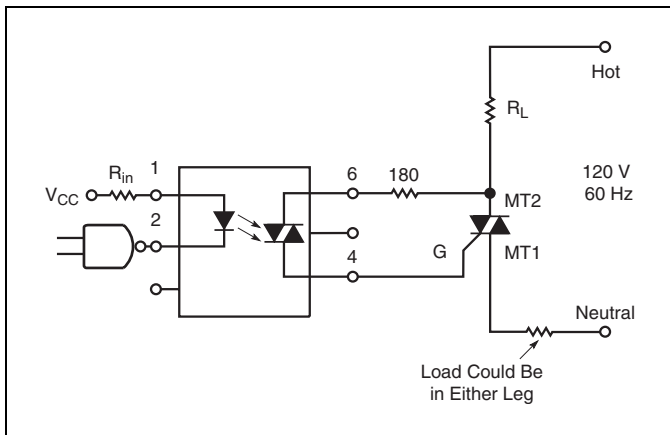

Figure AN1007.6 Optocoupled Circuit for Resistive Loads (Triac or Alternistor)

A common mistake in this circuit is to make the series gate resistor too large in value. A value of 180 Ω is shown in a typical application circuit by optocoupler manufacturers. The 180 Ω is based on limiting the current to 1 A peak at the peak of a 120 V line input. This is good for protection of the optocoupler output triac, as well as the gate of the power triac on a 120 V line; however, it must be lowered if a 24 V line is being controlled, or if the R_L (resistive load) is 200 W or less. This resistor limits current for worst case turn-on at the peak line voltage, but it also sets turn-on point (conduction angle) in the sine wave, since triac gate current is determined by this resistor and produced from the sine

wave voltage as illustrated in Figure AN1007.2. The load resistance is also important, since it can also limit the amount of available triac gate current. A 100 Ω gate resistor would be a better choice in most 120 V applications with loads greater than 200 W and optocouplers from Quality Technologies or Vishay with optocoupler output triacs that can handle 1.7 A_{PK} (I_{TSM} rating) for a few microseconds at the peak of the line. For loads less than 200 W, the resistor can be dropped to 22 Ω. Remember that if the gate resistor is too large in value, the triac will not turn on at all or not turn on fully, which can cause excessive power dissipation in the gate resistor, causing it to burn out. Also, the voltage and dv/dt rating of the optocoupler's output device must be equal to or greater than the voltage and dv/dt rating of the triac or alternistor it is driving.

Figure AN1007.7 illustrates a circuit with a dv/dt snubber network included. This is a typical circuit presented by optocoupler manufacturers.

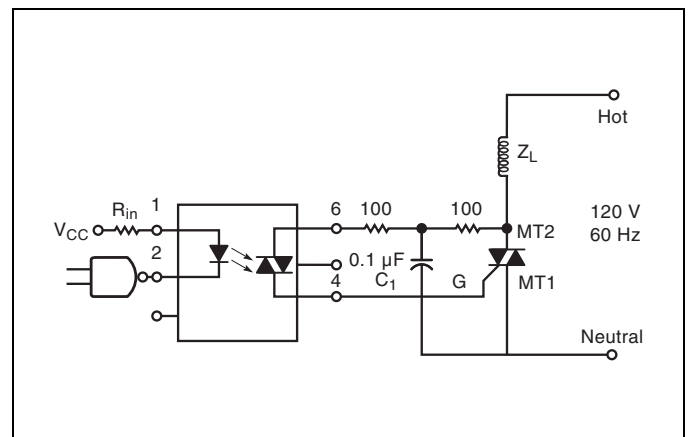

Figure AN1007.7 Optocoupler Circuit for Inductive Loads (Triac or Alternistor)

This "T" circuit hinges around one capacitor to increase dv/dt capability to either the optocoupler output triac or the power triac. The sum of the two resistors then forms the triac gate resistor.

Both resistors should then be standardized and lowered to 100 Ω. Again, this sum resistance needs to be low, allowing as much gate current as possible without exceeding the instantaneous current rating of the opto output triac or triac gate junction. By having 100 Ω for current limit in either direction from the capacitor, the optocoupler output triac and power triac can be protected against di/dt produced by the capacitor. Of course, it is most important that the capacitor be connected between proper terminals of triac. For example, if the capacitor and series resistor are accidentally connected between the gate and MT2, the triac will turn on from current produced by the capacitor, resulting in loss of control.

For low current (mA) and/or highly inductive loads, it may be necessary to have a latching network (3.3 kΩ + 0.047 μF) connected directly across the power triac. The circuit shown in Figure AN1007.8 illustrates the additional latching network.

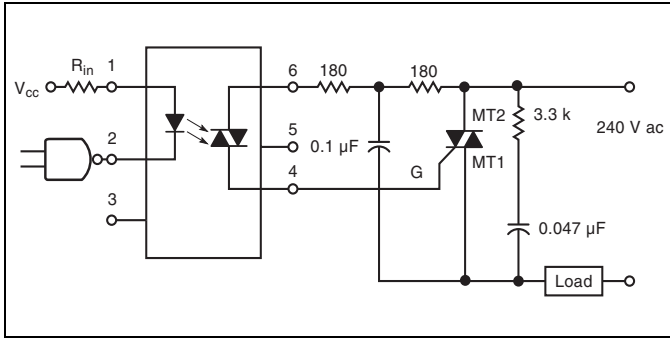

Figure AN1007.8 Optocoupler Circuit for Lower Current Inductive Loads (Triac or Alternistor)

In this circuit, the series gate resistors are increased to 180 Ω each, since a 240 V line is applied. Note that the load is placed on the MT1 side of the power triac to illustrate that load placement is **not** important for the circuit to function properly.

Also note that with standard U.S. residential 240 V home wiring, both sides of the line are hot with respect to ground (no neutral). Therefore, for some 240 V line applications, it will be necessary to have a triac switch circuit in both sides of the 240 V line input.

If an application requires back-to-back SCRs instead of a triac or alternistor, the circuit shown in Figure AN1007.9 may be used.

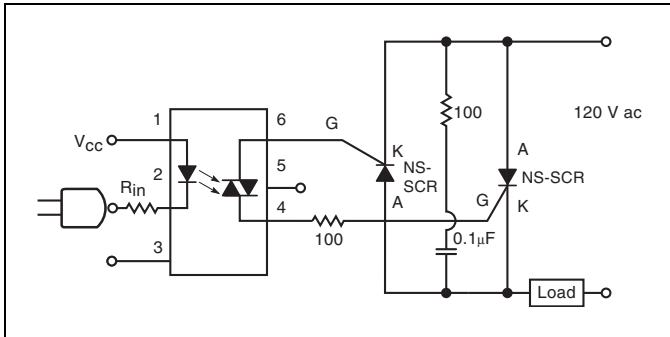

Figure AN1007.9 Optocoupled Circuit for Heavy-duty Inductive Loads

All application comments and recommendations for optocoupled switches apply to this circuit. However, the snubber network can be applied only across the SCRs as shown in the illustration. The optocoupler should be chosen for best noise immunity. Also, the voltage rating of the optocoupler output triac must be equal to or greater than the voltage rating of SCRs.

Summary of Random Turn-on Relays

As shown in Figure AN1007.10, if the voltage across the load is to be phase controlled, the input control circuitry must be synchronized to the line frequency and the trigger pulses delayed from zero crossing every half cycle. If the series gate resistor is chosen to limit the peak current through the opto-driver to less than 1 A, then on a 120 V ac line the peak voltage is 170 V; therefore, the resistor is 180 Ω. On a 240 V ac line the peak voltage is 340 V; therefore, the resistor should be 360 Ω. These gate pulses are only as long as the device takes to turn on (typically, 5 μs to 6 μs); therefore, 0.25 W resistor is adequate.

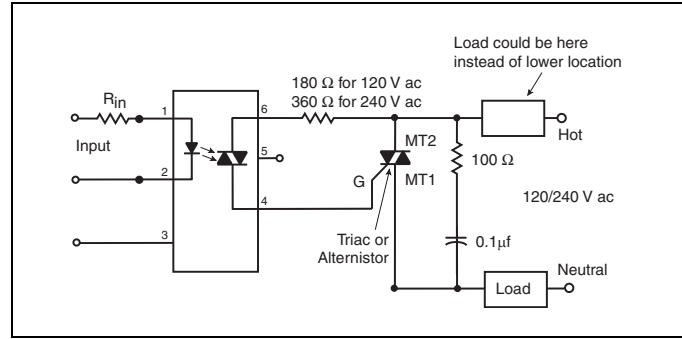

Figure AN1007.10 Random Turn-on Triac Driver

Select the triac for the voltage of the line being used, the current through the load, and the type of load. Since the peak voltage of a 120 V ac line is 170 V, you would choose a 200 V (MIN) device. If the application is used in an electrically noisy industrial environment, a 400 V device should be used. If the line voltage to be controlled is 240 V ac with a peak voltage of 340 V, then use at least a 400 V rated part or 600 V for more design margin. Selection of the voltage rating of the opto-driver must be the same or higher than the rating of the power triac. In electrically noisy industrial locations, the dv/dt rating of the opto-driver and the triac must be considered.

The RMS current through the load and main terminals of the triac should be approximately 70% of the maximum rating of the device. However, a 40 A triac should not be chosen to control a 1 A load due to low latching and holding current requirements. Remember that the case temperature of the triac must be maintained at or below the current versus temperature curve specified on its data sheet. As with all semiconductors the lower the case temperature the better the reliability. Opto-driven gates normally do not use a sensitive gate triac. The opto-driver can supply up to 1 A gate pulses and less sensitive gate triacs have better dv/dt capability. If the load is resistive, it is acceptable to use a standard triac. However, if the load is a heavy inductive type, then an alternistor triac, or back-to-back SCRs as shown in Figure AN1007.9, is recommended. A series RC snubber network may or may not be necessary when using an alternistor triac. Normally a snubber network is not needed when using an alternistor because of its high dv/dt and dv/dt(c) capabilities. However, latching network as described in Figure AN1007.8 may be needed for low current load variations.

Zero Crossing Turn-on, Normally Open Relay Circuits

When a power circuit is mechanically switched on and off mechanically, generated high-frequency components are generated that can cause interference problems such as RFI. When power is initially applied, a step function of voltage is applied to the circuit which causes a shock excitation. Random switch opening stops current off, again generating high frequencies. In addition, abrupt current interruption in an inductive circuit can lead to high induced-voltage transients.

The latching characteristics of thyristors are ideal for eliminating interference problems due to current interruption since these devices can only turn off when the on-state current approaches zero, regardless of load power factor.

On the other hand, interference-free turn-on with thyristors requires special trigger circuits. It has been proven experimen-

tally that general purpose AC circuits will generate minimum electromagnetic interference (EMI) if energized at zero voltage.

The ideal AC circuit switch, therefore, consists of a contact which closes at the instant when voltage across it is zero and opens at the instant when current through it is zero. This has become known as “zero-voltage switching.”

For applications that require synchronized zero-crossing turn-on, the illustration in Figure AN1007.11 shows a circuit which incorporates an optocoupler with a built-in zero-crossing detector

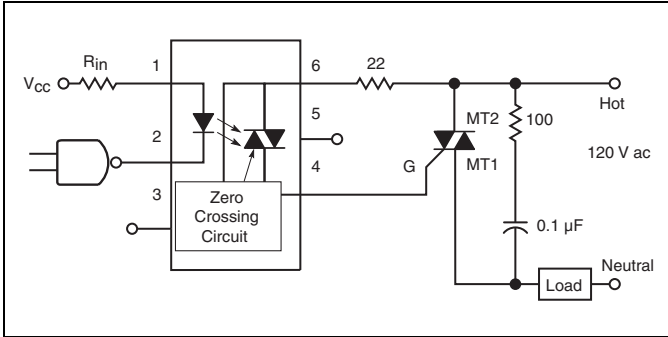

Figure AN1007.11 Optocoupled Circuit with Zero-crossing Turn-on (Triac or Alternistor)

Also, this circuit includes a dv/dt snubber network connected across the power triac. This typical circuit illustrates switching the hot line; however, the load may be connected to either the hot or neutral line. Also, note that the series gate resistor is low in value (22 Ω), which is possible on a 120 V line and above, since zero-crossing turn-on is ensured in any initial half cycle.

Summary of Zero Crossing Turn-on Circuits

Zero voltage crossing turn-on opto-drivers are designed to limit turn-on voltage to less than 20 V. This reduces the amount of RFI and EMI generated when the thyristor switches on. Because of this zero turn-on, these devices cannot be used to phase control loads. Therefore, speed control of a motor and dimming of a lamp cannot be accomplished with zero turn-on opto-couplers.

Since the voltage is limited to 20 V or less, the series gate resistor that limits the gate drive current has to be much lower with a zero crossing opto-driver. With typical inhibit voltage of 5 V, an alternistor triac gate could require a 160 mA at -30 °C (5 V / 0.16 A = 31 Ω gate resistor). If the load has a high inrush current, then drive the gate of the triac with as much current as reliably possible but stay under the I_{TSM} rating of the opto-driver. By using 22 Ω for the gate resistor, a current of at least 227 mA is supplied with only 5 V, but limited to 909 mA if the voltage goes to 20 V. As shown in Figure AN1007.12, Figure AN1007.13, and Figure AN1007.14, a 22 Ω gate resistor is a good choice for various zero crossing controllers.

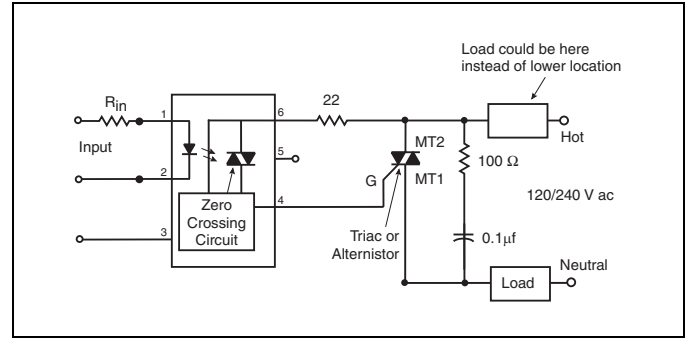

Figure AN1007.12 Zero Crossing Turn-on Opto Triac Driver

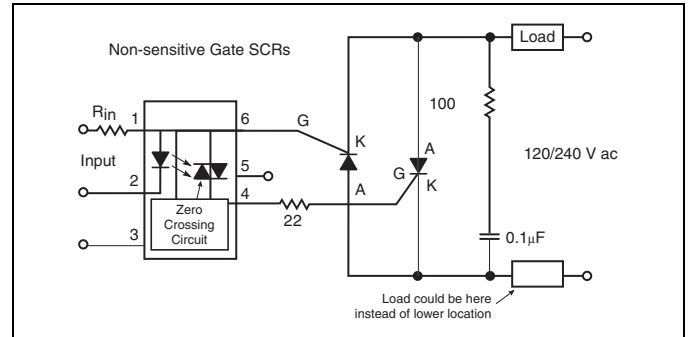

Figure AN1007.13 Zero Crossing Turn-on Non-sensitive SCR Driver

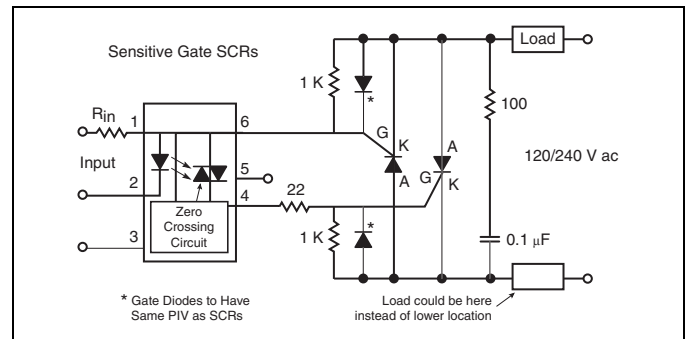

Figure AN1007.14 Zero Crossing Turn-on Opto-sensitive Gate SCR Driver

Time Delay Relay Circuit

By combining a 555 timer IC with a triac, various time delays of several seconds can be achieved for delayed activation of solid state relays or switches. Figure AN1007.15 shows a solid state timer delay relay using a sensitive gate triac and a 555 timer IC. The 555 timer precisely controls time delay of operation using an external resistor and capacitor, as illustrated by the resistor and capacitor combination curves. (Figure AN1007.16)

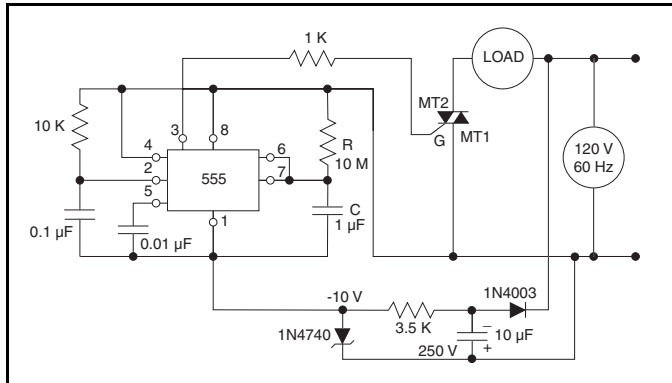

Figure AN1007.15 555 timer circuit with 10 second delay

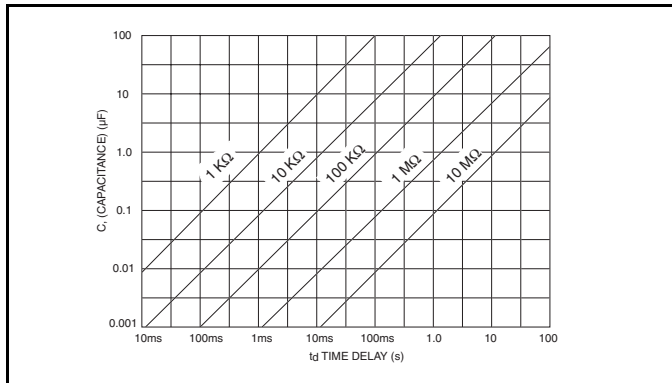

Figure AN1007.16 Resistor (R) and capacitor (C) combination curves

IR Motion Control

An example of a more complex triac switch is an infrared (IR) motion detector controller circuit. Some applications for this circuit are alarm systems, automatic lighting, and auto doorbells.

Figure AN1007.17 shows an easy-to-implement automatic lighting system using an infrared motion detector control circuit. A commercially available LSI circuit HT761XB, from *Holtek*, integrates most of the analog functions. This LSI chip, U2, contains the op amps, comparators, zero crossing detection, oscillators, and a triac output trigger. An external RC that is connected to the OSCD pin determines the output trigger pulse width. (*Holtek Semiconductor Inc.* is located at No.3, Creation Road II, Science-Based Industrial Park, Hsinchu, Taiwan, R.O.C.) Device U1 provides the infrared sensing. Device R13 is a photo sensor that serves to prevent inadvertent triggering under daylight or other high light conditions.

Choosing the right triac depends on the load characteristics. For example, an incandescent lamp operating at 110 V requires a 200 V, 8 A triac. This gives sufficient margin to allow for the high current state during lamp burn out. U2 provides a minimum output triac negative gate trigger current of 40 mA, thus operating in QII & QIII. This meets the requirements of a 25 mA gate triac. *Teccor* also offers alternistor triacs for inductive load conditions.

This circuit has three operating modes (ON, AUTO, OFF), which can be set through the mode pin. While the LSI chip is working in the auto mode, the user can override it and switch to the test mode, or manual on mode, or return to the auto mode by switching the power switch. More information on this circuit, such as mask options for the infrared trigger pulse and flash options, are available in the *Holtek* HT761X General Purpose PIR Controller specifications.

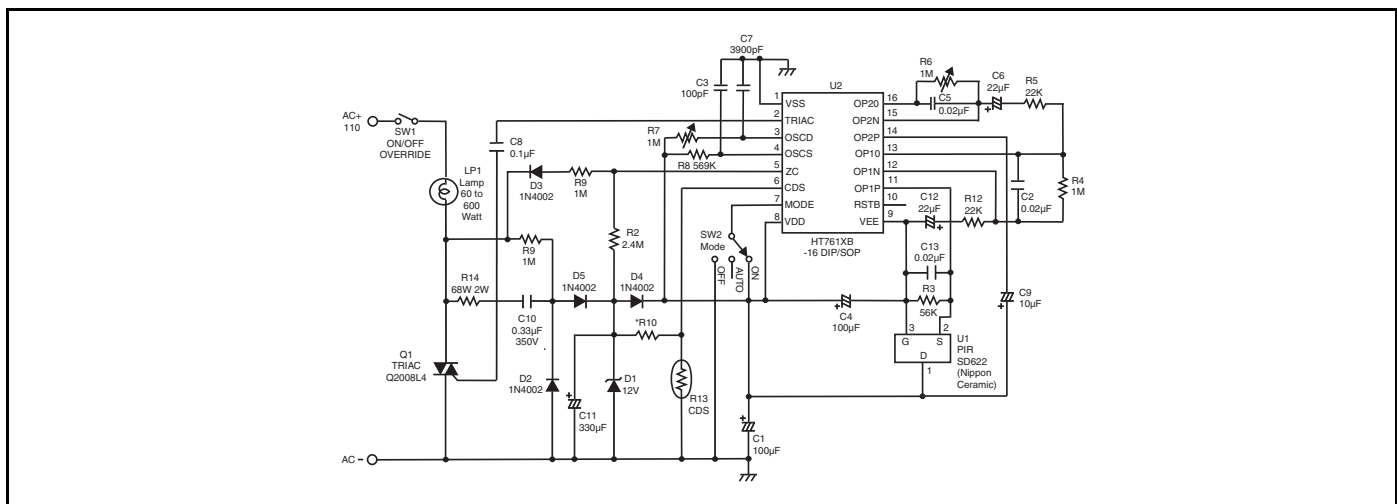

Figure AN1007.17 IR motion control circuit

Explanation of Maximum Ratings and Characteristics for Thyristors

Introduction

Data sheets for SCRs and triacs give vital information regarding maximum ratings and characteristics of thyristors. If the **maximum ratings** of the thyristors are surpassed, possible irreversible damage may occur. The **characteristics** describe various pertinent device parameters which are guaranteed as either minimums or maximums. Some of these characteristics relate to the ratings but are not ratings in themselves. The characteristic does not define what the circuit must provide or be restricted to, but defines the device characteristic. For example, a minimum value is indicated for the dv/dt because this value depicts the guaranteed worst-case limit for all devices of the specific type. This minimum dv/dt value represents the maximum limit that the circuit should allow.

Maximum Ratings

V_{RRM} : Peak Repetitive Reverse Voltage — SCR

The peak repetitive reverse voltage rating is the maximum peak reverse voltage that may be continuously applied to the main terminals (anode, cathode) of an SCR. (Figure AN1008.1) An open-gate condition and gate resistance termination is designated for this rating. An increased reverse leakage can result due to a positive gate bias during the reverse voltage exposure time of the SCR. The repetitive peak reverse voltage rating relates to case temperatures up to the maximum rated junction temperature.

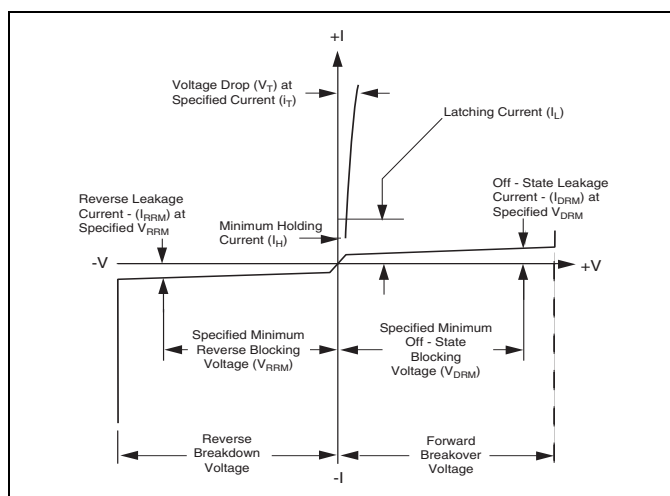

Figure AN1008.1 V-I Characteristics of SCR Device

V_{DRM} : Peak Repetitive Forward (Off-state) Voltage

SCR

The peak repetitive forward (off-state) voltage rating (Figure AN1008.1) refers to the maximum peak forward voltage which may be applied continuously to the main terminals (anode, cathode) of an SCR. This rating represents the maximum voltage the SCR should be required to block in the forward direction. The SCR may or may not go into conduction at voltages above the V_{DRM} rating. This rating is specified for an open-gate condition and gate resistance termination. A positive gate bias should be avoided since it will reduce the forward-voltage blocking capability. The peak repetitive forward (off-state) voltage rating applies for case temperatures up to the maximum rated junction temperature.

Triac

The peak repetitive off-state voltage rating should not be surpassed on a typical, non-transient, working basis. (Figure AN1008.2) V_{DRM} should not be exceeded even instantaneously. This rating applies for either positive or negative bias on main terminal 2 at the rated junction temperature. This voltage is less than the minimum breakover voltage so that breakover will not occur during operation. Leakage current is controlled at this voltage so that the temperature rise due to leakage power does not contribute significantly to the total temperature rise at rated current.

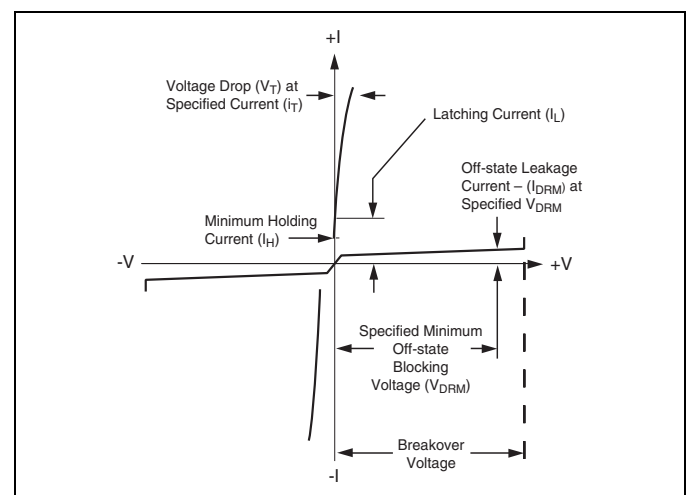

Figure AN1008.2 V-I Characteristics of Triac Device

I_T: Current Rating

SCR

For RMS and average currents, the restricting factor is usually confined so that the power dissipated during the on state and as a result of the junction-to-case thermal resistance will not produce a junction temperature in excess of the maximum junction temperature rating. Power dissipation is changed to RMS and average current ratings for a 60 Hz sine wave with a 180° conduction angle. The average current for conduction angles less than 180° is derated because of the higher RMS current connected with high peak currents. The DC current rating is higher than the average value for 180° conduction since no RMS component is present.

The dissipation for non-sinusoidal waveshapes can be determined in several ways. Graphically plotting instantaneous dissipation as a function of time is one method. The total maximum allowable power dissipation (P_D) may be determined using the following equation for temperature rise:

$$P_D = \frac{T_{J(MAX)} - T_C}{R_{\theta JC}}$$

where $T_{J(max)}$ is the maximum rated junction temperature (at zero rated current), T_C is the actual operating case temperature, and $R_{\theta JC}$ is the published junction-to-case thermal resistance. Transient thermal resistance curves are required for short interval pulses.

Triac

The limiting factor for RMS current is determined by multiplying power dissipation by thermal resistance. The resulting current value will ensure an operating junction temperature within maximum value. For convenience, dissipation is converted to RMS current at a 360° conduction angle. The same RMS current can be used at a conduction angle of less than 360°. For information on non-sinusoidal waveshapes and a discussion of dissipation, refer to the preceding description of SCR current rating.

I_{TSM}: Peak Surge (Non-repetitive) On-state Current — SCR and Triac

The peak surge current is the maximum peak current that may be applied to the device for one full cycle of conduction without device degradation. The maximum peak current is usually specified as sinusoidal at 50 Hz or 60 Hz. This rating applies when the device is conducting rated current before the surge and, thus, with the junction temperature at rated values before the surge. The junction temperature will surpass the rated operating temperature during the surge, and the blocking capacity may be decreased until the device reverts to thermal equilibrium.

The surge-current curve in Figure AN1008.3 illustrates the peak current that may be applied as a function of surge duration. This surge curve is not intended to depict an exponential current decay as a function of applied overload. Instead, the peak current shown for a given number of cycles is the maximum peak surge permitted for that time period. The current must be derated so that the peak junction temperature during the surge overload does not exceed maximum rated junction temperature if blocking is to be retained after a surge.

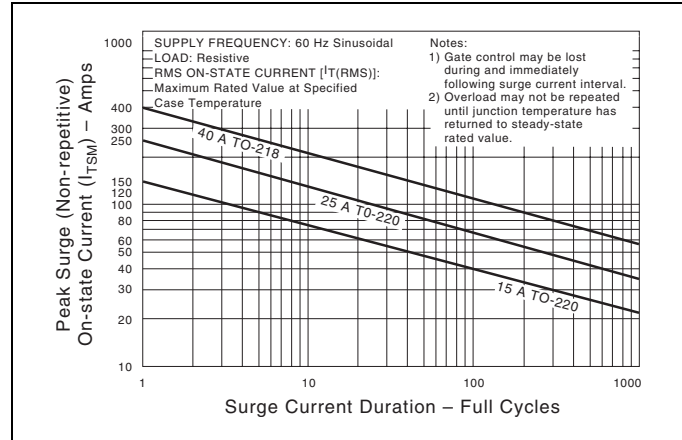

Figure AN1008.3 Peak Surge Current versus Surge Current Duration

I_{TM}: Peak Repetitive On-state Current — SCR and Triac

The I_{TM} rating specifies the maximum peak current that may be applied to the device during brief pulses. When the device operates under these circumstances, blocking capability is maintained. The minimum pulse duration and shape are defined and control the applied di/dt . The operating voltage, the duty factor, the case temperature, and the gate waveform are also defined. This rating must be followed when high repetitive peak currents are employed, such as in pulse modulators, capacitive-discharge circuits, and other applications where snubbers are required.

di/dt : Rate-of-change of On-state Current — SCR and Triac

The di/dt rating specifies the maximum rate-of-rise of current through a thyristor device during turn-on. The value of principal voltage prior to turn-on and the magnitude and rise time of the gate trigger waveform during turn-on are among the conditions under which the rating applies. If the rate-of-change of current (di/dt) exceeds this maximum value, or if turn-on with high di/dt during minimum gate drive occurs (such as dv/dt or overvoltage events), then localized heating may cause device degradation.

During the first few microseconds of initial turn-on, the effect of di/dt is more pronounced. The di/dt capability of the thyristor is greatly increased as soon as the total area of the pellet is in full conduction.

The di/dt effects that can occur as a result of voltage or transient turn-on (non-gated) is not related to this rating. The di/dt rating is specified for maximum junction temperature.

As shown in Figure AN1008.4, the di/dt of a surge current can be calculated by means of the following equation.

$$\frac{di}{dt} = \frac{\pi(I_{TM})}{t}$$

As an example, surge current of 400 A at 60 Hz has a di/dt of $\pi 400/8.3$ or 151.4 A/ms.

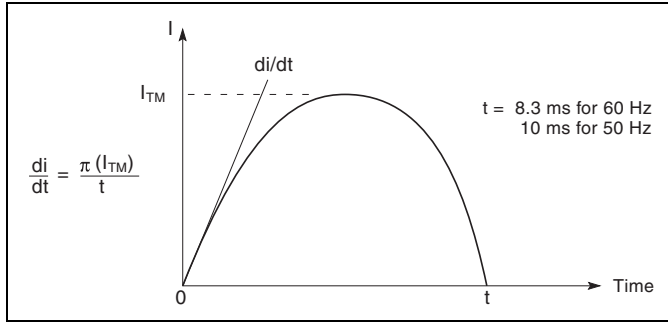

Figure AN1008.4 Relationship of Maximum Current Rating to Time

I^2t Rating — SCR and Triac

The I^2t rating gives an indication of the energy-absorbing capability of the thyristor device during surge-overload conditions. The rating is the product of the square of the RMS current (I_{RMS})² that flows through the device and the time during which the current is present and is expressed in A²s. This rating is given for fuse selection purposes. It is important that the I^2t rating of the fuse is less than that of the thyristor device. Without proper fuse or current limit, overload or surge current will permanently damage the device due to excessive junction heating.

P_G : Gate Power Dissipation — SCR and Triac

Gate power dissipation ratings define both the peak power (P_{GM}) forward or reverse and the average power ($P_{G(AV)}$) that may be applied to the gate. Damage to the gate can occur if these ratings are not observed. The width of the applied gate pulses must be considered in calculating the voltage and current allowed since the peak power allowed is a function of time. The peak power that results from a given signal source relies on the gate characteristics of the specific unit. The average power resulting from high peak powers must not exceed the average-power rating.

T_S, T_J : Temperature Range — SCR and Triac

The maximum storage temperature (T_S) is greater than the maximum operating temperature (actually maximum junction temperature). Maximum storage temperature is restricted by material limits defined not so much by the silicon but by peripheral materials such as solders used on the chip/die and lead attachments as well as the encapsulating epoxy. The forward and off-state blocking capability of the device determines the maximum junction (T_J) temperature. Maximum blocking voltage and leakage current ratings are established at elevated temperatures near maximum junction temperature; therefore, operation in excess of these limits may result in unreliable operation of the thyristor.

Characteristics

V_{BO} : Instantaneous Breakover Voltage — SCR and Triac

Breakover voltage is the voltage at which a device turns on (switches to on state by voltage breakover). (Figure AN1008.1) This value applies for open-gate or gate-resistance termination. Positive gate bias lowers the breakover voltage. Breakover is temperature sensitive and will occur at a higher voltage if the junction temperature is kept below maximum T_J value. If SCRs and triacs are turned on as a result of an excess of breakover voltage, instantaneous power dissipations may be produced that can damage the chip or die.

I_{DRM} : Peak Repetitive Off-state (Blocking) Current

SCR

I_{DRM} is the maximum leakage current permitted through the SCR when the device is forward biased with rated positive voltage on the anode (DC or instantaneous) at rated junction temperature and with the gate open or gate resistance termination. A 1000 Ω resistor connected between gate and cathode is required on all sensitive SCRs. Leakage current decreases with decreasing junction temperatures. Effects of the off-state leakage currents on the load and other circuitry must be considered for each circuit application. Leakage currents can usually be ignored in applications that control high power.

Triac

The description of peak off-state (blocking/leakage) current for the triac is the same as for the SCR except that it applies with either positive or negative bias on main terminal 2. (Figure AN1008.2)

I_{RRM} : Peak Repetitive Reverse Current — SCR

This characteristic is essentially the same as the peak forward off-state (blocking/leakage) current except negative voltage is applied to the anode (reverse biased).

V_{TM} : Peak On-State Voltage — SCR and Triac

The instantaneous on-state voltage (forward drop) is the principal voltage at a specified instantaneous current and case temperature when the thyristor is in the conducting state. To prevent heating of the junction, this characteristic is measured with a short current pulse. The current pulse should be at least 100 μ s duration to ensure the device is in full conduction. The forward-drop characteristic determines the on-state dissipation. See Figure AN1008.5, and refer to "IT: Current Rating" on page AN1008-2.

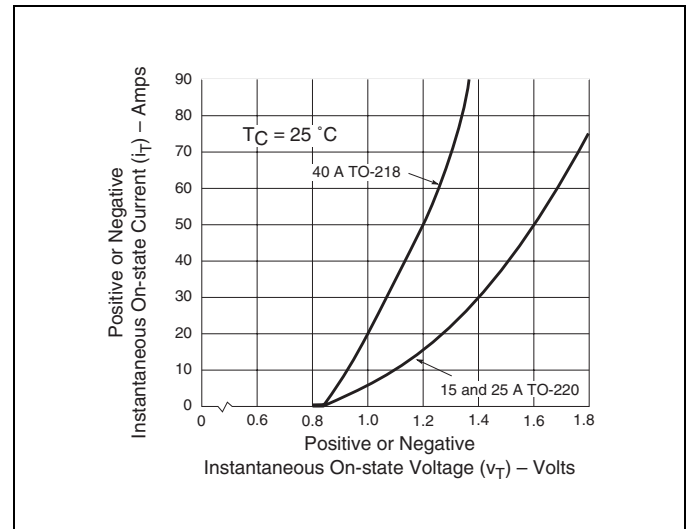

Figure AN1008.5 On-state Current versus On-state Voltage (Typical)

I_{GT} : DC Gate Trigger Current

SCR

I_{GT} is the minimum DC gate current required to cause the thyristor to switch from the non-conducting to the conducting state for a specified load voltage and current as well as case temperature. The characteristic curve illustrated in Figure AN1008.6 shows that trigger current is temperature dependent. The thyristor becomes less sensitive (requires more gate current) with decreasing junction temperatures. The gate current should be increased by a factor of two to five times the minimum threshold DC trigger current for best operation. Where fast turn-on is demanded and high di/dt is present or low temperatures are expected, the gate pulse may be 10 times the minimum I_{GT} , plus it must be fast-rising and of sufficient duration in order to properly turn on the thyristor.

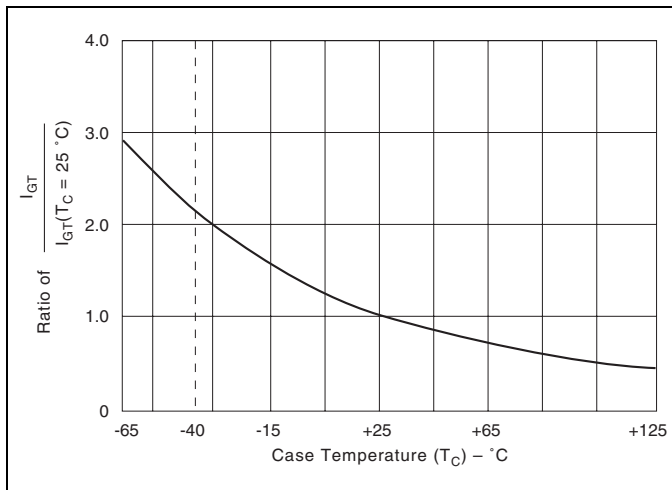

Figure AN1008.6 Normalized DC Gate Trigger Current for All Quadrants versus Case Temperature

Triac

The description for the SCR applies as well to the triac with the addition that the triac can be fired in four possible modes (Figure AN1008.7):

- Quadrant I (main terminal 2 positive, gate positive)
- Quadrant II (main terminal 2 positive, gate negative)
- Quadrant III (main terminal 2 negative, gate negative)
- Quadrant IV (main terminal 2 negative, gate positive)

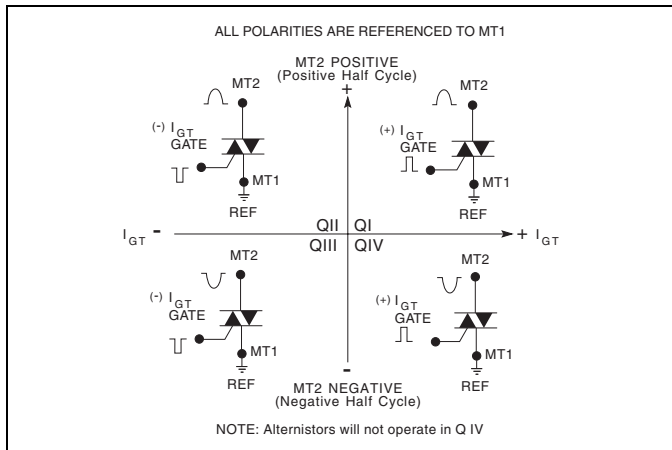

Figure AN1008.7 Definition of Operating Quadrants

V_{GT} : DC Gate Trigger Voltage

SCR

V_{GT} is the DC gate-cathode voltage that is present just prior to triggering when the gate current equals the DC trigger current. As shown in the characteristic curve in Figure AN1008.8, the gate trigger voltage is higher at lower temperatures. The gate-cathode voltage drop can be higher than the DC trigger level if the gate is driven by a current higher than the trigger current.

Triac

The difference in V_{GT} for the SCR and the triac is that the triac can be fired in four possible modes. The threshold trigger voltage can be slightly different, depending on which of the four operating modes is actually used.

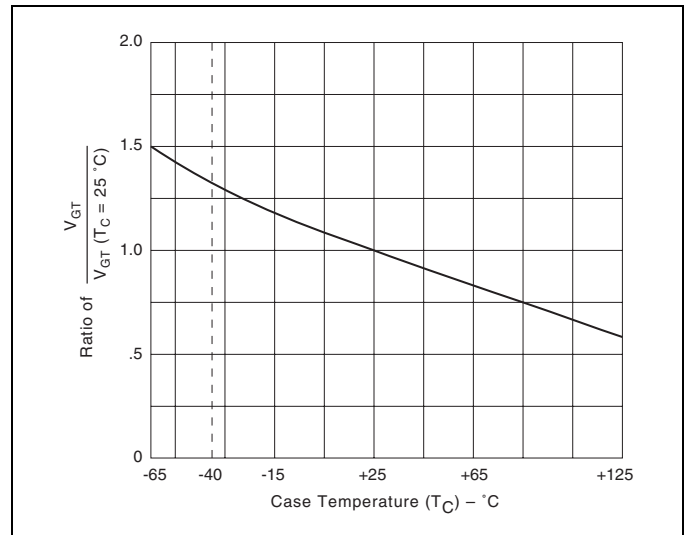

Figure AN1008.8 Normalized DC Gate Trigger Voltage for All Quadrants versus Case Temperature

I_L : Latching Current

SCR

Latching current is the DC anode current above which the gate signal can be withdrawn and the device stays on. It is related to, has the same temperature dependence as, and is somewhat greater than the DC gate trigger current. (Figure AN1008.1 and Figure AN1008.2) Latching current is at least equal to or much greater than the holding current, depending on the thyristor type.

Latching current is greater for fast-rise-time anode currents since not all of the chip/die is in conduction. It is this dynamic latching current that determines whether a device will stay on when the gate signal is replaced with very short gate pulses. The dynamic latching current varies with the magnitude of the gate drive current and pulse duration. In some circuits, the anode current may oscillate and drop back below the holding level or may even go negative; hence, the unit may turn off and not latch if the gate signal is removed too quickly.

Triac

The description of this characteristic for the triac is the same as for the SCR, with the addition that the triac can be latched on in four possible modes (quadrants). Also, the required latching is significantly different depending on which gating quadrants are used. Figure AN1008.9 illustrates typical latching current requirements for the four possible quadrants of operation.

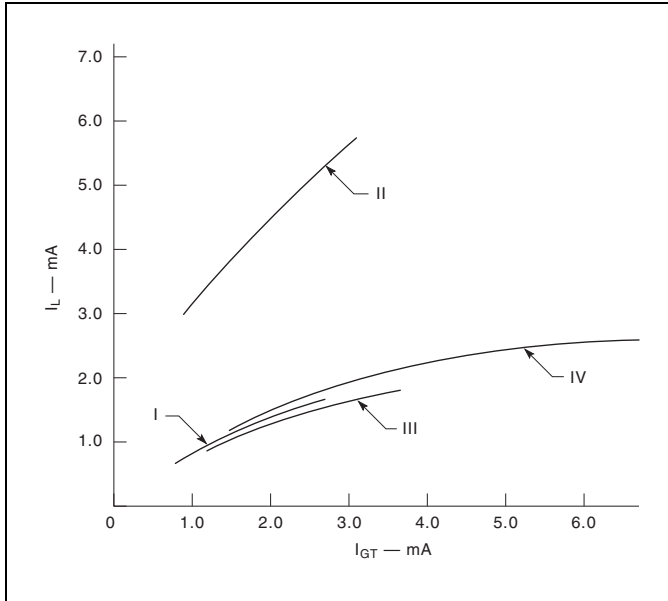

Figure AN1008.9 Typical Triac Latching (I_L) Requirements for Four Quadrants versus Gate Current (I_{GT})

I_H : Holding Current — SCR and Triac

The holding current is the DC principal on-state current below which the device will not stay in regeneration/on state after latching and gate signal is removed. This current is equal to or lower in value than the latching current (Figure AN1008.1 and Figure AN1008.2) and is related to and has the same temperature dependence as the DC gate trigger current shown in Figure AN1008.10. Both minimum and maximum holding current may be important. If the device is to stay in conduction at low-anode currents, the maximum holding current of a device for a given circuit must be considered. The minimum holding current of a device must be considered if the device is expected to turn off at a low DC anode current. Note that the low DC principal current condition is a DC turn-off mode, and that an initial on-state current (latching current) is required to ensure that the thyristor has been fully turned on prior to a holding current measurement.

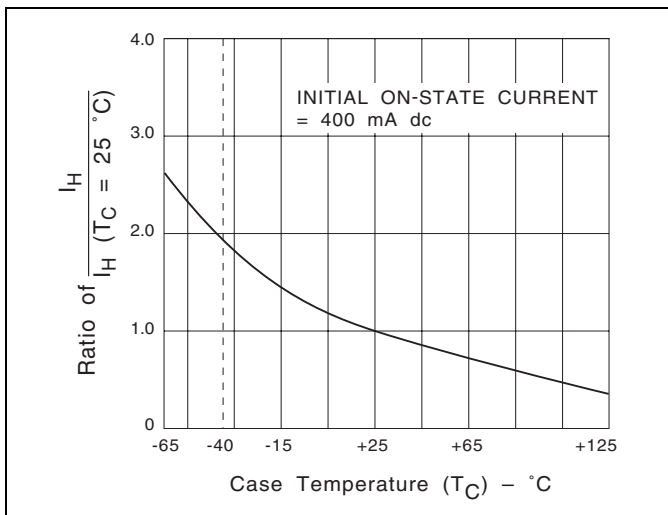

Figure AN1008.10 Normalized DC Holding Current versus Case Temperature

dv/dt, Static: Critical Rate-of-rise of Off-state Voltage — SCR and Triac

Static dv/dt is the minimum rate-of-rise of off-state voltage that a device will hold off, with gate open, without turning on. Figure AN1008.11 illustrates the exponential definition. This value will be reduced by a positive gate signal. This characteristic is temperature-dependent and is lowest at the maximum-rated junction temperature. Therefore, the characteristic is determined at rated junction temperature and at rated forward off-state voltage which is also a worst-case situation. Line or other transients which might be applied to the thyristor in the off state must be reduced, so that neither the rate-of-rise nor the peak voltage are above specifications if false firing is to be prevented. Turn-on as result of dv/dt is non-destructive as long as the follow current remains within current ratings of the device being used.

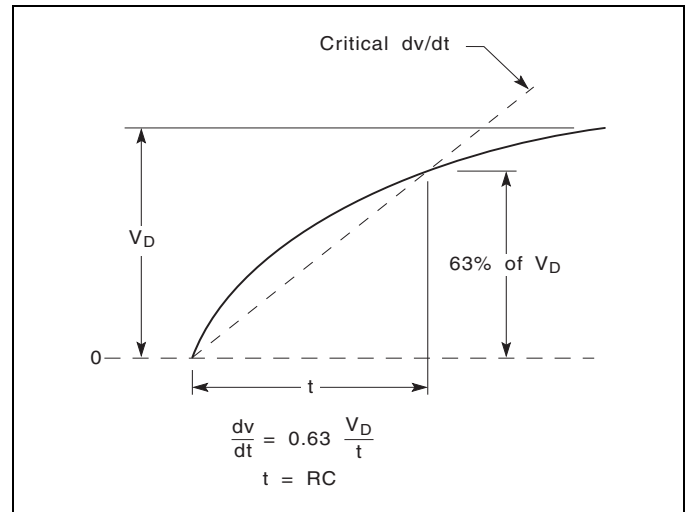

Figure AN1008.11 Exponential Rate-of-rise of Off-state Voltage Defining dv/dt

dv/dt, Commutating: Critical Rate-of-rise of Commutation Voltage — Triac

Commutating dv/dt is the rate-of-rise of voltage across the main terminals that a triac can support (block without switching back on) when commutating from the on state in one half cycle to the off state in the opposite half cycle. This parameter is specified at maximum rated case temperature (equal to T_J) since it is temperature-dependent. It is also dependent on current (commutating di/dt) and peak reapplied voltage (line voltage) and is specified at rated current and voltage. All devices are guaranteed to commute rated current with a resistive load at 50 Hz to 60 Hz. Commutation of rated current is not guaranteed at higher frequencies, and no direct relationship can be made with regard to current/temperature derating for higher-frequency operation. With inductive loading, when the voltage is out of phase with the load current, a voltage stress (dv/dt) occurs across the main terminals of the triac during the zero-current crossing. (Figure AN1008.12) A snubber (series RC across the triac) should be used with inductive loads to decrease the applied dv/dt to an amount below the minimum value which the triac can be guaranteed to commute off each half cycle.

Commutating dv/dt is specified for a half sinewave current at 60 Hz which fixes the di/dt of the commutating current. The commutating di/dt for 50 Hz is approximately 20% lower while I_{RMS} rating remains the same. (Figure AN1008.4)

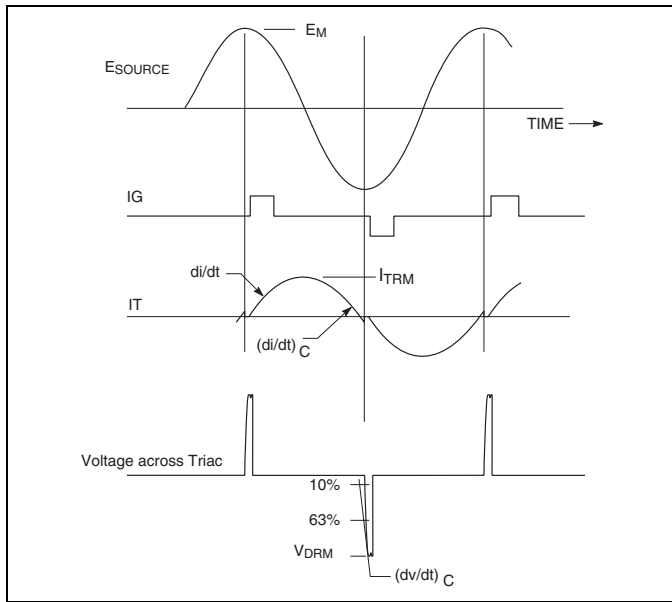

Figure AN1008.12 Waveshapes of Commutating dv/dt and Associated Conditions

t_{gt} : Gate-controlled Turn-on Time — SCR and Triac

The t_{gt} is the time interval between the application of a gate pulse and the on-state current reaching 90% of its steady-state value. (Figure AN1008.13) As would be expected, turn-on time is a function of gate drive. Shorter turn-on times occur for increased gate drives. This turn-on time is actually only valid for resistive loading. For example, inductive loading would restrict the rate-of-rise of anode current. For this reason, this parameter does not indicate the time that must be allowed for the device to stay on if the gate signal is removed. (Refer to the description of “IL: Latching Current” on page AN1008-4.) However, if the load was resistive and equal to the rated load current value, the device definitely would be operating at a current above the dynamic latching current in the turn-on time interval since current through the device is at 90% of its peak value during this interval.

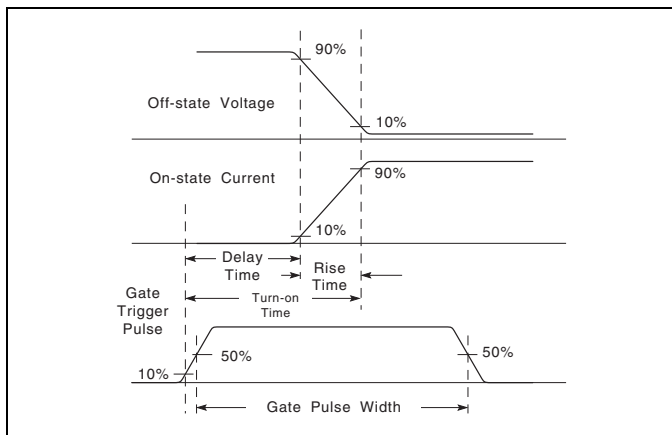

Figure AN1008.13 Waveshapes for Turn-on Time and Associated Conditions

t_q : Circuit-commutated Turn-off Time — SCR

The circuit-commutated turn-off time of the device is the time during which the circuit provides reverse bias to the device (negative anode) to commutate it off. The turn-off time occurs between the time when the anode current goes negative and when the anode positive voltage may be reapplied. (Figure AN1008.14) Turn-off time is a function of many parameters and very dependent on temperature and gate bias during the turn-off interval. Turn-off time is lengthened for higher temperature so a high junction temperature is specified. The gate is open during the turn-off interval. Positive bias on the gate will lengthen the turn-off time; negative bias on the gate will shorten it.

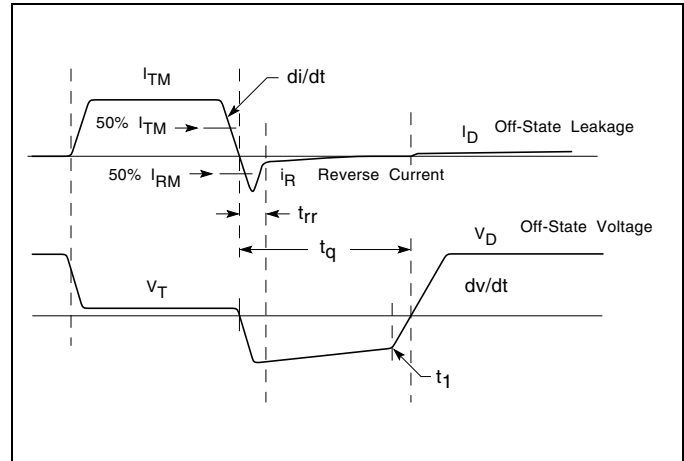

Figure AN1008.14 Waveshapes of t_q Rating Test and Associated Conditions

$R_{\theta JC}$, $R_{\theta JA}$: Thermal Resistance (Junction-to-case, Junction-to-ambient) — SCR and Triac

The thermal-resistance characteristic defines the steady-state temperature difference between two points at a given rate of heat-energy transfer (dissipation) between the points. The thermal-resistance system is an analog to an electrical circuit where thermal resistance is equivalent to electrical resistance, temperature difference is equivalent to voltage difference, and rate of heat-energy transfer (dissipation) is equivalent to current. Dissipation is represented by a constant current generator since generated heat must flow (steady-state) no matter what the resistance in its path. Junction-to-case thermal resistance establishes the maximum case temperature at maximum rated steady-state current. The case temperature must be held to the maximum at maximum ambient temperature when the device is operating at rated current. Junction-to-ambient thermal resistance is established at a lower steady-state current, where the device is in free air with only the external heat sinking offered by the device package itself. For $R_{\theta JA}$, power dissipation is limited by what the device package can dissipate in free air without any additional heat sink:

$$R_{\theta JC} = \frac{T_J - T_C}{P(AV)}$$

$$R_{\theta JA} = \frac{T_J - T_A}{P(AV)}$$

Miscellaneous Design Tips and Facts

Introduction

This application note presents design tips and facts on the following topics:

- Relationship of I_{AV} , I_{RMS} , and I_{PK}
- dv/dt Definitions
- Examples of gate terminations
- Curves for Average Current at Various Conduction Angles
- Double-exponential Impulse Waveform
- Failure Modes of Thyristor
- Characteristics Formulas for Phase Control Circuits

Relationship of I_{AV} , I_{RMS} , and I_{PK}

Since a single rectifier or SCR passes current in one direction only, it conducts for only half of each cycle of an AC sinewave. The average current (I_{AV}) then becomes half of the value determined for full-cycle conduction, and the RMS current (I_{RMS}) is equal to the square root of half the mean-square value for full-cycle conduction or half the peak current (I_{PK}). In terms of half-cycle sinewave conduction (as in a single-phase half-wave circuit), the relationships of the rectifier currents can be shown as follows:

$$I_{PK} = \pi I_{AV} = 3.14 I_{AV}$$

$$I_{AV} = (1/\pi) I_{PK} = 0.32 I_{PK}$$

$$I_{PK} = 2 I_{RMS}$$

$$I_{RMS} = 0.5 I_{PK}$$

$$I_{AV} = (2/\pi) I_{RMS} = 0.64 I_{RMS}$$

$$I_{RMS} = (\pi/2) I_{AV} = 1.57 I_{AV}$$

When two identically rated SCRs are connected inverse parallel for full-wave operation, as shown in Figure AN1009.1, they can handle 1.41 times the RMS current rating of either single SCR. Therefore, the RMS value of two half sinewave current pulses in one cycle is $\sqrt{2}$ times the RMS value of one such pulse per cycle.

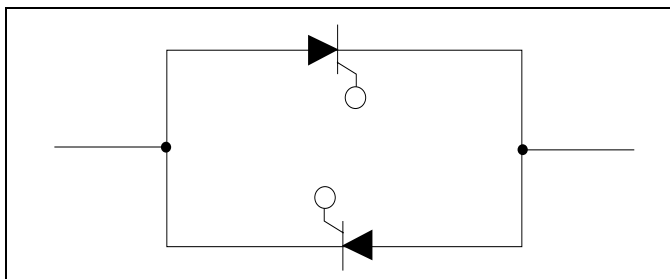

Figure AN1009.1 SCR Anti-parallel Circuit

dv/dt Definitions

The rate-of-rise of voltage (dv/dt) of an **exponential waveform** is 63% of peak voltage (excluding any overshoots) divided by the time at 63% minus 10% peak voltage. (Figure AN1009.2)

$$\text{Exponential dv/dt} = 0.63 \cdot [V_{PK}] = (t_2 - t_1)$$

$$\text{Resistor Capacitor circuit } t = RC = (t_2 - t_1)$$

$$\text{Resistor Capacitor circuit } 4 \cdot RC = (t_3 - t_2)$$

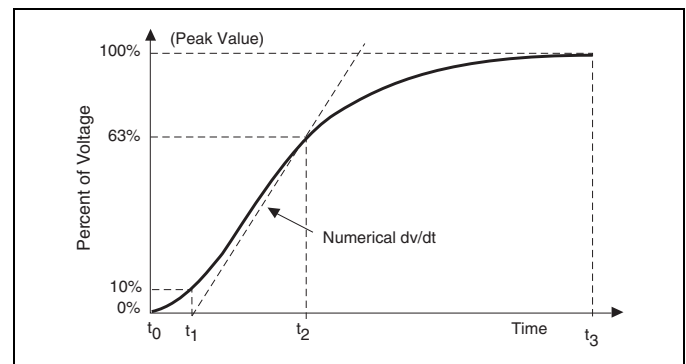

Figure AN1009.2 Exponential dv/dt Waveform

The rate-of-rise of voltage (dv/dt) of a **linear waveform** is 80% of peak voltage (excluding any overshoots) divided by the time at 90% minus 10% peak voltage. (Figure AN1009.3)

$$\text{Linear dv/dt} = 0.8 \cdot [V_{PK}] = (t_2 - t_1)$$

$$\text{Linear dv/dt} = [0.9 \cdot V_{PK} - 0.1 \cdot V_{PK}] = (t_2 - t_1)$$

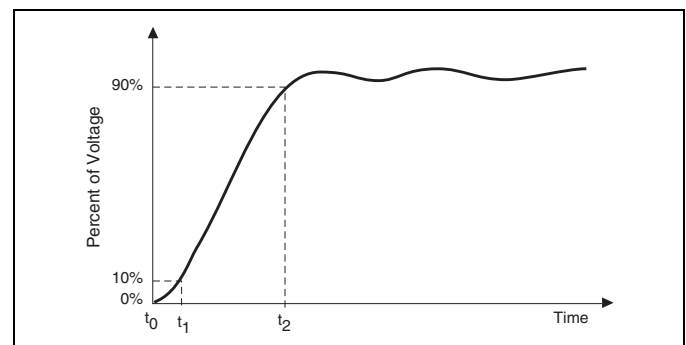
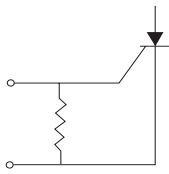
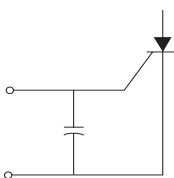

Figure AN1009.3 Linear dv/dt Waveform

Examples of Gate Terminations



Primary Purpose
 (1) Increase dv/dt capability
 (2) Keep gate clamped to ensure V_{DRM} capability
 (3) Lower t_q time
Related Effect — Raises the device latching and holding current



Primary Purpose
 (1) Increase dv/dt capability
 (2) Remove high frequency noise
Related Effects
 (1) Increases delay time
 (2) Increases turn-on interval
 (3) Lowers gate signal rise time
 (4) Lowers di/dt capability
 (5) Increases t_q time

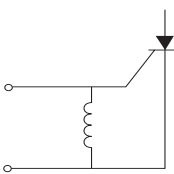

Primary Purpose
 (1) Decrease DC gate sensitivity
 (2) Decrease t_q time
Related Effects
 (1) Negative gate current increases holding current and causes gate area to drop out of conduction
 (2) In pulse gating gate signal tail may cause device to drop out of conduction

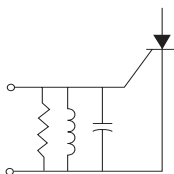

Primary Purpose — Select frequency
Related Effects — Unless circuit is "damped," positive and negative gate current may inhibit conduction or bring about sporadic anode current

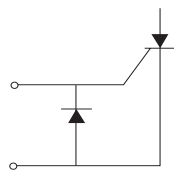

Primary Purpose
 (1) Supply reverse bias in off period
 (2) Protect gate and gate supply for reverse transients
 (3) Lower t_q time
Related Effects — Isolates the gate if high impedance signal source is used without sustained diode current in the negative cycle

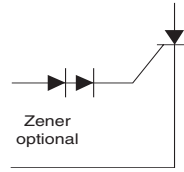

Primary Purpose — Decrease threshold sensitivity
Related Effects
 (1) Affects gate signal rise time and di/dt rating
 (2) Isolates the gate

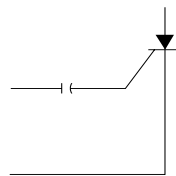

Primary Purpose — Isolate gate circuit DC component
Related Effects — In narrow gate pulses and low impedance sources, I_{gt} followed by reverse gate signals which may inhibit conduction

Curves for Average Current at Various Conduction Angles

SCR maximum average current curves for various conduction angles can be established using the factors for maximum average current at conduction angle of:

- 30° = 0.40 x Avg 180°
- 60° = 0.56 x Avg 180°
- 90° = 0.70 x Avg 180°
- 120° = 0.84 x Avg 180°

The reason for different ratings is that the average current for conduction angles less than 180° is derated because of the higher RMS current connected with high peak currents.

Note that maximum allowable case temperature (T_C) remains the same for each conduction angle curve but is established from average current rating at 180° conduction as given in the data sheet for any particular device type. The maximum T_C curve is then derated down to the maximum junction (T_J). The curves illustrated in Figure AN1009.4 are derated to 125 °C since the maximum T_J for the non-sensitive SCR series is 125 °C.

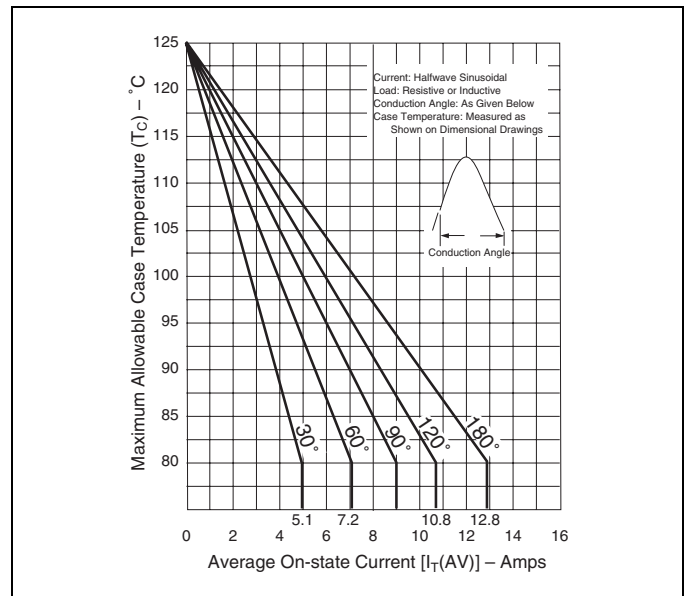

Figure AN1009.4 Typical Curves for Average On-state Current at Various Conduction Angles versus T_C for a SXX20L SCR

Double-exponential Impulse Waveform

A double-exponential impulse waveform or waveshape of current or voltage is designated by a combination of two numbers (t_r/t_d or $t_r \times t_d \mu s$). The first number is an exponential rise time (t_r) or wave front and the second number is an exponential decay time (t_d) or wave tail. The rise time (t_r) is the maximum rise time permitted. The decay time (t_d) is the minimum time permitted. Both the t_r and the t_d are in the same units of time, typically microseconds, designated at the end of the waveform description as defined by ANSI/IEEE C62.1-1989.

The rise time (t_r) of a current waveform is 1.25 times the time for the current to increase from 10% to 90% of peak value. See Figure AN1009.5.

$$t_r = \text{Rise Time} = 1.25 \cdot [t_c - t_a]$$

$$t_r = 1.25 \cdot [t(0.9 I_{PK}) - t(0.1 I_{PK})] = T_1 - T_0$$

The rise time (t_r) of a voltage waveform is 1.67 times the time for the voltage to increase from 30% to 90% of peak value. (Figure AN1009.5)

$$t_r = \text{Rise Time} = 1.67 \cdot [t_c - t_b]$$

$$t_r = 1.67 \cdot [t(0.9 V_{PK}) - t(0.3 V_{PK})] = T_1 - T_0$$

The decay time (t_d) of a waveform is the time from virtual zero (10% of peak for current or 30% of peak for voltage) to the time at which one-half (50%) of the peak value is reached on the wave tail. (Figure AN1009.5)

$$\text{Current Waveform } t_d = \text{Decay Time}$$

$$= [t(0.5 I_{PK}) - t(0.1 I_{PK})] = T_2 - T_0$$

$$\text{Voltage Waveform } t_d = \text{Decay Time}$$

$$= [t(0.5 V_{PK}) - t(0.3 V_{PK})] = T_2 - T_0$$

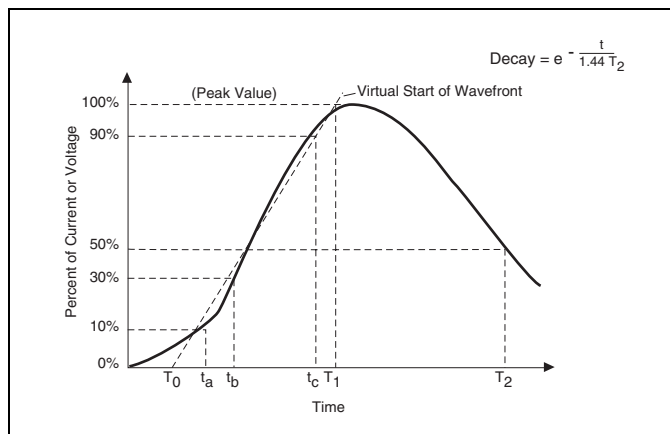

Figure AN1009.5 Double-exponential Impulse Waveform

Failure Modes of Thyristor

Thyristor failures may be broadly classified as either degrading or catastrophic. A degrading type of failure is defined as a change in some characteristic which may or may not cause a catastrophic failure, but could show up as a latent failure. Catastrophic failure is when a device exhibits a sudden change in characteristic that renders it inoperable. To minimize degrading and catastrophic failures, devices must be operated within maximum ratings at all times.

Degradation Failures

A significant change of on-state, gate, or switching characteristics is quite rare. The most vulnerable characteristic is blocking voltage. This type of degradation increases with rising operating voltage and temperature levels.

Catastrophic Failures

A catastrophic failure can occur whenever the thyristor is operated beyond its published ratings. The most common failure mode is an electrical short between the main terminals, although a triac can fail in a half-wave condition. It is possible, but not probable, that the resulting short-circuit current could melt the internal parts of the device which could result in an open circuit.

Failure Causes

Most thyristor failures occur due to exceeding the maximum operating ratings of the device. Overvoltage or overcurrent operations are the most probable cause for failure. Overvoltage failures may be due to excessive voltage transients or may also occur if inadequate cooling allows the operating temperature to rise above the maximum allowable junction temperature. Overcurrent failures are generally caused by improper fusing or circuit protection, surge current from load initiation, load abuse, or load failure. Another common cause of device failure is incorrect handling procedures used in the manufacturing process. Mechanical damage in the form of excessive mounting torque and/or force applied to the terminals or leads can transmit stresses to the internal thyristor chip and cause cracks in the chip which may not show up until the device is thermally cycled.

Prevention of Failures

Careful selection of the correct device for the application's operating parameters and environment will go a long way toward extending the operating life of the thyristor. Good design practice should also limit the maximum current through the main terminals to 75% of the device rating. Correct mounting and forming of the leads also help ensure against infant mortality and latent failures. The two best ways to ensure long life of a thyristor is by proper heat sink methods and correct voltage rating selection for worst case conditions. Overheating, overvoltage, and surge currents are the main killers of semiconductors.

Most Common Thyristor Failure Mode

When a thyristor is electrically or physically abused and fails either by degradation or a catastrophic means, it will short (full-wave or half-wave) as its normal failure mode. Rarely does it fail open circuit. The circuit designer should add line breaks, fuses, over-temperature interrupters or whatever is necessary to protect the end user and property if a shorted or partially shorted thyristor offers a safety hazard.

Characteristics Formulas for Phase Control Circuits

Circuit Name	Max Thyristor Voltage	PRV SCR	Max. Load Voltage $E_d = \text{Avg.}$ $E_a = \text{RMS}$	Load Voltage with Delayed Firing	Max. Average Thyristor or Rectifier Current	
					Avg. Amps	Cond. Period
Half-wave Resistive Load	$1.4 E_{RMS}$	E_P	$E_d = \frac{E_P}{\pi}$ $E_a = \frac{E_P}{2}$	$E_d = \frac{E_P}{2\pi}(1 + \cos \alpha)$ $E_a = \frac{E_P}{2\sqrt{\pi}}\sqrt{\pi - \alpha + \frac{1}{2}\sin 2\alpha}$	$\frac{E_P}{\pi R}$	180
Full-wave Bridge	$1.4 E_{RMS}$	E_P	$E_d = \frac{2E_P}{\pi}$	$E_d = \frac{E_P}{2\sqrt{\pi}}(1 + \cos \alpha)$	$\frac{E_P}{\pi R}$	180
Full-wave AC Switch Resistive Load	$1.4 E_{RMS}$	E_P	$E_a = \frac{E_P}{1.4}$	$E_a = \frac{E_P}{\sqrt{2\pi}}\sqrt{\pi - \alpha + \frac{1}{2}\sin 2\alpha}$	$\frac{E_P}{\pi R}$	180

NOTE: Angle alpha (α) is in radians.

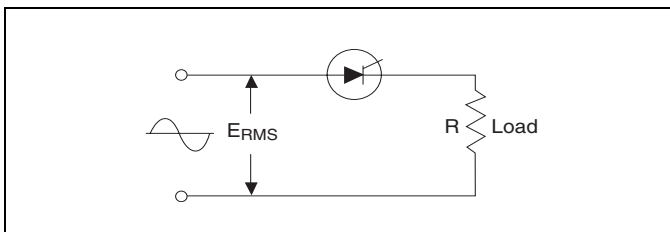

Half-wave Resistive Load – Schematic

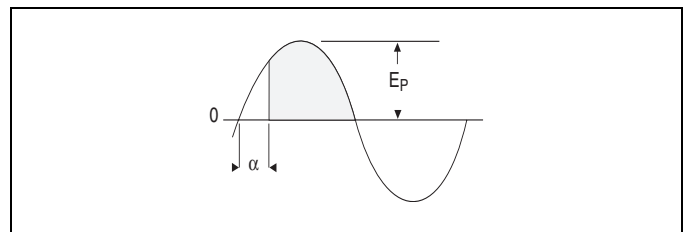

Half-wave Resistive Load – Waveform

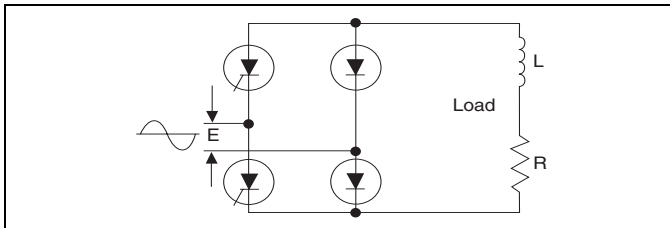

Full-wave Bridge – Schematic

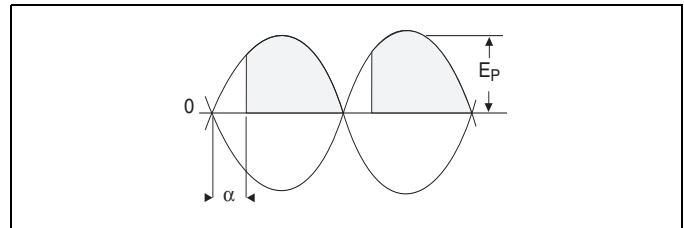

Full-wave Bridge – Waveform

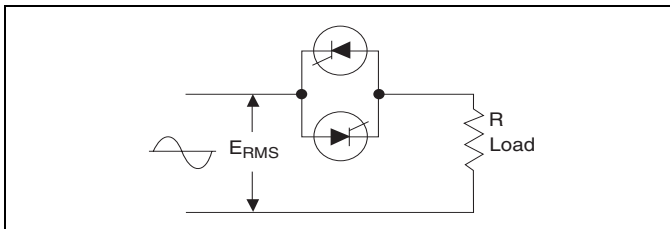

Full-wave AC Switch Resistive Load – Schematic

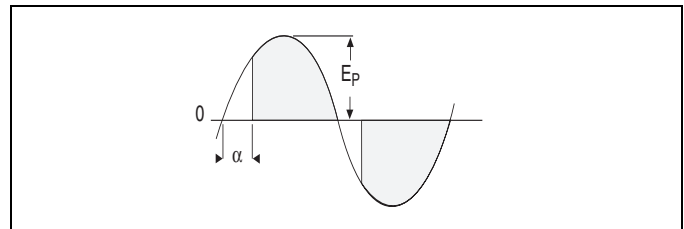

Full-wave AC Switch Resistive Load – Waveform

Thyristors for Ignition of Fluorescent Lamps

Introduction

One of the many applications for Teccor thyristors is in fluorescent lighting. Standard conventional and circular fluorescent lamps with filaments can be ignited easily and much more quickly by using thyristors instead of the mechanical starter switch, and solid state thyristors are more reliable. Thyristors produce a pure solid state igniting circuit with no mechanical parts in the fluorescent lamp fixture. Also, because the lamp ignites much faster, the life of the fluorescent lamp can be increased since the filaments are activated for less time during the ignition. The thyristor ignition eliminates any audible noise or flashing off and on which most mechanical starters possess.

Standard Fluorescent Circuit

The standard starter assembly is a glow switch mechanism with option small capacitor in parallel. (Figure AN1010.1)

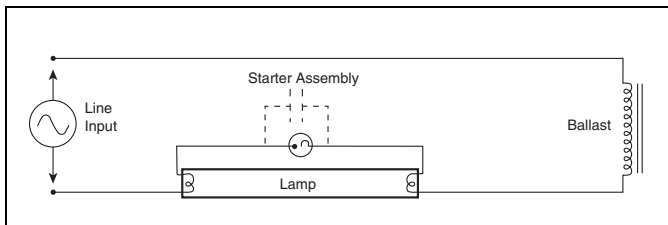

Figure AN1010.1 Typical Standard Fluorescent Circuit

The glow switch is made in a small glass bulb containing neon or argon gas. Inside the bulb is a U-shaped bimetallic strip and a fixed post. When the line input current is applied, the voltage between the bimetallic strip and the fixed post is high enough to ionize and produce a glow similar to a standard neon lamp. The heat from the ionization causes the bimetallic strip to move and make contact to the fixed post. At this time the ionization ceases and current can flow through and pre-heat the filaments of the fluorescent lamp.

Since ionization (glowing) has ceased, the bimetallic strip begins to cool down and in a few seconds opens to start ionization (glowing) again. The instant the bimetallic ceases to make contact (opens), an inductive kick from the ballast produces some high voltage spikes 400 V to 600 V, which can ignite (strike) the fluorescent lamp. If the lamp fails to ignite or start, the glow switch mechanically repeats its igniting cycle over and over until the lamp ignites, usually within a few seconds.

In this concept the ballast (inductor) is able to produce high voltage spikes using a mechanical switch opening and closing, which is fairly slow.

Since thyristors (solid state switches) do not mechanically open and close, the conventional fluorescent lighting circuit concept must be changed in order to use thyristors. In order to ignite (strike) a fluorescent lamp, a high voltage spike must be produced. The spike needs to be several hundred volts to quickly initiate ionization in the fluorescent lamp. A series ballast can only produce high voltage if a mechanical switch is used in conjunction with it. Therefore, with a thyristor a standard series ballast (inductor) is only useful as a current limiter.

Methods for Producing High Voltage

The circuits illustrated in Figure AN1010.2 through Figure AN1010.5 show various methods for producing high voltage to ignite fluorescent lamps using thyristors (solid state switches).

Note: Due to many considerations in designing a fluorescent fixture, the illustrated circuits are not necessarily the optimum design.

One 120 V ac circuit consists of triac and diac thyristors with a capacitor to ignite the fluorescent lamp. (Figure AN1010.2)

This circuit allows the 5 μF ac capacitor to be charged and added to the peak line voltage, developing close to 300 V peak or 600 V peak to peak. This is accomplished by using a triac and diac phase control network set to fire near the 90° point of the input line. A capacitor-charging network is added to ensure that the capacitor is charged immediately, letting tolerances of components or temperature changes in the triac and diac circuit to be less critical. By setting the triac and diac phase control to fire at near the 90° point of the sinewave, maximum line voltages appear across the lamp for ignition. As the triac turns on during each half cycle, the filaments are pre-heated and in less than a second the lamp is lit. Once the lamp is lit the voltage is clamped to approximately 60 V peak across the 15 W to 20 W lamp, and the triac and diac circuit no longer functions until the lamp is required to be ignited again.

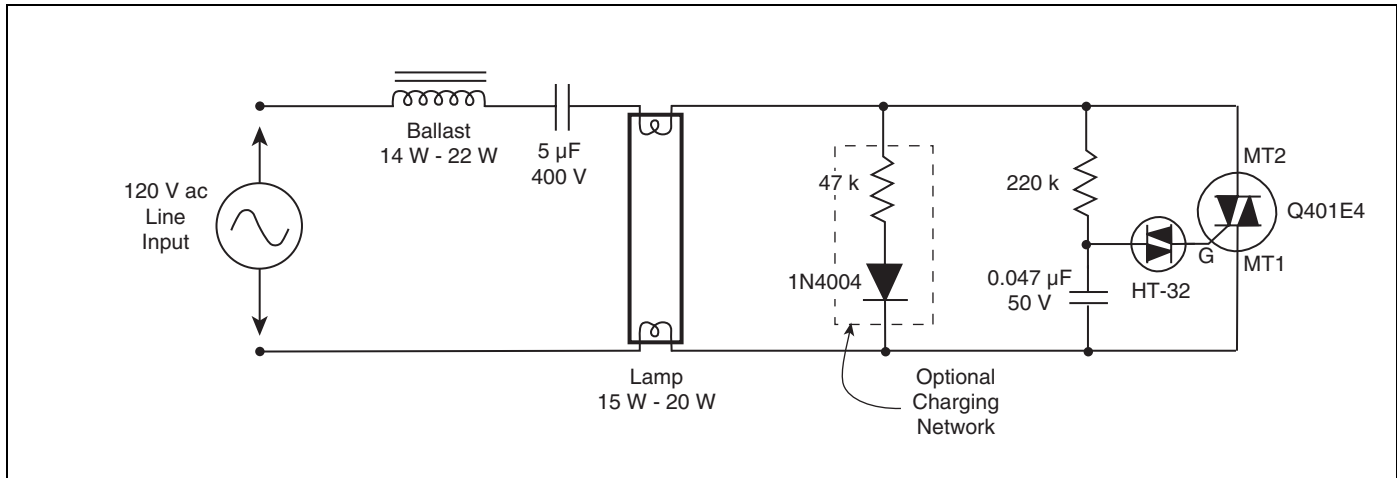

Figure AN1010.2 120 V ac Triac/Diac Circuit

Figure AN1010.3 illustrates a circuit using a sidac (a simpler thyristor) phase control network to ignite a 120 V ac fluorescent lamp. As in the triac/diac circuit, the 5 μF ac capacitor is charged and added to the peak line voltage, developing greater than 200 V peak or 400 V peak to peak. Since the sidac is a voltage breakover (V_{BO}) activated device with no gate, a charging network is essential in this circuit to charge the capacitor above the

peak of the line in order to break over (turn on) the sidac with a V_{BO} of 220 V to 250 V.

As the sidac turns on each half cycle, the filaments are pre-heated and in less than 1.5 seconds the lamp is lit. Once the lamp is lit, the voltage across it clamps to approximately 60 V peak (for a 15 W to 20 W lamp), and the sidac ceases to function until the lamp is required to be ignited again.

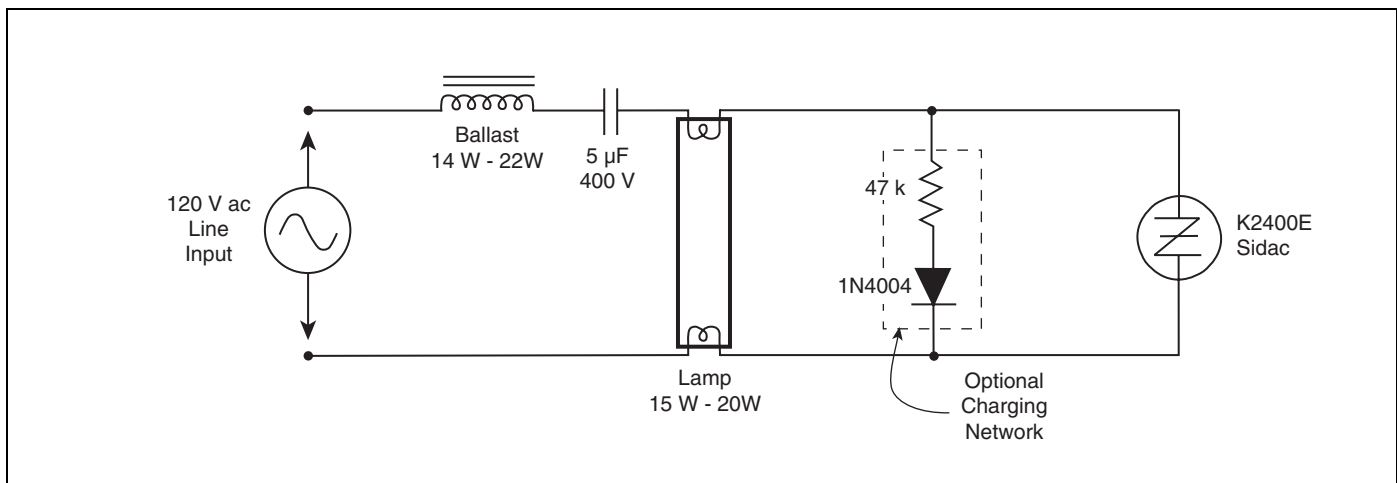

Figure AN1010.3 120 V ac Sidac Circuit

The circuits illustrated in Figure AN1010.2 and Figure AN1010.3 use 15 W to 20 W lamps. The same basic circuits can be applied to higher wattage lamps. However, with higher wattage lamps the voltage developed to fire (light) the lamp will need to be somewhat higher. For instance, a 40 W lamp is critical on line input voltage to ignite, and after it is lit the voltage across the lamp will clamp to approximately 130 V peak. For a given type of lamp, the current must be limited to constant current regardless of the wattage of the lamp.

Figure AN1010.4 shows a circuit for igniting a fluorescent lamp with 240 V line voltage input using triac and diac networks.

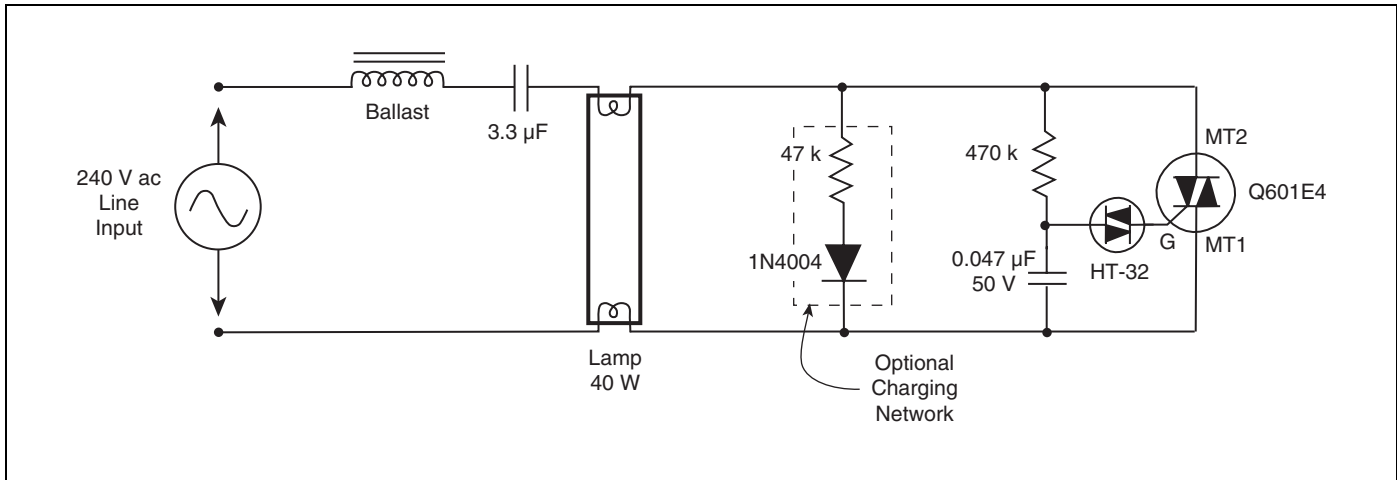

Figure AN1010.4 240 V ac Triac/Diac Circuit

Figure AN1010.5 illustrates a circuit using a sidac phase control network to ignite a 240 V ac fluorescent lamp. This circuit works basically the same as the 120 V circuit shown in Figure AN1010.3, except that component values are changed to com-

pensate for higher voltage. The one major change is that two K2400E devices in series are used to accomplish high firing voltage for a fluorescent lamp.

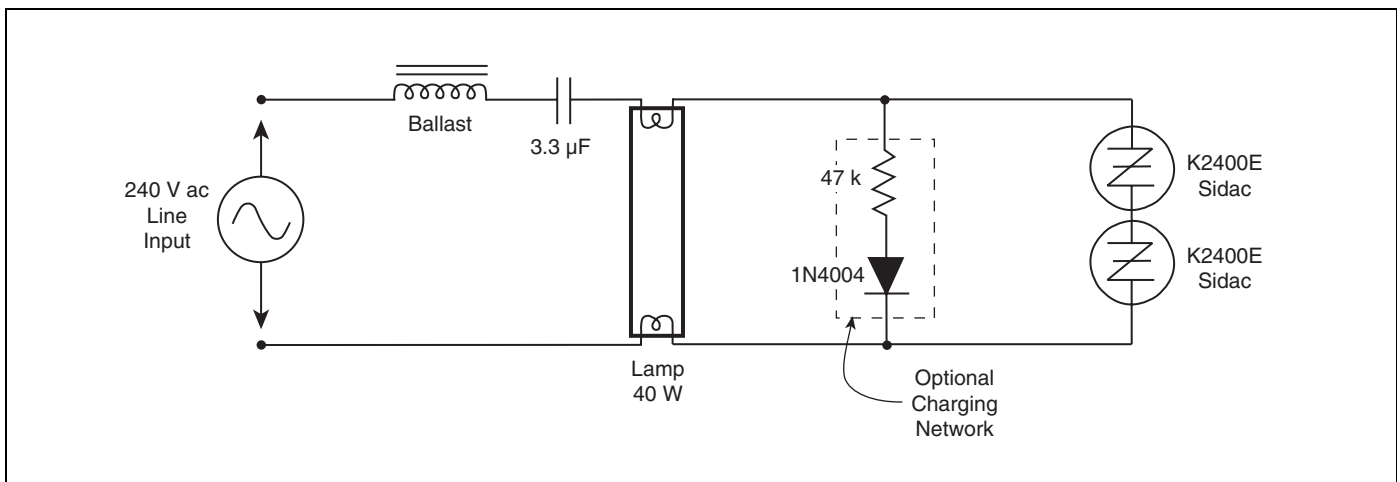

Figure AN1010.5 240 V ac Sidac Circuit

Notes

Cross Reference Guide

Triacs, SCRs, Diacs, Sidacs, and Rectifiers (Suggested Teccor Replacements for JEDEC and Industry House Numbers)

How To Use This Guide

This Cross Reference Guide will help you determine the competitive products that Teccor supplies on either a DIRECT REPLACEMENT or SUGGESTED REPLACEMENT basis.

Teccor offers replacements for most competitive devices. If you do not find a desired competitive product type listed, please contact the factory for information on recent additions to this list.

On the following pages, listed in alphanumeric order, you will find:

- Competitive product number
- Teccor device part number
- “D” indicating the Direct replacement (Teccor device meets or exceeds the electrical and mechanical specifications of the competitive device); “S” indicates a Suggested replacement (The suggested replacements in this guide represent the nearest Teccor equivalent for the product listed and in most instances are replacements. However, Teccor assumes no responsibility and does not guarantee that the replacements

are exact; only that the replacements will meet the terms of its applicable published written specifications. The pertinent Teccor specification sheet should be used as the principle tool for actual replacements.)

- Teccor package type

For additional assistance, contact your nearest Teccor distributor, sales representative, or the factory.

Part Number	Teccor Device	Direct or Suggested Replacement	Teccor Package
40431	Q2006LT	S	TO-220 (ISOL)
03P05M	EC103B	S	TO-92 (ISOL)
03P1M	EC103B	S	TO-92 (ISOL)
03P2M	EC103B	S	TO-92 (ISOL)
03P3M	EC103D	S	TO-92 (ISOL)
03P4M	EC103D	S	TO-92 (ISOL)
03P5M	EC103M	S	TO-92 (ISOL)
10TTS08S	S8012D	S	TO-252 (SMDT)
16TTS08	S8016R	D	TO-220 (N.ISOL)
16TTS08S	S8016N	S	TO-263 (SMT)
25TTS08	S8025R	D	TO-220 (N.ISOL)
25TTS08FP	S8025L	D	TO-220 (ISOL)
25TTS08S	S8025N	S	TO-263 (SMT)
2N1595	S201E	S	TO-92 (ISOL)
2N1596	S201E	S	TO-92 (ISOL)
2N1597	S201E	S	TO-92 (ISOL)
2N1598	S401E	S	TO-92 (ISOL)
2N1599	S401E	S	TO-92 (ISOL)
2N2323	TCR22-4 75	S	TO-92 (ISOL)
2N3001	EC103B	S	TO-92 (ISOL)
2N3002	EC103B	S	TO-92 (ISOL)
2N3003	EC103B	S	TO-92 (ISOL)
2N3004	EC103B	S	TO-92 (ISOL)
2N3005	EC103B	D	TO-92 (ISOL)
2N3006	EC103B	D	TO-92 (ISOL)
2N3007	EC103B	D	TO-92 (ISOL)
2N3008	EC103B	D	TO-92 (ISOL)
2N3228	S2006R	S	TO-220 (N.ISOL)
2N3525	S4006R	S	TO-220 (N.ISOL)
2N3528	S2006F1	S	TO-202 (N.ISOL)
2N3529	S4006F1	S	TO-202 (N.ISOL)
2N4101	S6006L	S	TO-220 (ISOL)
2N4102	S6006F1	S	TO-202 (N.ISOL)
2N4441	S2008R	S	TO-220 (N.ISOL)
2N4442	S2008R	S	TO-220 (N.ISOL)
2N4443	S4008R	S	TO-220 (N.ISOL)
2N4444	S6008R	S	TO-220 (N.ISOL)
2N5060	2N5064	D	TO-92 (ISOL)
2N5061	2N5064	D	TO-92 (ISOL)
2N5062	2N5064	D	TO-92 (ISOL)
2N5063	2N5064	D	TO-92 (ISOL)
2N5064	2N5064	D	TO-92 (ISOL)
2N5754	Q2004F41	S	TO-202 (N.ISOL)
2N5755	Q2004F41	S	TO-202 (N.ISOL)
2N5756	Q4004F41	S	TO-202 (N.ISOL)
2N6068	Q2004F41	S	TO-202 (N.ISOL)
2N6068A	L2004F51	S	TO-202 (N.ISOL)
2N6068B	L2004F31	S	TO-202 (N.ISOL)
2N6069	Q2004F41	S	TO-202 (N.ISOL)
2N6069A	L2004F51	S	TO-202 (N.ISOL)
2N6069B	L2004F31	S	TO-202 (N.ISOL)
2N6070	Q2004F41	S	TO-202 (N.ISOL)
2N6070A	L2004F51	S	TO-202 (N.ISOL)
2N6070B	L2004F31	S	TO-202 (N.ISOL)
2N6071	Q2004F41	S	TO-202 (N.ISOL)
2N6071A	L2004F51	S	TO-202 (N.ISOL)
2N6071B	L2004F31	S	TO-202 (N.ISOL)
2N6072	Q4004F41	S	TO-202 (N.ISOL)
2N6072A	L4004F51	S	TO-202 (N.ISOL)
2N6072B	L4004F31	S	TO-202 (N.ISOL)
2N6073	Q4004F41	S	TO-202 (N.ISOL)
2N6073A	L4004F51	S	TO-202 (N.ISOL)
2N6073B	L4004F31	S	TO-202 (N.ISOL)
2N6074	Q6004F41	S	TO-202 (N.ISOL)
2N6074A	L6004F51	S	TO-202 (N.ISOL)
2N6074B	L6004F31	S	TO-202 (N.ISOL)
2N6075	Q6004F41	S	TO-202 (N.ISOL)
2N6075A	L6004F51	S	TO-202 (N.ISOL)
2N6075B	L6004F31	S	TO-202 (N.ISOL)
2N6236	T106B1	S	TO-202 (N.ISOL)

Part Number	Teccor Device	Direct or Suggested Replacement	Teccor Package
2N6237	T106B1	S	TO-202 (N.ISOL)
2N6238	T106B1	S	TO-202 (N.ISOL)
2N6239	T106B1	S	TO-202 (N.ISOL)
2N6240	T106D1	S	TO-202 (N.ISOL)
2N6241	T106M1	S	TO-202 (N.ISOL)
2N6342	Q2008R4	S	TO-220 (N.ISOL)
2N6342A	Q2012RH5	S	TO-220 (N.ISOL)
2N6343	Q4008R4	S	TO-220 (N.ISOL)
2N6343A	Q4012RH5	S	TO-220 (N.ISOL)
2N6344	Q6008R5	S	TO-220 (N.ISOL)
2N6344A	Q6012RH5	S	TO-220 (N.ISOL)
2N6345	Q8008R5	S	TO-220 (N.ISOL)
2N6345A	Q8012RH5	S	TO-220 (N.ISOL)
2N6346A	Q2015R5	S	TO-220 (N.ISOL)
2N6347A	Q4015R5	S	TO-220 (N.ISOL)
2N6348A	Q6015R5	S	TO-220 (N.ISOL)
2N6349	Q8010R5	S	TO-220 (N.ISOL)
2N6349A	Q8015R5	S	TO-220 (N.ISOL)
2N6394	S2012R	D	TO-220 (N.ISOL)
2N6395	S2012R	D	TO-220 (N.ISOL)
2N6396	S2012R	D	TO-220 (N.ISOL)
2N6397	S4012R	D	TO-220 (N.ISOL)
2N6398	S6012R	D	TO-220 (N.ISOL)
2N6399	S8012R	D	TO-220 (N.ISOL)
2N6400	S2016R	D	TO-220 (N.ISOL)
2N6401	S2016R	D	TO-220 (N.ISOL)
2N6402	S2016R	D	TO-220 (N.ISOL)
2N6403	S4016R	D	TO-220 (N.ISOL)
2N6404	S6016R	D	TO-220 (N.ISOL)
2N6405	S8016R	D	TO-220 (N.ISOL)
2N6504	S2025R	D	TO-220 (N.ISOL)
2N6505	S2025R	D	TO-220 (N.ISOL)
2N6506	S2025R	D	TO-220 (N.ISOL)
2N6507	S4025R	D	TO-220 (N.ISOL)
2N6508	S6025R	D	TO-220 (N.ISOL)
2N6509	S8025R	D	TO-220 (N.ISOL)
2N6564	2N6565	D	TO-92 (ISOL)
2N6564	EC103D	S	TO-92 (ISOL)
2N6565	2N6565	D	TO-92 (ISOL)
2N6565	EC103D	S	TO-92 (ISOL)
2N877	EC103B	S	TO-92 (ISOL)
2N878	EC103B	S	TO-92 (ISOL)
2N879	EC103B	S	TO-92 (ISOL)
2N880	EC103B	S	TO-92 (ISOL)
2N881	EC103B	S	TO-92 (ISOL)
2N885	2N5064	D	TO-92 (ISOL)
2N886	2N5064	D	TO-92 (ISOL)
2N887	2N5064	D	TO-92 (ISOL)
2N888	2N5064	D	TO-92 (ISOL)
2N889	2N5064	D	TO-92 (ISOL)
2P05M	T106B1	S	TO-202 (N.ISOL)
2P1M	T106B1	S	TO-202 (N.ISOL)
2P2M	T106B1	S	TO-202 (N.ISOL)
2P4M	T106D1	S	TO-202 (N.ISOL)
2P5M	T106M1	S	TO-202 (N.ISOL)
2P6M	T106M1	S	TO-202 (N.ISOL)
30TPS08	S8035K	S	TO-218AC (ISOL) "K"
3P4J	T106D2	S	TO-202 (N.ISOL)
40TPS08	S8035K	S	TO-218AC (ISOL) "K"
5P05M	S2008R	S	TO-220 (N.ISOL)
5P1M	S2008R	S	TO-220 (N.ISOL)
5P2M	S2008R	S	TO-220 (N.ISOL)
5P4M	S4008R	S	TO-220 (N.ISOL)
5P5M	S6008R	S	TO-220 (N.ISOL)
5P6M	S6008R	S	TO-220 (N.ISOL)
8T04HA	Q2004F41	D	TO-202 (N.ISOL)
8T04SH	L2004F81	S	TO-202 (N.ISOL)
8T14HA	Q2004F41	D	TO-202 (N.ISOL)
8T14SH	L2004F81	S	TO-202 (N.ISOL)
8T24HA	Q2004F41	D	TO-202 (N.ISOL)

Part Number	Teccor Device	Direct or Suggested Replacement	Teccor Package
8T24SH	L2004F81	S	TO-202 (N.ISOL)
8T34HA	Q4004F41	D	TO-202 (N.ISOL)
8T34SH	L4004F81	S	TO-202 (N.ISOL)
8T44HA	Q4004F41	D	TO-202 (N.ISOL)
8T44SH	L4004F81	S	TO-202 (N.ISOL)
8T54HA	Q6004F41	D	TO-202 (N.ISOL)
8T64HA	Q6004F41	D	TO-202 (N.ISOL)
8T64SH	L6004F81	S	TO-202 (N.ISOL)
AC03BGM	Q2004F41	S	TO-202 (N.ISOL)
AC03DGM	Q4004F41	S	TO-202 (N.ISOL)
AC03EGM	Q5004F41	S	TO-202 (N.ISOL)
AC03FGM	Q6004F41	S	TO-202 (N.ISOL)
AC08BGM	Q2008R5	S	TO-220 (N.ISOL)
AC08BSM	Q2008LH4	S	TO-220 (N.ISOL)
AC08DGM	Q4008R4	S	TO-220 (N.ISOL)
AC08DSM	Q4008LH4	S	TO-220 (ISOL)
AC08EGM	Q6008R4	S	TO-220 (N.ISOL)
AC08ESM	Q6008LH4	S	TO-220 (ISOL)
AC08FGM	Q6008R5	S	TO-220 (N.ISOL)
AC08FSM	Q6008LH4	S	TO-220 (ISOL)
AC10BGML	Q2010RH5	S	TO-220 (N.ISOL)
AC10BSM	Q2010LH5	S	TO-220 (ISOL)
AC10DGML	Q4010RH5	S	TO-220 (N.ISOL)
AC10DSM	Q4010LH5	S	TO-220 (ISOL)
AC10EGML	Q6010RH5	S	TO-220 (N.ISOL)
AC10ESM	Q6010LH5	S	TO-220 (ISOL)
AC10FGML	Q6010RH5	S	TO-220 (N.ISOL)
AC10FSM	Q6010LH5	S	TO-220 (ISOL)
AC12BGML	Q2012RH5	S	TO-220 (N.ISOL)
AC12BSM	Q2012LH5	S	TO-220 (ISOL)
AC12DGML	Q4012RH5	S	TO-220 (N.ISOL)
AC12DSM	Q4012LH5	S	TO-220 (ISOL)
AC12EGML	Q6012RH5	S	TO-220 (N.ISOL)
AC12ESM	Q6012LH5	S	TO-220 (ISOL)
AC12FGML	Q6012RH5	S	TO-220 (N.ISOL)
AC12FSM	Q6012LH5	S	TO-220 (ISOL)
AC16BGM	Q2015R5	S	TO-220 (N.ISOL)
AC16BSM	Q2015L5	S	TO-220 (ISOL)
AC16DGM	Q4015R5	S	TO-220 (N.ISOL)
AC16DSM	Q4015L5	S	TO-220 (ISOL)
AC16EGM	Q6015R5	S	TO-220 (N.ISOL)
AC16ESM	Q6015L5	S	TO-220 (ISOL)
AC16FGM	Q6015R5	S	TO-220 (N.ISOL)
AC16FSM	Q6015L5	S	TO-220 (ISOL)
AC25B1FL	Q6025P5	S	FASTPAK (ISOL)
AC25D1FL	Q6025P5	S	FASTPAK (ISOL)
AC25E1FL	Q6025P5	S	FASTPAK (ISOL)
AC25F1FL	Q6025P5	S	FASTPAK (ISOL)
BCR3AS-12	Q6006DH3	D	TO-252 (SMT)
BCR3AS-8	Q4006DH3	D	TO-252 (SMT)
BT131W-600	L6N3	S	SOT223 / COMPAK
BT136-500	Q6004F41	S	TO-202 (N.ISOL)
BT136-500D	L6004F61	S	TO-202 (N.ISOL)
BT136-500E	L6004F81	S	TO-202 (N.ISOL)
BT136-500F	Q6004F41	S	TO-202 (N.ISOL)
BT136-500G	Q6004F41	S	TO-202 (N.ISOL)
BT136-600	Q6004F41	S	TO-202 (N.ISOL)
BT136-600D	L6004F61	S	TO-202 (N.ISOL)
BT136-600E	L6004F81	S	TO-202 (N.ISOL)
BT136-600F	Q6004F41	S	TO-202 (N.ISOL)
BT136-600G	Q6004F41	S	TO-202 (N.ISOL)
BT136-800	Q8004L4	S	TO-220 (ISOL)
BT136-800F	Q8004L4	S	TO-220 (ISOL)
BT136-800G	Q8004L4	S	TO-220 (ISOL)
BT136F-500	Q6004L4	S	TO-220 (ISOL)
BT136F-500D	L6004L6	S	TO-220 (ISOL)
BT136F-500E	L6004L8	S	TO-220 (ISOL)
BT136F-500F	Q6004L4	S	TO-220 (ISOL)
BT136F-500G	Q6004L4	S	TO-220 (ISOL)
BT136F-600	Q6004L4	S	TO-220 (ISOL)

Part Number	Teccor Device	Direct or Suggested Replacement	Teccor Package
BT136F-600D	L6004L6	S	TO-220 (ISOL)
BT136F-600E	L6004L8	S	TO-220 (ISOL)
BT136F-600F	Q6004L4	S	TO-220 (ISOL)
BT136F-600G	Q6004L4	S	TO-220 (ISOL)
BT136F-800	Q8004L4	S	TO-220 (ISOL)
BT136F-800F	Q8004L4	S	TO-220 (ISOL)
BT136F-800G	Q8004L4	S	TO-220 (ISOL)
BT136S-600D	L6004D5	S	TO-252 (SMT)
BT136S-600E	L6004D6	S	TO-252 (SMT)
BT136S-600F	L6004D8	S	TO-252 (SMT)
BT136X-500	Q6004L4	S	TO-220 (ISOL)
BT136X-500D	L6004L6	S	TO-220 (ISOL)
BT136X-500E	L6004L8	S	TO-220 (ISOL)
BT136X-500F	Q6004L4	S	TO-220 (ISOL)
BT136X-500G	Q6004L4	S	TO-220 (ISOL)
BT136X-600	Q6004L4	S	TO-220 (ISOL)
BT136X-600D	L6004L6	S	TO-220 (ISOL)
BT136X-600E	L6004L8	S	TO-220 (ISOL)
BT136X-600F	Q6004L4	S	TO-220 (ISOL)
BT136X-600G	Q6004L4	S	TO-220 (ISOL)
BT136X-800	Q8004L4	S	TO-220 (ISOL)
BT136X-800F	Q8004L4	S	TO-220 (ISOL)
BT136X-800G	Q8004L4	S	TO-220 (ISOL)
BT137-500	Q6008R4	S	TO-220 (N.ISOL)
BT137-500D	L6008L6	S	TO-220 (ISOL)
BT137-500E	L6008L8	S	TO-220 (ISOL)
BT137-500F	Q6008R4	S	TO-220 (N.ISOL)
BT137-500G	Q6008R4	S	TO-220 (N.ISOL)
BT137-600D	L6008L6	S	TO-220 (ISOL)
BT137-600E	L6008L8	S	TO-220 (ISOL)
BT137-600G	Q6008R5	S	TO-220 (N.ISOL)
BT137-800G	Q8008R5	S	TO-220 (N.ISOL)
BT137B-600	Q6010N4	S	TO-263 (SMT)
BT137B-600F	Q6010N4	S	TO-263 (SMT)
BT137F-500	Q6008L4	S	TO-220 (ISOL)
BT137F-500D	L6008L6	S	TO-220 (ISOL)
BT137F-500E	L6008L8	S	TO-220 (ISOL)
BT137F-500F	Q6008L4	S	TO-220 (ISOL)
BT137F-500G	Q6008L4	S	TO-220 (ISOL)
BT137F-600D	L6008L6	S	TO-220 (ISOL)
BT137F-600E	L6008L8	S	TO-220 (ISOL)
BT137F-600G	Q6008L5	S	TO-220 (ISOL)
BT137F-800G	Q8008L5	S	TO-220 (ISOL)
BT137S-600E	L6008D8	S	TO-252 (SMT)
BT137X-500	Q6008L4	S	TO-220 (ISOL)
BT137X-500D	L6008L6	S	TO-220 (ISOL)
BT137X-500E	L6008L8	S	TO-220 (ISOL)
BT137X-500F	Q6008L4	S	TO-220 (ISOL)
BT137X-500G	Q6008L4	S	TO-220 (ISOL)
BT137X-600D	L6008L6	S	TO-220 (ISOL)
BT137X-600E	L6008L8	S	TO-220 (ISOL)
BT137X-600G	Q6008L5	S	TO-220 (ISOL)
BT137X-800G	Q8008L5	S	TO-220 (ISOL)
BT138-500G	Q6015R5	S	TO-220 (N.ISOL)
BT138-600G	Q6015R5	S	TO-220 (N.ISOL)
BT138-800G	Q8015R5	S	TO-220 (N.ISOL)
BT138F-500G	Q6015L5	S	TO-220 (ISOL)
BT138F-600G	Q6015L5	S	TO-220 (ISOL)
BT138F-800G	Q8015L5	S	TO-220 (ISOL)
BT138X-500G	Q6015L5	S	TO-220 (ISOL)
BT138X-600G	Q6015L5	S	TO-220 (ISOL)
BT138X-800G	Q8015L5	S	TO-220 (ISOL)
BT139-500G	Q6015R5	S	TO-220 (N.ISOL)
BT139-600G	Q6015R5	S	TO-220 (N.ISOL)
BT139-800G	Q8015R5	S	TO-220 (N.ISOL)
BT139F-500G	Q6015L5	S	TO-220 (ISOL)
BT139F-600G	Q6015L5	S	TO-220 (ISOL)
BT139F-800G	Q8015L5	S	TO-220 (ISOL)
BT139X-500G	Q6015L5	S	TO-220 (ISOL)
BT139X-500H	Q6015L6	S	TO-220 (ISOL)

Part Number	Teccor Device	Direct or Suggested Replacement	Teccor Package
BT139X-600G	Q6015L5	S	TO-220 (ISOL)
BT139X-600H	Q6015L6	S	TO-220 (ISOL)
BT139X-800G	Q8015L5	S	TO-220 (ISOL)
BT139X-800H	Q8015L6	S	TO-220 (ISOL)
BT145-500R	Q6025R	S	TO-220 (N.ISOL)
BT145-600R	Q6025R	S	TO-220 (N.ISOL)
BT145-800R	Q8025R	S	TO-220 (N.ISOL)
BT149B	EC103B	S	TO-92 (ISOL)
BT149D	EC103D	S	TO-92 (ISOL)
BT149E	EC103M	S	TO-92 (ISOL)
BT149G	EC103M	S	TO-92 (ISOL)
BT150-500R	T106M1	S	TO-202 (N.ISOL)
BT150-600R	T106M1	S	TO-202 (N.ISOL)
BT150S-600R	S6004DS2	S	TO-252 (SMT)
BT151-500R	S6010R	S	TO-220 (N.ISOL)
BT151-650R	S8010R	S	TO-220 (N.ISOL)
BT151-800R	S8010R	S	TO-220 (N.ISOL)
BT151S-500R	S6012D	S	TO-252 (SMT)
BT151S-650R	S8012D	S	TO-252 (SMT)
BT151X-500	S6010L	S	TO-220 (ISOL)
BT151X-650	S8010L	S	TO-220 (ISOL)
BT151X-800	S8010L	S	TO-220 (ISOL)
BT152-400R	S4020L	S	TO-220 (ISOL)
BT152-600R	S6020L	S	TO-220 (ISOL)
BT152-800R	S8020L	S	TO-220 (ISOL)
BT152B-400R	S4025N	S	TO-263 (SMT)
BT152B-600R	S6025N	S	TO-263 (SMT)
BT152B-800R	S8025N	S	TO-263 (SMT)
BT168B	EC103B	S	TO-92 (ISOL)
BT168D	EC103D	S	TO-92 (ISOL)
BT168E	EC103M	S	TO-92 (ISOL)
BT168G	EC103M	S	TO-92 (ISOL)
BT169B	EC103B	D	TO-92 (ISOL)
BT169D	EC103D	D	TO-92 (ISOL)
BT169E	EC103M	D	TO-92 (ISOL)
BT169G	EC103M	D	TO-92 (ISOL)
BT300-500R	S6008R	S	TO-220 (N.ISOL)
BT300-600R	S6008R	S	TO-220 (N.ISOL)
BT300-800R	S8008R	S	TO-220 (N.ISOL)
BT300S-600R	S6008D	D	TO-252 (SMT)
BTA04-200A	L2004L8	D	TO-220 (ISOL)
BTA04-200D	L2004L6	D	TO-220 (ISOL)
BTA04-200GP	L2004L6	S	TO-220 (ISOL)
BTA04-200S	L2004L6	D	TO-220 (ISOL)
BTA04-200T	L2004L5	D	TO-220 (ISOL)
BTA04-400A	L4004L8	D	TO-220 (ISOL)
BTA04-400D	L4004L6	D	TO-220 (ISOL)
BTA04-400GP	L4004L6	S	TO-220 (ISOL)
BTA04-400S	L4004L6	D	TO-220 (ISOL)
BTA04-400T	L4004L5	D	TO-220 (ISOL)
BTA04-600A	L6004L8	D	TO-220 (ISOL)
BTA04-600D	L6004L6	D	TO-220 (ISOL)
BTA04-600GP	L6004L6	S	TO-220 (ISOL)
BTA04-600S	L6004L6	D	TO-220 (ISOL)
BTA04-600T	L6004L5	D	TO-220 (ISOL)
BTA06-200A	L2006L8	D	TO-220 (ISOL)
BTA06-200B	Q2006L4	S	TO-220 (ISOL)
BTA06-200C	Q2006L4	S	TO-220 (ISOL)
BTA06-200D	L2006L6	D	TO-220 (ISOL)
BTA06-200GP	L2006L6	S	TO-220 (ISOL)
BTA06-200S	L2006L6	D	TO-220 (ISOL)
BTA06-200SW	L2006L8	D	TO-220 (ISOL)
BTA06-200T	L2006L5	S	TO-220 (ISOL)
BTA06-200TW	L2006L6	D	TO-220 (ISOL)
BTA06-400A	L4006L8	D	TO-220 (ISOL)
BTA06-400B	Q4006L4	S	TO-220 (ISOL)
BTA06-400BW	Q4006L4	S	TO-220 (ISOL)
BTA06-400C	Q4006L4	S	TO-220 (ISOL)
BTA06-400CW	Q4006L4	D	TO-220 (ISOL)
BTA06-400D	L4006L6	D	TO-220 (ISOL)

Part Number	Teccor Device	Direct or Suggested Replacement	Teccor Package
BTA06-400GP	L4006L6	S	TO-220 (ISOL)
BTA06-400S	L4006L6	D	TO-220 (ISOL)
BTA06-400SW	L4006L8	D	TO-220 (ISOL)
BTA06-400T	L4006L5	S	TO-220 (ISOL)
BTA06-400TW	L4006L6	D	TO-220 (ISOL)
BTA06-600A	L6006L8	D	TO-220 (ISOL)
BTA06-600B	Q6006L5	S	TO-220 (ISOL)
BTA06-600BW	Q6006LH4	S	TO-220 (ISOL)
BTA06-600C	Q6006L5	S	TO-220 (ISOL)
BTA06-600CW	Q6006LH4	S	TO-220 (ISOL)
BTA06-600D	L6006L6	D	TO-220 (ISOL)
BTA06-600GP	L6006L6	S	TO-220 (ISOL)
BTA06-600S	L6006L6	D	TO-220 (ISOL)
BTA06-600SW	L6006L8	D	TO-220 (ISOL)
BTA06-600T	L6006L5	S	TO-220 (ISOL)
BTA06-600TW	L6006L6	D	TO-220 (ISOL)
BTA06-700B	Q8006L5	S	TO-220 (ISOL)
BTA06-700BW	Q8006LH4	S	TO-220 (ISOL)
BTA06-700C	Q8006L5	D	TO-220 (ISOL)
BTA06-700CW	Q7006LH4	D	TO-220 (ISOL)
BTA06-800B	Q8006L5	S	TO-220 (ISOL)
BTA06-800BW	Q8006LH4	S	TO-220 (ISOL)
BTA06-800C	Q8006L5	S	TO-220 (ISOL)
BTA06-800CW	Q8006LH4	D	TO-220 (ISOL)
BTA08-200A	L2008L8	D	TO-220 (ISOL)
BTA08-200B	Q2008L4	S	TO-220 (ISOL)
BTA08-200C	Q2008L4	S	TO-220 (ISOL)
BTA08-200S	L2008L6	D	TO-220 (ISOL)
BTA08-200SW	L2008L8	D	TO-220 (ISOL)
BTA08-200TW	L2008L6	D	TO-220 (ISOL)
BTA08-400A	L4008L8	D	TO-220 (ISOL)
BTA08-400B	Q4008L4	S	TO-220 (ISOL)
BTA08-400BW	Q4008LH4	S	TO-220 (ISOL)
BTA08-400C	Q4008L4	S	TO-220 (ISOL)
BTA08-400CW	Q4008LH4	D	TO-220 (ISOL)
BTA08-400S	L4008L6	D	TO-220 (ISOL)
BTA08-400SW	L4008L8	D	TO-220 (ISOL)
BTA08-400TW	L4008L6	D	TO-220 (ISOL)
BTA08-600A	L6008L8	D	TO-220 (ISOL)
BTA08-600B	Q6008L5	S	TO-220 (ISOL)
BTA08-600BW	Q6008LH4	S	TO-220 (ISOL)
BTA08-600C	Q6008L5	S	TO-220 (ISOL)
BTA08-600CW	Q6008LH4	D	TO-220 (ISOL)
BTA08-600S	L6008L6	D	TO-220 (ISOL)
BTA08-600SW	L6008L8	D	TO-220 (ISOL)
BTA08-600TW	L6008L6	D	TO-220 (ISOL)
BTA08-700B	Q8008L5	S	TO-220 (ISOL)
BTA08-700BW	Q8008LH4	S	TO-220 (ISOL)
BTA08-700C	Q8008L5	S	TO-220 (ISOL)
BTA08-700CW	Q8008LH4	D	TO-220 (ISOL)
BTA08-800B	Q8008L5	S	TO-220 (ISOL)
BTA08-800BW	Q8008LH4	S	TO-220 (ISOL)
BTA08-800C	Q8008L5	S	TO-220 (ISOL)
BTA08-800CW	Q8008LH4	D	TO-220 (ISOL)
BTA10-200AW	Q2010L5	S	TO-220 (ISOL)
BTA10-200B	Q2010L5	S	TO-220 (ISOL)
BTA10-200BW	Q2010LH5	D	TO-220 (ISOL)
BTA10-200C	Q2010L5	S	TO-220 (ISOL)
BTA10-200CW	Q2010LH5	S	TO-220 (ISOL)
BTA10-400AW	Q4010L5	S	TO-220 (ISOL)
BTA10-400B	Q4010L5	S	TO-220 (ISOL)
BTA10-400BW	Q4010LH5	D	TO-220 (ISOL)
BTA10-400C	Q4010L5	S	TO-220 (ISOL)
BTA10-400CW	Q4010LH5	S	TO-220 (ISOL)
BTA10-400GP	Q4010L4	S	TO-220 (ISOL)
BTA10-600AW	Q6010L5	S	TO-220 (ISOL)
BTA10-600B	Q6010L5	S	TO-220 (ISOL)
BTA10-600BW	Q6010LH5	D	TO-220 (ISOL)
BTA10-600C	Q6010L5	S	TO-220 (ISOL)
BTA10-600CW	Q6010LH5	S	TO-220 (ISOL)

Part Number	Teccor Device	Direct or Suggested Replacement	Teccor Package
BTA10-600GP	Q6010L4	S	TO-220 (ISOL)
BTA10-700AW	Q8010L5	S	TO-220 (ISOL)
BTA10-700B	Q8010L5	S	TO-220 (ISOL)
BTA10-700BW	Q8010LH5	D	TO-220 (ISOL)
BTA10-700C	Q8010L5	S	TO-220 (ISOL)
BTA10-700CW	Q8010LH5	S	TO-220 (ISOL)
BTA10-800B	Q8010L5	S	TO-220 (ISOL)
BTA10-800BW	Q8010LH5	D	TO-220 (ISOL)
BTA10-800C	Q8010L5	S	TO-220 (ISOL)
BTA10-800CW	Q8010LH5	S	TO-220 (ISOL)
BTA12-200AW	Q2012LH5	D	TO-220 (ISOL)
BTA12-200B	Q2015L5	S	TO-220 (ISOL)
BTA12-200BW	Q4012LH5	D	TO-220 (ISOL)
BTA12-200C	Q2015L5	S	TO-220 (ISOL)
BTA12-400AW	Q4012LH5	D	TO-220 (ISOL)
BTA12-400B	Q4015L5	S	TO-220 (ISOL)
BTA12-400BW	Q4012LH5	D	TO-220 (ISOL)
BTA12-400C	Q4015L5	S	TO-220 (ISOL)
BTA12-400CW	Q4012LH5	S	TO-220 (ISOL)
BTA12-600AW	Q6012LH5	D	TO-220 (ISOL)
BTA12-600B	Q6015L5	S	TO-220 (ISOL)
BTA12-600BW	Q6012LH5	D	TO-220 (ISOL)
BTA12-600C	Q6015L5	S	TO-220 (ISOL)
BTA12-600CW	Q6012LH5	S	TO-220 (ISOL)
BTA12-700AW	Q8012LH5	D	TO-220 (ISOL)
BTA12-700B	Q8015L5	S	TO-220 (ISOL)
BTA12-700BW	Q8012LH5	D	TO-220 (ISOL)
BTA12-700C	Q8015L5	S	TO-220 (ISOL)
BTA12-700CW	Q8012LH5	S	TO-220 (ISOL)
BTA12-800B	Q8015L5	S	TO-220 (ISOL)
BTA12-800BW	Q8012LH5	S	TO-220 (ISOL)
BTA12-800C	Q8015L5	S	TO-220 (ISOL)
BTA12-800CW	Q8012LH5	S	TO-220 (ISOL)
BTA13-200B	Q2015L5	S	TO-220 (ISOL)
BTA13-400B	Q4015L5	S	TO-220 (ISOL)
BTA13-600B	Q6015L5	S	TO-220 (ISOL)
BTA13-700B	Q8015L5	S	TO-220 (ISOL)
BTA13-800B	Q8015L5	S	TO-220 (ISOL)
BTA140-500	Q6025R5	S	TO-220 (N.ISOL)
BTA140-600	Q6025R5	S	TO-220 (N.ISOL)
BTA140-800	Q8025R5	S	TO-220 (N.ISOL)
BTA16-200AW	Q2016LH6	S	TO-220 (ISOL)
BTA16-200B	Q2015L5	S	TO-220 (ISOL)
BTA16-200BW	Q2016LH4	S	TO-220 (ISOL)
BTA16-400AW	Q2016LH6	S	TO-220 (ISOL)
BTA16-400B	Q2015L5	S	TO-220 (ISOL)
BTA16-400BW	Q2016LH4	S	TO-220 (ISOL)
BTA16-400CW	Q4016LH4	S	TO-220 (ISOL)
BTA16-600AW	Q6016LH6	S	TO-220 (ISOL)
BTA16-600B	Q6015L5	S	TO-220 (ISOL)
BTA16-600BW	Q6016LH4	S	TO-220 (ISOL)
BTA16-600CW	Q6016LH4	S	TO-220 (ISOL)
BTA16-700AW	Q8016LH6	S	TO-220 (ISOL)
BTA16-700B	Q8015L5	S	TO-220 (ISOL)
BTA16-700BW	Q8016LH4	S	TO-220 (ISOL)
BTA16-700CW	Q8016LH4	S	TO-220 (ISOL)
BTA16-800AW	Q8016LH6	S	TO-220 (ISOL)
BTA16-800B	Q8015L5	S	TO-220 (ISOL)
BTA16-800BW	Q8016LH4	S	TO-220 (ISOL)
BTA16-800CW	Q8016LH4	S	TO-220 (ISOL)
BTA20-400BW	Q4025L6	S	TO-220 (ISOL)
BTA20-400CW	Q4025L6	S	TO-220 (ISOL)
BTA204S-600C	Q6006DH4	D	TO-252 (SMT)
BTA204S-600E	Q6006DH3	D	TO-252 (SMT)
BTA20-600BW	Q6025L6	S	TO-220 (ISOL)
BTA20-600CW	Q6025L6	S	TO-220 (ISOL)
BTA20-700BW	Q8025L6	S	TO-220 (ISOL)
BTA20-700CW	Q8025L6	S	TO-220 (ISOL)
BTA20-800BW	Q8025L6	S	TO-220 (ISOL)
BTA20-800CW	Q8025L6	S	TO-220 (ISOL)

Part Number	Teccor Device	Direct or Suggested Replacement	Teccor Package
BTA208-600B	Q6008RH4	S	TO-220 (N.ISOL)
BTA208-800B	Q8008RH4	S	TO-220 (N.ISOL)
BTA208S-600E	Q6008DH3	D	TO-252 (SMT)
BTA208S-800C	Q8008DH4	D	TO-252 (SMT)
BTA208X-600B	Q6008LH4	S	TO-220 (ISOL)
BTA208X-800B	Q8008LH4	S	TO-220 (ISOL)
BTA20C	Q4006R4	D	TO-220 (N.ISOL)
BTA20D	Q4006R4	D	TO-220 (N.ISOL)
BTA20E	Q6006R4	D	TO-220 (N.ISOL)
BTA20M	Q6006R5	D	TO-220 (N.ISOL)
BTA20N	Q8006R5	D	TO-220 (N.ISOL)
BTA212-600B	Q6012RH5	S	TO-220 (N.ISOL)
BTA212-800B	Q8012RH5	S	TO-220 (N.ISOL)
BTA212B-600B	Q6012NH5	D	TO-263 (SMT)
BTA212B-800B	Q8012NH5	D	TO-263 (SMT)
BTA212X-600B	Q6012LH5	S	TO-220 (ISOL)
BTA212X-800B	Q8012LH5	S	TO-220 (ISOL)
BTA216-600B	Q6015R6	S	TO-220 (N.ISOL)
BTA216-800B	Q8015R6	S	TO-220 (N.ISOL)
BTA216B-600	Q6016NH4	S	TO-263 (SMT)
BTA216X-600B	Q6015L6	S	TO-220 (ISOL)
BTA216X-800B	Q8015L6	S	TO-220 (ISOL)
BTA21C	Q4008R4	D	TO-220 (N.ISOL)
BTA21D	Q4008R4	D	TO-220 (N.ISOL)
BTA21E	Q6008R4	D	TO-220 (N.ISOL)
BTA21M	Q6008R5	S	TO-220 (N.ISOL)
BTA21N	Q8008R5	S	TO-220 (N.ISOL)
BTA225-600B	Q6025R6	S	TO-220 (N.ISOL)
BTA225-800B	Q8025R6	S	TO-220 (N.ISOL)
BTA225B-600B	Q6025NH6	S	TO-263 (SMT)
BTA225B-800B	Q8025NH6	S	TO-263 (SMT)
BTA22B	Q2010R5	S	TO-220 (N.ISOL)
BTA22C	Q4010R5	S	TO-220 (N.ISOL)
BTA22D	Q4010R5	S	TO-220 (N.ISOL)
BTA22E	Q5010R5	S	TO-220 (N.ISOL)
BTA22M	Q6010R5	S	TO-220 (N.ISOL)
BTA23B	Q2015R5	S	TO-220 (N.ISOL)
BTA23C	Q4015R5	S	TO-220 (N.ISOL)
BTA23D	Q4015R5	S	TO-220 (N.ISOL)
BTA23E	Q5015R5	S	TO-220 (N.ISOL)
BTA23M	Q6015R5	S	TO-220 (N.ISOL)
BTA24-600BW	Q6025L6	S	TO-220 (ISOL)
BTA24-600CW	Q6025L6	S	TO-220 (ISOL)
BTA24-700BW	Q8025L6	S	TO-220 (ISOL)
BTA24-700CW	Q8025L6	S	TO-220 (ISOL)
BTA24-800BW	Q8025L6	S	TO-220 (ISOL)
BTA24-800CW	Q8025L6	S	TO-220 (ISOL)
BTA25-200A	Q6025P5	S	FASTPAK (ISOL)
BTA25-200B	Q6025P5	S	FASTPAK (ISOL)
BTA25-400A	Q6025P5	S	FASTPAK (ISOL)
BTA25-400B	Q6025P5	S	FASTPAK (ISOL)
BTA25-600A	Q6025P5	S	FASTPAK (ISOL)
BTA25-600B	Q6025P5	S	FASTPAK (ISOL)
BTA25-600BW	Q6025P5	S	FASTPAK (ISOL)
BTA25-600CW	Q6025P5	S	FASTPAK (ISOL)
BTA25-700A	Q8025P5	S	FASTPAK (ISOL)
BTA25-700B	Q8025P5	S	FASTPAK (ISOL)
BTA25-800A	Q8025P5	S	FASTPAK (ISOL)
BTA25-800B	Q8025P5	S	FASTPAK (ISOL)
BTA25-800BW	Q8025P5	S	FASTPAK (ISOL)
BTA25-800CW	Q8025P5	S	FASTPAK (ISOL)
BTA26-200A	Q2025K6	S	TO-218 (ISOL)
BTA26-200B	Q2025K6	S	TO-218 (ISOL)
BTA26-400A	Q4025K6	S	TO-218 (ISOL)
BTA26-400B	Q4025K6	S	TO-218 (ISOL)
BTA26-400BW	Q4025K6	S	TO-218 (ISOL)
BTA26-400CW	Q4025K6	S	TO-218 (ISOL)
BTA26-600A	Q6025K6	S	TO-218 (ISOL)
BTA26-600B	Q6025K6	S	TO-218 (ISOL)
BTA26-600BW	Q6025K6	S	TO-218 (ISOL)

Part Number	Teccor Device	Direct or Suggested Replacement	Teccor Package
BTA26-600CW	Q6025K6	S	TO-218 (ISOL)
BTA26-700A	Q8025K6	S	TO-218 (ISOL)
BTA26-700B	Q8025K6	S	TO-218 (ISOL)
BTA26-700BW	Q8025K6	S	TO-218 (ISOL)
BTA26-700CW	Q8025K6	S	TO-218 (ISOL)
BTA26-800A	Q8025K6	S	TO-218 (ISOL)
BTA26-800B	Q8025K6	S	TO-218 (ISOL)
BTA26-800BW	Q8025K6	S	TO-218 (ISOL)
BTA26-800CW	Q8025K6	S	TO-218 (ISOL)
BTA40-200A	Q6035P5	S	FASTPAK (ISOL)
BTA40-200B	Q6035P5	S	FASTPAK (ISOL)
BTA40-400A	Q6035P5	S	FASTPAK (ISOL)
BTA40-400B	Q6035P5	S	FASTPAK (ISOL)
BTA40-600A	Q6035P5	S	FASTPAK (ISOL)
BTA40-600B	Q6035P5	S	FASTPAK (ISOL)
BTA40-700A	Q8035P5	S	FASTPAK (ISOL)
BTA40-700B	Q8035P5	S	FASTPAK (ISOL)
BTA41-200A	Q2040K7	S	TO-218 (ISOL)
BTA41-200B	Q2040K7	S	TO-218 (ISOL)
BTA41-400A	Q4040K7	S	TO-218 (ISOL)
BTA41-400B	Q4040K7	S	TO-218 (ISOL)
BTA41-600A	Q6040K7	S	TO-218 (ISOL)
BTA41-600B	Q6040K7	S	TO-218 (ISOL)
BTA41-700A	Q8040K7	S	TO-218 (ISOL)
BTA41-700B	Q8040K7	S	TO-218 (ISOL)
BTA41-800A	Q8040K7	S	TO-218 (ISOL)
BTA41-800B	Q8040K7	S	TO-218 (ISOL)
BTB04-200A	L2004F81	S	TO-202 (N.ISOL)
BTB04-200D	L2004F61	S	TO-202 (N.ISOL)
BTB04-200S	L2004F61	S	TO-202 (N.ISOL)
BTB04-200T	L2004F51	S	TO-202 (N.ISOL)
BTB04-400A	L4004F81	S	TO-202 (N.ISOL)
BTB04-400D	L4004F61	S	TO-202 (N.ISOL)
BTB04-400S	L4004F61	S	TO-202 (N.ISOL)
BTB04-400T	L4004F51	S	TO-202 (N.ISOL)
BTB04-600A	L6004F61	S	TO-202 (N.ISOL)
BTB04-600D	L6004F61	S	TO-202 (N.ISOL)
BTB04-600S	L6004F81	S	TO-202 (N.ISOL)
BTB04-600T	L6004F51	S	TO-202 (N.ISOL)
BTB06-200A	L2006L8	S	TO-220 (ISOL)
BTB06-200B	Q2006R4	S	TO-220 (N.ISOL)
BTB06-200C	Q2006R4	S	TO-220 (N.ISOL)
BTB06-200D	L2006L6	S	TO-220 (ISOL)
BTB06-200S	L2006L6	S	TO-220 (ISOL)
BTB06-200T	L2006L5	S	TO-220 (ISOL)
BTB06-400A	L4006L8	S	TO-220 (ISOL)
BTB06-400B	Q4006R4	S	TO-220 (N.ISOL)
BTB06-400BW	Q4006RH4	S	TO-220 (N.ISOL)
BTB06-400C	Q4006R4	S	TO-220 (N.ISOL)
BTB06-400CW	Q4006RH4	S	TO-220 (N.ISOL)
BTB06-400D	L4006L6	S	TO-220 (ISOL)
BTB06-400S	L4006L6	S	TO-220 (ISOL)
BTB06-400T	L4006L5	S	TO-220 (ISOL)
BTB06-600A	L6006L8	S	TO-220 (ISOL)
BTB06-600B	Q6006R5	S	TO-220 (N.ISOL)
BTB06-600BW	Q6006RH4	S	TO-220 (N.ISOL)
BTB06-600C	Q6006R5	S	TO-220 (N.ISOL)
BTB06-600CW	Q6006RH4	S	TO-220 (N.ISOL)
BTB06-600D	L6006L6	S	TO-220 (ISOL)
BTB06-600S	L6006L6	S	TO-220 (ISOL)
BTB06-600T	L6006L5	S	TO-220 (ISOL)
BTB06-700B	Q8006R5	S	TO-220 (N.ISOL)
BTB06-700BW	Q8006RH4	S	TO-220 (N.ISOL)
BTB06-700C	Q8006R5	S	TO-220 (N.ISOL)
BTB06-700CW	Q8006RH4	S	TO-220 (N.ISOL)
BTB06-800B	Q8006R5	S	TO-220 (N.ISOL)
BTB06-800BW	Q8006RH4	S	TO-220 (N.ISOL)
BTB06-800C	Q8006R5	S	TO-220 (N.ISOL)
BTB06-800CW	Q8006RH4	S	TO-220 (N.ISOL)
BTB08-200A	L2008L8	S	TO-220 (ISOL)

Part Number	Teccor Device	Direct or Suggested Replacement	Teccor Package
BTB08-200B	Q2008R4	S	TO-220 (N.ISOL)
BTB08-200C	Q2008R4	S	TO-220 (N.ISOL)
BTB08-200S	L2008L6	S	TO-220 (ISOL)
BTB08-400A	L4008L8	S	TO-220 (ISOL)
BTB08-400B	Q4008R4	S	TO-220 (N.ISOL)
BTB08-400BW	Q4008RH4	S	TO-220 (N.ISOL)
BTB08-400C	Q4008R4	S	TO-220 (N.ISOL)
BTB08-400CW	Q4008RH4	S	TO-220 (N.ISOL)
BTB08-400S	L4008L6	S	TO-220 (ISOL)
BTB08-600A	L6008L8	S	TO-220 (ISOL)
BTB08-600B	Q6008R5	S	TO-220 (N.ISOL)
BTB08-600BW	Q6008RH4	S	TO-220 (N.ISOL)
BTB08-600C	Q6008R5	S	TO-220 (N.ISOL)
BTB08-600CW	Q6008RH4	S	TO-220 (N.ISOL)
BTB08-600S	L6008L6	S	TO-220 (ISOL)
BTB08-700B	Q8008R5	S	TO-220 (N.ISOL)
BTB08-700BW	Q8008RH4	S	TO-220 (N.ISOL)
BTB08-700C	Q8008R5	S	TO-220 (N.ISOL)
BTB08-700CW	Q8008RH4	S	TO-220 (N.ISOL)
BTB08-800B	Q8008R5	S	TO-220 (N.ISOL)
BTB08-800BW	Q8008RH4	S	TO-220 (N.ISOL)
BTB08-800C	Q8008R5	S	TO-220 (N.ISOL)
BTB08-800CW	Q8008RH4	S	TO-220 (N.ISOL)
BTB10-200B	Q2010R5	S	TO-220 (N.ISOL)
BTB10-200C	Q2010R5	S	TO-220 (N.ISOL)
BTB10-400B	Q4010R5	S	TO-220 (N.ISOL)
BTB10-400BW	Q4010RH5	S	TO-220 (N.ISOL)
BTB10-400C	Q4010R5	S	TO-220 (N.ISOL)
BTB10-400CW	Q4010RH5	S	TO-220 (N.ISOL)
BTB10-600B	Q6010R5	S	TO-220 (N.ISOL)
BTB10-600BW	Q6010RH5	S	TO-220 (N.ISOL)
BTB10-600C	Q6010R5	S	TO-220 (N.ISOL)
BTB10-600CW	Q6010RH5	S	TO-220 (N.ISOL)
BTB10-700B	Q8010R5	S	TO-220 (N.ISOL)
BTB10-700BW	Q8010RH5	S	TO-220 (N.ISOL)
BTB10-700C	Q8010R5	S	TO-220 (N.ISOL)
BTB10-700CW	Q8010RH5	S	TO-220 (N.ISOL)
BTB10-800B	Q8010R5	S	TO-220 (N.ISOL)
BTB10-800BW	Q8010RH5	S	TO-220 (N.ISOL)
BTB10-800C	Q8010R5	S	TO-220 (N.ISOL)
BTB10-800CW	Q8010RH5	S	TO-220 (N.ISOL)
BTB12-200B	Q2015R5	S	TO-220 (N.ISOL)
BTB12-200C	Q2015R5	S	TO-220 (N.ISOL)
BTB12-400B	Q4015R5	S	TO-220 (N.ISOL)
BTB12-400BW	Q4012RH5	S	TO-220 (N.ISOL)
BTB12-400C	Q4015R5	S	TO-220 (N.ISOL)
BTB12-400CW	Q4012RH5	S	TO-220 (N.ISOL)
BTB12-400SW	Q4016RH3	S	TO-220 (N.ISOL)
BTB12-600B	Q6015R5	S	TO-220 (N.ISOL)
BTB12-600BW	Q6012RH5	S	TO-220 (N.ISOL)
BTB12-600C	Q6015R5	S	TO-220 (N.ISOL)
BTB12-600CW	Q6012RH5	S	TO-220 (N.ISOL)
BTB12-600SW	Q6016RH3	S	TO-220 (N.ISOL)
BTB12-700B	Q8015R5	S	TO-220 (N.ISOL)
BTB12-700BW	Q8012RH5	S	TO-220 (N.ISOL)
BTB12-700C	Q8015R5	S	TO-220 (N.ISOL)
BTB12-700CW	Q8012RH5	S	TO-220 (N.ISOL)
BTB12-700SW	Q8016RH3	S	TO-220 (N.ISOL)
BTB12-800B	Q8015R5	S	TO-220 (N.ISOL)
BTB12-800BW	Q8012RH5	S	TO-220 (N.ISOL)
BTB12-800C	Q8015R5	S	TO-220 (N.ISOL)
BTB12-800CW	Q8012RH5	S	TO-220 (N.ISOL)
BTB13-200B	Q2015R5	S	TO-220 (N.ISOL)
BTB13-400B	Q4015R5	S	TO-220 (N.ISOL)
BTB13-600B	Q6015R5	S	TO-220 (N.ISOL)
BTB13-700B	Q8015R5	S	TO-220 (N.ISOL)
BTB13-800B	Q8015R5	S	TO-220 (N.ISOL)
BTB15-200B	Q2015R5	S	TO-220 (N.ISOL)
BTB15-400B	Q4015R5	S	TO-220 (N.ISOL)
BTB15-600B	Q6015R5	S	TO-220 (N.ISOL)

Part Number	Teccor Device	Direct or Suggested Replacement	Teccor Package
BTB15-700B	Q8015R5	S	TO-220 (N.ISOL)
BTB16-200B	Q2015R5	S	TO-220 (N.ISOL)
BTB16-400B	Q4015R5	S	TO-220 (N.ISOL)
BTB16-400CW	Q4016RH4	S	TO-220 (N.ISOL)
BTB16-600B	Q6015R5	S	TO-220 (N.ISOL)
BTB16-600CW	Q6016RH4	S	TO-220 (N.ISOL)
BTB16-700B	Q8015R5	S	TO-220 (N.ISOL)
BTB16-700CW	Q8016RH4	S	TO-220 (N.ISOL)
BTB16-800B	Q8015R5	S	TO-220 (N.ISOL)
BTB16-800CW	Q8016RH4	S	TO-220 (N.ISOL)
BTB19-200B	Q2025R5	S	TO-220 (N.ISOL)
BTB19-400B	Q4025R5	S	TO-220 (N.ISOL)
BTB19-600B	Q6025R5	S	TO-220 (N.ISOL)
BTB19-700B	Q8025R5	S	TO-220 (N.ISOL)
BTB20-400BW	Q4025R6	S	TO-220 (N.ISOL)
BTB20-400CW	Q4025R6	S	TO-220 (N.ISOL)
BTB20-600BW	Q6025R6	S	TO-220 (N.ISOL)
BTB20-600CW	Q6025R6	S	TO-220 (N.ISOL)
BTB20-700BW	Q8025R6	S	TO-220 (N.ISOL)
BTB20-700CW	Q8025R6	S	TO-220 (N.ISOL)
BTB20-800BW	Q8025R6	S	TO-220 (N.ISOL)
BTB20-800CW	Q8025R6	S	TO-220 (N.ISOL)
BTB24-200B	Q2025R5	S	TO-220 (N.ISOL)
BTB24-400B	Q4025R5	S	TO-220 (N.ISOL)
BTB24-600B	Q6025R5	S	TO-220 (N.ISOL)
BTB24-600BW	Q6025R6	S	TO-220 (N.ISOL)
BTB24-700B	Q8025R5	S	TO-220 (N.ISOL)
BTB24-800B	Q8025R5	S	TO-220 (N.ISOL)
BTB26-200A	Q2025K6	S	TO-218 (ISOL)
BTB26-200B	Q2025K6	S	TO-218 (ISOL)
BTB26-400A	Q4025K6	S	TO-218 (ISOL)
BTB26-400B	Q4025K6	S	TO-218 (ISOL)
BTB26-600A	Q6025K6	S	TO-218 (ISOL)
BTB26-600B	Q6025K6	S	TO-218 (ISOL)
BTB26-700A	Q8025K6	S	TO-218 (ISOL)
BTB26-700B	Q8025K6	S	TO-218 (ISOL)
BTB26-800B	Q8025K6	S	TO-218 (ISOL)
BTB41-200A	Q2040K7	S	TO-218 (ISOL)
BTB41-200B	Q2040K7	S	TO-218 (ISOL)
BTB41-400A	Q4040K7	S	TO-218 (ISOL)
BTB41-400B	Q4040K7	S	TO-218 (ISOL)
BTB41-600A	Q6040K7	S	TO-218 (ISOL)
BTB41-600B	Q6040K7	S	TO-218 (ISOL)
BTB41-700A	Q8040K7	S	TO-218 (ISOL)
BTB41-700B	Q8040K7	S	TO-218 (ISOL)
BTB41-800A	Q8040K7	S	TO-218 (ISOL)
BTB41-800B	Q8040K7	S	TO-218 (ISOL)
BTW41-500G	Q6035P5	S	FASTPAK (ISOL)
BTW41-600G	Q6035P5	S	FASTPAK (ISOL)
BTW66-200	S2035J	S	TO-218 (ISOL)
BTW66-400	S4035J	S	TO-218 (ISOL)
BTW66-600	S6035J	S	TO-218 (ISOL)
BTW66-800	S8035J	S	TO-218 (ISOL)
BTW67-200	S2065J	S	TO-218 (ISOL)
BTW67-400	S4065J	S	TO-218 (ISOL)
BTW67-600	S6065J	S	TO-218 (ISOL)
BTW67-800	S8065J	S	TO-218 (ISOL)
BTW68-200	S2035K	D	TO-218 (ISOL)
BTW68-200N	S2035K	S	TO-218 (ISOL)
BTW68-400	S4035K	D	TO-218 (ISOL)
BTW68-400N	S4035K	S	TO-218 (ISOL)
BTW68-600	S6035K	D	TO-218 (ISOL)
BTW68-600N	S6035K	S	TO-218 (ISOL)
BTW68-800	S8035K	D	TO-218 (ISOL)
BTW68-800N	S8035K	S	TO-218 (ISOL)
BTW69-200	S2065K	D	TO-218 (ISOL)
BTW69-200N	S2055M	D	TO-218 (N.ISOL)
BTW69-400	S4065K	D	TO-218 (ISOL)
BTW69-400N	S4055M	D	TO-218 (N.ISOL)
BTW69-600	S6065K	D	TO-218 (ISOL)

Part Number	Teccor Device	Direct or Suggested Replacement	Teccor Package
BTW69-600N	S6055M	D	TO-218 (N.ISOL)
BTW69-800	S8065K	D	TO-218 (ISOL)
BTW69-800N	S8055M	D	TO-218 (N.ISOL)
BTW70-200N	S2070W	S	TO-218 (N.ISOL)
BTW70-400N	S4070W	S	TO-218 (N.ISOL)
BTW70-600N	S6070W	S	TO-218 (N.ISOL)
BYW80-100	D2020L	S	TO-220 (ISOL)
BYW80-150	D2020L	S	TO-220 (ISOL)
BYW80-200	D2020L	S	TO-220 (ISOL)
BYW80-50	D2020L	S	TO-220 (ISOL)
C103A	EC103B	S	TO-92 (ISOL)
C103B	EC103B	S	TO-92 (ISOL)
C103D	EC103D	S	TO-92 (ISOL)
C103E	EC103M	S	TO-92 (ISOL)
C103M	EC103M	S	TO-92 (ISOL)
C103Y	EC103B	S	TO-92 (ISOL)
C103YY	EC103B	S	TO-92 (ISOL)
C106A	T106B1	S	TO-202 (N.ISOL)
C106A1	T106B1	S	TO-202 (N.ISOL)
C106A11	T106B11	S	TO-202 (N.ISOL)
C106A12	T106B12	S	TO-202 (N.ISOL)
C106A2	T106B2	S	TO-202 (N.ISOL)
C106A21	T106B21	S	TO-202 (N.ISOL)
C106A3	T106B3	S	TO-202 (N.ISOL)
C106A32	T106B32	S	TO-202 (N.ISOL)
C106A4	T106B4	S	TO-202 (N.ISOL)
C106A41	T106B41	S	TO-202 (N.ISOL)
C106B	T106B1	S	TO-202 (N.ISOL)
C106B1	T106B1	S	TO-202 (N.ISOL)
C106B11	T106B11	S	TO-202 (N.ISOL)
C106B12	T106B12	S	TO-202 (N.ISOL)
C106B2	T106B2	S	TO-202 (N.ISOL)
C106B21	T106B21	S	TO-202 (N.ISOL)
C106B3	T106B3	S	TO-202 (N.ISOL)
C106B32	T106B32	S	TO-202 (N.ISOL)
C106B4	T106B4	S	TO-202 (N.ISOL)
C106B41	T106B41	S	TO-202 (N.ISOL)
C106C	T106D	S	TO-202 (N.ISOL)
C106C1	T106D1	S	TO-202 (N.ISOL)
C106C11	T106D11	S	TO-202 (N.ISOL)
C106C12	T106D12	S	TO-202 (N.ISOL)
C106C2	T106D2	S	TO-202 (N.ISOL)
C106C21	T106D1	S	TO-202 (N.ISOL)
C106C3	T106D3	S	TO-202 (N.ISOL)
C106C32	T106D32	S	TO-202 (N.ISOL)
C106C4	T106D4	S	TO-202 (N.ISOL)
C106C41	T106D41	S	TO-202 (N.ISOL)
C106D	T106D1	S	TO-202 (N.ISOL)
C106D1	T106D1	S	TO-202 (N.ISOL)
C106D11	T106D11	S	TO-202 (N.ISOL)
C106D12	T106D12	S	TO-202 (N.ISOL)
C106D2	T106D2	S	TO-202 (N.ISOL)
C106D21	T106D21	S	TO-202 (N.ISOL)
C106D3	T106D3	S	TO-202 (N.ISOL)
C106D32	T106D32	S	TO-202 (N.ISOL)
C106D4	T106D4	S	TO-202 (N.ISOL)
C106D41	T106D41	S	TO-202 (N.ISOL)
C106E	T106M1	S	TO-202 (N.ISOL)
C106E1	T106M1	S	TO-202 (N.ISOL)
C106E11	T106M11	S	TO-202 (N.ISOL)
C106E12	T106M12	S	TO-202 (N.ISOL)
C106E2	T106M2	S	TO-202 (N.ISOL)
C106E21	T106M21	S	TO-202 (N.ISOL)
C106E3	T106M3	S	TO-202 (N.ISOL)
C106E32	T106M32	S	TO-202 (N.ISOL)
C106E4	T106M4	S	TO-202 (N.ISOL)
C106E41	T106M41	S	TO-202 (N.ISOL)
C106F	T106B1	S	TO-202 (N.ISOL)
C106F1	T106B1	S	TO-202 (N.ISOL)
C106F11	T106B11	S	TO-202 (N.ISOL)

Part Number	Teccor Device	Direct or Suggested Replacement	Teccor Package
C106F12	T106B12	S	TO-202 (N.ISOL)
C106F2	T106B2	S	TO-202 (N.ISOL)
C106F21	T106B21	S	TO-202 (N.ISOL)
C106F3	T106B3	S	TO-202 (N.ISOL)
C106F32	T106B32	S	TO-202 (N.ISOL)
C106F4	T106B4	S	TO-202 (N.ISOL)
C106F41	T106B41	S	TO-202 (N.ISOL)
C106M	T106M1	S	TO-202 (N.ISOL)
C106M1	T106M1	S	TO-202 (N.ISOL)
C106M11	T106M11	S	TO-202 (N.ISOL)
C106M12	T106M12	S	TO-202 (N.ISOL)
C106M2	T106M2	S	TO-202 (N.ISOL)
C106M21	T106M21	S	TO-202 (N.ISOL)
C106M3	T106M3	S	TO-202 (N.ISOL)
C106M32	T106M32	S	TO-202 (N.ISOL)
C106M4	T106M4	S	TO-202 (N.ISOL)
C106M41	T106M41	S	TO-202 (N.ISOL)
C106Q	T106B1	S	TO-202 (N.ISOL)
C106Q1	T106B1	S	TO-202 (N.ISOL)
C106Q11	T106B11	S	TO-202 (N.ISOL)
C106Q12	T106B12	S	TO-202 (N.ISOL)
C106Q2	T106B2	S	TO-202 (N.ISOL)
C106Q21	T106B21	S	TO-202 (N.ISOL)
C106Q3	T106B3	S	TO-202 (N.ISOL)
C106Q32	T106B32	S	TO-202 (N.ISOL)
C106Q4	T106B4	S	TO-202 (N.ISOL)
C106Q41	T106B41	S	TO-202 (N.ISOL)
C106Y	T106B1	S	TO-202 (N.ISOL)
C106Y1	T106B1	S	TO-202 (N.ISOL)
C106Y11	T106B11	S	TO-202 (N.ISOL)
C106Y12	T106B12	S	TO-202 (N.ISOL)
C106Y2	T106B2	S	TO-202 (N.ISOL)
C106Y21	T106B21	S	TO-202 (N.ISOL)
C106Y3	T106B3	S	TO-202 (N.ISOL)
C106Y32	T106B32	S	TO-202 (N.ISOL)
C106Y4	T106B4	S	TO-202 (N.ISOL)
C106Y41	T106B41	S	TO-202 (N.ISOL)
C107A	T107B1	S	TO-202 (N.ISOL)
C107A1	T107B1	S	TO-202 (N.ISOL)
C107A11	T107B11	S	TO-202 (N.ISOL)
C107A12	T107B12	S	TO-202 (N.ISOL)
C107A2	T107B2	S	TO-202 (N.ISOL)
C107A21	T107B21	S	TO-202 (N.ISOL)
C107A3	T107B3	S	TO-202 (N.ISOL)
C107A32	T107B32	S	TO-202 (N.ISOL)
C107A4	T107B4	S	TO-202 (N.ISOL)
C107A41	T107B41	S	TO-202 (N.ISOL)
C107B	T107B1	S	TO-202 (N.ISOL)
C107B1	T107B1	S	TO-202 (N.ISOL)
C107B11	T107B11	S	TO-202 (N.ISOL)
C107B12	T107B12	S	TO-202 (N.ISOL)
C107B2	T107B2	S	TO-202 (N.ISOL)
C107B21	T107B21	S	TO-202 (N.ISOL)
C107B3	T107B3	S	TO-202 (N.ISOL)
C107B32	T107B32	S	TO-202 (N.ISOL)
C107B4	T107B4	S	TO-202 (N.ISOL)
C107B41	T107B41	S	TO-202 (N.ISOL)
C107C	T107D1	S	TO-202 (N.ISOL)
C107C1	T107D1	S	TO-202 (N.ISOL)
C107C11	T107D11	S	TO-202 (N.ISOL)
C107C12	T107D12	S	TO-202 (N.ISOL)
C107C2	T107D2	S	TO-202 (N.ISOL)
C107C21	T107D21	S	TO-202 (N.ISOL)
C107C3	T107D3	S	TO-202 (N.ISOL)
C107C32	T107D32	S	TO-202 (N.ISOL)
C107C4	T107D4	S	TO-202 (N.ISOL)
C107C41	T107D41	S	TO-202 (N.ISOL)
C107D	T107D1	S	TO-202 (N.ISOL)
C107D1	T107D1	S	TO-202 (N.ISOL)
C107D11	T107D11	S	TO-202 (N.ISOL)

Part Number	Teccor Device	Direct or Suggested Replacement	Teccor Package
C107D12	T107D12	S	TO-202 (N.ISOL)
C107D2	T107D2	S	TO-202 (N.ISOL)
C107D21	T107D21	S	TO-202 (N.ISOL)
C107D3	T107D3	S	TO-202 (N.ISOL)
C107D32	T107D32	S	TO-202 (N.ISOL)
C107D4	T107D4	S	TO-202 (N.ISOL)
C107D41	T107D41	S	TO-202 (N.ISOL)
C107E	T107M1	S	TO-202 (N.ISOL)
C107E1	T107M1	S	TO-202 (N.ISOL)
C107E11	T107M11	S	TO-202 (N.ISOL)
C107E12	T107M12	S	TO-202 (N.ISOL)
C107E2	T107M2	S	TO-202 (N.ISOL)
C107E21	T107M21	S	TO-202 (N.ISOL)
C107E3	T107M3	S	TO-202 (N.ISOL)
C107E32	T107M32	S	TO-202 (N.ISOL)
C107E4	T107M4	S	TO-202 (N.ISOL)
C107E41	T107M41	S	TO-202 (N.ISOL)
C107F	T107B1	S	TO-202 (N.ISOL)
C107F1	T107B1	S	TO-202 (N.ISOL)
C107F11	T107B11	S	TO-202 (N.ISOL)
C107F12	T107B12	S	TO-202 (N.ISOL)
C107F2	T107B2	S	TO-202 (N.ISOL)
C107F21	T107B21	S	TO-202 (N.ISOL)
C107F3	T107B3	S	TO-202 (N.ISOL)
C107F32	T107B32	S	TO-202 (N.ISOL)
C107F4	T107B4	S	TO-202 (N.ISOL)
C107F41	T107B41	S	TO-202 (N.ISOL)
C107M	T107M1	S	TO-202 (N.ISOL)
C107M1	T107M1	S	TO-202 (N.ISOL)
C107M11	T107M11	S	TO-202 (N.ISOL)
C107M12	T107M12	S	TO-202 (N.ISOL)
C107M2	T107M2	S	TO-202 (N.ISOL)
C107M21	T107M21	S	TO-202 (N.ISOL)
C107M3	T107M3	S	TO-202 (N.ISOL)
C107M32	T107M32	S	TO-202 (N.ISOL)
C107M41	T107M41	S	TO-202 (N.ISOL)
C107Q	T107B1	S	TO-202 (N.ISOL)
C107Q1	T107B1	S	TO-202 (N.ISOL)
C107Q11	T107B11	S	TO-202 (N.ISOL)
C107Q12	T107B12	S	TO-202 (N.ISOL)
C107Q2	T107B2	S	TO-202 (N.ISOL)
C107Q21	T107B21	S	TO-202 (N.ISOL)
C107Q3	T107B3	S	TO-202 (N.ISOL)
C107Q32	T107B32	S	TO-202 (N.ISOL)
C107Q4	T107B4	S	TO-202 (N.ISOL)
C107Q41	T107B41	S	TO-202 (N.ISOL)
C107Y	T107B1	S	TO-202 (N.ISOL)
C107Y1	T107B1	S	TO-202 (N.ISOL)
C107Y11	T107B11	S	TO-202 (N.ISOL)
C107Y12	T107B12	S	TO-202 (N.ISOL)
C107Y2	T107B2	S	TO-202 (N.ISOL)
C107Y21	T107B21	S	TO-202 (N.ISOL)
C107Y3	T107B3	S	TO-202 (N.ISOL)
C107Y32	T107B32	S	TO-202 (N.ISOL)
C107Y4	T107B4	S	TO-202 (N.ISOL)
C107Y41	T107B41	S	TO-202 (N.ISOL)
C108A	S2006FS21	S	TO-202 (N.ISOL)
C108A1	S2006FS21	S	TO-202 (N.ISOL)
C108A11	S2006FS211	S	TO-202 (N.ISOL)
C108A12	S2006FS212	S	TO-202 (N.ISOL)
C108A2	S2006FS22	S	TO-202 (N.ISOL)
C108A21	S2006FS221	S	TO-202 (N.ISOL)
C108A3	S2006FS23	S	TO-202 (N.ISOL)
C108A32	S2006FS232	S	TO-202 (N.ISOL)
C108A4	S2006FS24	S	TO-202 (N.ISOL)
C108A41	S2006FS241	S	TO-202 (N.ISOL)
C108B	S2006FS21	S	TO-202 (N.ISOL)
C108B1	S2006FS21	S	TO-202 (N.ISOL)
C108B11	S2006FS211	S	TO-202 (N.ISOL)
C108B12	S2006FS212	S	TO-202 (N.ISOL)

Part Number	Teccor Device	Direct or Suggested Replacement	Teccor Package
C108B2	S2006FS22	S	TO-202 (N.ISOL)
C108B21	S2006FS221	S	TO-202 (N.ISOL)
C108B3	S2006FS23	S	TO-202 (N.ISOL)
C108B32	S2006FS232	S	TO-202 (N.ISOL)
C108B4	S2006FS24	S	TO-202 (N.ISOL)
C108B41	S2006FS241	S	TO-202 (N.ISOL)
C108C	S4006FS21	S	TO-202 (N.ISOL)
C108C1	S4006FS21	S	TO-202 (N.ISOL)
C108C11	S4006FS211	S	TO-202 (N.ISOL)
C108C12	S4006FS212	S	TO-202 (N.ISOL)
C108C2	S4006FS22	S	TO-202 (N.ISOL)
C108C21	S4006FS221	S	TO-202 (N.ISOL)
C108C3	S4006FS23	S	TO-202 (N.ISOL)
C108C32	S4006FS232	S	TO-202 (N.ISOL)
C108C4	S4006FS24	S	TO-202 (N.ISOL)
C108C41	S4006FS241	S	TO-202 (N.ISOL)
C108D	S4006FS21	S	TO-202 (N.ISOL)
C108D1	S4006FS21	S	TO-202 (N.ISOL)
C108D11	S4006FS211	S	TO-202 (N.ISOL)
C108D12	S4006FS212	S	TO-202 (N.ISOL)
C108D2	S4006FS22	S	TO-202 (N.ISOL)
C108D21	S4006FS221	S	TO-202 (N.ISOL)
C108D3	S4006FS23	S	TO-202 (N.ISOL)
C108D32	S4006FS232	S	TO-202 (N.ISOL)
C108D4	S4006FS24	S	TO-202 (N.ISOL)
C108D41	S4006FS241	S	TO-202 (N.ISOL)
C108E	S6006FS21	S	TO-202 (N.ISOL)
C108E1	S6006FS21	S	TO-202 (N.ISOL)
C108E11	S6006FS211	S	TO-202 (N.ISOL)
C108E12	S6006FS212	S	TO-202 (N.ISOL)
C108E2	S6006FS22	S	TO-202 (N.ISOL)
C108E21	S6006FS221	S	TO-202 (N.ISOL)
C108E3	S6006FS23	S	TO-202 (N.ISOL)
C108E32	S6006FS232	S	TO-202 (N.ISOL)
C108E4	S6006FS24	S	TO-202 (N.ISOL)
C108E41	S6006FS241	S	TO-202 (N.ISOL)
C108F	S2006FS21	S	TO-202 (N.ISOL)
C108F1	S2006FS21	S	TO-202 (N.ISOL)
C108F11	S2006FS211	S	TO-202 (N.ISOL)
C108F12	S2006FS212	S	TO-202 (N.ISOL)
C108F2	S2006FS22	S	TO-202 (N.ISOL)
C108F21	S2006FS221	S	TO-202 (N.ISOL)
C108F3	S2006FS23	S	TO-202 (N.ISOL)
C108F32	S2006FS232	S	TO-202 (N.ISOL)
C108F4	S2006FS24	S	TO-202 (N.ISOL)
C108F41	S2006FS241	S	TO-202 (N.ISOL)
C108M	S6006FS21	S	TO-202 (N.ISOL)
C108M1	S6006FS21	S	TO-202 (N.ISOL)
C108M11	S6006FS211	S	TO-202 (N.ISOL)
C108M12	S6006FS212	S	TO-202 (N.ISOL)
C108M2	S6006FS22	S	TO-202 (N.ISOL)
C108M21	S6006FS221	S	TO-202 (N.ISOL)
C108M3	S6006FS23	S	TO-202 (N.ISOL)
C108M32	S6006FS232	S	TO-202 (N.ISOL)
C108M4	S6006FS24	S	TO-202 (N.ISOL)
C108M41	S6006FS241	S	TO-202 (N.ISOL)
C108Q	S2006FS21	S	TO-202 (N.ISOL)
C108Q1	S2006FS21	S	TO-202 (N.ISOL)
C108Q11	S2006FS211	S	TO-202 (N.ISOL)
C108Q12	S2006FS212	S	TO-202 (N.ISOL)
C108Q2	S2006FS22	S	TO-202 (N.ISOL)
C108Q21	S2006FS221	S	TO-202 (N.ISOL)
C108Q3	S2006FS23	S	TO-202 (N.ISOL)
C108Q32	S2006FS232	S	TO-202 (N.ISOL)
C108Q4	S2006FS24	S	TO-202 (N.ISOL)
C108Q41	S2006FS241	S	TO-202 (N.ISOL)
C108Y	S2006FS21	S	TO-202 (N.ISOL)
C108Y1	S2006FS21	S	TO-202 (N.ISOL)
C108Y11	S2006FS211	S	TO-202 (N.ISOL)
C108Y12	S2006FS212	S	TO-202 (N.ISOL)

Part Number	Teccor Device	Direct or Suggested Replacement	Teccor Package
C108Y2	S2006FS22	S	TO-202 (N.ISOL)
C108Y21	S2006FS221	S	TO-202 (N.ISOL)
C108Y3	S2006FS23	S	TO-202 (N.ISOL)
C108Y32	S2006FS232	S	TO-202 (N.ISOL)
C108Y4	S2006FS24	S	TO-202 (N.ISOL)
C108Y41	S2006FS241	S	TO-202 (N.ISOL)
C116A1	S2008F1	S	TO-202 (N.ISOL)
C116B1	S2008F1	S	TO-202 (N.ISOL)
C116C1	S4008F1	S	TO-202 (N.ISOL)
C116D1	S4008F1	S	TO-202 (N.ISOL)
C116E1	S6008F1	S	TO-202 (N.ISOL)
C116F1	S2008F1	S	TO-202 (N.ISOL)
C116M1	S6008F1	S	TO-202 (N.ISOL)
C122A	S2008R	S	TO-220 (N.ISOL)
C122B	S2008R	S	TO-220 (N.ISOL)
C122C	S4008R	S	TO-220 (N.ISOL)
C122D	S4008R	S	TO-220 (N.ISOL)
C122E	S6008R	S	TO-220 (N.ISOL)
C122F	S2008R	S	TO-220 (N.ISOL)
C122M	S6008R	S	TO-220 (N.ISOL)
C122N	S8008R	S	TO-220 (N.ISOL)
C122S	S8008R	S	TO-220 (N.ISOL)
C123A	S2008L	S	TO-220 (ISOL)
C123B	S2008L	S	TO-220 (ISOL)
C123C	S4008L	S	TO-220 (ISOL)
C123D	S4008L	S	TO-220 (ISOL)
C123E	S6008L	S	TO-220 (ISOL)
C123F	S2008L	S	TO-220 (ISOL)
C123M	S6008L	S	TO-220 (ISOL)
C126A	S2012R	S	TO-220 (N.ISOL)
C126B	S2012R	S	TO-220 (N.ISOL)
C126C	S4012R	S	TO-220 (N.ISOL)
C126D	S4012R	S	TO-220 (N.ISOL)
C126E	S6012R	S	TO-220 (N.ISOL)
C126F	S2012R	S	TO-220 (N.ISOL)
C126M	S6012R	S	TO-220 (N.ISOL)
C127A	S2016R	D	TO-220 (N.ISOL)
C127B	S2016R	D	TO-220 (N.ISOL)
C127D	S4016R	D	TO-220 (N.ISOL)
C127E	S6016R	D	TO-220 (N.ISOL)
C127F	S2016R	D	TO-220 (N.ISOL)
C127M	S6016R	D	TO-220 (N.ISOL)
C203A	EC103B	S	TO-92 (ISOL)
C203B	EC103B	S	TO-92 (ISOL)
C203C	EC103D	S	TO-92 (ISOL)
C203D	EC103D	S	TO-92 (ISOL)
C203Y	EC103B	S	TO-92 (ISOL)
C203YY	EC103B	S	TO-92 (ISOL)
C205A	EC103B	D	TO-92 (ISOL)
C205B	EC103B	D	TO-92 (ISOL)
C205C	EC103D	D	TO-92 (ISOL)
C205D	EC103D	D	TO-92 (ISOL)
C205Y	EC103B	D	TO-92 (ISOL)
C205YY	EC103B	D	TO-92 (ISOL)
D30	HT32	D	DO-35 (ISOL)
D40	HT40	D	DO-35 (ISOL)
DB3	HT32	S	DO-35 (ISOL)
DB4	HT40	D	DO-35 (ISOL)
DC34	HT32	S	DO-35 (ISOL)
DC38	HT40	S	DO-35 (ISOL)
DC42	HT40	S	DO-35 (ISOL)
DO201YR	HT5761	D	DO-35 (ISOL)
HI03SC	L2004F31	S	TO-202 (N.ISOL)
HI03SD	L2004F51	S	TO-202 (N.ISOL)
HI03SG	L2004F61	S	TO-202 (N.ISOL)
HI03SH	L2004F81	S	TO-202 (N.ISOL)
HI03SS	L2004F31	S	TO-202 (N.ISOL)
HI13SC	L2004F31	S	TO-202 (N.ISOL)
HI13SD	L2004F51	S	TO-202 (N.ISOL)
HI13SG	L2004F61	S	TO-202 (N.ISOL)

Part Number	Teccor Device	Direct or Suggested Replacement	Teccor Package
HI13SH	L2004F81	S	TO-202 (N.ISOL)
HI13SS	L2004F31	S	TO-202 (N.ISOL)
HI23SC	L2004F31	S	TO-202 (N.ISOL)
HI23SD	L2004F51	S	TO-202 (N.ISOL)
HI23SG	L2004F61	S	TO-202 (N.ISOL)
HI23SH	L2004F81	S	TO-202 (N.ISOL)
HI23SS	L2004F31	S	TO-202 (N.ISOL)
HI33SC	L4004F31	S	TO-202 (N.ISOL)
HI33SD	L4004F51	S	TO-202 (N.ISOL)
HI33SG	L4004F61	S	TO-202 (N.ISOL)
HI33SH	L4004F81	S	TO-202 (N.ISOL)
HI33SS	L4004F31	S	TO-202 (N.ISOL)
HI43SC	L4004F31	S	TO-202 (N.ISOL)
HI43SD	L4004F51	S	TO-202 (N.ISOL)
HI43SG	L4004F61	S	TO-202 (N.ISOL)
HI43SH	L4004F81	S	TO-202 (N.ISOL)
HI43SS	L4004F31	S	TO-202 (N.ISOL)
HI63SC	L6004F31	S	TO-202 (N.ISOL)
HI63SD	L6004F51	S	TO-202 (N.ISOL)
HI63SG	L6004F61	S	TO-202 (N.ISOL)
HI63SH	L6004F81	S	TO-202 (N.ISOL)
HI63SS	L6004F31	S	TO-202 (N.ISOL)
HT06	Q2006F41	S	TO-202 (N.ISOL)
HT16	Q2006F41	S	TO-202 (N.ISOL)
HT26	Q2006F41	S	TO-202 (N.ISOL)
HT36	Q4006F41	S	TO-202 (N.ISOL)
HT46	Q4006F41	S	TO-202 (N.ISOL)
HT66	Q6006F41	S	TO-202 (N.ISOL)
ID100	EC103B	S	TO-92 (ISOL)
ID101	EC103B	S	TO-92 (ISOL)
ID102	EC103B	S	TO-92 (ISOL)
ID103	EC103B	S	TO-92 (ISOL)
ID104	EC103B	S	TO-92 (ISOL)
ID105	EC103D	S	TO-92 (ISOL)
ID106	EC103D	S	TO-92 (ISOL)
IP100	2N5064	D	TO-92 (ISOL)
IP101	2N5064	D	TO-92 (ISOL)
IP102	2N5064	D	TO-92 (ISOL)
IP103	2N5064	D	TO-92 (ISOL)
IP104	2N5064	D	TO-92 (ISOL)
IP105	EC103D	D	TO-92 (ISOL)
IP106	EC103D	D	TO-92 (ISOL)
IS010	S2010L	D	TO-220 (ISOL)
IS010X	S2010L	D	TO-220 (ISOL)
IS020	S2020L	S	TO-220 (ISOL)
IS020X	S2020L	D	TO-220 (ISOL)
IS08	S2008L	D	TO-220 (ISOL)
IS08X	S2008L	D	TO-220 (ISOL)
IS110	S2010L	D	TO-220 (ISOL)
IS110X	S2010L	D	TO-220 (ISOL)
IS120	S2020L	S	TO-220 (ISOL)
IS120X	S2020L	D	TO-220 (ISOL)
IS18	S2008L	D	TO-220 (ISOL)
IS18X	S2008L	D	TO-220 (ISOL)
IS210	S2010L	D	TO-220 (ISOL)
IS210X	S2010L	D	TO-220 (ISOL)
IS220	S2020L	S	TO-220 (ISOL)
IS220X	S2020L	D	TO-220 (ISOL)
IS28	S2008L	D	TO-220 (ISOL)
IS28X	S2008L	D	TO-220 (ISOL)
IS310	S4010L	D	TO-220 (ISOL)
IS310X	S4010L	D	TO-220 (ISOL)
IS320	S4020L	S	TO-220 (ISOL)
IS320X	S4020L	D	TO-220 (ISOL)
IS38	S4008L	D	TO-220 (ISOL)
IS38X	S4008L	D	TO-220 (ISOL)
IS410	S4010L	D	TO-220 (ISOL)
IS410X	S4010L	D	TO-220 (ISOL)
IS420	S4020L	S	TO-220 (ISOL)
IS420X	S4020L	D	TO-220 (ISOL)

Part Number	Teccor Device	Direct or Suggested Replacement	Teccor Package
IS48	S4008L	D	TO-220 (ISOL)
IS48X	S4008L	D	TO-220 (ISOL)
IS510	S6010L	D	TO-220 (ISOL)
IS510X	S6010L	D	TO-220 (ISOL)
IS520	S6020L	S	TO-220 (ISOL)
IS520X	S6020L	D	TO-220 (ISOL)
IS58	S6008L	D	TO-220 (ISOL)
IS58X	S6008L	D	TO-220 (ISOL)
IS610	S6010L	D	TO-220 (ISOL)
IS610X	S6010L	D	TO-220 (ISOL)
IS620	S6020L	S	TO-220 (ISOL)
IS620X	S6020L	D	TO-220 (ISOL)
IS68	S6008L	D	TO-220 (ISOL)
IS68X	S6008L	D	TO-220 (ISOL)
IT010	Q2010L5	D	TO-220 (ISOL)
IT010A	Q2010L5	D	TO-220 (ISOL)
IT010B	Q2010L5	D	TO-220 (ISOL)
IT010HA	Q2010L5	S	TO-220 (ISOL)
IT010HX	Q2010L5	S	TO-220 (ISOL)
IT015	Q2015L5	D	TO-220 (ISOL)
IT015A	Q2015L5	D	TO-220 (ISOL)
IT015B	Q2015L5	D	TO-220 (ISOL)
IT015HA	Q2015L5	S	TO-220 (ISOL)
IT015HX	Q2015L5	S	TO-220 (ISOL)
IT06	Q2006L4	D	TO-220 (ISOL)
IT08	Q2008L4	D	TO-220 (ISOL)
IT08A	Q2008L4	D	TO-220 (ISOL)
IT08B	Q2008L4	D	TO-220 (ISOL)
IT08HA	Q2008L4	D	TO-220 (ISOL)
IT08HX	Q2008L4	S	TO-220 (ISOL)
IT110	Q2010L5	D	TO-220 (ISOL)
IT110A	Q2010L5	D	TO-220 (ISOL)
IT110B	Q2010L5	D	TO-220 (ISOL)
IT110HA	Q2010L5	S	TO-220 (ISOL)
IT110HX	Q2010L5	S	TO-220 (ISOL)
IT115	Q2015L5	D	TO-220 (ISOL)
IT115A	Q2015L5	D	TO-220 (ISOL)
IT115B	Q2015L5	D	TO-220 (ISOL)
IT115HA	Q2015L5	S	TO-220 (ISOL)
IT115HX	Q2015L5	S	TO-220 (ISOL)
IT16	Q2006L4	D	TO-220 (ISOL)
IT18	Q2008L4	D	TO-220 (ISOL)
IT18A	Q2008L4	D	TO-220 (ISOL)
IT18B	Q2008L4	D	TO-220 (ISOL)
IT18HA	Q2008L4	D	TO-220 (ISOL)
IT18HX	Q2008L4	S	TO-220 (ISOL)
IT210	Q2010L5	D	TO-220 (ISOL)
IT210A	Q2010L5	D	TO-220 (ISOL)
IT210B	Q2010L5	D	TO-220 (ISOL)
IT210HA	Q2010L5	S	TO-220 (ISOL)
IT210HX	Q2010L5	S	TO-220 (ISOL)
IT215	Q2015L5	D	TO-220 (ISOL)
IT215A	Q2015L5	D	TO-220 (ISOL)
IT215B	Q2015L5	D	TO-220 (ISOL)
IT215HA	Q2015L5	S	TO-220 (ISOL)
IT215HX	Q2015L5	S	TO-220 (ISOL)
IT26	Q2006L4	D	TO-220 (ISOL)
IT28	Q2008L4	D	TO-220 (ISOL)
IT28A	Q2008L4	D	TO-220 (ISOL)
IT28B	Q2008L4	D	TO-220 (ISOL)
IT28HA	Q2008L4	D	TO-220 (ISOL)
IT28HX	Q2008L4	S	TO-220 (ISOL)
IT310	Q4010L5	D	TO-220 (ISOL)
IT310A	Q4010L5	D	TO-220 (ISOL)
IT310B	Q4010L5	D	TO-220 (ISOL)
IT310HA	Q4010L5	S	TO-220 (ISOL)
IT310HX	Q4010L5	S	TO-220 (ISOL)
IT315	Q4015L5	D	TO-220 (ISOL)
IT315A	Q4015L5	D	TO-220 (ISOL)
IT315B	Q4015L5	D	TO-220 (ISOL)

Part Number	Teccor Device	Direct or Suggested Replacement	Teccor Package
IT315HA	Q4015L5	S	TO-220 (ISOL)
IT315HX	Q4015L5	S	TO-220 (ISOL)
IT36	Q4006L4	D	TO-220 (ISOL)
IT38	Q4008L4	D	TO-220 (ISOL)
IT38A	Q4008L4	D	TO-220 (ISOL)
IT38B	Q4008L4	D	TO-220 (ISOL)
IT38HA	Q4008L4	D	TO-220 (ISOL)
IT38HX	Q4008L4	S	TO-220 (ISOL)
IT410	Q4010L5	D	TO-220 (ISOL)
IT410A	Q4010L5	D	TO-220 (ISOL)
IT410B	Q4010L5	D	TO-220 (ISOL)
IT410HA	Q4010L5	S	TO-220 (ISOL)
IT410HX	Q4010L5	S	TO-220 (ISOL)
IT415	Q4015L5	D	TO-220 (ISOL)
IT415A	Q4015L5	D	TO-220 (ISOL)
IT415B	Q4015L5	D	TO-220 (ISOL)
IT415HA	Q4015L5	S	TO-220 (ISOL)
IT415HX	Q4015L5	S	TO-220 (ISOL)
IT46	Q4006L4	D	TO-220 (ISOL)
IT48	Q4008L4	D	TO-220 (ISOL)
IT48A	Q4008L4	D	TO-220 (ISOL)
IT48B	Q4008L4	D	TO-220 (ISOL)
IT48HA	Q4008L4	D	TO-220 (ISOL)
IT48HX	Q4008L4	S	TO-220 (ISOL)
IT510	Q6010L5	D	TO-220 (ISOL)
IT510A	Q6010L5	D	TO-220 (ISOL)
IT510B	Q6010L5	D	TO-220 (ISOL)
IT510HA	Q6010L5	S	TO-220 (ISOL)
IT510HX	Q6010L5	S	TO-220 (ISOL)
IT515	Q6015L5	D	TO-220 (ISOL)
IT515A	Q6015L5	D	TO-220 (ISOL)
IT515B	Q6015L5	D	TO-220 (ISOL)
IT515HA	Q6015L5	S	TO-220 (ISOL)
IT515HX	Q6015L5	S	TO-220 (ISOL)
IT56	Q6006L4	D	TO-220 (ISOL)
IT58	Q6008L4	D	TO-220 (ISOL)
IT58A	Q6008L4	D	TO-220 (ISOL)
IT58B	Q6008L4	D	TO-220 (ISOL)
IT58HA	Q6008L4	D	TO-220 (ISOL)
IT58HX	Q6008L4	S	TO-220 (ISOL)
IT610	Q6010L5	D	TO-220 (ISOL)
IT610A	Q6010L5	D	TO-220 (ISOL)
IT610B	Q6010L5	D	TO-220 (ISOL)
IT610HA	Q6010L5	S	TO-220 (ISOL)
IT610HX	Q6010L5	S	TO-220 (ISOL)
IT615	Q6015L5	D	TO-220 (ISOL)
IT615A	Q6015L5	D	TO-220 (ISOL)
IT615B	Q6015L5	D	TO-220 (ISOL)
IT615HA	Q6015L5	S	TO-220 (ISOL)
IT615HX	Q6015L5	S	TO-220 (ISOL)
IT66	Q6006L5	D	TO-220 (ISOL)
IT68	Q6008L5	D	TO-220 (ISOL)
IT68A	Q6008L5	D	TO-220 (ISOL)
IT68B	Q6008L5	D	TO-220 (ISOL)
IT68HA	Q6008L5	S	TO-220 (ISOL)
IT68HX	Q6008L5	S	TO-220 (ISOL)
K1V10	K1050G	S	DO-15X
K1V11	K1100G	S	DO-15X
K1V12	K1200G	S	DO-15X
K1V14	K1300G	S	DO-15X
K1V16	K1500G	S	DO-15X
K1V18	K1500G	S	DO-15X
K1V22	K2200G	S	DO-15X
K1V24	K2400G	S	DO-15X
K1V26	K2500G	S	DO-15X
K1VA10	K1050E70	S	TO-92 (ISOL)
K1VA11	K1100E70	S	TO-92 (ISOL)
K1VA12	K1200E70	S	TO-92 (ISOL)
K1VA14	K1300E70	S	TO-92 (ISOL)
K1VA16	K1500E70	S	TO-92 (ISOL)

Part Number	Teccor Device	Direct or Suggested Replacement	Teccor Package
L2004L7	L2004L6	D	TO-220 (ISOL)
L2004L9	L2004L8	D	TO-220 (ISOL)
L2006L7	L2006L6	D	TO-220 (ISOL)
L2006L9	L2006L8	D	TO-220 (ISOL)
L2008L7	L2008L6	D	TO-220 (ISOL)
L2008L9	L2008L8	D	TO-220 (ISOL)
L201E7	L201E6	D	TO-92 (ISOL)
L201E9	L201E8	D	TO-92 (ISOL)
L4004L7	L4004L6	D	TO-220 (ISOL)
L4004L9	L4004L8	D	TO-220 (ISOL)
L4006L7	L4006L6	D	TO-220 (ISOL)
L4006L9	L4006L8	D	TO-220 (ISOL)
L4008L7	L4008L6	D	TO-220 (ISOL)
L4008L9	L4008L8	D	TO-220 (ISOL)
L401E7	L401E6	D	TO-92 (ISOL)
L401E9	L401E8	D	TO-92 (ISOL)
L6004L7	L6004L6	D	TO-220 (ISOL)
L6004L9	L6004L8	D	TO-220 (ISOL)
L6006L7	L6006L6	D	TO-220 (ISOL)
L6006L9	L6006L8	D	TO-220 (ISOL)
L6008L7	L6008L6	D	TO-220 (ISOL)
L6008L9	L6008L8	D	TO-220 (ISOL)
L601E7	L601E6	D	TO-92 (ISOL)
L601E9	L601E8	D	TO-92 (ISOL)
MAC08BT1	L2X5	S	SOT-223/COMPAK
MAC08DT1	L4X5	S	SOT-223/COMPAK
MAC08MT1	L6X5	S	SOT-223/COMPAK
MAC12D	Q4015R5	S	TO-220 (N.ISOL)
MAC12HCD	Q4012RH5	S	TO-220 (N.ISOL)
MAC12HCM	Q6012RH5	S	TO-220 (N.ISOL)
MAC12HCN	Q8012RH5	S	TO-220 (N.ISOL)
MAC12M	Q6015R5	S	TO-220 (N.ISOL)
MAC12N	Q8015R5	S	TO-220 (N.ISOL)
MAC15-10	Q8015R5	D	TO-220 (N.ISOL)
MAC15-10FP	Q8015L5	D	TO-220 (ISOL)
MAC15-4	Q2015R5	D	TO-220 (N.ISOL)
MAC15-4FP	Q2015L5	D	TO-220 (ISOL)
MAC15-5	Q4015R5	D	TO-220 (N.ISOL)
MAC15-6	Q4015R5	D	TO-220 (N.ISOL)
MAC15-6FP	Q4015L5	D	TO-220 (ISOL)
MAC15-7	Q6015R5	D	TO-220 (N.ISOL)
MAC15-8	Q6015R5	D	TO-220 (N.ISOL)
MAC15-8FP	Q6015L5	D	TO-220 (ISOL)
MAC15-9	Q8015R5	D	TO-220 (N.ISOL)
MAC15A10	Q8015R5	S	TO-220 (N.ISOL)
MAC15A10FP	Q8015L5	S	TO-220 (ISOL)
MAC15A4	Q2015R5	S	TO-220 (N.ISOL)
MAC15A4FP	Q2015L5	S	TO-220 (ISOL)
MAC15A5	Q4015R5	S	TO-220 (N.ISOL)
MAC15A5FP	Q4015L5	S	TO-220 (ISOL)
MAC15A6	Q4015R5	S	TO-220 (N.ISOL)
MAC15A6FP	Q4015L5	S	TO-220 (ISOL)
MAC15A7	Q6015R5	S	TO-220 (N.ISOL)
MAC15A7FP	Q6015L5	S	TO-220 (ISOL)
MAC15A8	Q6015R5	S	TO-220 (N.ISOL)
MAC15A8FP	Q6015L5	S	TO-220 (ISOL)
MAC15A9	Q8015R5	S	TO-220 (N.ISOL)
MAC15A9FP	Q8015L5	S	TO-220 (ISOL)
MAC15M	Q6015R5	D	TO-220 (N.ISOL)
MAC15N	Q8015R5	D	TO-220 (N.ISOL)
MAC16-10	Q8015R6	D	TO-220 (N.ISOL)
MAC16-4	Q2015R6	D	TO-220 (N.ISOL)
MAC16-6	Q4015R6	D	TO-220 (N.ISOL)
MAC16-8	Q6015R6	D	TO-220 (N.ISOL)
MAC16CD	Q4015R6	S	TO-220 (N.ISOL)
MAC16CM	Q6015R6	S	TO-220 (N.ISOL)
MAC16CN	Q8015R6	S	TO-220 (N.ISOL)
MAC16D	Q4015R6	S	TO-220 (N.ISOL)
MAC16M	Q6015R6	S	TO-220 (N.ISOL)
MAC16N	Q8015R6	S	TO-220 (N.ISOL)

Part Number	Teccor Device	Direct or Suggested Replacement	Teccor Package
MAC20-10	Q8025P5	S	FASTPAK (ISOL)
MAC20-4	Q6025P5	S	FASTPAK (ISOL)
MAC20-5	Q6025P5	S	FASTPAK (ISOL)
MAC20-6	Q6025P5	S	FASTPAK (ISOL)
MAC20-7	Q6025P5	S	FASTPAK (ISOL)
MAC20-8	Q6025P5	S	FASTPAK (ISOL)
MAC20-9	Q8025P5	S	FASTPAK (ISOL)
MAC20A10	Q8025P5	S	FASTPAK (ISOL)
MAC20A4	Q6025P5	S	FASTPAK (ISOL)
MAC20A5	Q6025P5	S	FASTPAK (ISOL)
MAC20A6	Q6025P5	S	FASTPAK (ISOL)
MAC20A7	Q6025P5	S	FASTPAK (ISOL)
MAC20A8	Q6025P5	S	FASTPAK (ISOL)
MAC20A9	Q8025P5	S	FASTPAK (ISOL)
MAC210-10	Q8010R5	D	TO-220 (N.ISOL)
MAC210-10FP	Q8010L5	D	TO-220 (ISOL)
MAC210-4	Q2010R5	D	TO-220 (N.ISOL)
MAC210-4FP	Q2010L5	D	TO-220 (ISOL)
MAC210-5	Q4010R5	D	TO-220 (N.ISOL)
MAC210-6	Q4010R5	D	TO-220 (N.ISOL)
MAC210-6FP	Q4010L5	D	TO-220 (ISOL)
MAC210-7	Q6010R5	D	TO-220 (N.ISOL)
MAC210-8	Q6010R5	D	TO-220 (N.ISOL)
MAC210-8FP	Q6010L5	D	TO-220 (ISOL)
MAC210A10	Q8010R5	S	TO-220 (N.ISOL)
MAC210A10F	Q8010L5	S	TO-220 (ISOL)
MAC210A4	Q2010R5	S	TO-220 (N.ISOL)
MAC210A4FP	Q2010L5	S	TO-220 (ISOL)
MAC210A5	Q4010R5	S	TO-220 (N.ISOL)
MAC210A5FP	Q4010L5	S	TO-220 (ISOL)
MAC210A6	Q4010R5	S	TO-220 (N.ISOL)
MAC210A6FP	Q4010L5	S	TO-220 (ISOL)
MAC210A7	Q6010R5	S	TO-220 (N.ISOL)
MAC210A7FP	Q6010L5	S	TO-220 (ISOL)
MAC210A8	Q6010R5	S	TO-220 (N.ISOL)
MAC210A8FP	Q6010L5	S	TO-220 (ISOL)
MAC210A9	Q8010R5	S	TO-220 (N.ISOL)
MAC210A9FP	Q8010L5	S	TO-220 (ISOL)
MAC212-10	Q8012RH5	D	TO-220 (N.ISOL)
MAC212-10FP	Q8012LH5	D	TO-220 (ISOL)
MAC212-4	Q2012RH5	D	TO-220 (N.ISOL)
MAC212-4FP	Q2012LH5	D	TO-220 (ISOL)
MAC212-6	Q4012RH5	D	TO-220 (N.ISOL)
MAC212-6FP	Q4012LH5	D	TO-220 (ISOL)
MAC212-8	Q6012RH5	D	TO-220 (N.ISOL)
MAC212-8FP	Q6012LH5	D	TO-220 (ISOL)
MAC212A10	Q8012RH5	S	TO-220 (N.ISOL)
MAC212A10FP	Q8012LH5	S	TO-220 (ISOL)
MAC212A4	Q2015RH5	S	TO-220 (N.ISOL)
MAC212A4FP	Q2012LH5	S	TO-220 (ISOL)
MAC212A6	Q4012RH5	S	TO-220 (N.ISOL)
MAC212A6FP	Q4012LH5	S	TO-220 (ISOL)
MAC212A8	Q6012RH5	S	TO-220 (N.ISOL)
MAC212A8FP	Q6012LH5	S	TO-220 (ISOL)
MAC213-10	Q8012RH5	D	TO-220 (N.ISOL)
MAC213-4	Q2012RH5	D	TO-220 (N.ISOL)
MAC213-6	Q4012RH5	D	TO-220 (N.ISOL)
MAC213-8	Q6012RH5	D	TO-220 (N.ISOL)
MAC218-10	Q8008R5	D	TO-220 (N.ISOL)
MAC218-10FP	Q8008L5	D	TO-220 (ISOL)
MAC218-2	Q2008R5	D	TO-220 (N.ISOL)
MAC218-3	Q2008R5	D	TO-220 (N.ISOL)
MAC218-4	Q2008R5	D	TO-220 (N.ISOL)
MAC218-4FP	Q2008L5	D	TO-220 (ISOL)
MAC218-5	Q4008R4	D	TO-220 (N.ISOL)
MAC218-6	Q4008R4	D	TO-220 (N.ISOL)
MAC218-6FP	Q4008L5	D	TO-220 (ISOL)
MAC218-7	Q4008R4	D	TO-220 (N.ISOL)
MAC218-8	Q6008R5	D	TO-220 (N.ISOL)
MAC218-8FP	Q6008L5	S	TO-220 (ISOL)

Part Number	Teccor Device	Direct or Suggested Replacement	Teccor Package
MAC218-A10	Q8008R5	S	TO-220 (N.ISOL)
MAC218-A10FP	Q8008L5	S	TO-220 (ISOL)
MAC218-A2	Q2008R4	S	TO-220 (N.ISOL)
MAC218-A3	Q2008R4	S	TO-220 (N.ISOL)
MAC218-A4	Q2008R4	S	TO-220 (N.ISOL)
MAC218-A4FP	Q2008L4	S	TO-220 (ISOL)
MAC218-A5	Q4008R4	S	TO-220 (N.ISOL)
MAC218-A6	Q4008R4	S	TO-220 (N.ISOL)
MAC218-A6FP	Q4008L4	S	TO-220 (ISOL)
MAC218-A7	Q5008R4	S	TO-220 (N.ISOL)
MAC218-A8	Q6008R5	S	TO-220 (N.ISOL)
MAC218-A8FP	Q6008L5	S	TO-220 (ISOL)
MAC219-10	Q8008R5	D	TO-220 (N.ISOL)
MAC219-4	Q2008R4	D	TO-220 (N.ISOL)
MAC219-6	Q4008R4	D	TO-220 (N.ISOL)
MAC219-8	Q6008R5	D	TO-220 (N.ISOL)
MAC220-2	Q2008R4	D	TO-220 (N.ISOL)
MAC220-3	Q2008R4	D	TO-220 (N.ISOL)
MAC220-5	Q4008R4	D	TO-220 (N.ISOL)
MAC220-7	Q6008R4	D	TO-220 (N.ISOL)
MAC220-9	Q8008R5	D	TO-220 (N.ISOL)
MAC221-2	Q2008R4	D	TO-220 (N.ISOL)
MAC221-3	Q2008R4	D	TO-220 (N.ISOL)
MAC221-5	Q4008R4	D	TO-220 (N.ISOL)
MAC221-7	Q6008R4	D	TO-220 (N.ISOL)
MAC221-9	Q8008R5	D	TO-220 (N.ISOL)
MAC222-1	Q2008R4	D	TO-220 (N.ISOL)
MAC222-10	Q8008R5	D	TO-220 (N.ISOL)
MAC222-2	Q2008R4	D	TO-220 (N.ISOL)
MAC222-3	Q2008R4	D	TO-220 (N.ISOL)
MAC222-4	Q2008R4	D	TO-220 (N.ISOL)
MAC222-5	Q4008R4	D	TO-220 (N.ISOL)
MAC222-6	Q4008R4	D	TO-220 (N.ISOL)
MAC222-7	Q6008R4	D	TO-220 (N.ISOL)
MAC222-8	Q6008R5	D	TO-220 (N.ISOL)
MAC222-9	Q8008R5	D	TO-220 (N.ISOL)
MAC222A1	Q2008R4	S	TO-220 (N.ISOL)
MAC222A10	Q8008R5	S	TO-220 (N.ISOL)
MAC222A2	Q2008R4	S	TO-220 (N.ISOL)
MAC222A3	Q2008R4	S	TO-220 (N.ISOL)
MAC222A4	Q2008R4	S	TO-220 (N.ISOL)
MAC222A5	Q4008R4	S	TO-220 (N.ISOL)
MAC222A6	Q4008R4	S	TO-220 (N.ISOL)
MAC222A7	Q6008R4	S	TO-220 (N.ISOL)
MAC222A8	Q6008R5	S	TO-220 (N.ISOL)
MAC222A9	Q8008R5	S	TO-220 (N.ISOL)
MAC223-10	Q8025R5	S	TO-220 (N.ISOL)
MAC223-10FP	Q8025L6	S	TO-220 (ISOL)
MAC223-3	Q2025R5	S	TO-220 (N.ISOL)
MAC223-4	Q2025R5	S	TO-220 (N.ISOL)
MAC223-4FP	Q2025L6	S	TO-220 (ISOL)
MAC223-5	Q4025R5	S	TO-220 (N.ISOL)
MAC223-6	Q4025R5	S	TO-220 (N.ISOL)
MAC223-6FP	Q4025L6	S	TO-220 (ISOL)
MAC223-7	Q6025R5	S	TO-220 (N.ISOL)
MAC223-8	Q6025R5	S	TO-220 (N.ISOL)
MAC223-8FP	Q6025L6	S	TO-220 (ISOL)
MAC223-9	Q8025R5	S	TO-220 (N.ISOL)
MAC223A10	Q8025R5	S	TO-220 (N.ISOL)
MAC223A10FP	Q8025L6	S	TO-220 (ISOL)
MAC223A3	Q4025R5	S	TO-220 (N.ISOL)
MAC223A4	Q2025R5	S	TO-220 (N.ISOL)
MAC223A4FP	Q2025L6	S	TO-220 (ISOL)
MAC223A5	Q4025R5	S	TO-220 (N.ISOL)
MAC223A5FP	Q4025L6	S	TO-220 (ISOL)
MAC223A6	Q4025R5	S	TO-220 (N.ISOL)
MAC223A6FP	Q4025L6	S	TO-220 (ISOL)
MAC223A7	Q6025R5	S	TO-220 (N.ISOL)
MAC223A7FP	Q6025L6	S	TO-220 (ISOL)
MAC223A8	Q6025R5	S	TO-220 (N.ISOL)

Part Number	Teccor Device	Direct or Suggested Replacement	Teccor Package
MAC223A8FP	Q6025L6	S	TO-220 (ISOL)
MAC223A9	Q8025R5	S	TO-220 (N.ISOL)
MAC223A9FP	Q8025L6	S	TO-220 (ISOL)
MAC224-10	Q8040K7	S	TO-218 (ISOL)
MAC224-4	Q2040K7	S	TO-218 (ISOL)
MAC224-5	Q4040K7	S	TO-218 (ISOL)
MAC224-6	Q4040K7	S	TO-218 (ISOL)
MAC224-7	Q6040K7	S	TO-218 (ISOL)
MAC224-8	Q6040K7	S	TO-218 (ISOL)
MAC224A10	Q8040K7	S	TO-218 (ISOL)
MAC224A4	Q2040K7	S	TO-218 (ISOL)
MAC224A5	Q4040K7	S	TO-218 (ISOL)
MAC224A6	Q4040K7	S	TO-218 (ISOL)
MAC224A7	Q6040K7	S	TO-218 (ISOL)
MAC224A8	Q6040K7	S	TO-218 (ISOL)
MAC224A9	Q8040K7	S	TO-218 (ISOL)
MAC228-2	L2008L6	S	TO-220 (ISOL)
MAC228-3	L2008L6	S	TO-220 (ISOL)
MAC228-4	L2008L6	S	TO-220 (ISOL)
MAC228-4FP	L2008L6	D	TO-220 (ISOL)
MAC228-5	L4008L6	S	TO-220 (ISOL)
MAC228-6	L4008L6	S	TO-220 (ISOL)
MAC228-6FP	L4008L6	D	TO-220 (ISOL)
MAC228-7	L6008L6	S	TO-220 (ISOL)
MAC228-8	L6008L6	S	TO-220 (ISOL)
MAC228-8FP	L6008L6	D	TO-220 (ISOL)
MAC228A2	L2008L6	S	TO-220 (ISOL)
MAC228A3	L2008L6	S	TO-220 (ISOL)
MAC228A4	L2008L6	S	TO-220 (ISOL)
MAC228A4FP	L2008L6	S	TO-220 (ISOL)
MAC228A5	L4008L6	S	TO-220 (ISOL)
MAC228A6	L4008L6	S	TO-220 (ISOL)
MAC228A6FP	L4008L6	S	TO-220 (ISOL)
MAC228A7	L6008L6	S	TO-220 (ISOL)
MAC228A8	L6008L6	S	TO-220 (ISOL)
MAC228A8FP	L6008L6	S	TO-220 (ISOL)
MAC229-4	L2008L6	S	TO-220 (ISOL)
MAC229-4FP	L2008L6	D	TO-220 (ISOL)
MAC229-6	L4008L6	S	TO-220 (ISOL)
MAC229-6FP	L4008L6	D	TO-220 (ISOL)
MAC229-8	L6008L6	S	TO-220 (ISOL)
MAC229-8FP	L6008L6	D	TO-220 (ISOL)
MAC229A4	L2008L6	S	TO-220 (ISOL)
MAC229A4FP	L2008L6	S	TO-220 (ISOL)
MAC229A6	L4008L6	S	TO-220 (ISOL)
MAC229A6FP	L4008L6	S	TO-220 (ISOL)
MAC229A8	L6008L6	S	TO-220 (ISOL)
MAC229A8FP	L6008L6	S	TO-220 (ISOL)
MAC229A8FP	L6008L6	S	TO-220 (ISOL)
MAC25-10	Q8025P5	S	FASTPAK (ISOL)
MAC25-4	Q6025P5	S	FASTPAK (ISOL)
MAC25-5	Q6025P5	S	FASTPAK (ISOL)
MAC25-6	Q6025P5	S	FASTPAK (ISOL)
MAC25-7	Q6025P5	S	FASTPAK (ISOL)
MAC25-8	Q6025P5	S	FASTPAK (ISOL)
MAC25-9	Q8025P5	S	FASTPAK (ISOL)
MAC25A10	Q8025P5	S	FASTPAK (ISOL)
MAC25A4	Q6025P5	S	FASTPAK (ISOL)
MAC25A5	Q6025P5	S	FASTPAK (ISOL)
MAC25A6	Q6025P5	S	FASTPAK (ISOL)
MAC25A7	Q6025P5	S	FASTPAK (ISOL)
MAC25A8	Q6025P5	S	FASTPAK (ISOL)
MAC25A9	Q8025P5	S	FASTPAK (ISOL)
MAC3010-15	Q2015R5	S	TO-220 (N.ISOL)
MAC3010-25	Q2025R5	S	TO-220 (N.ISOL)
MAC3010-4	L2004F31	S	TO-202 (N.ISOL)
MAC3010-8	Q2008R4	D	TO-220 (N.ISOL)
MAC3020-15	Q4015R5	S	TO-220 (N.ISOL)
MAC3020-25	Q4025R5	S	TO-220 (N.ISOL)
MAC3020-4	L4004F31	S	TO-202 (N.ISOL)

Part Number	Teccor Device	Direct or Suggested Replacement	Teccor Package
MAC3020-8	Q4008R4	D	TO-220 (N.ISOL)
MAC3030-15	Q2015R5	S	TO-220 (N.ISOL)
MAC3030-25	Q2025R5	S	TO-220 (N.ISOL)
MAC3030-4	L4004F41	S	TO-202 (N.ISOL)
MAC3030-8	Q2008R4	D	TO-220 (N.ISOL)
MAC3040-15	Q4015R5	S	TO-220 (N.ISOL)
MAC3040-25	Q4025R5	S	TO-220 (N.ISOL)
MAC3040-4	L4004F41	S	TO-202 (N.ISOL)
MAC3040-8	Q4008R4	D	TO-220 (N.ISOL)
MAC320-10	Q8025R5	S	TO-220 (N.ISOL)
MAC320-10FP	Q8025L6	S	TO-220 (ISOL)
MAC320-4	Q2025R5	S	TO-220 (N.ISOL)
MAC320-4FP	Q2025L6	S	TO-220 (ISOL)
MAC320-6	Q4025R5	S	TO-220 (N.ISOL)
MAC320-6FP	Q4025L6	S	TO-220 (ISOL)
MAC320-8	Q6025R5	S	TO-220 (N.ISOL)
MAC320-8FP	Q6025L6	S	TO-220 (ISOL)
MAC320A10	Q8025R5	S	TO-220 (N.ISOL)
MAC320A4	Q2025R5	S	TO-220 (N.ISOL)
MAC320A6	Q4025R5	S	TO-220 (N.ISOL)
MAC320A8	Q6025R5	S	TO-220 (N.ISOL)
MAC321-10	Q8025R5	D	TO-220 (N.ISOL)
MAC321-4	Q2025R5	D	TO-220 (N.ISOL)
MAC321-6	Q4025R5	D	TO-220 (N.ISOL)
MAC321-8	Q6025R5	D	TO-220 (N.ISOL)
MAC4DCM	Q6006DH4	S	TO-252 (SMT)
MAC4DCM1	Q6006VH4	S	TO-251 (N.ISOL)
MAC4DCN	Q8006DH4	S	TO-252 (SMT)
MAC4DCN1	Q8006VH4	S	TO-251 (N.ISOL)
MAC4DHM	L6004D6	S	TO-252 (SMT)
MAC4DHM1	L6004V6	S	TO-251 (N.ISOL)
MAC4DLM	L6004D5	S	TO-252 (SMT)
MAC4DLM1	L6004V5	S	TO-251 (N.ISOL)
MAC4DSM	Q6006DH3	S	TO-252 (SMT)
MAC4DSM1	Q6006VH3	S	TO-251 (N.ISOL)
MAC4DSN	Q8006DH3	S	TO-252 (SMT)
MAC4DSN1	Q8006VH3	S	TO-251 (N.ISOL)
MAC50-4	Q6035P5	S	FASTPAK (ISOL)
MAC50-5	Q6035P5	S	FASTPAK (ISOL)
MAC50-6	Q6035P5	S	FASTPAK (ISOL)
MAC50-7	Q6035P5	S	FASTPAK (ISOL)
MAC50-8	Q6035P5	S	FASTPAK (ISOL)
MAC50-9	Q8035P5	S	FASTPAK (ISOL)
MAC50A4	Q6035P5	S	FASTPAK (ISOL)
MAC50A5	Q6035P5	S	FASTPAK (ISOL)
MAC50A6	Q6035P5	S	FASTPAK (ISOL)
MAC50A7	Q6035P5	S	FASTPAK (ISOL)
MAC50A8	Q6035P5	S	FASTPAK (ISOL)
MAC50A9	Q8035P5	S	FASTPAK (ISOL)
MAC515-10	Q8025P5	S	FASTPAK (ISOL)
MAC515-4	Q6025P5	S	FASTPAK (ISOL)
MAC515-5	Q6025P5	S	FASTPAK (ISOL)
MAC515-6	Q6025P5	S	FASTPAK (ISOL)
MAC515-7	Q6025P5	S	FASTPAK (ISOL)
MAC515-8	Q6025P5	S	FASTPAK (ISOL)
MAC515-9	Q8025P5	S	FASTPAK (ISOL)
MAC515A10	Q8025P5	S	FASTPAK (ISOL)
MAC515A4	Q6025P5	S	FASTPAK (ISOL)
MAC515A5	Q6025P5	S	FASTPAK (ISOL)
MAC515A6	Q6025P5	S	FASTPAK (ISOL)
MAC515A7	Q6025P5	S	FASTPAK (ISOL)
MAC515A8	Q6025P5	S	FASTPAK (ISOL)
MAC515A9	Q8025P5	S	FASTPAK (ISOL)
MAC525-10	Q8025P5	S	FASTPAK (ISOL)
MAC525-4	Q6025P5	S	FASTPAK (ISOL)
MAC525-5	Q6025P5	S	FASTPAK (ISOL)
MAC525-6	Q6025P5	S	FASTPAK (ISOL)
MAC525-7	Q6025P5	S	FASTPAK (ISOL)
MAC525-8	Q6025P5	S	FASTPAK (ISOL)
MAC525-9	Q8025P5	S	FASTPAK (ISOL)

Part Number	Teccor Device	Direct or Suggested Replacement	Teccor Package
MAC525A10	Q8025P5	S	FASTPAK (ISOL)
MAC525A4	Q6025P5	S	FASTPAK (ISOL)
MAC525A5	Q6025P5	S	FASTPAK (ISOL)
MAC525A6	Q6025P5	S	FASTPAK (ISOL)
MAC525A7	Q6025P5	S	FASTPAK (ISOL)
MAC525A8	Q6025P5	S	FASTPAK (ISOL)
MAC525A9	Q8025P5	S	FASTPAK (ISOL)
MAC625-4	Q6025P5	S	FASTPAK (ISOL)
MAC625-6	Q6025P5	S	FASTPAK (ISOL)
MAC625-8	Q6025P5	S	FASTPAK (ISOL)
MAC635-4	Q6035P5	S	FASTPAK (ISOL)
MAC635-6	Q6035P5	S	FASTPAK (ISOL)
MAC635-8	Q6035P5	S	FASTPAK (ISOL)
MAC8D	Q4008RH4	D	TO-220 (N.ISOL)
MAC8M	Q6008RH4	D	TO-220 (N.ISOL)
MAC8N	Q8008RH4	D	TO-220 (N.ISOL)
MAC91-1	Q2X8E3	D	TO-92 (ISOL)
MAC91-2	Q2X8E3	D	TO-92 (ISOL)
MAC91-3	Q2X8E3	D	TO-92 (ISOL)
MAC91-4	Q2X8E3	D	TO-92 (ISOL)
MAC91-5	Q4X8E3	D	TO-92 (ISOL)
MAC91-6	Q4X8E3	D	TO-92 (ISOL)
MAC91-7	Q5X8E3	D	TO-92 (ISOL)
MAC91-8	Q6X8E3	D	TO-92 (ISOL)
MAC91A1	L2X8E6	D	TO-92 (ISOL)
MAC91A2	L2X8E6	D	TO-92 (ISOL)
MAC91A3	L2X8E6	D	TO-92 (ISOL)
MAC91A4	L2X8E6	D	TO-92 (ISOL)
MAC91A5	L4X8E6	D	TO-92 (ISOL)
MAC91A6	L4X8E6	D	TO-92 (ISOL)
MAC91A7	L6X8E6	D	TO-92 (ISOL)
MAC91A8	L6X8E6	D	TO-92 (ISOL)
MAC92-1	L2X8E5	D	TO-92 (ISOL)
MAC92-2	L2X8E5	D	TO-92 (ISOL)
MAC92-3	L2X8E5	D	TO-92 (ISOL)
MAC92-4	L2X8E5	D	TO-92 (ISOL)
MAC92-5	L4X8E5	D	TO-92 (ISOL)
MAC92-6	L4X8E5	D	TO-92 (ISOL)
MAC92-7	L6X8E5	D	TO-92 (ISOL)
MAC92-8	L6X8E5	D	TO-92 (ISOL)
MAC92A1	L2X8E5	D	TO-92 (ISOL)
MAC92A2	L2X8E5	D	TO-92 (ISOL)
MAC92A3	L2X8E5	D	TO-92 (ISOL)
MAC92A4	L2X8E5	D	TO-92 (ISOL)
MAC92A5	L4X8E5	D	TO-92 (ISOL)
MAC92A6	L4X8E5	D	TO-92 (ISOL)
MAC92A7	L6X8E5	D	TO-92 (ISOL)
MAC92A8	L6X8E5	D	TO-92 (ISOL)
MAC93-1	L2X8E3	D	TO-92 (ISOL)
MAC93-2	L2X8E3	D	TO-92 (ISOL)
MAC93-3	L2X8E3	D	TO-92 (ISOL)
MAC93-4	L2X8E3	D	TO-92 (ISOL)
MAC93-5	L4X8E3	D	TO-92 (ISOL)
MAC93-6	L4X8E3	D	TO-92 (ISOL)
MAC93-7	L6X8E3	D	TO-92 (ISOL)
MAC93-8	L6X8E3	D	TO-92 (ISOL)
MAC93A1	Q2X8E3	D	TO-92 (ISOL)
MAC93A2	Q2X8E3	D	TO-92 (ISOL)
MAC93A3	Q2X8E3	D	TO-92 (ISOL)
MAC93A4	Q2X8E3	D	TO-92 (ISOL)
MAC93A5	L4X8E3	D	TO-92 (ISOL)
MAC93A6	L4X8E3	D	TO-92 (ISOL)
MAC93A7	L6X8E3	D	TO-92 (ISOL)
MAC93A8	L6X8E3	D	TO-92 (ISOL)
MAC94-1	Q2X8E3	D	TO-92 (ISOL)
MAC94-2	Q2X8E3	D	TO-92 (ISOL)
MAC94-3	Q2X8E3	D	TO-92 (ISOL)
MAC94-4	Q2X8E3	D	TO-92 (ISOL)
MAC94-5	Q4X8E3	D	TO-92 (ISOL)
MAC94-6	Q4X8E3	D	TO-92 (ISOL)

Part Number	Teccor Device	Direct or Suggested Replacement	Teccor Package
MAC94-7	Q6X8E3	D	TO-92 (ISOL)
MAC94-8	Q6X8E3	D	TO-92 (ISOL)
MAC94A1	L2X8E6	D	TO-92 (ISOL)
MAC94A2	L2X8E6	D	TO-92 (ISOL)
MAC94A3	L2X8E6	D	TO-92 (ISOL)
MAC94A4	L2X8E6	D	TO-92 (ISOL)
MAC94A5	L4X8E6	D	TO-92 (ISOL)
MAC94A6	L4X8E6	D	TO-92 (ISOL)
MAC94A7	L6X8E6	D	TO-92 (ISOL)
MAC94A8	L6X8E6	D	TO-92 (ISOL)
MAC95-1	L2X8E5	D	TO-92 (ISOL)
MAC95-2	L2X8E5	D	TO-92 (ISOL)
MAC95-3	L2X8E5	D	TO-92 (ISOL)
MAC95-4	L2X8E5	D	TO-92 (ISOL)
MAC95-5	L4X8E5	D	TO-92 (ISOL)
MAC95-6	L4X8E5	D	TO-92 (ISOL)
MAC95-7	L6X8E5	D	TO-92 (ISOL)
MAC95-8	L6X8E5	D	TO-92 (ISOL)
MAC95A1	L2X8E5	D	TO-92 (ISOL)
MAC95A2	L2X8E5	D	TO-92 (ISOL)
MAC95A3	L2X8E5	D	TO-92 (ISOL)
MAC95A4	L2X8E5	D	TO-92 (ISOL)
MAC95A5	L4X8E5	D	TO-92 (ISOL)
MAC95A6	L4X8E5	D	TO-92 (ISOL)
MAC95A7	L6X8E5	D	TO-92 (ISOL)
MAC95A8	L6X8E5	D	TO-92 (ISOL)
MAC96-1	L2X8E3	D	TO-92 (ISOL)
MAC96-2	L2X8E3	D	TO-92 (ISOL)
MAC96-3	L2X8E3	D	TO-92 (ISOL)
MAC96-4	L2X8E3	D	TO-92 (ISOL)
MAC96-5	L4X8E3	D	TO-92 (ISOL)
MAC96-6	L4X8E3	D	TO-92 (ISOL)
MAC96-7	L6X8E3	D	TO-92 (ISOL)
MAC96-8	L6X8E3	D	TO-92 (ISOL)
MAC96A1	L2X8E3	D	TO-92 (ISOL)
MAC96A2	L2X8E3	D	TO-92 (ISOL)
MAC96A3	L2X8E3	D	TO-92 (ISOL)
MAC96A4	L2X8E3	D	TO-92 (ISOL)
MAC96A5	L4X8E3	D	TO-92 (ISOL)
MAC96A6	L4X8E3	D	TO-92 (ISOL)
MAC96A7	L6X8E3	D	TO-92 (ISOL)
MAC96A8	L6X8E3	D	TO-92 (ISOL)
MAC97-2	L2X8E6	D	TO-92 (ISOL)
MAC97-3	L2X8E6	D	TO-92 (ISOL)
MAC97-4	L2X8E6	D	TO-92 (ISOL)
MAC97-5	L4X8E6	D	TO-92 (ISOL)
MAC97-6	L4X8E6	D	TO-92 (ISOL)
MAC97-7	L6X8E6	D	TO-92 (ISOL)
MAC97-8	L6X8E6	D	TO-92 (ISOL)
MAC97A2	L2X8E5	D	TO-92 (ISOL)
MAC97A3	L2X8E5	D	TO-92 (ISOL)
MAC97A4	L2X8E5	D	TO-92 (ISOL)
MAC97A5	L4X8E5	D	TO-92 (ISOL)
MAC97A6	L4X8E5	D	TO-92 (ISOL)
MAC97A7	L6X8E5	D	TO-92 (ISOL)
MAC97A8	L6X8E5	D	TO-92 (ISOL)
MAC97B2	L2X8E3	D	TO-92 (ISOL)
MAC97B3	L2X8E3	D	TO-92 (ISOL)
MAC97B4	L2X8E3	D	TO-92 (ISOL)
MAC97B5	L4X8E3	D	TO-92 (ISOL)
MAC97B6	L4X8E3	D	TO-92 (ISOL)
MAC97B7	L6X8E3	D	TO-92 (ISOL)
MAC97B8	L6X8E3	D	TO-92 (ISOL)
MAC9D	Q4008RH4	S	TO-220 (N.ISOL)
MAC9M	Q6008RH4	S	TO-220 (N.ISOL)
MAC9N	Q8008RH4	S	TO-220 (N.ISOL)
MCR08BT1	S2S	S	SOT-223 / COMPAK
MCR08DT1	S4S	S	SOT-223 / COMPAK
MCR08MT1	S6S	S	SOT-223 / COMPAK
MCR100-3	EC103B	D	TO-92 (ISOL)

Part Number	Teccor Device	Direct or Suggested Replacement	Teccor Package
MCR100-4	EC103B	D	TO-92 (ISOL)
MCR100-5	EC103D	D	TO-92 (ISOL)
MCR100-6	EC103D	D	TO-92 (ISOL)
MCR100-7	EC103M	D	TO-92 (ISOL)
MCR100-8	EC103M	D	TO-92 (ISOL)
MCR101	EC103B	D	TO-92 (ISOL)
MCR102	EC103B	D	TO-92 (ISOL)
MCR103	EC103B	D	TO-92 (ISOL)
MCR106-1	T106B1	D	TO-202 (N.ISOL)
MCR106-2	T106B1	D	TO-202 (N.ISOL)
MCR106-3	T106B1	D	TO-202 (N.ISOL)
MCR106-4	T106B1	D	TO-202 (N.ISOL)
MCR106-5	T106D1	D	TO-202 (N.ISOL)
MCR106-6	T106D1	D	TO-202 (N.ISOL)
MCR106-7	T106M1	D	TO-202 (N.ISOL)
MCR106-8	T106M1	D	TO-202 (N.ISOL)
MCR120	EC103B	D	TO-92 (ISOL)
MCR12DSM	S6010DS2	S	TO-252 (SMT)
MCR12DSM1	S6010VS2	S	TO-251 (N.ISOL)
MCR12M	Q6015R	S	TO-220 (N.ISOL)
MCR12N	Q8015R	S	TO-220 (N.ISOL)
MCR16D	Q4015R	S	TO-220 (N.ISOL)
MCR16M	Q6015R	S	TO-220 (N.ISOL)
MCR16N	Q8015R	S	TO-220 (N.ISOL)
MCR202	EC103B	S	TO-92 (ISOL)
MCR203	EC103B	S	TO-92 (ISOL)
MCR204	EC103B	S	TO-92 (ISOL)
MCR206	EC103B	S	TO-92 (ISOL)
MCR218-10FP	S8008L	D	TO-220 (ISOL)
MCR218-2	S2008R	D	TO-220 (N.ISOL)
MCR218-2FP	S2008L	D	TO-220 (ISOL)
MCR218-3	S2008R	D	TO-220 (N.ISOL)
MCR218-3FP	S2008L	D	TO-220 (ISOL)
MCR218-4	S2008R	D	TO-220 (N.ISOL)
MCR218-4FP	S2008L	D	TO-220 (ISOL)
MCR218-5	S4008R	D	TO-220 (N.ISOL)
MCR218-6	S4008R	D	TO-220 (N.ISOL)
MCR218-6FP	S4008L	D	TO-220 (ISOL)
MCR218-7	S6008R	D	TO-220 (N.ISOL)
MCR218-8	S6008R	D	TO-220 (N.ISOL)
MCR218-8FP	S6008L	D	TO-220 (ISOL)
MCR220-5	S4012R	D	TO-220 (N.ISOL)
MCR220-7	S6012R	D	TO-220 (N.ISOL)
MCR220-9	S8012R	D	TO-220 (N.ISOL)
MCR22-1	TCR22-4	S	TO-92 (ISOL)
MCR221-5	S4016R	D	TO-220 (N.ISOL)
MCR221-7	S6016R	D	TO-220 (N.ISOL)
MCR221-9	S8016R	D	TO-220 (N.ISOL)
MCR22-2	TCR22-4	D	TO-92 (ISOL)
MCR22-3	TCR22-4	D	TO-92 (ISOL)
MCR22-4	TCR22-4	D	TO-92 (ISOL)
MCR225-10FP	S8025L	S	TO-220 (ISOL)
MCR225-2FP	S2025L	S	TO-220 (ISOL)
MCR225-4FP	S2025L	S	TO-220 (ISOL)
MCR225-5	S4025R	S	TO-220 (N.ISOL)
MCR225-6FP	S4025L	S	TO-220 (ISOL)
MCR225-7	S6025R	S	TO-220 (N.ISOL)
MCR225-8FP	S6025L	S	TO-220 (ISOL)
MCR225-9	S8025R	S	TO-220 (N.ISOL)
MCR22-6	TCR22-6	D	TO-92 (ISOL)
MCR22-7	TCR22-8	D	TO-92 (ISOL)
MCR22-8	TCR22-8	D	TO-92 (ISOL)
MCR25D	S4025R	D	TO-220 (N.ISOL)
MCR25M	S6025R	D	TO-220 (N.ISOL)
MCR25N	S8025R	D	TO-220 (N.ISOL)
MCR264-10	S8040R	D	TO-220 (N.ISOL)
MCR264-2	S2040R	D	TO-220 (N.ISOL)
MCR264-3	S2040R	D	TO-220 (N.ISOL)
MCR264-4	S2040R	D	TO-220 (N.ISOL)
MCR264-6	S4040R	D	TO-220 (N.ISOL)

Part Number	Teccor Device	Direct or Suggested Replacement	Teccor Package
MCR264-8	S6040R	D	TO-220 (N.ISOL)
MCR265-10	S8055R	D	TO-220 (N.ISOL)
MCR265-2	S2055R	D	TO-220 (N.ISOL)
MCR265-3	S2055R	D	TO-220 (N.ISOL)
MCR265-4	S2055R	D	TO-220 (N.ISOL)
MCR265-6	S4055R	D	TO-220 (N.ISOL)
MCR265-8	S6055R	D	TO-220 (N.ISOL)
MCR3000-1	S2008R	S	TO-220 (N.ISOL)
MCR3000-10	S8008R	S	TO-220 (N.ISOL)
MCR3000-2	S2008R	S	TO-220 (N.ISOL)
MCR3000-3	S2008R	S	TO-220 (N.ISOL)
MCR3000-4	S2008R	S	TO-220 (N.ISOL)
MCR3000-5	S4008R	S	TO-220 (N.ISOL)
MCR3000-6	S4008R	S	TO-220 (N.ISOL)
MCR3000-7	S6008R	S	TO-220 (N.ISOL)
MCR3000-8	S6008R	S	TO-220 (N.ISOL)
MCR3000-9	S8008R	S	TO-220 (N.ISOL)
MCR310-1	S2010LS2	S	TO-220 (ISOL)
MCR310-2	S2010LS2	S	TO-220 (ISOL)
MCR310-3	S2010LS2	S	TO-220 (ISOL)
MCR310-4	S2010LS2	S	TO-220 (ISOL)
MCR310-5	S4010LS2	S	TO-220 (ISOL)
MCR310-6	S4010LS2	S	TO-220 (ISOL)
MCR310-7	S6010LS2	S	TO-220 (ISOL)
MCR310-8	S6010LS2	S	TO-220 (ISOL)
MCR506-1	S2006FS21	S	TO-202 (N.ISOL)
MCR506-2	S2006FS21	S	TO-202 (N.ISOL)
MCR506-3	S2006FS21	S	TO-202 (N.ISOL)
MCR506-4	S2006FS21	S	TO-202 (N.ISOL)
MCR506-6	S4006FS21	S	TO-202 (N.ISOL)
MCR506-8	S6006FS21	S	TO-202 (N.ISOL)
MCR525-1	S2035J	S	TO-218 (ISOL)
MCR525-2	S2035J	S	TO-218 (ISOL)
MCR525-3	S2035J	S	TO-218 (ISOL)
MCR525-6	S4035J	S	TO-218 (ISOL)
MCR68-1	S2012R	D	TO-220 (N.ISOL)
MCR68-2	S2012R	D	TO-220 (N.ISOL)
MCR68-3	S2012R	D	TO-220 (N.ISOL)
MCR68-6	S4012R	D	TO-220 (N.ISOL)
MCR69-1	S2025R	D	TO-220 (N.ISOL)
MCR69-2	S2025R	D	TO-220 (N.ISOL)
MCR69-3	S2025R	D	TO-220 (N.ISOL)
MCR69-6	S4025R	D	TO-220 (N.ISOL)
MCR704A	S2004DS2	S	TO-252 (SMT)
MCR704A1	S2004VS2	S	TO-251 (N.ISOL)
MCR706A	S4004DS2	S	TO-252 (SMT)
MCR706A1	S4004VS2	S	TO-251 (N.ISOL)
MCR708A	S6004DS2	S	TO-252 (SMT)
MCR708A1	S6004VS2	S	TO-251 (N.ISOL)
MCR716	S4004DS2	D	TO-252 (SMT)
MCR718	S6004DS2	D	TO-252 (SMT)
MCR72-1	S2008LS2	S	TO-220 (ISOL)
MCR72-2	S2008LS2	S	TO-220 (ISOL)
MCR72-3	S2008LS2	S	TO-220 (ISOL)
MCR72-4	S2008LS2	S	TO-220 (ISOL)
MCR72-5	S4008LS2	S	TO-220 (ISOL)
MCR72-6	S4008LS2	S	TO-220 (ISOL)
MCR72-7	S6008LS2	S	TO-220 (ISOL)
MCR72-8	S6008LS2	S	TO-220 (ISOL)
MCR8DCM	S6008D	D	TO-252 (SMT)
MCR8DCM1	S6008V	D	TO-251 (N.ISOL)
MCR8DCN	S8008D	D	TO-252 (SMT)
MCR8DCN1	S8008V	D	TO-251 (N.ISOL)
MCR8DSM	S6008DS2	D	TO-252 (SMT)
MCR8DSM1	S6008VS2	D	TO-251 (N.ISOL)
MCR8SD	S4008FS21	S	TO-202 (N.ISOL)
MCR8SM	S6008FS21	S	TO-202 (N.ISOL)
MK1V115	K1100G	S	DO-15X
MK1V125	K1200G	S	DO-15X
MK1V135	K1300G	S	DO-15X

Part Number	Teccor Device	Direct or Suggested Replacement	Teccor Package
MK1V240	K2400G	S	DO-15X
MK1V260	K2500G	S	DO-15X
MK1V270	K2500G	S	DO-15X
MK1V280	K2500G	S	DO-15X
MKP1V120	K1200E70	S	TO-92 (ISOL)
MKP1V130	K1300E70	S	TO-92 (ISOL)
MKP1V240	K2400E70	S	TO-92 (ISOL)
MKP3V110	K1100G	S	DO-15X
MKP3V120	K1200G	S	DO-15X
MKP3V130	K1300G	S	DO-15X
MKP9V120	K1200E70	S	TO-92 (ISOL)
MKP9V130	K1300E70	S	TO-92 (ISOL)
MKP9V240	K2400E70	S	TO-92 (ISOL)
MKP9V260	K2500E70	S	TO-92 (ISOL)
MKP9V270	K2500E70	S	TO-92 (ISOL)
MN611A	K1050E70	S	TO-92 (ISOL)
P0100AA	EC103B1	D	TO-92 (ISOL)
P0100AB	EC103B1	S	TO-92 (ISOL)
P0100BA	EC103B1	D	TO-92 (ISOL)
P0100BB	EC103B1	S	TO-92 (ISOL)
P0100CA	EC103D1	D	TO-92 (ISOL)
P0100CB	EC103D1	S	TO-92 (ISOL)
P0100DA	EC103D1	D	TO-92 (ISOL)
P0100DB	EC103D1	S	TO-92 (ISOL)
P0101AA	EC103B1	D	TO-92 (ISOL)
P0101AB	EC103B1	S	TO-92 (ISOL)
P0101BA	EC103B1	D	TO-92 (ISOL)
P0101BB	EC103B1	S	TO-92 (ISOL)
P0101CA	EC103D1	D	TO-92 (ISOL)
P0101CB	EC103D1	S	TO-92 (ISOL)
P0101DA	EC103D1	D	TO-92 (ISOL)
P0101DB	EC103D1	S	TO-92 (ISOL)
P0102AA	EC103B	D	TO-92 (ISOL)
P0102AB	EC103B	S	TO-92 (ISOL)
P0102AD	EC103B78	S	TO-92 (ISOL)
P0102AN	S2S	S	SOT223/COMPAK
P0102BA	EC103B	D	TO-92 (ISOL)
P0102BB	EC103B	S	TO-92 (ISOL)
P0102BD	EC103B78	S	TO-92 (ISOL)
P0102BN	S2S	S	SOT223/COMPAK
P0102CA	EC103D	D	TO-92 (ISOL)
P0102CB	EC103D	S	TO-92 (ISOL)
P0102CD	EC103D78	S	TO-92 (ISOL)
P0102CN	S4S	S	SOT223/COMPAK
P0102DA	EC103D	D	TO-92 (ISOL)
P0102DB	EC103D	S	TO-92 (ISOL)
P0102DD	EC103D78	S	TO-92 (ISOL)
P0102DN	S4S	S	SOT223/COMPAK
P0103AA	EC103B	D	TO-92 (ISOL)
P0103AB	EC103B	S	TO-92 (ISOL)
P0103BA	EC103B	D	TO-92 (ISOL)
P0103BB	EC103B	S	TO-92 (ISOL)
P0103CA	EC103D	D	TO-92 (ISOL)
P0103CB	EC103D	S	TO-92 (ISOL)
P0103DA	EC103D	D	TO-92 (ISOL)
P0103DB	EC103D	S	TO-92 (ISOL)
P0104AA	EC103B2	D	TO-92 (ISOL)
P0104AB	EC103B2	S	TO-92 (ISOL)
P0104BA	EC103B2	D	TO-92 (ISOL)
P0104BB	EC103B2	S	TO-92 (ISOL)
P0104CA	EC103D2	D	TO-92 (ISOL)
P0104CB	EC103D2	S	TO-92 (ISOL)
P0104DA	EC103D2	D	TO-92 (ISOL)
P0104DB	EC103D2	S	TO-92 (ISOL)
P0105AA	EC103B2	S	TO-92 (ISOL)
P0105AB	EC103B2	S	TO-92 (ISOL)
P0105BA	EC103B2	S	TO-92 (ISOL)
P0105BB	EC103B2	D	TO-92 (ISOL)
P0105CA	EC103D2	S	TO-92 (ISOL)
P0105CB	EC103D2	S	TO-92 (ISOL)

Part Number	Teccor Device	Direct or Suggested Replacement	Teccor Package
P0105DA	EC103D2	S	TO-92 (ISOL)
P0105DB	EC103D2	S	TO-92 (ISOL)
P0110AA	EC103B1	S	TO-92 (ISOL)
P0110AB	EC103B1	S	TO-92 (ISOL)
P0110BA	EC103B1	S	TO-92 (ISOL)
P0110BB	EC103B2	S	TO-92 (ISOL)
P0110CA	EC103D2	S	TO-92 (ISOL)
P0110CB	EC103D1	S	TO-92 (ISOL)
P0110DA	EC103D1	S	TO-92 (ISOL)
P0110DB	EC103D1	S	TO-92 (ISOL)
P0111AN	S2S1	S	SOT223/COMPAK
P0111BN	S2S1	S	SOT223/COMPAK
P0111CN	S4S1	S	SOT223/COMPAK
P0111DN	S4S1	S	SOT223/COMPAK
PT20	D2015L	D	TO-220 (ISOL)
PT40	D4015L	D	TO-220 (ISOL)
PT60	D6015L	D	TO-220 (ISOL)
Q2015L9	Q2016LH6	D	TO-220 (ISOL)
Q2015R9	Q2016RH6	D	TO-220 (N.ISOL)
Q2025L9	Q2025L6	S	TO-220 (ISOL)
Q2025R9	Q2025R6	S	TO-220 (N.ISOL)
Q2040J9	Q2040J7	D	TO-218X (ISOL)
Q2040K9	Q2040K7	D	TO-218AC (ISOL)
Q4015L9	Q4016LH6	D	TO-220 (ISOL)
Q4015R9	Q4016RH6	D	TO-220 (N.ISOL)
Q4025L9	Q4025L6	S	TO-220 (ISOL)
Q4025R9	Q4025R6	S	TO-220 (N.ISOL)
Q4040J9	Q4040J7	D	TO-218X (ISOL)
Q4040K9	Q4040K7	D	TO-218AC (ISOL)
Q5015L9	Q6016LH6	D	TO-220 (ISOL)
Q5015R9	Q6016RH6	D	TO-220 (N.ISOL)
Q5025L9	Q6025L6	S	TO-220 (ISOL)
Q5025R9	Q6025R6	S	TO-220 (N.ISOL)
Q5040J9	Q6040J7	D	TO-218X (ISOL)
Q5040K9	Q6040K7	D	TO-218AC (ISOL)
Q6015L9	Q6016LH6	D	TO-220 (ISOL)
Q6015R9	Q6016RH6	D	TO-220 (N.ISOL)
Q6025L9	Q6025L6	S	TO-220 (ISOL)
Q6025R9	Q6025R6	S	TO-220 (N.ISOL)
Q6040J9	Q6040J7	D	TO-218X (ISOL)
Q6040K9	Q6040K7	D	TO-218AC (ISOL)
Q7015L9	Q8016LH6	D	TO-220 (ISOL)
Q7015R9	Q8016RH6	D	TO-220 (N.ISOL)
Q7025L9	Q8025L6	S	TO-220 (ISOL)
Q7025R9	Q8025R6	S	TO-220 (N.ISOL)
Q7040J9	Q8040J7	D	TO-218X (ISOL)
Q7040K9	Q8040K7	D	TO-218AC (ISOL)
Q8015L9	Q8016LH6	D	TO-220 (ISOL)
Q8015R9	Q8016RH6	D	TO-220 (N.ISOL)
Q8025L9	Q8025L6	S	TO-220 (ISOL)
Q8025R9	Q8025R6	S	TO-220 (N.ISOL)
Q8040J9	Q8040J7	D	TO-218X (ISOL)
Q8040K9	Q8040K7	D	TO-218AC (ISOL)
S0402BH	T106B1	S	TO-202 (N.ISOL)
S0402DH	T106D1	S	TO-202 (N.ISOL)
S0402MH	T106M1	S	TO-202 (N.ISOL)
S0405BH	S2006L	D	TO-220 (ISOL)
S0405DH	S4006L	D	TO-220 (ISOL)
S0405MH	S6006L	S	TO-220 (ISOL)
S0406BH	S2006L	S	TO-220 (ISOL)
S0406DH	S4006L	S	TO-220 (ISOL)
S0406MH	S6006L	S	TO-220 (ISOL)
S0406NH	S8006L	S	TO-220 (ISOL)
S0407BH	S2006L	S	TO-220 (ISOL)
S0407DH	S4006L	S	TO-220 (ISOL)
S0407MH	S6006L	S	TO-220 (ISOL)
S0410BH	S2006L	S	TO-220 (ISOL)
S0410DH	S4006L	S	TO-220 (ISOL)
S0410MH	S6006L	S	TO-220 (ISOL)
S0410NH	S8006L	S	TO-220 (ISOL)

Part Number	Teccor Device	Direct or Suggested Replacement	Teccor Package
S0417BH	S2006L	S	TO-220 (ISOL)
S0417DH	S4006L	S	TO-220 (ISOL)
S0417MH	S6006L	S	TO-220 (ISOL)
S0417NH	S8006L	S	TO-220 (ISOL)
S0602BH	S2006LS2	S	TO-220 (ISOL)
S0602DH	S4006LS2	S	TO-220 (ISOL)
S0602MH	S6006LS2	S	TO-220 (ISOL)
S0605BH	S2006L	S	TO-220 (ISOL)
S0605DH	S4006L	S	TO-220 (ISOL)
S0605MH	S6006L	S	TO-220 (ISOL)
S0606BH	S2006L	S	TO-220 (ISOL)
S0606DH	S4006L	S	TO-220 (ISOL)
S0606MH	S6006L	S	TO-220 (ISOL)
S0606NH	S8006L	S	TO-220 (ISOL)
S0607BH	S2006L	S	TO-220 (ISOL)
S0607DH	S4006L	S	TO-220 (ISOL)
S0607MH	S6006L	S	TO-220 (ISOL)
S0610BH	S2006L	S	TO-220 (ISOL)
S0610DH	S4006L	S	TO-220 (ISOL)
S0610MH	S6006L	S	TO-220 (ISOL)
S0610NH	S8006L	S	TO-220 (ISOL)
S0617BH	S2006L	S	TO-220 (ISOL)
S0617DH	S4006L	S	TO-220 (ISOL)
S0617MH	S6006L	S	TO-220 (ISOL)
S0617NH	S8006L	S	TO-220 (ISOL)
S0802BH	S2008LS2	S	TO-220 (ISOL)
S0802DH	S4008LS2	S	TO-220 (ISOL)
S0802MH	S6008LS2	S	TO-220 (ISOL)
S0805BH	S2006R	S	TO-220 (N.ISOL)
S0805DH	S4006R	S	TO-220 (N.ISOL)
S0805MH	S6008R	S	TO-220 (N.ISOL)
S0806BH	S2008R	S	TO-220 (N.ISOL)
S0806DH	S4008R	S	TO-220 (N.ISOL)
S0806MH	S6008R	S	TO-220 (N.ISOL)
S0806NH	S8008R	S	TO-220 (N.ISOL)
S0807BH	S2008R	S	TO-220 (N.ISOL)
S0807DH	S4008R	S	TO-220 (N.ISOL)
S0807MH	S6008R	S	TO-220 (N.ISOL)
S0807NH	S8008R	S	TO-220 (N.ISOL)
S0810BH	S2008R	S	TO-220 (N.ISOL)
S0810DH	S4008R	S	TO-220 (N.ISOL)
S0810MH	S6008R	S	TO-220 (N.ISOL)
S0810NH	S8008R	S	TO-220 (N.ISOL)
S0817BH	S2008R	S	TO-220 (N.ISOL)
S0817DH	S4008R	S	TO-220 (N.ISOL)
S0817MH	S6008R	S	TO-220 (N.ISOL)
S0817NH	S8008R	S	TO-220 (N.ISOL)
S1005BH	S2010R	S	TO-220 (N.ISOL)
S1005DH	S4010R	S	TO-220 (N.ISOL)
S1005MH	S6010R	S	TO-220 (N.ISOL)
S1006BH	S2010R	S	TO-220 (N.ISOL)
S1006DH	S4010R	S	TO-220 (N.ISOL)
S1006MH	S6010R	S	TO-220 (N.ISOL)
S1006NH	S8010R	S	TO-220 (N.ISOL)
S1007BH	S2010R	S	TO-220 (N.ISOL)
S1007DH	S4010R	S	TO-220 (N.ISOL)
S1007MH	S6010R	S	TO-220 (N.ISOL)
S1010BH	S2010R	S	TO-220 (N.ISOL)
S1010DH	S4010R	S	TO-220 (N.ISOL)
S1010MH	S6010R	S	TO-220 (N.ISOL)
S1010NH	S8010R	S	TO-220 (N.ISOL)
S1017BH	S2010R	S	TO-220 (N.ISOL)
S1017DH	S4010R	S	TO-220 (N.ISOL)
S1017MH	S6010R	S	TO-220 (N.ISOL)
S1017NH	S8010R	S	TO-220 (N.ISOL)
S106A1	T106B1	D	TO-202 (N.ISOL)
S106B1	T106B1	D	TO-202 (N.ISOL)
S106C1	T106D1	D	TO-202 (N.ISOL)
S106D1	T106D1	D	TO-202 (N.ISOL)
S106E1	T106M1	D	TO-202 (N.ISOL)

Part Number	Teccor Device	Direct or Suggested Replacement	Teccor Package
S106F1	T106B1	D	TO-202 (N.ISOL)
S106M1	T106M1	D	TO-202 (N.ISOL)
S106Y1	T106B1	D	TO-202 (N.ISOL)
S107A1	T107B1	D	TO-202 (N.ISOL)
S107B1	T107B1	D	TO-202 (N.ISOL)
S107C1	T107D1	D	TO-202 (N.ISOL)
S107D1	T107D1	D	TO-202 (N.ISOL)
S107E1	T107M1	D	TO-202 (N.ISOL)
S107F1	T107B1	D	TO-202 (N.ISOL)
S107M1	T107M1	D	TO-202 (N.ISOL)
S107Q1	T107B1	D	TO-202 (N.ISOL)
S107Y1	T107B1	D	TO-202 (N.ISOL)
S1205BH	S2012R	S	TO-220 (N.ISOL)
S1205DH	S4012R	S	TO-220 (N.ISOL)
S1205MH	S6012R	S	TO-220 (N.ISOL)
S1206BH	S2012R	S	TO-220 (N.ISOL)
S1206DH	S4012R	S	TO-220 (N.ISOL)
S1206MH	S6012R	S	TO-220 (N.ISOL)
S1206NH	S8012R	S	TO-220 (N.ISOL)
S1207BH	S2012R	S	TO-220 (N.ISOL)
S1207DH	S4012R	S	TO-220 (N.ISOL)
S1207MH	S6012R	S	TO-220 (N.ISOL)
S1210BH	S2012R	S	TO-220 (N.ISOL)
S1210DH	S4012R	S	TO-220 (N.ISOL)
S1210MH	S6012R	S	TO-220 (N.ISOL)
S1210NH	S8012R	S	TO-220 (N.ISOL)
S1217BH	S2012R	S	TO-220 (N.ISOL)
S1217DH	S4012R	S	TO-220 (N.ISOL)
S1217MH	S6012R	S	TO-220 (N.ISOL)
S1217NH	S8012R	S	TO-220 (N.ISOL)
S1610BH	S2016R	S	TO-220 (N.ISOL)
S1610DH	S4016R	S	TO-220 (N.ISOL)
S1610MH	S6016R	S	TO-220 (N.ISOL)
S1610NH	S8016R	S	TO-220 (N.ISOL)
S1612BH	S2016R	S	TO-220 (N.ISOL)
S1612DH	S4016R	S	TO-220 (N.ISOL)
S1612MH	S6016R	S	TO-220 (N.ISOL)
S1612NH	S8016R	S	TO-220 (N.ISOL)
S1616BH	S2016R	S	TO-220 (N.ISOL)
S1616DH	S4016R	S	TO-220 (N.ISOL)
S1616MH	S6016R	S	TO-220 (N.ISOL)
S1616NH	S8016R	S	TO-220 (N.ISOL)
S1A	EC103B	D	TO-92 (ISOL)
S1B	EC103B	D	TO-92 (ISOL)
S1D	EC103D	D	TO-92 (ISOL)
S1M	EC103M	D	TO-92 (ISOL)
S1Y	EC103B	S	TO-92 (ISOL)
S1YY	EC103B	D	TO-92 (ISOL)
S2060A	S2006LS2	S	TO-220 (ISOL)
S2060B	S2006LS2	S	TO-220 (ISOL)
S2060C	S4006LS2	S	TO-220 (ISOL)
S2060D	S4006LS2	S	TO-220 (ISOL)
S2060E	S6006LS2	S	TO-220 (ISOL)
S2060F	S2006LS2	S	TO-220 (ISOL)
S2060M	S6006LS2	S	TO-220 (ISOL)
S2060Y	S2006LS2	S	TO-220 (ISOL)
S2061A	S2006LS3	S	TO-220 (ISOL)
S2061B	S2006LS3	S	TO-220 (ISOL)
S2061C	S4006LS3	S	TO-220 (ISOL)
S2061D	S4006LS3	S	TO-220 (ISOL)
S2061E	S6006LS3	S	TO-220 (ISOL)
S2061F	S2006LS3	S	TO-220 (ISOL)
S2061Q	S2006LS3	S	TO-220 (ISOL)
S2061Y	S2006LS3	S	TO-220 (ISOL)
S2062A	S2006LS3	S	TO-220 (ISOL)
S2062B	S2006LS3	S	TO-220 (ISOL)
S2062C	S4006LS3	S	TO-220 (ISOL)
S2062D	S4006LS3	S	TO-220 (ISOL)
S2062E	S6006LS3	S	TO-220 (ISOL)
S2062F	S2006LS3	S	TO-220 (ISOL)

Part Number	Teccor Device	Direct or Suggested Replacement	Teccor Package
S2062M	S6006LS3	S	TO-220 (ISOL)
S2062Q	S2006LS3	S	TO-220 (ISOL)
S2062Y	S2006LS3	S	TO-220 (ISOL)
S2512BH	S2025R	S	TO-220 (N.ISOL)
S2512BK	S2035J	S	TO-218 (ISOL)
S2512DH	S4025R	S	TO-220 (N.ISOL)
S2512DK	S4035J	S	TO-218 (ISOL)
S2512MH	S6025R	S	TO-220 (N.ISOL)
S2512MK	S6035J	S	TO-218 (ISOL)
S2512NH	S8025R	S	TO-220 (N.ISOL)
S2512NK	S8035J	S	TO-218 (ISOL)
S2514BH	S2025R	S	TO-220 (N.ISOL)
S2514BK	S2035J	S	TO-218 (ISOL)
S2514DH	S4025R	S	TO-220 (N.ISOL)
S2514DK	S4035J	S	TO-218 (ISOL)
S2514MH	S6025R	S	TO-220 (N.ISOL)
S2514MK	S6035J	S	TO-218 (ISOL)
S2514NH	S8025R	S	TO-220 (N.ISOL)
S2514NK	S8035J	S	TO-218 (ISOL)
S2516BH	S2025R	S	TO-220 (N.ISOL)
S2516DH	S4025R	S	TO-220 (N.ISOL)
S2516MH	S6025R	S	TO-220 (N.ISOL)
S2516NH	S8025R	S	TO-220 (N.ISOL)
S2600B	S2006L	S	TO-220 (ISOL)
S2600D	S4006L	S	TO-220 (ISOL)
S2600M	S6006L	S	TO-220 (ISOL)
S2800A	S2010R	D	TO-220 (N.ISOL)
S2800B	S2010R	D	TO-220 (N.ISOL)
S2800C	S4010R	S	TO-220 (N.ISOL)
S2800D	S4010R	D	TO-220 (N.ISOL)
S2800E	S6010R	S	TO-220 (N.ISOL)
S2800F	S2010R	D	TO-220 (N.ISOL)
S2800M	S6010R	D	TO-220 (N.ISOL)
S2800N	S8010R	D	TO-220 (N.ISOL)
S3014NH	S8040R	S	TO-220 (N.ISOL)
S3016NH	S8040R	S	TO-220 (N.ISOL)
S4012BH	S2040R	S	TO-220 (N.ISOL)
S4012BK	S2035J	S	TO-218 (ISOL)
S4012DH	S4040R	S	TO-220 (N.ISOL)
S4012DK	S4035J	S	TO-218 (ISOL)
S4012MH	S6040R	S	TO-220 (N.ISOL)
S4012MK	S6035J	S	TO-218 (ISOL)
S4012NH	S8040R	S	TO-220 (N.ISOL)
S4012NK	S8035J	S	TO-218 (ISOL)
S4014BH	S2040R	S	TO-220 (N.ISOL)
S4014BK	S2035J	S	TO-218 (ISOL)
S4014DH	S4040R	S	TO-220 (N.ISOL)
S4014DK	S4035J	S	TO-218 (ISOL)
S4014MH	S6040R	S	TO-220 (N.ISOL)
S4014MK	S6035J	S	TO-218 (ISOL)
S4014NH	S8040R	S	TO-220 (N.ISOL)
S4014NK	S8065J	S	TO-218 (ISOL)
S4016BH	S2040R	S	TO-220 (N.ISOL)
S4016DH	S4040R	S	TO-220 (N.ISOL)
S4016MH	S6040R	S	TO-220 (N.ISOL)
S4016NH	S8040R	S	TO-220 (N.ISOL)
S4060A	S2010LS2	S	TO-220 (ISOL)
S4060B	S2010LS2	S	TO-220 (ISOL)
S4060C	S4010LS2	S	TO-220 (ISOL)
S4060D	S4010LS2	S	TO-220 (ISOL)
S4060F	S2010LS2	S	TO-220 (ISOL)
S4060U	S2010LS2	S	TO-220 (ISOL)
S5800B	S2008R	S	TO-220 (N.ISOL)
S5800C	S4008R	S	TO-220 (N.ISOL)
S5800D	S4008R	S	TO-220 (N.ISOL)
S5800E	S6008R	S	TO-220 (N.ISOL)
S5800M	S6008R	S	TO-220 (N.ISOL)
SC129B	Q2025R5	D	TO-220 (N.ISOL)
SC129D	Q4025R5	D	TO-220 (N.ISOL)
SC129E	Q6025R5	D	TO-220 (N.ISOL)

Part Number	Teccor Device	Direct or Suggested Replacement	Teccor Package
SC129M	Q6025R5	D	TO-220 (N.ISOL)
SC136A	Q2004F41	S	TO-202 (N.ISOL)
SC136B	Q2004F41	S	TO-202 (N.ISOL)
SC136C	Q4004F41	S	TO-202 (N.ISOL)
SC136D	Q4004F41	S	TO-202 (N.ISOL)
SC136E	Q5004F41	S	TO-202 (N.ISOL)
SC136M	Q6004F41	S	TO-202 (N.ISOL)
SC140B	Q2006L4	D	TO-220 (ISOL)
SC140D	Q4006L4	D	TO-220 (ISOL)
SC140E	Q6006L4	D	TO-220 (ISOL)
SC140M	Q6006L5	D	TO-220 (ISOL)
SC141A	Q2006R4	S	TO-220 (N.ISOL)
SC141B	Q2006R4	D	TO-220 (N.ISOL)
SC141C	Q4006R4	S	TO-220 (N.ISOL)
SC141D	Q4006R4	D	TO-220 (N.ISOL)
SC141E	Q6006R4	D	TO-220 (N.ISOL)
SC141M	Q6006R5	D	TO-220 (N.ISOL)
SC141N	Q8006R5	D	TO-220 (N.ISOL)
SC142B	Q2008L4	D	TO-220 (ISOL)
SC142D	Q4008L4	D	TO-220 (ISOL)
SC142E	Q6008L4	D	TO-220 (ISOL)
SC142M	Q6008L5	D	TO-220 (ISOL)
SC143B	Q2008R4	D	TO-220 (N.ISOL)
SC143D	Q4008R4	D	TO-220 (N.ISOL)
SC143E	Q6008R4	D	TO-220 (N.ISOL)
SC143M	Q6008R5	D	TO-220 (N.ISOL)
SC146B	Q2010R5	D	TO-220 (N.ISOL)
SC146D	Q4010R5	D	TO-220 (N.ISOL)
SC146E	Q6010R5	D	TO-220 (N.ISOL)
SC146M	Q6010R5	D	TO-220 (N.ISOL)
SC146N	Q8010R5	D	TO-220 (N.ISOL)
SC147B	Q2010L5	D	TO-220 (ISOL)
SC147D	Q4010L5	D	TO-220 (ISOL)
SC147E	Q6010L5	D	TO-220 (ISOL)
SC147M	Q6010L5	D	TO-220 (ISOL)
SC148B	Q2010L5	D	TO-220 (ISOL)
SC148D	Q4010L5	D	TO-220 (ISOL)
SC148E	Q6010L5	D	TO-220 (ISOL)
SC148M	Q6010L5	D	TO-220 (ISOL)
SC149B	Q2015R5	D	TO-220 (N.ISOL)
SC149D	Q4015R5	D	TO-220 (N.ISOL)
SC149E	Q6015R5	D	TO-220 (N.ISOL)
SC149M	Q6015R5	D	TO-220 (N.ISOL)
SC150B	Q2015L5	D	TO-220 (ISOL)
SC150D	Q4015L5	D	TO-220 (ISOL)
SC150E	Q6015L5	D	TO-220 (ISOL)
SC150M	Q6015L5	D	TO-220 (ISOL)
SC151B	Q2015R5	D	TO-220 (N.ISOL)
SC151D	Q4015R5	D	TO-220 (N.ISOL)
SC151E	Q6015R5	D	TO-220 (N.ISOL)
SC151M	Q6015R5	D	TO-220 (N.ISOL)
SC160B	Q6025P5	S	FASTPAK (ISOL)
SC160D	Q6025P5	S	FASTPAK (ISOL)
SC160E	Q6025P5	S	FASTPAK (ISOL)
SC160M	Q6025P5	S	FASTPAK (ISOL)
SC92A	Q201E3	D	TO-92 (ISOL)
SC92B	Q201E3	D	TO-92 (ISOL)
SC92D	Q401E3	D	TO-92 (ISOL)
SC92F	Q201E3	D	TO-92 (ISOL)
SF0R1A42	EC103B	S	TO-92 (ISOL)
SF0R1B42	EC103B	S	TO-92 (ISOL)
SF0R1D42	EC103B	S	TO-92 (ISOL)
SF0R1G42	EC103D	S	TO-92 (ISOL)
SF0R3B42	EC103B	S	TO-92 (ISOL)
SF0R3D42	EC103B	S	TO-92 (ISOL)
SF0R3G42	EC103D	S	TO-92 (ISOL)
SF0R3J42	EC103M	S	TO-92 (ISOL)
SF0R5B43	EC103B	S	TO-92 (ISOL)
SF0R5D43	EC103B	S	TO-92 (ISOL)
SF0R5G43	EC103D	S	TO-92 (ISOL)

Part Number	Teccor Device	Direct or Suggested Replacement	Teccor Package
SF0R5H43	EC103M	S	TO-92 (ISOL)
SF0R5J43	EC103M	S	TO-92 (ISOL)
SF10D41A	S2016R	S	TO-220 (N.ISOL)
SF10G41A	S4016R	S	TO-220 (N.ISOL)
SF10J41A	S6016R	S	TO-220 (N.ISOL)
SF1B12	TR22-4	S	TO-39/TO-92 (ISOL)
SF1D12	TR22-4	S	TO-39/TO-92 (ISOL)
SF1G12	TR22-6	S	TO-39/TO-92 (ISOL)
SF3B41	S2006F1	S	TO-202 (N.ISOL)
SF3B42	T106B1	S	TO-202 (N.ISOL)
SF3D41	S2006F1	S	TO-202 (N.ISOL)
SF3D42	T106B1	S	TO-202 (N.ISOL)
SF3D42C	T106B1	S	TO-202 (N.ISOL)
SF3G41	S4006F1	S	TO-202 (N.ISOL)
SF3G42	T106D1	S	TO-202 (N.ISOL)
SF3G42C	T106D1	S	TO-202 (N.ISOL)
SF3H42LC2	T106M2	S	TO-202 (N.ISOL)
SF3J41	S6006F1	S	TO-202 (N.ISOL)
SF3J42	T106M1	S	TO-202 (N.ISOL)
SF5B41	S2008R	S	TO-202 (N.ISOL)
SF5B42	S2008FS21	S	TO-202 (N.ISOL)
SF5D41	S2008R	S	TO-202 (N.ISOL)
SF5D41A	S2012R	S	TO-202 (N.ISOL)
SF5D42	S2008FS21	S	TO-202 (N.ISOL)
SF5G41	S4008R	S	TO-202 (N.ISOL)
SF5G41A	S6012R	S	TO-202 (N.ISOL)
SF5G42	S4008FS21	S	TO-202 (N.ISOL)
SF5J41	S6008R	S	TO-202 (N.ISOL)
SF5J41A	S6012R	S	TO-202 (N.ISOL)
SF5J42	S6008FS21	S	TO-202 (N.ISOL)
SF8B41	S2012R	S	TO-220 (N.ISOL)
SF8D41	S2012R	S	TO-220 (N.ISOL)
SF8D41A	S2012R	S	TO-220 (N.ISOL)
SF8G41	S4012R	S	TO-220 (N.ISOL)
SF8G41A	S4012R	S	TO-220 (N.ISOL)
SF8J41	S6012R	S	TO-220 (N.ISOL)
SF8J41A	S6012R	S	TO-220 (N.ISOL)
SM0R5B42	Q2X8E3	S	TO-92 (ISOL)
SM0R5D42	Q2X8E3	S	TO-92 (ISOL)
SM0R5G42	Q4X8E3	S	TO-92 (ISOL)
SM12D41	Q2012RH5	S	TO-220 (N.ISOL)
SM12G41	Q4012RH5	S	TO-220 (N.ISOL)
SM12J41	Q6012RH5	S	TO-220 (N.ISOL)
SM16DZ41	Q2025P5	S	FASTPAK (ISOL)
SM16G45	Q4016RH4	S	TO-220 (N.ISOL)
SM16G45A	Q4016RH3	S	TO-220 (N.ISOL)
SM16GZ41	Q4025P5	S	FASTPAK (ISOL)
SM16GZ47	Q4016LH4	S	TO-220 (ISOL)
SM16GZ47A	Q4016LH3	S	TO-220 (ISOL)
SM16J45	Q6016RH4	S	TO-220 (N.ISOL)
SM16J45A	Q6016RH3	S	TO-220 (N.ISOL)
SM16JZ41	Q6025P5	S	FASTPAK (ISOL)
SM16JZ47	Q6016LH4	S	TO-220 (ISOL)
SM16JZ47A	Q6016LH3	S	TO-220 (ISOL)
SM1D43	L201E6	S	TO-92 (ISOL)
SM1G43	L401E6	S	TO-92 (ISOL)
SM25DZ41	Q2025P5	S	FASTPAK (ISOL)
SM25GZ41	Q4025P5	S	FASTPAK (ISOL)
SM25JZ41	Q6025P5	S	FASTPAK (ISOL)
SM2B41	Q2004F31	S	TO-202 (N.ISOL)
SM2D41	Q2004F31	S	TO-202 (N.ISOL)
SM2G41	Q4004F31	S	TO-202 (N.ISOL)
SM3B41	Q2004F41	S	TO-202 (N.ISOL)
SM3D41	Q2004F41	S	TO-202 (N.ISOL)
SM3G41	Q4004F41	S	TO-202 (N.ISOL)
SM3G45	Q4004L3	D	TO-220 (ISOL)
SM3GZ46	Q4004L3	S	TO-220 (ISOL)
SM3J41	Q6004F41	S	TO-202 (N.ISOL)
SM3J45	Q6004L3	D	TO-220 (ISOL)
SM3JZ46	Q6004L3	S	TO-220 (ISOL)

Part Number	Teccor Device	Direct or Suggested Replacement	Teccor Package
SM6D45	Q2006R4	S	TO-220 (N.ISOL)
SM6D45A	Q2006R4	S	TO-220 (N.ISOL)
SM6DZ46	Q2006L4	S	TO-220 (ISOL)
SM6DZ46A	Q2006L4	S	TO-220 (ISOL)
SM6G45	Q4006R4	S	TO-220 (N.ISOL)
SM6G45A	Q4006R4	S	TO-220 (N.ISOL)
SM6GZ46	Q4006L4	S	TO-220 (ISOL)
SM6GZ46A	Q4006L4	S	TO-220 (ISOL)
SM6GZ47	Q4006L4	S	TO-220 (ISOL)
SM6GZ47A	Q4006L4	S	TO-220 (ISOL)
SM6J45	Q6006R4	S	TO-220 (N.ISOL)
SM6J45A	Q6006R4	S	TO-220 (N.ISOL)
SM6JZ46	Q6006L4	S	TO-220 (ISOL)
SM6JZ46A	Q6006L4	S	TO-220 (ISOL)
SM6JZ47	Q6006L4	S	TO-220 (ISOL)
SM6JZ47A	Q6006L4	S	TO-220 (ISOL)
SM8D41	Q2008R4	D	TO-220 (N.ISOL)
SM8D45	Q2010R4	S	TO-220 (N.ISOL)
SM8D45A	L2008L8	S	TO-220 (N.ISOL)
SM8DZ46	Q2010L4	S	TO-220 (ISOL)
SM8DZ46A	L2008L8	S	TO-220 (ISOL)
SM8G41	Q4008R4	D	TO-220 (N.ISOL)
SM8G45	Q4010R4	S	TO-220 (N.ISOL)
SM8G45A	L4008L8	S	TO-220 (N.ISOL)
SM8GZ46	Q4010L4	S	TO-220 (ISOL)
SM8GZ46A	L4008L8	S	TO-220 (ISOL)
SM8GZ47	Q4008LH4	S	TO-220 (ISOL)
SM8GZ47A	Q4008LH4	S	TO-220 (ISOL)
SM8J41	Q6008R5	D	TO-220 (N.ISOL)
SM8J45	Q6010R4	S	TO-220 (N.ISOL)
SM8J45A	L6008L8	S	TO-220 (N.ISOL)
SM8JZ46	Q6010L4	S	TO-220 (ISOL)
SM8JZ46A	L6008L8	S	TO-220 (ISOL)
SM8JZ47	Q6008LH4	S	TO-220 (ISOL)
SM8JZ47A	Q6008LH4	S	TO-220 (ISOL)
ST2	HT32	D	DO-35 (ISOL)
T0505MH	L6006L5	S	TO-220 (ISOL)
T0509MH	L6006L6	S	TO-220 (ISOL)
T0510DH	L4006L8	S	TO-220 (ISOL)
T0510MH	L6006L8	S	TO-220 (ISOL)
T0605DH	L4006L5	S	TO-220 (ISOL)
T0605MH	L6006L5	S	TO-220 (ISOL)
T0609DH	L4006L6	S	TO-220 (ISOL)
T0609MH	L6006L6	S	TO-220 (ISOL)
T0612BH	Q2004R4	D	TO-220 (N.ISOL)
T0612DH	Q4006R4	D	TO-220 (N.ISOL)
T0612MH	Q6006R5	D	TO-220 (N.ISOL)
T0805DH	L4008L6	S	TO-220 (ISOL)
T0805MH	L6008L6	S	TO-220 (ISOL)
T0809DH	L4008L8	S	TO-220 (ISOL)
T0809MH	L6008L8	S	TO-220 (ISOL)
T0810DH	Q4008R4	S	TO-220 (N.ISOL)
T0810MH	Q6008R5	S	TO-220 (N.ISOL)
T0810NH	Q8008R5	S	TO-220 (N.ISOL)
T0810SH	Q8008R5	S	TO-220 (N.ISOL)
T0812DH	Q4008R4	S	TO-220 (N.ISOL)
T0812MH	Q6008R5	S	TO-220 (N.ISOL)
T0812NH	Q8008R5	S	TO-220 (N.ISOL)
T0812SH	Q8008R5	S	TO-220 (N.ISOL)
T1010BH	Q2010R5	S	TO-220 (N.ISOL)
T1010BJ	Q2010L5	D	TO-220 (ISOL)
T1010DH	Q4010R5	S	TO-220 (N.ISOL)
T1010DJ	Q4010L5	D	TO-220 (ISOL)
T1010MH	Q6010R5	S	TO-220 (N.ISOL)
T1010MJ	Q6010L5	D	TO-220 (ISOL)
T1010NH	Q8010R5	S	TO-220 (N.ISOL)
T1010NJ	Q8010L5	D	TO-220 (ISOL)
T1012BH	Q2010R5	D	TO-220 (N.ISOL)
T1012BJ	Q2010L5	D	TO-220 (ISOL)
T1012DH	Q4010R5	D	TO-220 (N.ISOL)

Part Number	Teccor Device	Direct or Suggested Replacement	Teccor Package
T1012DJ	Q4010L5	D	TO-220 (ISOL)
T1012MH	Q6010R5	D	TO-220 (N.ISOL)
T1012MJ	Q6010L5	D	TO-220 (ISOL)
T1012NH	Q8010R5	S	TO-220 (N.ISOL)
T1012NJ	Q8010L5	S	TO-220 (ISOL)
T1013BH	Q2010R5	D	TO-220 (N.ISOL)
T1013BJ	Q2010L5	D	TO-220 (ISOL)
T1013DH	Q4010R5	D	TO-220 (N.ISOL)
T1013DJ	Q4010L5	D	TO-220 (ISOL)
T1013MH	Q6010R5	D	TO-220 (N.ISOL)
T1013MJ	Q6010L5	D	TO-220 (ISOL)
T1013NH	Q8010R5	D	TO-220 (N.ISOL)
T1013NJ	Q8010L5	D	TO-220 (ISOL)
T106A1SC	L2004F31	D	TO-202 (N.ISOL)
T106A1SD	L2004F51	D	TO-202 (N.ISOL)
T106A1SG	L2004F61	D	TO-202 (N.ISOL)
T106A1SH	L2004F81	D	TO-202 (N.ISOL)
T106A1SHA	Q2004F41	D	TO-202 (N.ISOL)
T106A1SS	L2004F31	D	TO-202 (N.ISOL)
T106A2SS	L2004F32	D	TO-202 (N.ISOL)
T106B1SC	L2004F31	D	TO-202 (N.ISOL)
T106B1SD	L2004F51	D	TO-202 (N.ISOL)
T106B1SG	L2004F61	D	TO-202 (N.ISOL)
T106B1SGA	Q2004F31	D	TO-202 (N.ISOL)
T106B1SH	L2004F81	D	TO-202 (N.ISOL)
T106B1SHA	Q2004F41	D	TO-202 (N.ISOL)
T106B1SS	L2004F31	D	TO-202 (N.ISOL)
T106B2SD	L2004F52	D	TO-202 (N.ISOL)
T106B2SG	L2004F62	D	TO-202 (N.ISOL)
T106B2SGA	Q2004F32	D	TO-202 (N.ISOL)
T106B2SH	L2004F82	D	TO-202 (N.ISOL)
T106B2SHA	Q2004F42	D	TO-202 (N.ISOL)
T106B2SS	L2004F32	D	TO-202 (N.ISOL)
T106C1SC	L4004F31	D	TO-202 (N.ISOL)
T106C1SD	L4004F51	D	TO-202 (N.ISOL)
T106C1SG	L4004F61	D	TO-202 (N.ISOL)
T106C1SGA	Q4004F31	D	TO-202 (N.ISOL)
T106C1SH	L4004F81	D	TO-202 (N.ISOL)
T106C1SHA	Q4004F41	D	TO-202 (N.ISOL)
T106C1SS	L4004F31	D	TO-202 (N.ISOL)
T106C2SD	L4004F52	D	TO-202 (N.ISOL)
T106C2SG	L4004F62	D	TO-202 (N.ISOL)
T106C2SGA	Q4004F32	D	TO-202 (N.ISOL)
T106C2SH	L4004F82	D	TO-202 (N.ISOL)
T106C2SHA	Q4004F42	D	TO-202 (N.ISOL)
T106C2SS	L4004F32	D	TO-202 (N.ISOL)
T106D1SC	L4004F31	D	TO-202 (N.ISOL)
T106D1SD	L4004F51	D	TO-202 (N.ISOL)
T106D1SG	L4004F61	D	TO-202 (N.ISOL)
T106D1SGA	Q4004F31	D	TO-202 (N.ISOL)
T106D1SH	L4004F81	D	TO-202 (N.ISOL)
T106D1SHA	Q4004F41	D	TO-202 (N.ISOL)
T106D1SS	L4004F31	D	TO-202 (N.ISOL)
T106D2SD	L4004F52	D	TO-202 (N.ISOL)
T106D2SG	L4004F62	D	TO-202 (N.ISOL)
T106D2SGA	Q4004F32	D	TO-202 (N.ISOL)
T106D2SH	L4004F82	D	TO-202 (N.ISOL)
T106D2SHA	Q4004F42	D	TO-202 (N.ISOL)
T106D2SS	L4004F32	D	TO-202 (N.ISOL)
T106E1SC	L6004F31	D	TO-202 (N.ISOL)
T106E1SD	L6004F51	D	TO-202 (N.ISOL)
T106E1SG	L6004F61	D	TO-202 (N.ISOL)
T106E1SGA	Q6004F31	D	TO-202 (N.ISOL)
T106E1SH	L6004F81	D	TO-202 (N.ISOL)
T106E1SHA	Q6004F41	D	TO-202 (N.ISOL)
T106E1SS	L6004F31	D	TO-202 (N.ISOL)
T106E2SD	L6004F52	D	TO-202 (N.ISOL)
T106E2SG	L6004F62	D	TO-202 (N.ISOL)
T106E2SGA	Q6004F32	D	TO-202 (N.ISOL)
T106E2SH	L6004F82	D	TO-202 (N.ISOL)

Part Number	Teccor Device	Direct or Suggested Replacement	Teccor Package
T106E2SHA	Q6004F42	D	TO-202 (N.ISOL)
T106E2SS	L4004F32	D	TO-202 (N.ISOL)
T106F1SC	L2004F31	D	TO-202 (N.ISOL)
T106F1SD	L2004F51	D	TO-202 (N.ISOL)
T106F1SG	L2004F61	D	TO-202 (N.ISOL)
T106F1SGA	Q2004F31	D	TO-202 (N.ISOL)
T106F1SH	L2004F81	D	TO-202 (N.ISOL)
T106F1SHA	Q2004F41	D	TO-202 (N.ISOL)
T106F1SS	L2004F31	D	TO-202 (N.ISOL)
T106F2SC	L2004F32	D	TO-202 (N.ISOL)
T106F2SD	L2004F52	D	TO-202 (N.ISOL)
T106F2SG	L2004F62	D	TO-202 (N.ISOL)
T106F2SGA	Q2004F32	D	TO-202 (N.ISOL)
T106F2SH	L2004F82	D	TO-202 (N.ISOL)
T106F2SHA	Q2004F42	D	TO-202 (N.ISOL)
T106F2SS	L2004F32	D	TO-202 (N.ISOL)
T106M1SD	L6004F51	D	TO-202 (N.ISOL)
T106M1SG	L6004F61	D	TO-202 (N.ISOL)
T106M1SGA	Q6004F31	D	TO-202 (N.ISOL)
T106M1SH	L6004F81	D	TO-202 (N.ISOL)
T106M1SHA	Q6004F41	D	TO-202 (N.ISOL)
T106M1SS	L6004F31	D	TO-202 (N.ISOL)
T106M2SD	L6004F52	D	TO-202 (N.ISOL)
T106M2SG	L6004F62	D	TO-202 (N.ISOL)
T106M2SGA	Q6004F32	D	TO-202 (N.ISOL)
T106M2SH	L6004F82	D	TO-202 (N.ISOL)
T106M2SHA	Q6004F42	D	TO-202 (N.ISOL)
T106M2SS	L6004F32	D	TO-202 (N.ISOL)
T1210BH	Q2015R5	S	TO-220 (N.ISOL)
T1210DH	Q4015R5	S	TO-220 (N.ISOL)
T1210MH	Q6015R5	S	TO-220 (N.ISOL)
T1210NH	Q8015R5	S	TO-220 (N.ISOL)
T1212BH	Q2015R5	D	TO-220 (N.ISOL)
T1212BJ	Q4015L5	D	TO-220 (ISOL)
T1212DH	Q4015R5	D	TO-220 (N.ISOL)
T1212DJ	Q4015L5	D	TO-220 (ISOL)
T1212MH	Q6015R5	D	TO-220 (N.ISOL)
T1212MJ	Q6015L5	D	TO-220 (ISOL)
T1212NH	Q8015R5	D	TO-220 (N.ISOL)
T1212NJ	Q8015L5	D	TO-220 (ISOL)
T1213BH	Q2015R5	D	TO-220 (N.ISOL)
T1213BJ	Q4015L5	D	TO-220 (ISOL)
T1213DH	Q4015R5	D	TO-220 (N.ISOL)
T1213DJ	Q4015L5	D	TO-220 (ISOL)
T1213MH	Q6015R5	D	TO-220 (N.ISOL)
T1213MJ	Q6015L5	D	TO-220 (ISOL)
T1213NH	Q8015R5	D	TO-220 (N.ISOL)
T1213NJ	Q8015L5	D	TO-220 (ISOL)
T1235-600G	Q6012NH5	S	TO-263 (SMT)
T1235-800G	Q8012NH5	S	TO-263 (SMT)
T1512BJ	Q2015L5	D	TO-220 (ISOL)
T1512DJ	Q4015L5	D	TO-220 (ISOL)
T1512MJ	Q6015L5	D	TO-220 (ISOL)
T1512NJ	Q8015L5	D	TO-220 (ISOL)
T1513BJ	Q2015L5	D	TO-220 (ISOL)
T1513DJ	Q4015L5	D	TO-220 (ISOL)
T1513MJ	Q6015L5	D	TO-220 (ISOL)
T1513NJ	Q8015L5	D	TO-220 (ISOL)
T1612BH	Q2015R5	D	TO-220 (N.ISOL)
T1612DH	Q4015R5	D	TO-220 (N.ISOL)
T1612MH	Q6015R5	D	TO-220 (N.ISOL)
T1612NH	Q8015R5	D	TO-220 (N.ISOL)
T1612NJ	Q8015L5	D	TO-220 (ISOL)
T1613BH	Q2015R5	D	TO-220 (N.ISOL)
T1613DH	Q4015R5	D	TO-220 (N.ISOL)
T1613MH	Q6015R5	D	TO-220 (N.ISOL)
T1613NH	Q8015R	S	TO-220 (N.ISOL)
T1635-600G	Q6016NH4	D	TO-263 (SMT)
T1635-800G	Q8016NH4	D	TO-263 (SMT)
T2300A	L2004F321	S	TO-202 (N.ISOL)

Part Number	Teccor Device	Direct or Suggested Replacement	Teccor Package
T2300B	L2004F321	S	TO-202 (N.ISOL)
T2300D	L4004F321	S	TO-202 (N.ISOL)
T2300F	L2004F321	S	TO-202 (N.ISOL)
T2300PA	L2004F31	S	TO-202 (N.ISOL)
T2300PB	L2004F31	S	TO-202 (N.ISOL)
T2300PC	L4004F31	S	TO-202 (N.ISOL)
T2300PD	L4004F31	S	TO-202 (N.ISOL)
T2300PE	L6004F31	S	TO-202 (N.ISOL)
T2300PF	L2004F31	S	TO-202 (N.ISOL)
T2300PM	L6004F31	S	TO-202 (N.ISOL)
T2301A	L2004F321	S	TO-202 (N.ISOL)
T2301B	L2004F321	S	TO-202 (N.ISOL)
T2301D	L4004F321	S	TO-202 (N.ISOL)
T2301F	L2004F321	S	TO-202 (N.ISOL)
T2301PA	L2004F31	S	TO-202 (N.ISOL)
T2301PB	L2004F31	S	TO-202 (N.ISOL)
T2301PC	L4004F31	S	TO-202 (N.ISOL)
T2301PD	L4004F31	S	TO-202 (N.ISOL)
T2301PE	L6004F31	S	TO-202 (N.ISOL)
T2301PF	L2004F31	S	TO-202 (N.ISOL)
T2301PM	L6004F31	S	TO-202 (N.ISOL)
T2302A	L2004F621	S	TO-202 (N.ISOL)
T2302B	L2004F621	S	TO-202 (N.ISOL)
T2302D	L4004F621	S	TO-202 (N.ISOL)
T2302F	L2004F621	S	TO-202 (N.ISOL)
T2302PA	L2004F61	S	TO-202 (N.ISOL)
T2302PB	L2004F61	S	TO-202 (N.ISOL)
T2302PC	L4004F61	S	TO-202 (N.ISOL)
T2302PD	L4004F61	S	TO-202 (N.ISOL)
T2302PE	L6004F61	S	TO-202 (N.ISOL)
T2302PF	L2004F61	S	TO-202 (N.ISOL)
T2302PM	L6004F61	S	TO-202 (N.ISOL)
T2303F	Q2004F421	S	TO-202 (N.ISOL)
T2306A	Q2004F421	S	TO-202 (N.ISOL)
T2306B	Q2004F421	S	TO-202 (N.ISOL)
T2306D	Q4004F421	S	TO-202 (N.ISOL)
T2310A	L2004F321	S	TO-202 (N.ISOL)
T2310B	L2004F321	S	TO-202 (N.ISOL)
T2310D	L4004F321	S	TO-202 (N.ISOL)
T2310F	L2004F321	S	TO-202 (N.ISOL)
T2311A	L2004F321	S	TO-202 (N.ISOL)
T2311B	L2004F321	S	TO-202 (N.ISOL)
T2311D	L4004F321	S	TO-202 (N.ISOL)
T2311F	L2004F321	S	TO-202 (N.ISOL)
T2312A	L2004F621	S	TO-202 (N.ISOL)
T2312B	L2004F621	S	TO-202 (N.ISOL)
T2312D	L4004F621	S	TO-202 (N.ISOL)
T2312F	L2004F621	S	TO-202 (N.ISOL)
T2313A	Q2004F421	S	TO-202 (N.ISOL)
T2313B	Q2004F421	S	TO-202 (N.ISOL)
T2313D	Q4004F421	S	TO-202 (N.ISOL)
T2313F	Q2004F421	S	TO-202 (N.ISOL)
T2316A	Q2004F421	S	TO-202 (N.ISOL)
T2316B	Q2004F421	S	TO-202 (N.ISOL)
T2316D	Q4004F421	S	TO-202 (N.ISOL)
T2320A	L2004F31	D	TO-202 (N.ISOL)
T2320B	L2004F31	D	TO-202 (N.ISOL)
T2320C	L4004F31	D	TO-202 (N.ISOL)
T2320D	L4004F31	D	TO-202 (N.ISOL)
T2320E	L6004F31	D	TO-202 (N.ISOL)
T2320F	L2004F31	D	TO-202 (N.ISOL)
T2320M	L6004F31	D	TO-202 (N.ISOL)
T2322A	L2004F61	D	TO-202 (N.ISOL)
T2322B	L2004F61	D	TO-202 (N.ISOL)
T2322C	L4004F61	D	TO-202 (N.ISOL)
T2322D	L4004F61	D	TO-202 (N.ISOL)
T2322E	L6004F61	D	TO-202 (N.ISOL)
T2322F	L2004F61	D	TO-202 (N.ISOL)
T2322M	L6004F61	D	TO-202 (N.ISOL)
T2323A	L2004F81	D	TO-202 (N.ISOL)

Part Number	Teccor Device	Direct or Suggested Replacement	Teccor Package
T2323B	L2004F81	D	TO-202 (N.ISOL)
T2323C	L4004F81	D	TO-202 (N.ISOL)
T2323D	L4004F81	D	TO-202 (N.ISOL)
T2323E	L6004F81	D	TO-202 (N.ISOL)
T2323F	L2004F81	D	TO-202 (N.ISOL)
T2323M	L6004F81	D	TO-202 (N.ISOL)
T2327A	L2004F51	D	TO-202 (N.ISOL)
T2327B	L2004F51	D	TO-202 (N.ISOL)
T2327C	L4004F51	D	TO-202 (N.ISOL)
T2327D	L4004F51	D	TO-202 (N.ISOL)
T2327E	L6004F51	D	TO-202 (N.ISOL)
T2327F	L2004F51	D	TO-202 (N.ISOL)
T2327M	L6004F51	D	TO-202 (N.ISOL)
T2500A	Q2006R4	D	TO-220 (N.ISOL)
T2500AFP	Q2006L4	D	TO-220 (ISOL)
T2500B	Q2006R4	D	TO-220 (N.ISOL)
T2500BFP	Q2006L4	D	TO-220 (ISOL)
T2500C	Q4006R4	D	TO-220 (N.ISOL)
T2500CFP	Q4006L4	D	TO-220 (ISOL)
T2500D	Q4006R4	D	TO-220 (N.ISOL)
T2500DFP	Q4006L4	D	TO-220 (ISOL)
T2500E	Q6006R4	D	TO-220 (N.ISOL)
T2500EFP	Q6006L4	D	TO-220 (ISOL)
T2500M	Q6006R5	D	TO-220 (N.ISOL)
T2500MFP	Q6006L5	D	TO-220 (ISOL)
T2500N	Q8006R5	D	TO-220 (N.ISOL)
T2500NFP	Q8006L5	D	TO-220 (ISOL)
T2500S	Q8006R5	D	TO-220 (N.ISOL)
T2500SFP	Q8006L5	D	TO-220 (ISOL)
T2506B	Q2006R4	D	TO-220 (N.ISOL)
T2506D	Q4006R4	D	TO-220 (N.ISOL)
T2512BH	Q2025R5	S	TO-220 (N.ISOL)
T2512BK	Q6025P5	S	FASTPAK (ISOL)
T2512DH	Q4025R5	S	TO-220 (N.ISOL)
T2512DK	Q6025P5	S	FASTPAK (ISOL)
T2512MH	Q6025R5	S	TO-220 (N.ISOL)
T2512MK	Q6025P5	S	FASTPAK (ISOL)
T2512NH	Q8025R5	S	TO-220 (N.ISOL)
T2512NK	Q8025P5	S	FASTPAK (ISOL)
T2513BH	Q2025R5	S	TO-220 (N.ISOL)
T2513BK	Q6025P5	S	FASTPAK (ISOL)
T2513DH	Q4025R5	S	TO-220 (N.ISOL)
T2513DK	Q6025P5	S	FASTPAK (ISOL)
T2513MH	Q6025R5	S	TO-220 (N.ISOL)
T2513MK	Q6025P5	S	FASTPAK (ISOL)
T2513NH	Q8025R5	S	TO-220 (N.ISOL)
T2513NK	Q8025P5	S	FASTPAK (ISOL)
T2535-600G	Q6025NH6	S	TO-263 (SMT)
T2535-800G	Q8025NH6	S	TO-263 (SMT)
T2700B	Q2006R4	S	TO-220 (N.ISOL)
T2700D	Q4006R4	S	TO-220 (N.ISOL)
T2800A	Q2008R4	S	TO-220 (N.ISOL)
T2800B	Q2008R4	S	TO-220 (N.ISOL)
T2800C	Q4008R4	S	TO-220 (N.ISOL)
T2800D	Q4008R4	S	TO-220 (N.ISOL)
T2800E	Q6008R4	S	TO-220 (N.ISOL)
T2800M	Q6008R5	S	TO-220 (N.ISOL)
T2801A	Q2006R4	D	TO-220 (N.ISOL)
T2801B	Q2006R4	D	TO-220 (N.ISOL)
T2801C	Q4006R4	D	TO-220 (N.ISOL)
T2801D	Q4006R4	D	TO-220 (N.ISOL)
T2801E	Q6006R4	D	TO-220 (N.ISOL)
T2801M	Q6006R5	D	TO-220 (N.ISOL)
T2801N	Q8006R5	D	TO-220 (N.ISOL)
T2801S	Q8006R5	D	TO-220 (N.ISOL)
T2802A	Q2008R4	S	TO-220 (N.ISOL)
T2802B	Q2008R4	S	TO-220 (N.ISOL)
T2802C	Q4008R4	S	TO-220 (N.ISOL)
T2802D	Q4008R4	S	TO-220 (N.ISOL)
T2802E	Q6008R4	S	TO-220 (N.ISOL)

Part Number	Teccor Device	Direct or Suggested Replacement	Teccor Package
T2802M	Q6008R5	S	TO-220 (N.ISOL)
T2806B	Q2008R4	D	TO-220 (N.ISOL)
T2806D	Q4008R4	D	TO-220 (N.ISOL)
T2806M	Q6008R5	S	TO-220 (N.ISOL)
T2850A	Q2008L4	D	TO-220 (ISOL)
T2850B	Q2008L4	D	TO-220 (ISOL)
T2850D	Q4008L4	D	TO-220 (ISOL)
T2850E	Q6008L4	D	TO-220 (ISOL)
T2850F	Q2008L4	D	TO-220 (ISOL)
T2856B	Q2008L4	D	TO-220 (ISOL)
T2856D	Q4008L4	D	TO-220 (ISOL)
T4012DKS	Q6035P5	S	FASTPAK (ISOL)
T4012MKS	Q6035P5	S	FASTPAK (ISOL)
T4012NKS	Q8035P5	S	FASTPAK (ISOL)
T4012SKS	Q8035P5	S	FASTPAK (ISOL)
T4013DKS	Q6035P5	S	FASTPAK (ISOL)
T4013MKS	Q6035P5	S	FASTPAK (ISOL)
T4013NKS	Q8035P5	S	FASTPAK (ISOL)
T4013SKS	Q8035P5	S	FASTPAK (ISOL)
T405-400T	L4004L6	S	TO-220 (ISOL)
T405-400W	L4004L6	D	TO-220 (ISOL)
T405-600B	L6004D6	S	TO-252 (SMT)
T405-600H	L6004V6	S	TO-251 (N.ISOL)
T405-600T	L6004L6	S	TO-220 (ISOL)
T405-600W	L6004L6	D	TO-220 (ISOL)
T410-400T	L4004L8	S	TO-220 (ISOL)
T410-400W	L4004L8	D	TO-220 (ISOL)
T410-600B	L6006DH3	S	TO-252 (SMT)
T410-600H	L6006VH3	S	TO-251 (N.ISOL)
T410-600T	L6004L8	S	TO-220 (ISOL)
T410-600W	L6004L8	D	TO-220 (ISOL)
T435-400T	Q4006RH4	D	TO-220 (N.ISOL)
T435-400W	Q4006LH4	D	TO-220 (ISOL)
T435-600B	Q6006DH4	S	TO-252 (SMT)
T435-600H	Q6006VH4	S	TO-251 (N.ISOL)
T435-600T	Q6006RH4	D	TO-220 (N.ISOL)
T435-600W	Q6006LH4	D	TO-220 (ISOL)
T435-700T	Q8006RH4	D	TO-220 (N.ISOL)
T435-700W	Q8006LH4	D	TO-220 (ISOL)
T435-800T	Q8006RH4	D	TO-220 (N.ISOL)
T435-800W	Q8006LH4	D	TO-220 (ISOL)
T6000B	Q2015R5	D	TO-220 (N.ISOL)
T6000D	Q4015R5	D	TO-220 (N.ISOL)
T6000M	Q6015R5	D	TO-220 (N.ISOL)
T6001B	Q2015R5	D	TO-220 (N.ISOL)
T6001D	Q4015R5	D	TO-220 (N.ISOL)
T6001M	Q6015R5	D	TO-220 (N.ISOL)
T6006B	Q2015R5	S	TO-220 (N.ISOL)
T6006D	Q4015R5	S	TO-220 (N.ISOL)
T6006M	Q6015R5	S	TO-220 (N.ISOL)
T620-400W	Q4006LH4	S	TO-220 (ISOL)
T620-600W	Q6006LH4	S	TO-220 (ISOL)
T620-700W	Q8006LH4	S	TO-220 (ISOL)
T630-400W	Q4006LH4	S	TO-220 (ISOL)
T630-600W	Q6006LH4	S	TO-220 (ISOL)
T630-700W	Q8006LH4	S	TO-220 (ISOL)
T810-400B	Q4008DH3	D	TO-252 (SMT)
T810-600B	Q6008DH3	D	TO-252 (SMT)
T820-400W	Q4008LH4	S	TO-220 (ISOL)
T820-600W	Q6008LH4	S	TO-220 (ISOL)
T820-700W	Q8008LH4	S	TO-220 (ISOL)
T830-400W	Q4008LH4	S	TO-220 (ISOL)
T830-600W	Q6008LH4	S	TO-220 (ISOL)
T830-700W	Q8008LH4	S	TO-220 (ISOL)
T835-600B	Q6008DH4	D	TO-252 (SMT)
T835-600G	Q6008NH4	D	TO-263 (SMT)
T850-600G	Q6010NH5	D	TO-263 (SMT)
TIC106D	T106D1	S	TO-220 (N.ISOL)
TIC106M	T106M1	S	TO-220 (N.ISOL)
TIC108D	T107D1	S	TO-220 (N.ISOL)

Part Number	Teccor Device	Direct or Suggested Replacement	Teccor Package
TIC108M	T107M1	S	TO-220 (N.ISOL)
TIC116D	S4008R	D	TO-220 (N.ISOL)
TIC116M	S6008R	D	TO-220 (N.ISOL)
TIC116N	S8008R	D	TO-220 (N.ISOL)
TIC116S	S8008R	D	TO-220 (N.ISOL)
TIC126D	S4012R	D	TO-220 (N.ISOL)
TIC126M	S6012R	D	TO-220 (N.ISOL)
TIC126N	S8012R	D	TO-220 (N.ISOL)
TIC126S	S8012R	D	TO-220 (N.ISOL)
TIC201D	L4004F61	S	TO-220 (N.ISOL)
TIC201M	L6004F61	S	TO-220 (N.ISOL)
TIC206D	L4004F61	S	TO-220 (N.ISOL)
TIC206M	L6004F61	S	TO-220 (N.ISOL)
TIC216D	L4006F61	S	TO-220 (N.ISOL)
TIC216M	L6006F61	S	TO-220 (N.ISOL)
TIC225D	L4008F61	S	TO-220 (N.ISOL)
TIC225M	L6008F61	S	TO-220 (N.ISOL)
TIC226D	Q4008R4	D	TO-220 (N.ISOL)
TIC226M	Q6008R5	D	TO-220 (N.ISOL)
TIC226N	Q8008R5	D	TO-220 (N.ISOL)
TIC226S	Q8008R5	D	TO-220 (N.ISOL)
TIC236D	Q4015R5	D	TO-220 (N.ISOL)
TIC236M	Q6015R5	D	TO-220 (N.ISOL)
TIC236N	Q8015R5	D	TO-220 (N.ISOL)
TIC236S	Q8015R5	D	TO-220 (N.ISOL)
TIC246D	Q4015R5	S	TO-220 (N.ISOL)
TIC246M	Q6015R5	S	TO-220 (N.ISOL)
TIC246N	Q8015R5	S	TO-220 (N.ISOL)
TIC246S	Q8015R5	S	TO-220 (N.ISOL)
TIC256D	Q4025R5	S	TO-220 (N.ISOL)
TIC256D	Q4025R5	S	TO-220 (N.ISOL)
TIC256M	Q6025R5	S	TO-220 (N.ISOL)
TIC256N	Q8025R5	S	TO-220 (N.ISOL)
TIC256S	Q7025R5	S	TO-220 (N.ISOL)
TICP106D	TCR22-4	S	TO-92
TICP106M	TCR22-8	S	TO-92
TL1003	S2006F2	S	TO-202 (N.ISOL) ?
TL1006	S2006F2	S	TO-202 (N.ISOL)
TL106-05	T106B2	D	TO-202 (N.ISOL)
TL106-1	T106B2	D	TO-202 (N.ISOL)
TL106-2	T106B2	D	TO-202 (N.ISOL)
TL106-4	T106D2	D	TO-202 (N.ISOL)
TL106-6	T106M2	D	TO-202 (N.ISOL)
TL107-05	T107B2	D	TO-202 (N.ISOL)
TL107-1	T107B2	D	TO-202 (N.ISOL)
TL107-2	T107B2	D	TO-202 (N.ISOL)
TL107-4	T107D2	D	TO-202 (N.ISOL)
TL107-6	T107M2	D	TO-202 (N.ISOL)
TL2003	S2006F2	S	TO-202 (N.ISOL)
TL2006	S2006F2	S	TO-202 (N.ISOL)
TL4003	S4006F2	S	TO-202 (N.ISOL)
TL4006	S4006F2	S	TO-202 (N.ISOL)
TL6003	S6006F2	S	TO-202 (N.ISOL)
TL6006	S6006F2	S	TO-202 (N.ISOL)
TLC111A	L2004F62	D	TO-202 (N.ISOL)
TLC111B	Q2004F42	D	TO-202 (N.ISOL)
TLC111D	L2004F52	D	TO-202 (N.ISOL)
TLC111S	L2004F62	D	TO-202 (N.ISOL)
TLC111T	L2004F52	D	TO-202 (N.ISOL)
TLC113B	Q2004F42	D	TO-202 (N.ISOL)
TLC1165	L2004F62	D	TO-202 (N.ISOL)
TLC116A	L2004F62	D	TO-202 (N.ISOL)
TLC116B	Q2004F42	D	TO-202 (N.ISOL)
TLC116D	L2004F52	D	TO-202 (N.ISOL)
TLC116T	L2004F52	D	TO-202 (N.ISOL)
TLC221A	L4004F62	D	TO-202 (N.ISOL)
TLC221B	Q4004F42	D	TO-202 (N.ISOL)
TLC221D	L4004F52	D	TO-202 (N.ISOL)
TLC221S	L4004F62	D	TO-202 (N.ISOL)
TLC221T	L4004F52	D	TO-202 (N.ISOL)

Part Number	Teccor Device	Direct or Suggested Replacement	Teccor Package
TLC223A	L4004F62	D	TO-202 (N.ISOL)
TLC223B	Q4004F42	D	TO-202 (N.ISOL)
TLC223D	L4004F52	D	TO-202 (N.ISOL)
TLC226A	L4004F62	D	TO-202 (N.ISOL)
TLC226B	Q4004F42	D	TO-202 (N.ISOL)
TLC226D	L4004F52	D	TO-202 (N.ISOL)
TLC226S	L4004F62	D	TO-202 (N.ISOL)
TLC226T	L4004F52	D	TO-202 (N.ISOL)
TLC331A	L6004F62	D	TO-202 (N.ISOL)
TLC331B	Q6004F42	D	TO-202 (N.ISOL)
TLC331D	L6004F52	D	TO-202 (N.ISOL)
TLC331S	L6004F62	D	TO-202 (N.ISOL)
TLC331T	L6004F52	D	TO-202 (N.ISOL)
TLC333A	L6004F62	D	TO-202 (N.ISOL)
TLC333B	Q6004F42	D	TO-202 (N.ISOL)
TLC333D	L6004F52	D	TO-202 (N.ISOL)
TLC336A	L6004F62	D	TO-202 (N.ISOL)
TLC336B	Q6004F42	D	TO-202 (N.ISOL)
TLC336D	L6004F52	D	TO-202 (N.ISOL)
TLC336S	L6004F62	D	TO-202 (N.ISOL)
TLC336T	L6004F52	D	TO-202 (N.ISOL)
TLC386B	Q7004F42	D	TO-202 (N.ISOL)
TLS106-05	T106B2	D	TO-202 (N.ISOL)
TLS106-1	T106B2	D	TO-202 (N.ISOL)
TLS106-2	T106B2	D	TO-202 (N.ISOL)
TLS106-4	T106D2	D	TO-202 (N.ISOL)
TLS106-6	T106M2	D	TO-202 (N.ISOL)
TLS107-05	T107B2	D	TO-202 (N.ISOL)
TLS107-1	T107B2	D	TO-202 (N.ISOL)
TLS107-2	T107B2	D	TO-202 (N.ISOL)
TLS107-4	T107D2	D	TO-202 (N.ISOL)
TLS107-6	T107M2	D	TO-202 (N.ISOL)
TN1215-600B	S6012D	S	TO-252 (SMT)
TN1215-600H	S6012V	S	TO-251 (N.ISOL)
TN1215-800B	S8012D	S	TO-252 (SMT)
TN1215-800H	S8012V	S	TO-251 (N.ISOL)
TN1625-1000G	SK016N	S	TO-263 (SMT)
TN1625-600G	S6016N	S	TO-263 (SMT)
TN1625-800G	S8016N	S	TO-263 (SMT)
TN815-600B	S6008D	D	TO-252 (SMT)
TN815-600H	S6008V	D	TO-251 (N.ISOL)
TN815-800B	S8008D	D	TO-252 (SMT)
TN815-800H	S8008V	D	TO-251 (N.ISOL)
TO1013BJ	Q2010L5	D	TO-220 (ISOL)
TO1013DJ	Q4010L5	D	TO-220 (ISOL)
TO1013MJ	Q6010L5	D	TO-220 (ISOL)
TO1013NJ	Q8010L5	D	TO-220 (ISOL)
TO409BJ	L2004L6	D	TO-220 (ISOL)
TO409DJ	L4004L6	D	TO-220 (ISOL)
TO409MJ	L6004L6	D	TO-220 (ISOL)
TO410BJ	L2004L8	D	TO-220 (ISOL)
TO410DJ	L4004L8	D	TO-220 (ISOL)
TO410MJ	L6004L8	D	TO-220 (ISOL)
TO505BH	L2006L5	S	TO-220 (ISOL)
TO505DH	L4006L5	S	TO-220 (ISOL)
TO509BH	L2006L6	S	TO-220 (ISOL)
TO509DH	L2006L6	S	TO-220 (ISOL)
TO510BH	L2006L8	S	TO-220 (ISOL)
TO512BH	Q2006R4	D	TO-220 (N.ISOL)
TO512DH	Q4006R4	D	TO-220 (N.ISOL)
TO512MH	Q6006R5	S	TO-220 (N.ISOL)
TO605BH	L2006L5	S	TO-220 (ISOL)
TO605DH	L4006L5	S	TO-220 (ISOL)
TO605MH	L6006L5	S	TO-220 (ISOL)
TO609BH	L2006L6	S	TO-220 (ISOL)
TO609BJ	L2006L6	D	TO-220 (ISOL)
TO609DH	L4006L6	S	TO-220 (ISOL)
TO609DJ	L4006L6	D	TO-220 (ISOL)
TO609MH	L6006L6	S	TO-220 (ISOL)
TO609MJ	L6006L6	D	TO-220 (ISOL)

Part Number	Teccor Device	Direct or Suggested Replacement	Teccor Package
TO610BH	L2006L8	S	TO-220 (ISOL)
TO610BJ	L2006L8	D	TO-220 (ISOL)
TO610DH	L4006L8	S	TO-220 (ISOL)
TO610DJ	L4006L8	D	TO-220 (ISOL)
TO610MH	L6006L8	S	TO-220 (ISOL)
TO610MJ	L6006L8	D	TO-220 (ISOL)
TO612BJ	Q2006L4	S	TO-220 (ISOL)
TO612DJ	Q4006L4	S	TO-220 (ISOL)
TO612MJ	Q6006L5	S	TO-220 (ISOL)
TO805BH	L2008L6	S	TO-220 (ISOL)
TO805DH	L4008L6	S	TO-220 (ISOL)
TO805MH	L6008L6	S	TO-220 (ISOL)
TO809BH	L2008L6	S	TO-220 (ISOL)
TO809DH	L4008L6	S	TO-220 (ISOL)
TO809MH	L6008L6	S	TO-220 (ISOL)
TO810BH	L2008L8	S	TO-220 (ISOL)
TO810BJ	L2008L8	D	TO-220 (ISOL)
TO810DH	L4008L8	S	TO-220 (ISOL)
TO810DJ	L4008L8	D	TO-220 (ISOL)
TO810MH	L6008L8	S	TO-220 (ISOL)
TO810MJ	L6008L8	D	TO-220 (ISOL)
TO812BH	Q2008R4	S	TO-220 (N.ISOL)
TO812BJ	Q2008L4	S	TO-220 (ISOL)
TO812DH	Q4008R4	S	TO-220 (N.ISOL)
TO812DJ	Q4008L4	S	TO-220 (ISOL)
TO812MH	Q6008R5	S	TO-220 (N.ISOL)
TO812MJ	Q6008L5	S	TO-220 (ISOL)
TO812NH	Q8008L5	S	TO-220 (ISOL)
TO813BJ	Q2008L4	S	TO-220 (ISOL)
TO813DJ	Q4008L4	S	TO-220 (ISOL)
TO813MJ	Q6008L5	S	TO-220 (ISOL)
TO813NJ	Q8008L5	S	TO-220 (ISOL)
TPDV125	Q2025L6	S	TO-220 (ISOL)
TPDV140	Q2040K7	D	TO-218 (ISOL)
TPDV225	Q2025L6	S	TO-220 (ISOL)
TPDV240	Q2040K7	D	TO-218 (ISOL)
TPDV425	Q4025L6	S	TO-220 (ISOL)
TPDV440	Q4040J7	D	TO-218 (ISOL)
TPDV625	Q6025L6	S	TO-220 (ISOL)
TPDV640	Q6040K7	D	TO-218 (ISOL)
TPDV825	Q8025L6	S	TO-220 (ISOL)
TPDV840	Q8040K7	D	TO-218 (ISOL)
TS420-400T	T106D1	S	TO-202 (N.ISOL)
TS420-600B	S6004DS2	S	TO-252 (SMT)
TS420-600H	S6004VS2	S	TO-251 (N.ISOL)
TS420-600T	T106M1	S	TO-202 (N.ISOL)
TS820-400T	S4008FS21	S	TO-202 (N.ISOL)
TS820-600B	S6008DS2	S	TO-252 (SMT)
TS820-600H	S6008VS2	S	TO-251 (N.ISOL)
TS820-600T	S6008FS21	S	TO-202 (N.ISOL)
TXDV-212	Q2015L6	D	TO-220 (ISOL)
TXDV-412	Q4015L6	D	TO-220 (ISOL)
TXDV612	Q6015L6	D	TO-220 (ISOL)
TXDV812	Q8015L6	D	TO-220 (ISOL)
TXN0510	S2010L	D	TO-220 (ISOL)
TXN0512	S2015L	S	TO-220 (ISOL)
TXN056	S2006L	D	TO-220 (ISOL)
TXN058	S2008L	D	TO-220 (ISOL)
TXN058G	S2008L	D	TO-220 (ISOL)
TXN106	S2006L	D	TO-220 (ISOL)
TXN108	S2008L	S	TO-220 (ISOL)
TXN108G	S2008L	D	TO-220 (ISOL)
TXN110	S2010L	D	TO-220 (ISOL)
TXN112	S2015L	S	TO-220 (ISOL)
TXN204	S2006L	S	TO-220 (ISOL)
TXN206	S2006L	D	TO-220 (ISOL)
TXN208	S2008L	D	TO-220 (ISOL)
TXN208G	S2008L	D	TO-220 (ISOL)
TXN210	S2010L	D	TO-220 (ISOL)
TXN212	S2015L	S	TO-220 (ISOL)

Part Number	Teccor Device	Direct or Suggested Replacement	Teccor Package
TXN404	S4006L	S	TO-220 (ISOL)
TXN406	S4006L	D	TO-220 (ISOL)
TXN408	S4008L	D	TO-220 (ISOL)
TXN408G	S4008L	D	TO-220 (ISOL)
TXN410	S4010L	D	TO-220 (ISOL)
TXN412	S4015L	S	TO-220 (ISOL)
TXN604	S6006L	S	TO-220 (ISOL)
TXN606	S6006L	D	TO-220 (ISOL)
TXN608	S6008L	D	TO-220 (ISOL)
TXN608G	S6008L	D	TO-220 (ISOL)
TXN610	S6010L	D	TO-220 (ISOL)
TXN612	S6015L	S	TO-220 (ISOL)
TXN812	S8015L	S	TO-220 (ISOL)
TYN0510	S2010R	D	TO-220 (ISOL)
TYN0512	S2012R	D	TO-220 (ISOL)
TYN0516	S2016R	D	TO-220 (ISOL)
TYN054	S2006F1	S	TO-202 (N.ISOL)
TYN056	S2006F1	S	TO-202 (N.ISOL)
TYN058	S2008R	D	TO-220 (N.ISOL)
TYN058G	S2008R	S	TO-220 (N.ISOL)
TYN058K	S2008R	S	TO-220 (N.ISOL)
TYN104	S2006F1	S	TO-202 (N.ISOL)
TYN106	S2006F1	S	TO-202 (N.ISOL)
TYN108	S2008R	D	TO-220 (N.ISOL)
TYN108G	S2008R	S	TO-220 (N.ISOL)
TYN110	S2010R	D	TO-220 (N.ISOL)
TYN112	S2012R	D	TO-220 (N.ISOL)
TYN116	S2016R	D	TO-220 (N.ISOL)
TYN204	S2006F1	S	TO-202 (N.ISOL)
TYN206	S2006F1	S	TO-202 (N.ISOL)
TYN208	S2008R	D	TO-220 (N.ISOL)
TYN208G	S2008R	S	TO-220 (N.ISOL)
TYN208K	S2008R	S	TO-220 (N.ISOL)
TYN210	S2010R	D	TO-220 (N.ISOL)
TYN212	S2012R	D	TO-220 (N.ISOL)
TYN216	S2016R	D	TO-220 (N.ISOL)
TYN404	S4006F1	S	TO-202 (N.ISOL)
TYN406	S4006F1	S	TO-202 (N.ISOL)
TYN408	S4008R	D	TO-220 (N.ISOL)
TYN408G	S4008R	S	TO-220 (N.ISOL)
TYN408K	S4008R	S	TO-220 (N.ISOL)
TYN410	S4010R	D	TO-220 (N.ISOL)
TYN412	S4012R	S	TO-220 (N.ISOL)
TYN416	S4016R	D	TO-220 (N.ISOL)
TYN604	S6006F1	S	TO-202 (N.ISOL)
TYN606	S6006F1	S	TO-202 (N.ISOL)
TYN608	S6008R	D	TO-220 (N.ISOL)
TYN608G	S6008R	S	TO-220 (N.ISOL)
TYN608K	S6008R	S	TO-220 (N.ISOL)
TYN610	S6010R	D	TO-220 (N.ISOL)
TYN612	S6012R	D	TO-220 (N.ISOL)
TYN616	S6016R	D	TO-220 (N.ISOL)
TYN682	S2025R	D	TO-220 (N.ISOL)
TYN683	S2025R	D	TO-220 (N.ISOL)
TYN685	S2025R	D	TO-220 (N.ISOL)
TYN688	S4025R	D	TO-220 (N.ISOL)
TYN690	S6025R	D	TO-220 (N.ISOL)
TYN808	S8008R	D	TO-220 (N.ISOL)
TYN808G	S8008R	S	TO-220 (N.ISOL)
TYN808K	S8008R	S	TO-220 (N.ISOL)
TYN810	S8010R	S	TO-220 (N.ISOL)
TYN812	S8012R	D	TO-220 (N.ISOL)
TYN816	S8016R	D	TO-220 (N.ISOL)
TYS1006-05	S2010LS2	S	TO-220 (ISOL)
TYS1006-1	S2010LS2	S	TO-220 (ISOL)
TYS1006-2	S2010LS2	S	TO-220 (ISOL)
TYS1006-4	S4010LS2	S	TO-220 (ISOL)
TYS1007-05	S2010LS3	S	TO-220 (ISOL)
TYS1007-1	S2010LS2	S	TO-220 (ISOL)
TYS1007-2	S2010LS2	S	TO-220 (ISOL)

Part Number	Teccor Device	Direct or Suggested Replacement	Teccor Package
TYS1007-4	S4010LS2	S	TO-220 (ISOL)
TYS406-05	T106B1	S	TO-202 (N.ISOL)
TYS406-1	T106B1	S	TO-202 (N.ISOL)
TYS406-2	T106B1	S	TO-202 (N.ISOL)
TYS406-4	T106D1	S	TO-202 (N.ISOL)
TYS406-6	T106M1	S	TO-202 (N.ISOL)
TYS407-05	T107B1	S	TO-202 (N.ISOL)
TYS407-1	T107B1	S	TO-202 (N.ISOL)
TYS407-2	T107B1	S	TO-202 (N.ISOL)
TYS407-4	T107D1	S	TO-202 (N.ISOL)
TYS407-6	T107M1	S	TO-202 (N.ISOL)
TYS606-05	S2006LS2	D	TO-220 (ISOL)
TYS606-1	S2006LS2	D	TO-220 (ISOL)
TYS606-2	S2006LS2	D	TO-220 (ISOL)
TYS606-4	S4006LS2	D	TO-220 (ISOL)
TYS606-6	S6006LS2	S	TO-220 (ISOL)
TYS607-05	S2006LS3	D	TO-220 (ISOL)
TYS607-1	S2006LS3	D	TO-220 (ISOL)
TYS607-2	S2006LS3	D	TO-220 (ISOL)
TYS607-4	S4006LS3	D	TO-220 (ISOL)
TYS607-6	S6006LS3	S	TO-220 (ISOL)
TYS806-05	S2008LS2	D	TO-220 (ISOL)
TYS806-1	S2008LS2	D	TO-220 (ISOL)
TYS806-2	S2008LS2	D	TO-220 (ISOL)
TYS806-4	S4008LS2	D	TO-220 (ISOL)
TYS806-6	S6008LS2	S	TO-220 (ISOL)
TYS807-05	S2008LS3	D	TO-220 (ISOL)
TYS807-1	S2008LS3	D	TO-220 (ISOL)
TYS807-2	S2008LS3	D	TO-220 (ISOL)
TYS807-4	S4008LS3	D	TO-220 (ISOL)
TYS807-6	S6008LS3	S	TO-220 (ISOL)
X0101BA	EC103B1	S	TO-92 (ISOL)
X0101DA	EC103D1	S	TO-92 (ISOL)
X0101MA	EC103M1	S	TO-92 (ISOL)
X0102BA	EC103B	S	TO-92 (ISOL)
X0102DA	EC103D	S	TO-92 (ISOL)
X0102MA	EC103M	S	TO-92 (ISOL)
X0103BA	EC103B	S	TO-92 (ISOL)
X0103DA	EC103D	S	TO-92 (ISOL)
X0103MA	EC103M	S	TO-92 (ISOL)
X0104BA	EC103B2	D	TO-92 (ISOL)
X0104DA	EC103D2	D	TO-92 (ISOL)
X0104MA	EC103M2	D	TO-92 (ISOL)
X0105BA	EC103B2	S	TO-92 (ISOL)
X0105DA	EC103D2	S	TO-92 (ISOL)
X0105MA	EC103M2	S	TO-92 (ISOL)
X0106BA	EC103B	S	TO-92 (ISOL)
X0106DA	EC103D	S	TO-92 (ISOL)
X0106MA	EC103M	S	TO-92 (ISOL)
X0110BA	EC103B1	S	TO-92 (ISOL)
X0110DA	EC103D1	S	TO-92 (ISOL)
X0110MA	EC103M1	S	TO-92 (ISOL)
X0202BA	TCR22-4	D	TO-92 (ISOL)
X0202DA	TCR22-6	D	TO-92 (ISOL)
X0202MA	TCR22-8	D	TO-92 (ISOL)
X0203BA	TCR22-4	S	TO-92 (ISOL)
X0203DA	TCR22-6	S	TO-92 (ISOL)
X0203MA	TCR22-8	S	TO-92 (ISOL)
X0204BA	TCR22-4	S	TO-92 (ISOL)
X0204DA	TCR22-6	S	TO-92 (ISOL)
X0204MA	TCR22-8	S	TO-92 (ISOL)
X0205BA	EC103B2	S	TO-92 (ISOL)
X0205DA	EC103D2	S	TO-92 (ISOL)
X0205MA	EC103M2	S	TO-92 (ISOL)
X0206BA	TCR22-4	S	TO-92 (ISOL)
X0206DA	TCR22-6	S	TO-92 (ISOL)
X0402BE	T106B1	D	TO-202 (N.ISOL)
X0402BF	T106B2	D	TO-202 (N.ISOL)
X0402DE	T106D1	D	TO-202 (N.ISOL)
X0402DF	T106D2	D	TO-202 (N.ISOL)

Part Number	Teccor Device	Direct or Suggested Replacement	Teccor Package
X0402DG	T106D1	S	TO-202 (N.ISOL)
X0402ME	T106M1	D	TO-202 (N.ISOL)
X0402MF	T106M2	D	TO-202 (N.ISOL)
X0403BE	T106B1	S	TO-202 (N.ISOL)
X0403BF	T106B2	S	TO-202 (N.ISOL)
X0403DE	T106D1	S	TO-202 (N.ISOL)
X0403DF	T106D2	S	TO-202 (N.ISOL)
X0403ME	T106M1	S	TO-202 (N.ISOL)
X0403MF	T106M2	S	TO-202 (N.ISOL)
X0405BE	T106B1	S	TO-202 (N.ISOL)
X0405BF	T106B2	S	TO-202 (N.ISOL)
X0405DE	T106D1	S	TO-202 (N.ISOL)
X0405DF	T106D2	S	TO-202 (N.ISOL)
X0405ME	T106M1	S	TO-202 (N.ISOL)
X0405MF	T106M2	S	TO-202 (N.ISOL)
Z00607DA	L4X8E5	S	TO-92 (ISOL)
Z00607MA	L6X8E5	S	TO-92 (ISOL)
Z0102BA	L201E3	D	TO-92 (ISOL)
Z0102DA	L401E3	D	TO-92 (ISOL)
Z0102MA	L601E3	D	TO-92 (ISOL)
Z0103DN	L4N3	S	SOT223/COMPAK
Z0103MN	L6N3	S	SOT223/COMPAK
Z0105BA	L201E5	D	TO-92 (ISOL)
Z0105DA	L401E5	D	TO-92 (ISOL)
Z0105MA	L601E5	D	TO-92 (ISOL)
Z0107DN	L4N5	S	SOT223/COMPAK
Z0107MN	L6N5	S	SOT223/COMPAK
Z0109BA	L201E6	D	TO-92 (ISOL)
Z0109DA	L401E6	D	TO-92 (ISOL)
Z0109MA	L601E6	D	TO-92 (ISOL)
Z0110DA	L401E8	D	TO-92 (ISOL)
Z0110MA	L601E8	D	TO-92 (ISOL)
Z0302BG	L2004F321	S	TO-202 (N.ISOL)
Z0302DG	L4004F321	S	TO-202 (N.ISOL)
Z0302MG	L6004L3	S	TO-220 (ISOL)
Z0305BG	L2004F521	S	TO-202 (N.ISOL)
Z0305DG	L4004F521	S	TO-202 (N.ISOL)
Z0309BG	L2004F621	S	TO-202 (N.ISOL)
Z0309DG	L4004F621	S	TO-202 (N.ISOL)
Z0310BG	L2004F821	S	TO-202 (N.ISOL)
Z0310DG	L4004F821	S	TO-202 (N.ISOL)
Z0310MG	L6004L8	S	TO-220 (ISOL)
Z0405BE	L2004F51	D	TO-202 (N.ISOL)
Z0405BF	L2004F52	D	TO-202 (N.ISOL)
Z0405DE	L4004F51	D	TO-202 (N.ISOL)
Z0405DF	L4004F52	D	TO-202 (N.ISOL)
Z0405ME	L6004F51	D	TO-202 (N.ISOL)
Z0405MF	L6004F52	D	TO-202 (N.ISOL)
Z0409BE	L2004F61	D	TO-202 (N.ISOL)
Z0409BF	L2004F62	D	TO-202 (N.ISOL)
Z0409DE	L4004F61	D	TO-202 (N.ISOL)
Z0409DF	L4004F62	D	TO-202 (N.ISOL)
Z0409ME	L6004F61	D	TO-202 (N.ISOL)
Z0409MF	L6004F62	D	TO-202 (N.ISOL)
Z0410BE	L2004F81	D	TO-202 (N.ISOL)
Z0410BE	L2004F81	D	TO-202 (N.ISOL)
Z0410BF	L2004F82	D	TO-202 (N.ISOL)
Z0410BF	L2004F82	D	TO-202 (N.ISOL)
Z0410DE	L4004F81	D	TO-202 (N.ISOL)
Z0410DE	L4004F81	D	TO-202 (N.ISOL)
Z0410DF	L4004F82	D	TO-202 (N.ISOL)
Z0410ME	L6004F81	D	TO-202 (N.ISOL)
Z0410MF	L6004F82	D	TO-202 (N.ISOL)

Part Number Index

Part Number Index

TECCOR PART NO.	PAGE NO.	TECCOR PART NO.	PAGE NO.	TECCOR PART NO.	PAGE NO.	TECCOR PART NO.	PAGE NO.	TECCOR PART NO.	PAGE NO.
2N5064	E5-2	K1100E70	E9-2	L2004V6	E1-2	L4006D6	E1-4	L6006L6	E1-4
2N6565	E5-2	K1100G	E9-2	L2004V8	E1-2	L4006D8	E1-4	L6006L8	E1-4
D2015L	E7-2	K1100S	E9-2	L2006D5	E1-4	L4006L5	E1-4	L6006V5	E1-4
D2020L	E7-2	K1200E70	E9-2	L2006D6	E1-4	L4006L6	E1-4	L6006V6	E1-4
D2025L	E7-2	K1200G	E9-2	L2006D8	E1-4	L4006L8	E1-4	L6006V8	E1-4
D4015L	E7-2	K1200S	E9-2	L2006L5	E1-4	L4006V5	E1-4	L6008D6	E1-4
D4020L	E7-2	K1300E70	E9-2	L2006L6	E1-4	L4006V6	E1-4	L6008D8	E1-4
D4025L	E7-2	K1300G	E9-2	L2006L8	E1-4	L4006V8	E1-4	L6008L6	E1-4
D6015L	E7-2	K1300S	E9-2	L2006V5	E1-4	L4008D6	E1-4	L6008L8	E1-4
D6020L	E7-2	K1400E70	E9-2	L2006V6	E1-4	L4008D8	E1-4	L6008V6	E1-4
D6025L	E7-2	K1400G	E9-2	L2006V8	E1-4	L4008L6	E1-4	L6008V8	E1-4
D8015L	E7-2	K1400S	E9-2	L2008D6	E1-4	L4008L8	E1-4	L601E3	E1-2
D8020L	E7-2	K1500E70	E9-2	L2008D8	E1-4	L4008V6	E1-4	L601E5	E1-2
D8025L	E7-2	K1500G	E9-2	L2008L6	E1-4	L4008V8	E1-4	L601E6	E1-2
DK015L	E7-2	K1500S	E9-2	L2008L8	E1-4	L401E3	E1-2	L601E8	E1-2
DK020L	E7-2	K2000E70	E9-2	L2008V6	E1-4	L401E5	E1-2	L6N3	E1-2
DK025L	E7-2	K2000F1	E9-2	L2008V8	E1-4	L401E6	E1-2	L6N5	E1-2
EC103B	E5-2	K2000G	E9-2	L201E3	E1-2	L401E8	E1-2	L6X3	E1-2
EC103B1	E5-2	K2000S	E9-2	L201E5	E1-2	L4N3	E1-2	L6X5	E1-2
EC103B2	E5-2	K2200E70	E9-2	L201E6	E1-2	L4N5	E1-2	L6X8E3	E1-2
EC103B3	E5-2	K2200F1	E9-2	L201E8	E1-2	L4X3	E1-2	L6X8E5	E1-2
EC103D	E5-2	K2200G	E9-2	L2N3	E1-2	L4X5	E1-2	L6X8E6	E1-2
EC103D1	E5-2	K2200S	E9-2	L2N5	E1-2	L4X8E3	E1-2	L6X8E8	E1-2
EC103D2	E5-2	K2400E70	E9-2	L2X3	E1-2	L4X8E5	E1-2	Q2004D3	E2-2
EC103D3	E5-2	K2400F1	E9-2	L2X5	E1-2	L4X8E6	E1-2	Q2004D4	E2-2
EC103M	E5-2	K2400G	E9-2	L2X8E3	E1-2	L4X8E8	E1-2	Q2004F31	E2-2
EC103M1	E5-2	K2400S	E9-2	L2X8E5	E1-2	L6004D3	E1-2	Q2004F41	E2-2
EC103M2	E5-2	K2500E70	E9-2	L2X8E6	E1-2	L6004D5	E1-2	Q2004L3	E2-2
EC103M3	E5-2	K2500F1	E9-2	L2X8E8	E1-2	L6004D6	E1-2	Q2004L4	E2-2
HT-32	E8-2	K2500G	E9-2	L4004D3	E1-2	L6004D8	E1-2	Q2004LT	E3-2
HT-32A	E8-2	K2500S	E9-2	L4004D5	E1-2	L6004F31	E1-2	Q2004V3	E2-2
HT-32B	E8-2	K3000F1	E9-2	L4004D6	E1-2	L6004F51	E1-2	Q2004V4	E2-2
HT-34B	E8-2	L2004D3	E1-2	L4004D8	E1-2	L6004F61	E1-2	Q2006DH3	E4-2
HT-35	E8-2	L2004D5	E1-2	L4004F31	E1-2	L6004F81	E1-2	Q2006DH4	E4-2
HT-36A	E8-2	L2004D6	E1-2	L4004F51	E1-2	L6004L3	E1-2	Q2006F41	E2-2
HT-36B	E8-2	L2004D8	E1-2	L4004F61	E1-2	L6004L5	E1-2	Q2006L4	E2-2
HT-40	E8-2	L2004F31	E1-2	L4004F81	E1-2	L6004L6	E1-2	Q2006LH4	E4-2
HT-5761	E8-2	L2004F51	E1-2	L4004L3	E1-2	L6004L8	E1-2	Q2006LT	E3-2
HT-5761A	E8-2	L2004F61	E1-2	L4004L5	E1-2	L6004V3	E1-2	Q2006N4	E2-2
HT-5762	E8-2	L2004F81	E1-2	L4004L6	E1-2	L6004V5	E1-2	Q2006NH4	E4-2
K0900E70	E9-2	L2004L3	E1-2	L4004L8	E1-2	L6004V6	E1-2	Q2006R4	E2-2
K0900G	E9-2	L2004L5	E1-2	L4004V3	E1-2	L6004V8	E1-2	Q2006RH4	E4-2
K0900S	E9-2	L2004L6	E1-2	L4004V5	E1-2	L6006D5	E1-4	Q2006VH3	E4-2
K1050E70	E9-2	L2004L8	E1-2	L4004V6	E1-2	L6006D6	E1-4	Q2006VH4	E4-2
K1050G	E9-2	L2004V3	E1-2	L4004V8	E1-2	L6006D8	E1-4	Q2008DH3	E4-2
K1050S	E9-2	L2004V5	E1-2	L4006D5	E1-4	L6006L5	E1-4	Q2008DH4	E4-2

Part Number Index

TECCOR PART NO.	PAGE NO.	TECCOR PART NO.	PAGE NO.	TECCOR PART NO.	PAGE NO.	TECCOR PART NO.	PAGE NO.	TECCOR PART NO.	PAGE NO.
Q2008F41	E2-2	Q2040K7	E4-4	Q4010LT	E3-2	Q6004L4	E2-2	Q6015LT	E3-2
Q2008L4	E2-2	Q2N3	E2-2	Q4010LTH	E3-2	Q6004LT	E3-2	Q6015LTH	E3-2
Q2008LH4	E4-2	Q2N4	E2-2	Q4010N4	E2-4	Q6004V3	E2-2	Q6015N5	E2-4
Q2008LT	E3-2	Q2X3	E2-2	Q4010N5	E2-4	Q6004V4	E2-2	Q6015R5	E2-4
Q2008N4	E2-2	Q2X4	E2-2	Q4010NH5	E4-2	Q6006DH3	E4-2	Q6016LH3	E4-4
Q2008NH4	E4-2	Q2X8E3	E2-2	Q4010R4	E2-4	Q6006DH4	E4-2	Q6016LH4	E4-4
Q2008R4	E2-2	Q2X8E4	E2-2	Q4010R5	E2-4	Q6006F51	E2-2	Q6016LH6	E4-4
Q2008RH4	E4-2	Q4004D3	E2-2	Q4010RH5	E4-2	Q6006L5	E2-2	Q6016RH3	E4-4
Q2008VH3	E4-2	Q4004D4	E2-2	Q4012LH5	E4-2	Q6006LH4	E4-2	Q6016RH4	E4-4
Q2008VH4	E4-2	Q4004F31	E2-2	Q4012NH5	E4-2	Q6006LT	E3-2	Q6016RH6	E4-4
Q2010F51	E2-4	Q4004F41	E2-2	Q4012RH5	E4-2	Q6006LTH	E3-2	Q601E3	E2-2
Q2010L4	E2-4	Q4004L3	E2-2	Q4015L5	E2-4	Q6006N5	E2-2	Q601E4	E2-2
Q2010L5	E2-4	Q4004L4	E2-2	Q4015LT	E3-2	Q6006NH4	E4-2	Q6025J6	E4-4
Q2010LH5	E4-2	Q4004LT	E3-2	Q4015LTH	E3-2	Q6006R5	E2-2	Q6025K6	E4-4
Q2010LT	E3-2	Q4004V3	E2-2	Q4015N5	E2-4	Q6006RH4	E4-2	Q6025L6	E4-4
Q2010N4	E2-4	Q4004V4	E2-2	Q4015R5	E2-4	Q6006VH3	E4-2	Q6025N5	E2-4
Q2010N5	E2-4	Q4006DH3	E4-2	Q4016LH3	E4-4	Q6006VH4	E4-2	Q6025P5	E2-4
Q2010NH5	E4-2	Q4006DH4	E4-2	Q4016LH4	E4-4	Q6008DH3	E4-2	Q6025R5	E2-4
Q2010R4	E2-4	Q4006F41	E2-2	Q4016LH6	E4-4	Q6008DH4	E4-2	Q6025R6	E4-4
Q2010R5	E2-4	Q4006L4	E2-2	Q4016RH3	E4-4	Q6008F51	E2-2	Q6030LH5	E4-4
Q2010RH5	E4-2	Q4006LH4	E4-2	Q4016RH4	E4-4	Q6008L5	E2-2	Q6035NH5	E4-4
Q2012LH5	E4-2	Q4006LT	E3-2	Q4016RH6	E4-4	Q6008LH4	E4-2	Q6035P5	E2-4
Q2012NH5	E4-2	Q4006LTH	E3-2	Q401E3	E2-2	Q6008LT	E3-2	Q6035RH5	E4-4
Q2012RH5	E4-2	Q4006N4	E2-2	Q401E4	E2-2	Q6008LTH	E3-2	Q6040J7	E4-4
Q2015L5	E2-4	Q4006NH4	E4-2	Q4025J6	E4-4	Q6008N5	E2-2	Q6040K7	E4-4
Q2015LT	E3-2	Q4006R4	E2-2	Q4025K6	E4-4	Q6008NH4	E4-2	Q6N3	E2-2
Q2015N5	E2-4	Q4006RH4	E4-2	Q4025L6	E4-4	Q6008R5	E2-2	Q6N4	E2-2
Q2015R5	E2-4	Q4006VH3	E4-2	Q4025N5	E2-4	Q6008RH4	E4-2	Q6X3	E2-2
Q2016LH3	E4-4	Q4006VH4	E4-2	Q4025R5	E2-4	Q6008VH3	E4-2	Q6X4	E2-2
Q2016LH4	E4-4	Q4008DH3	E4-2	Q4025R6	E4-4	Q6008VH4	E4-2	Q6X8E3	E2-2
Q2016LH6	E4-4	Q4008DH4	E4-2	Q4030LH5	E4-4	Q6010F51	E2-4	Q6X8E4	E2-2
Q2016RH3	E4-4	Q4008F41	E2-2	Q4035NH5	E4-4	Q6010L4	E2-4	Q8004D4	E2-2
Q2016RH4	E4-4	Q4008L4	E2-2	Q4035RH5	E4-4	Q6010L5	E2-4	Q8004L4	E2-2
Q2016RH6	E4-4	Q4008LH4	E4-2	Q4040J7	E4-4	Q6010LH5	E4-2	Q8004V4	E2-2
Q201E3	E2-2	Q4008LT	E3-2	Q4040K7	E4-4	Q6010LT	E3-2	Q8006DH3	E4-2
Q201E4	E2-2	Q4008LTH	E3-2	Q4N3	E2-2	Q6010LTH	E3-2	Q8006DH4	E4-2
Q2025J6	E4-4	Q4008N4	E2-2	Q4N4	E2-2	Q6010N4	E2-4	Q8006L5	E2-2
Q2025K6	E4-4	Q4008NH4	E4-2	Q4X3	E2-2	Q6010N5	E2-4	Q8006LH4	E4-2
Q2025L6	E4-4	Q4008R4	E2-2	Q4X4	E2-2	Q6010NH5	E4-2	Q8006N5	E2-2
Q2025N5	E2-4	Q4008RH4	E4-2	Q4X8E3	E2-2	Q6010R4	E2-4	Q8006NH4	E4-2
Q2025R5	E2-4	Q4008VH3	E4-2	Q4X8E4	E2-2	Q6010R5	E2-4	Q8006R5	E2-2
Q2025R6	E4-4	Q4008VH4	E4-2	Q6004D3	E2-2	Q6010RH5	E4-2	Q8006RH4	E4-2
Q2030LH5	E4-4	Q4010F51	E2-4	Q6004D4	E2-2	Q6012LH5	E4-2	Q8006VH3	E4-2
Q2035NH5	E4-4	Q4010L4	E2-4	Q6004F31	E2-2	Q6012NH5	E4-2	Q8006VH4	E4-2
Q2035RH5	E4-4	Q4010L5	E2-4	Q6004F41	E2-2	Q6012RH5	E4-2	Q8008DH3	E4-2
Q2040J7	E4-4	Q4010LH5	E4-2	Q6004L3	E2-2	Q6015L5	E2-4	Q8008DH4	E4-2

Part Number Index

TECCOR PART NO.	PAGE NO.	TECCOR PART NO.	PAGE NO.	TECCOR PART NO.	PAGE NO.	TECCOR PART NO.	PAGE NO.	TECCOR PART NO.	PAGE NO.
Q8008L5	E2-2	QK006N5	E2-2	QK040K7	E4-4	S2015L	E6-4	S4008L	E6-2
Q8008LH4	E4-2	QK006NH4	E4-2	S2004DS1	E5-2	S2016N	E6-4	S4008LS2	E5-4
Q8008N5	E2-2	QK006R5	E2-2	S2004DS2	E5-2	S2016R	E6-4	S4008LS3	E5-4
Q8008NH4	E4-2	QK006RH4	E4-2	S2004VS1	E5-2	S201E	E6-2	S4008R	E6-2
Q8008R5	E2-2	QK006VH3	E4-2	S2004VS2	E5-2	S2020L	E6-4	S4008V	E6-2
Q8008RH4	E4-2	QK006VH4	E4-2	S2006D	E6-2	S2025L	E6-4	S4008VS2	E5-4
Q8008VH3	E4-2	QK008DH3	E4-2	S2006DS2	E5-4	S2025N	E6-4	S4008VS3	E5-4
Q8008VH4	E4-2	QK008DH4	E4-2	S2006DS3	E5-4	S2025R	E6-4	S4010D	E6-2
Q8010L4	E2-4	QK008L5	E2-2	S2006F1	E6-2	S2035J	E6-4	S4010DS2	E5-4
Q8010L5	E2-4	QK008LH4	E4-2	S2006FS21	E5-4	S2035K	E6-4	S4010DS3	E5-4
Q8010LH5	E4-2	QK008N5	E2-2	S2006FS31	E5-4	S2040N	E6-4	S4010F1	E6-2
Q8010N4	E2-4	QK008NH4	E4-2	S2006L	E6-2	S2040R	E6-4	S4010FS21	E5-4
Q8010N5	E2-4	QK008R5	E2-2	S2006LS2	E5-4	S2055M	E6-4	S4010FS31	E5-4
Q8010NH5	E4-2	QK008RH4	E4-2	S2006LS3	E5-4	S2055N	E6-4	S4010L	E6-2
Q8010R4	E2-4	QK008VH3	E4-2	S2006V	E6-2	S2055R	E6-4	S4010LS2	E5-4
Q8010R5	E2-4	QK008VH4	E4-2	S2006VS2	E5-4	S2055W	E6-4	S4010LS3	E5-4
Q8010RH5	E4-2	QK010L4	E2-4	S2006VS3	E5-4	S2065J	E6-4	S4010R	E6-2
Q8012LH5	E4-2	QK010L5	E2-4	S2008D	E6-2	S2065K	E6-4	S4010V	E6-2
Q8012NH5	E4-2	QK010LH5	E4-2	S2008DS2	E5-4	S2070W	E6-4	S4010VS2	E5-4
Q8012RH5	E4-2	QK010N4	E2-4	S2008DS3	E5-4	S2N1	E6-2	S4010VS3	E5-4
Q8015L5	E2-4	QK010N5	E2-4	S2008F1	E6-2	S2S	E5-2	S4012D	E6-2
Q8015N5	E2-4	QK010NH5	E4-2	S2008FS21	E5-4	S2S1	E5-2	S4012R	E6-2
Q8015R5	E2-4	QK010R4	E2-4	S2008FS31	E5-4	S2S2	E5-2	S4012V	E6-2
Q8016LH3	E4-4	QK010R5	E2-4	S2008L	E6-2	S2S3	E5-2	S4015L	E6-4
Q8016LH4	E4-4	QK010RH5	E4-2	S2008LS2	E5-4	S4004DS1	E5-2	S4016N	E6-4
Q8016LH6	E4-4	QK012LH5	E4-2	S2008LS3	E5-4	S4004DS2	E5-2	S4016R	E6-4
Q8016RH3	E4-4	QK012NH5	E4-2	S2008R	E6-2	S4004VS1	E5-2	S401E	E6-2
Q8016RH4	E4-4	QK012RH5	E4-2	S2008V	E6-2	S4004VS2	E5-2	S4020L	E6-4
Q8016RH6	E4-4	QK015L5	E2-4	S2008VS2	E5-4	S4006D	E6-2	S4025L	E6-4
Q8025J6	E4-4	QK015N5	E2-4	S2008VS3	E5-4	S4006DS2	E5-4	S4025N	E6-4
Q8025K6	E4-4	QK015R5	E2-4	S2010D	E6-2	S4006DS3	E5-4	S4025R	E6-4
Q8025L6	E4-4	QK016LH3	E4-4	S2010DS2	E5-4	S4006F1	E6-2	S4035J	E6-4
Q8025N5	E2-4	QK016LH4	E4-4	S2010DS3	E5-4	S4006FS21	E5-4	S4035K	E6-4
Q8025P5	E2-4	QK016LH6	E4-4	S2010F1	E6-2	S4006FS31	E5-4	S4040N	E6-4
Q8025R5	E2-4	QK016NH3	E4-4	S2010FS21	E5-4	S4006L	E6-2	S4040R	E6-4
Q8025R6	E4-4	QK016NH4	E4-4	S2010FS31	E5-4	S4006LS2	E5-4	S4055M	E6-4
Q8035P5	E2-4	QK016NH6	E4-4	S2010L	E6-2	S4006LS3	E5-4	S4055N	E6-4
Q8040J7	E4-4	QK016RH3	E4-4	S2010LS2	E5-4	S4006V	E6-2	S4055R	E6-4
Q8040K7	E4-4	QK016RH4	E4-4	S2010LS3	E5-4	S4006VS2	E5-4	S4055W	E6-4
QK004D4	E2-2	QK016RH6	E4-4	S2010R	E6-2	S4006VS3	E5-4	S4065J	E6-4
QK004L4	E2-2	QK025K6	E4-4	S2010V	E6-2	S4008D	E6-2	S4065K	E6-4
QK004V4	E2-2	QK025L6	E4-4	S2010VS2	E5-4	S4008DS2	E5-4	S4070W	E6-4
QK006DH3	E4-2	QK025N5	E2-4	S2010VS3	E5-4	S4008DS3	E5-4	S4N1	E6-2
QK006DH4	E4-2	QK025N6	E4-4	S2012D	E6-2	S4008F1	E6-2	S4S	E5-2
QK006L5	E2-2	QK025R5	E2-4	S2012R	E6-2	S4008FS21	E5-4	S4S1	E5-2
QK006LH4	E4-2	QK025R6	E4-4	S2012V	E6-2	S4008FS31	E5-4	S4S2	E5-2

Part Number Index

TECCOR PART NO.	PAGE NO.	TECCOR PART NO.	PAGE NO.	TECCOR PART NO.	PAGE NO.	TECCOR PART NO.	PAGE NO.	TECCOR PART NO.	PAGE NO.
S4S3	E5-2	S6015L	E6-4	S8035K	E6-4	T106D1	E5-2		
S6004DS1	E5-2	S6016N	E6-4	S8040N	E6-4	T106M1	E5-2		
S6004DS2	E5-2	S6016R	E6-4	S8040R	E6-4	T107B1	E5-2		
S6004VS1	E5-2	S601E	E6-2	S8055M	E6-4	T107D1	E5-2		
S6004VS2	E5-2	S6020L	E6-4	S8055N	E6-4	T107M1	E5-2		
S6006D	E6-2	S6025L	E6-4	S8055R	E6-4	TCR22-4	E5-2		
S6006DS2	E5-4	S6025N	E6-4	S8055W	E6-4	TCR22-6	E5-2		
S6006DS3	E5-4	S6025R	E6-4	S8065J	E6-4	TCR22-8	E5-2		
S6006F1	E6-2	S6035J	E6-4	S8065K	E6-4				
S6006FS21	E5-4	S6035K	E6-4	S8070W	E6-4				
S6006FS31	E5-4	S6040N	E6-4	SK006D	E6-2				
S6006L	E6-2	S6040R	E6-4	SK006L	E6-2				
S6006LS2	E5-4	S6055M	E6-4	SK006V	E6-2				
S6006LS3	E5-4	S6055N	E6-4	SK008D	E6-2				
S6006V	E6-2	S6055R	E6-4	SK008L	E6-2				
S6006VS2	E5-4	S6055W	E6-4	SK008R	E6-2				
S6006VS3	E5-4	S6065J	E6-4	SK008V	E6-2				
S6008D	E6-2	S6065K	E6-4	SK010D	E6-2				
S6008DS2	E5-4	S6070W	E6-4	SK010L	E6-2				
S6008DS3	E5-4	S6N1	E6-2	SK010R	E6-2				
S6008F1	E6-2	S6S	E5-2	SK010V	E6-2				
S6008FS21	E5-4	S6S1	E5-2	SK012D	E6-2				
S6008FS31	E5-4	S6S2	E5-2	SK012R	E6-2				
S6008L	E6-2	S6S3	E5-2	SK012V	E6-2				
S6008LS2	E5-4	S8006D	E6-2	SK015L	E6-4				
S6008LS3	E5-4	S8006L	E6-2	SK016N	E6-4				
S6008R	E6-2	S8006V	E6-2	SK016R	E6-4				
S6008V	E6-2	S8008D	E6-2	SK020L	E6-4				
S6008VS2	E5-4	S8008L	E6-2	SK025L	E6-4				
S6008VS3	E5-4	S8008R	E6-2	SK025N	E6-4				
S6010D	E6-2	S8008V	E6-2	SK025R	E6-4				
S6010DS2	E5-4	S8010D	E6-2	SK035K	E6-4				
S6010DS3	E5-4	S8010L	E6-2	SK040N	E6-4				
S6010F1	E6-2	S8010R	E6-2	SK040R	E6-4				
S6010FS21	E5-4	S8010V	E6-2	SK055M	E6-4				
S6010FS31	E5-4	S8012D	E6-2	SK055N	E6-4				
S6010L	E6-2	S8012R	E6-2	SK055R	E6-4				
S6010LS2	E5-4	S8012V	E6-2	SK065K	E6-4				
S6010LS3	E5-4	S8015L	E6-4	ST-32	E8-2				
S6010R	E6-2	S8016N	E6-4	ST-32B	E8-2				
S6010V	E6-2	S8016R	E6-4	ST-34B	E8-2				
S6010VS2	E5-4	S8020L	E6-4	ST-35	E8-2				
S6010VS3	E5-4	S8025L	E6-4	ST-36A	E8-2				
S6012D	E6-2	S8025N	E6-4	ST-36B	E8-2				
S6012R	E6-2	S8025R	E6-4	ST-40	E8-2				
S6012V	E6-2	S8035J	E6-4	T106B1	E5-2				

