

RECTIFIERS

Military Approved, 5 Amp,
General Purpose

1N5550-1N5553
JAN, JANTX & JANTXV

FEATURES

- Qualified to MIL-S-19500/420A
- Continuous Rating: 5A
- PIV: to 800V
- TX Parts 100% Screened
- Miniature Size
- Controlled Avalanche

DESCRIPTION

This series of military approved rectifiers is useful in many military applications. The 100% screening requirements in the "TX" version combined with the unique Microsemi construction assures the highest degree of reliability.

ABSOLUTE MAXIMUM RATINGS

Peak Inverse Voltage	Type
200V	JAN, JANTX & JANTXV 1N5550
400V	JAN, JANTX & JANTXV 1N5551
600V	JAN, JANTX & JANTXV 1N5552
800V	JAN, JANTX & JANTXV 1N5553

Maximum Average D.C. Output Current

@ $T_A = 55^\circ\text{C}$ 3.0A

@ $T_L = 55^\circ\text{C}$ 5.0A

Non-Repetitive Sinusoidal

Surge Current (8.3ms) 100A

Operating Temperature Range -65°C to $+175^\circ\text{C}$

Storage Temperature Range -65°C to $+200^\circ\text{C}$

Thermal Resistance See Lead Temperature Derating Curve

MECHANICAL SPECIFICATIONS

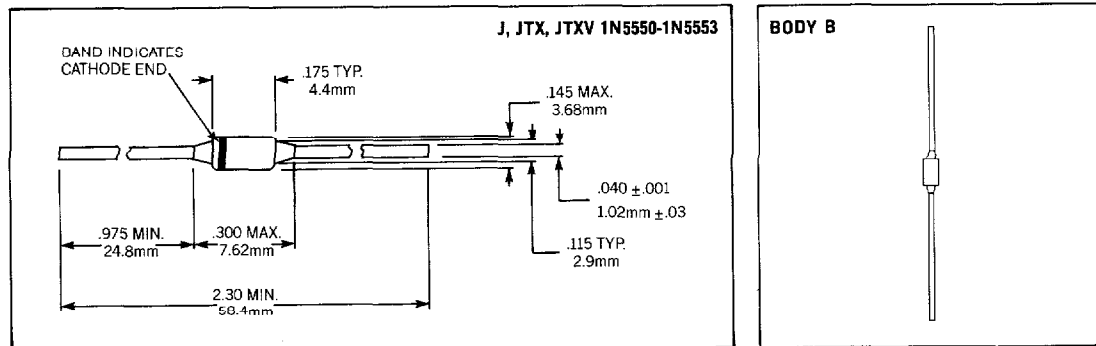

THESE DEVICES ALSO AVAILABLE IN SURFACE MOUNT PACKAGE. SEE SECTION 10

Microsemi Corp.
Watertown
The diode experts

ELECTRICAL SPECIFICATIONS (at 25°C unless noted)

Type	Peak Inverse Voltage	Minimum Reverse Breakdown Voltage @ 50µA	Peak Forward Voltage		Maximum Leakage Current @ PIV		Maximum Reverse Recovery Time*
			Min.	Max.	25°C	100°C	
J, JTX, JTXV 1N5550	200V	210V	0.6V @ I _F = 9A(pk) (8.3ms)	1.2V	1.0µA	75µA	2.0µs
J, JTX, JTXV 1N5551	400V	460V					
J, JTX, JTXV 1N5552	600V	660V					
J, JTX, JTXV 1N5553	800V	880V					

*Measured in a test circuit I_F = 0.5A, I_R = 1.0A, I_{REC} = 0.25A

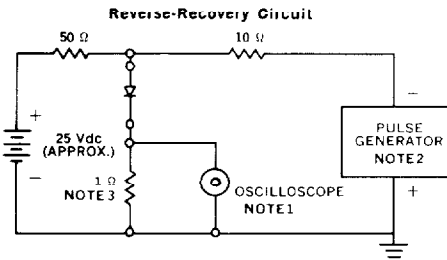
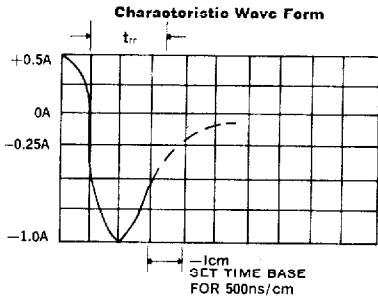
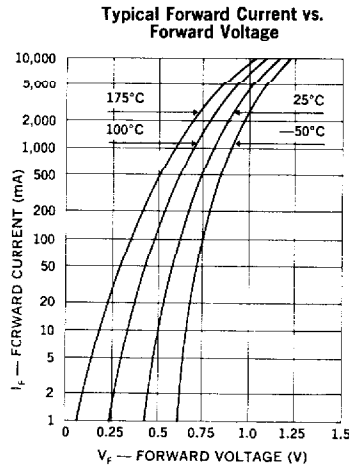
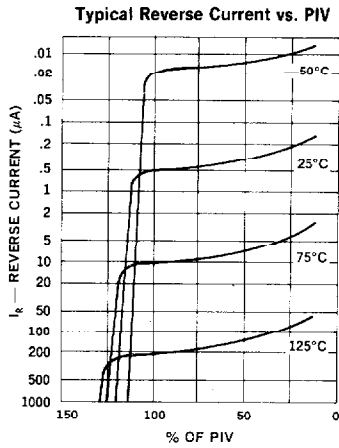
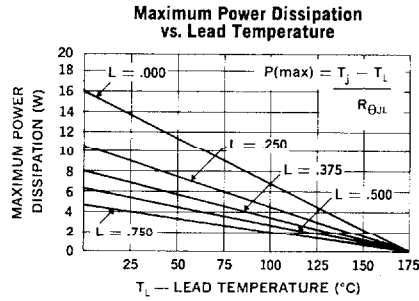
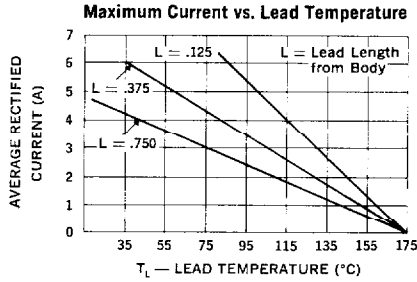

- NOTES:**
- Oscilloscope: Rise time ≤ 3ns; input impedance = 50Ω.
 - Pulse Generator: Rise time ≤ 8ns; source impedance 10Ω.
 - Current viewing resistor, non-inductive, coaxial recommended.