

**DESCRIPTION**

The LX5506B is a power amplifier optimized for the FCC Unlicensed National Information Infrastructure (U-NII) band, HyperLAN2 and Japan WLAN applications in the 4.9-5.85 GHz frequency range. The PA is implemented as a three-stage monolithic microwave integrated circuit (MMIC) with active bias, on-chip input matching and output pre-matching. It also features an on-chip output power detector to help reduce BOM cost and PCB board space for system implementations. The device is manufactured with an InGaP/GaAs Heterojunction Bipolar Transistor (HBT) IC process (MOCVD). It operates with a single positive voltage

supply of 3.3V (nominal), with +26dBm of P1dB and up to 25dB power gain in the 5.15 - 5.85GHz frequency range with a simple output matching capacitor pair.

LX5506B is available in a 16-pin 3mmx3mm micro-lead package (MLP). The compact footprint, low profile, and excellent thermal capability of the MLP package makes the LX5506B an ideal solution for broadband, high-gain power amplifier requirements for IEEE 802.11a, and HiperLAN2 portable WLAN applications.

**IMPORTANT:** For the most current data, consult MICROSEMI's website: <http://www.microsemi.com>

**KEY FEATURES**

- Advanced InGaP HBT
- Single-Polarity Voltage Supply
- EVM ~ 2.5% at Pout=+18dBm, 64QAM/ 54Mbps OFDM (3.3V)
- Power Gain ~ 25dB at 5.25GHz & Pout=+18dBm
- Power Gain ~ 21dB at 5.85GHz & Pout=+18dBm
- P1dB ~ +26dBm across 5.15 – 5.85 GHz
- Total Current ~ 170mA for Pout=+18dBm at 5.25GHz
- Total Current ~ 200mA for Pout=+20dBm at 5.25GHz
- ACPR ~ -48dBc at 30MHz Offset at Pout=+18dBm
- Integrated Power Detector
- Complete On-Chip Input Match
- Simple Output Capacitor Match
- Small Footprint: 3x3mm<sup>2</sup>
- Low Profile: 0.9mm

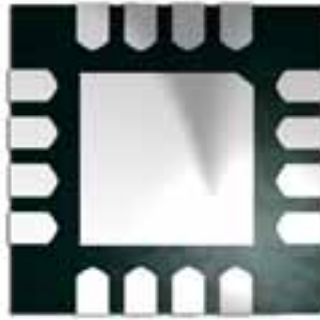
**PRODUCT HIGHLIGHT**

**APPLICATIONS/BENEFITS**

- FCC U-N11 Wireless
- IEEE 802.11a
- HiperLAN2

**PACKAGE ORDER INFO**
**LQ**
**Plastic MLPQ  
16-Pin**

RoHS Compliant / Pb-free

**LX5506BLQ**

Note: Available in Tape & Reel. Append the letters "TR" to the part number. (i.e. LX5506BLQ-TR)

This device is classified as ESD Level 0 in accordance with MIL-STD-883, Method 3015 (HBM) testing. Appropriate ESD procedures should be observed when handling this device.

**ABSOLUTE MAXIMUM RATINGS**

DC Supply Voltage, RF Off.....	6V
Collector Current .....	500mA
Total Power Dissipation.....	3W
RF Input Power .....	15dBm
Thermal Resistance (Junction-to-Case, $\theta_{JC}$ ).....	6°C/W
Maximum Junction Temperature ( $T_J$ max) .....	150°C
Operation Ambient Temperature .....	-40 to +85°C
Storage Temperature.....	-65 to 150°C
Package Peak Temp for Solder Reflow (40 Seconds Maximum Exposure). 260°C (+0, -5)	

Note: Exceeding these ratings could cause damage to the device. All voltages are with respect to Ground. Currents are positive into, negative out of specified terminal.

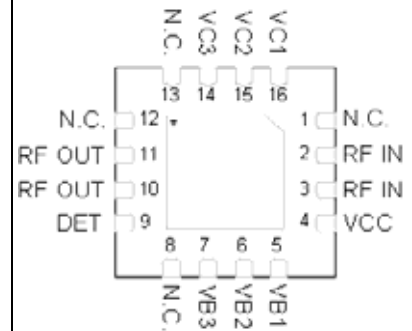
**PACKAGE PIN OUT**

\* Pad is Ground

**LQ PACKAGE**  
(Bottom View)

RoHS / Pb-free 100% Matte Tin Lead Finish

**FUNCTIONAL PIN DESCRIPTION**

Name	Pin #	Description
RF IN	2, 3	RF input for the power amplifier. This pin is DC-shorted to GND but AC-coupled to the transistor base of the first stage.
VCC	4	Supply voltage for the bias reference and control circuits. This pin can be combined with VC1, VC2 and VC3 pins, resulting in a single supply voltage (referred to as Vc).
VB1 VB2 VB3	5 6 7	Bias control voltage for the first stage. Bias control voltage for the second stage. Bias control voltage for the third stage.
DET	9	Detector output for the third stage PA output power.
RF OUT	10, 11	RF output for the power amplifier. This pin is DC-blocked from the collector of the output stage.
VC1 VC2 VC3	16 15 14	DC supply voltage for the first stage amplifier. DC supply voltage for the second stage amplifier. DC supply voltage for the third stage amplifier.
GND	Center Metal	The center metal base of the MLP package provides both DC/RF ground as well as heat sink for the power amplifier.
NC	1, 8, 12,13	These pins are unused and not connected to the device inside the package. They can be treated either as open (floating) pins, or connected to ground metal.

**ELECTRICAL CHARACTERISTICS**

Unless otherwise specified, the following specifications apply over the following test conditions:  $V_c = 3.3V$ ,  $V_{ref} = 2.9V$ ,  $I_{cq} = 90mA$ , and  $T_A = 25^\circ C$

PARAMETER	CONDITION	SYMBOL	MIN.	TYP.	MAX.	MIN.	TYP.	MAX.	UNIT
Frequency Range		f	5.15		5.35	5.7		5.85	GHz
Output Power at 1dB Compression		P <sub>out</sub>	25	26		25	26		dBm
Power Gain at P <sub>out</sub> =+18dBm		G <sub>p</sub>		25			21		dB
EVM at P <sub>out</sub> =+18dBm	64QAM/54Mbps			2.5			3		%
Total Current at P <sub>out</sub> =+18dBm		I <sub>c_total</sub>		170			180		mA
Quiescent Current		I <sub>cq</sub>		90			90		mA
Bias Control Reference Current	For I <sub>cq</sub> =90mA	I <sub>ref</sub>		4.2			4.2		mA
Small-Signal Gain		S <sub>21</sub>		24			20		dB
Gain Flatness	Over 200MHz	ΔS <sub>21</sub>		+/-0.5			+/-0.5		dB
Gain Variation Over Temperature	-40 to +85°C	ΔS <sub>21</sub>		+/-1			+/-0.5		dB
Input Return Loss		S <sub>11</sub>		-15			-10		dB
Output Return Loss		S <sub>22</sub>		-8			-10		dB
Reverse Isolation		S <sub>12</sub>		-40			-40		dB
Second Harmonic	P <sub>out</sub> = +18dBm			-40			-40		dBc
Third Harmonic	P <sub>out</sub> = +18dBm			-40			-40		dBc
Detector Response	P <sub>out</sub> = +18dBm	DET		1.6			2.2		V
Ramp-On Time	10~90%	t <sub>ON</sub>		100			100		ns

Note: All measured data was obtained on a 10 mil GETEK evaluation board.

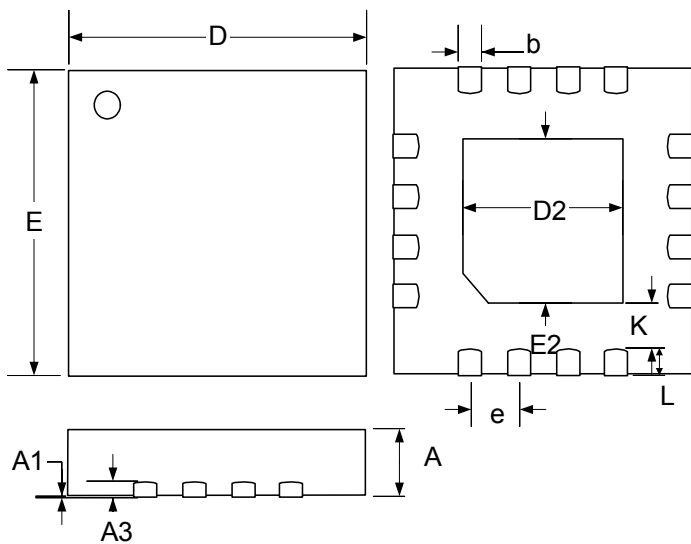
**PACKAGE DIMENSIONS**
**LQ 16-Pin MLPQ 3x3 (75 x 75 mil DAP)**

Dim	MILLIMETERS		INCHES	
	MIN	MAX	MIN	MAX
A	0.80	1.00	0.031	0.039
A1	0	0.05	0	0.002
A3	0.20 REF		0.008 REF	
b	0.18	0.30	0.007	0.012
D	3.00 BSC		0.118 BSC	
E	3.00 BSC		0.118 BSC	
e	0.50 BSC		0.020 BSC	
D2	1.55	1.80	0.061	0.071
E2	1.55	1.80	0.061	0.071
K	0.2	-	0.008	-
L	0.35	0.50	0.012	0.020

**Note:**

- Dimensions do not include mold flash or protrusions; these shall not exceed 0.155mm(.006") on any side. Lead dimension shall not include solder coverage.

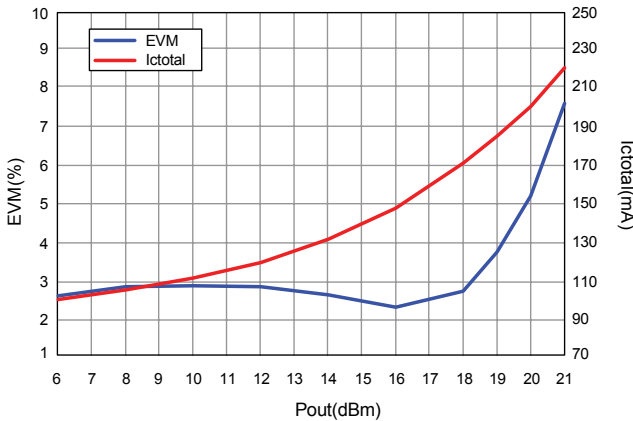
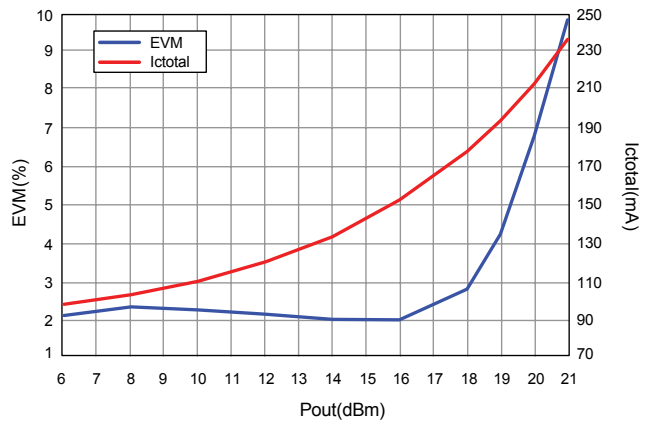
**EVM & CURRENT VS POUT @ 5.25GHZ**

**EVM & CURRENT VS POUT @ 5.85GHZ**

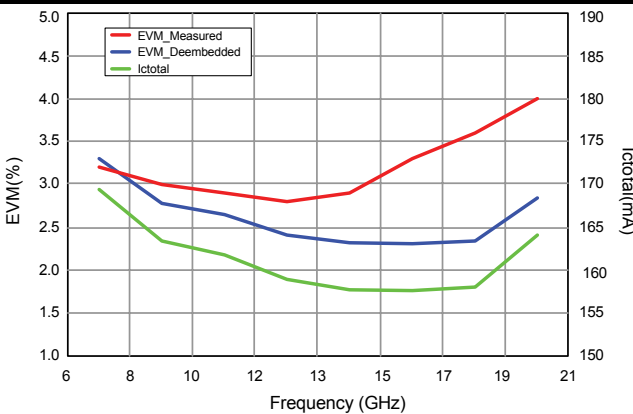
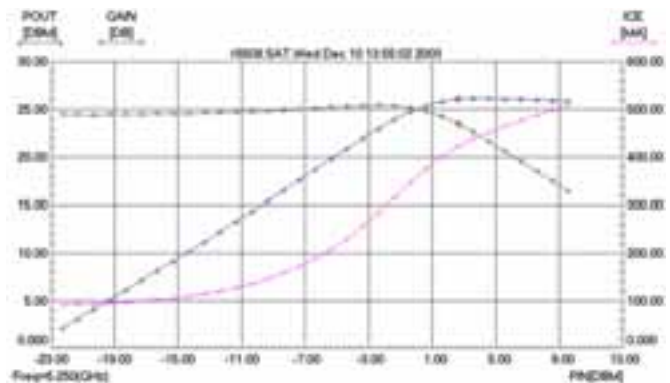
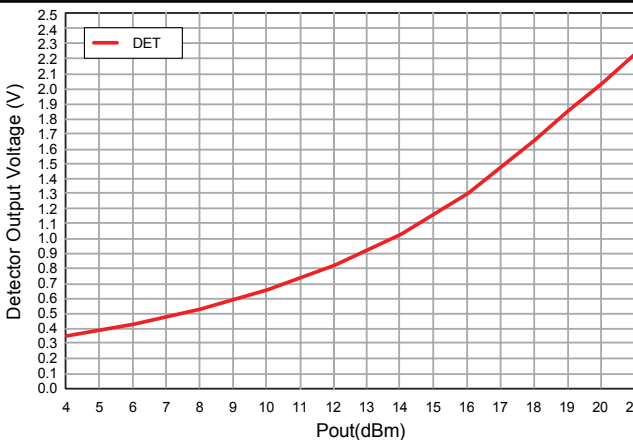
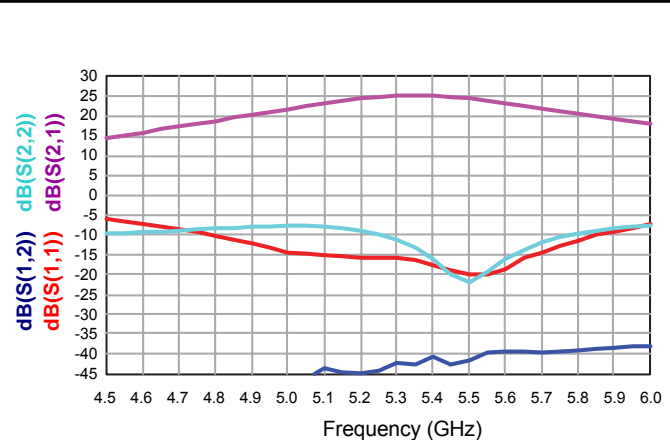
 $V_C = 3.3V, V_{REF} = 2.9V, I_{CQ} = 90mA, \text{Frequency} = 5.25GHz, 64QAM / 54 \text{ Mbps}$ 
 $V_C = 3.3V, V_{REF} = 2.9V, I_{CQ} = 90mA, \text{Frequency} = 5.85GHz, 64QAM / 54 \text{ Mbps}$ 

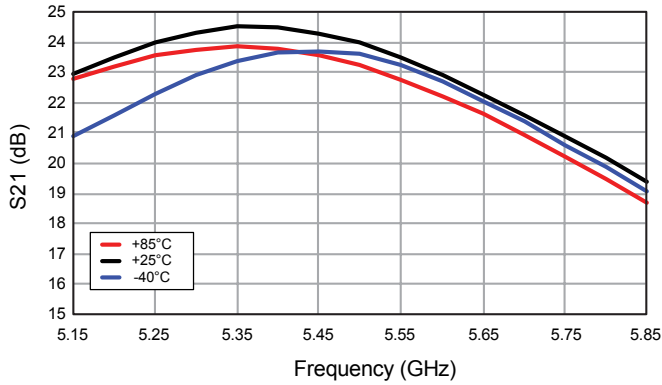
Note: All EVM data are for OFDM signal of 64QAM/54Mbps from Yokogawa VG6000, and are actual measured data without any de-embedding. Source EVM is 1.4 - 1.8% for input power levels for test

**EVM & CURRENT VS FREQUENCY**

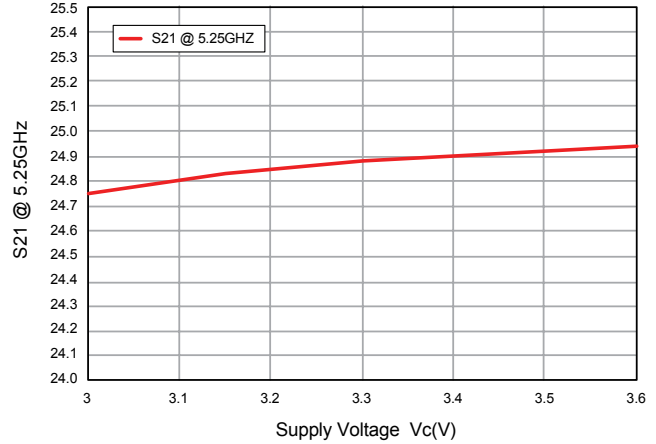
 $V_C = 3.3V, V_{REF} = 2.9V, I_{CQ} = 90mA, P_{OUT} = +18dBm, 64QAM / 54 \text{ Mbps}$ 
**TYPICAL POWER SWEEP @ 5.25GHZ**

 $V_C = 3.3V, V_{REF} = 2.9V, I_{CQ} = 90mA, \text{Frequency} = 5.25GHz, \text{CW Input}$ 
**TYPICAL POWER DETECT RESPONSE**

 $V_C = 3.3V, V_{REF} = 2.9V, I_{CQ} = 90mA, \text{Frequency} = 5.25GHz, 64QAM / 54 \text{ Mbps}$ 
**TYPICAL S-PARAMETER @ ROOM TEMP**

 $V_C = 3.3V, V_{REF} = 2.9V, I_{CQ} = 90mA$

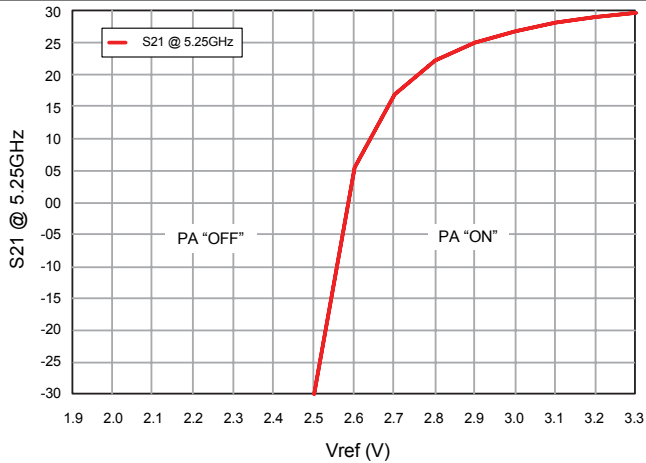
**SMALL SIGNAL GAIN OVER TEMP**

$V_C = 3.3V$ ,  $V_{REF} = 2.9V$ ,  $I_{CQ} = 90mA$  @ Room Temperature

**SMALL SIGNAL VS SUPPLY VOLTAGE**

$V_{REF} = 2.9V$ ,  $I_{CQ} = 90mA$  for Nominal  $V_C = 3.3V$

**SMALL SIGNAL VS. REF VOLTAGE**

$V_C = 3.3V$ ,  $I_{CQ} = 90mA$  for Nominal  $V_{REF} = 2.9V$

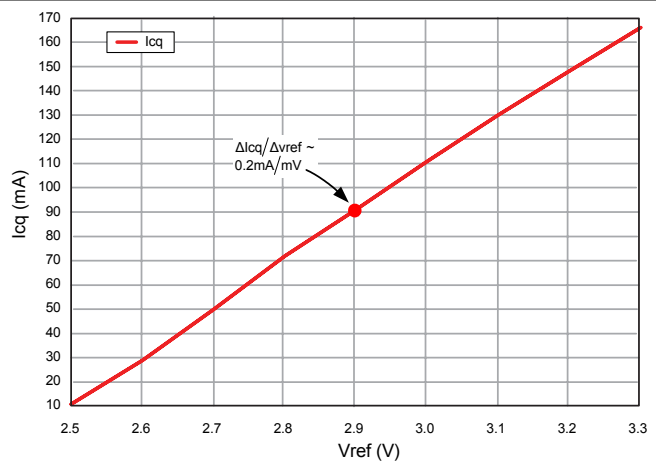
**QUESCENT CURRENT VS. REF VOLTAGE**

$V_C = 3.3V$ ,  $I_{CQ} = 90mA$  for Nominal  $V_{REF} = 2.9V$

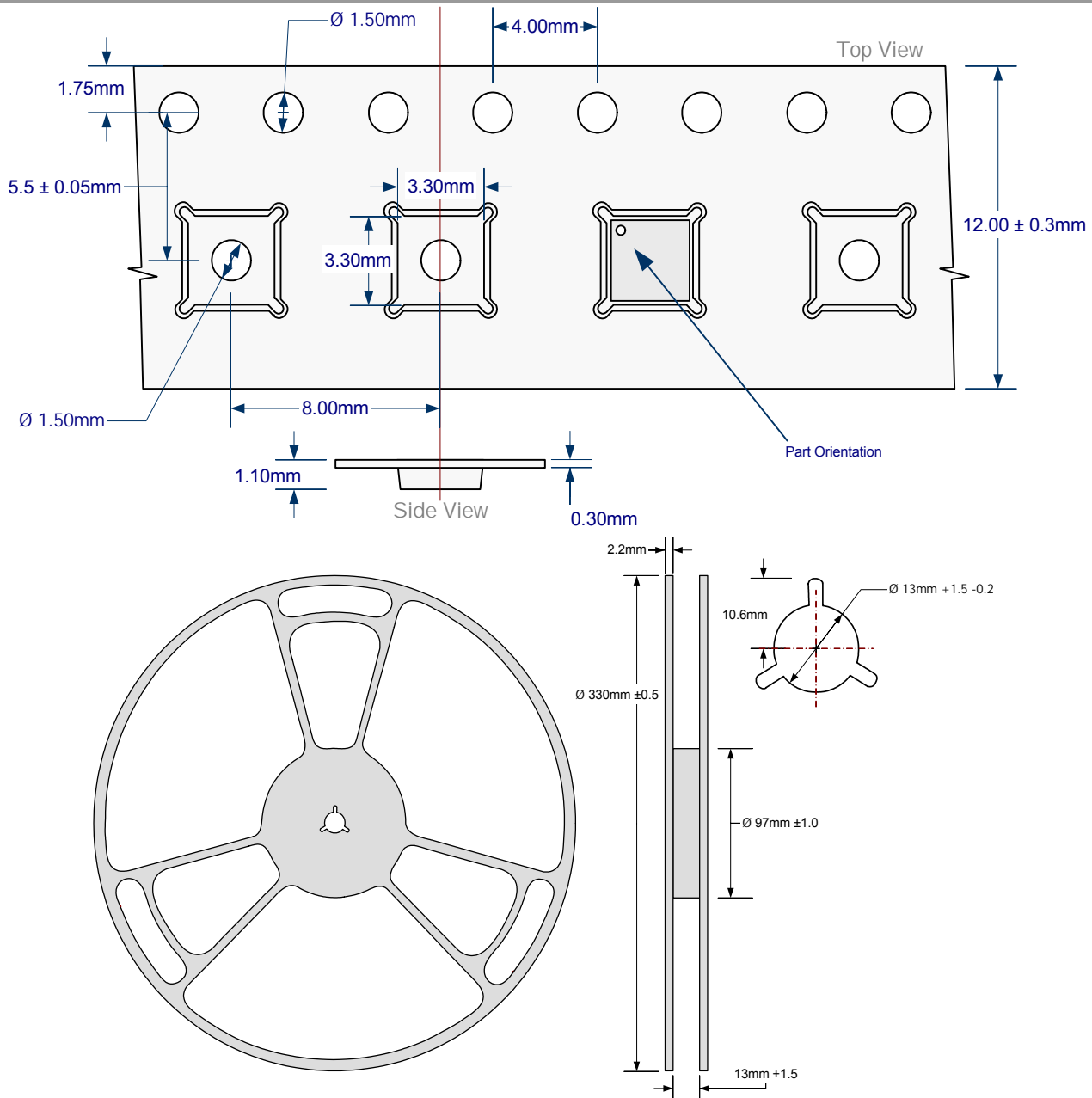
**TAPE AND REEL**
**Tape And Reel Specification**



**Microsemi**<sup>®</sup>

**LX5506B**

**InGaP HBT 4 – 6GHz Power Amplifier**

**PRODUCTION DATA SHEET**

**NOTES**

PRODUCTION DATA – Information contained in this document is proprietary to Microsemi and is current as of publication date. This document may not be modified in any way without the express written consent of Microsemi. Product processing does not necessarily include testing of all parameters. Microsemi reserves the right to change the configuration and performance of the product and to discontinue product at any time.