

MMBT3906

Features

- Surface Mount SOT-23 Package
- Capable of 350mWatts of Power Dissipation

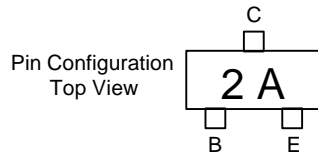

PNP General Purpose Amplifier

Electrical Characteristics @ 25°C Unless Otherwise Specified

Symbol	Parameter	Min	Max	Units
OFF CHARACTERISTICS				
$V_{(BR)CEO}$	Collector-Emitter Breakdown Voltage* ($I_C=1.0mA$, $I_B=0$)	40		Vdc
$V_{(BR)CBO}$	Collector-Base Breakdown Voltage ($I_C=10\mu A$, $I_E=0$)	40		Vdc
$V_{(BR)EBO}$	Emitter-Base Breakdown Voltage ($I_E=10\mu A$, $I_C=0$)	5.0		Vdc
I_{BL}	Base Cutoff Current ($V_{CE}=30Vdc$, $V_{BE}=3.0Vdc$)		50	nAdc
I_{CEX}	Collector Cutoff Current ($V_{CE}=30Vdc$, $V_{BE}=3.0Vdc$)		50	nAdc

ON CHARACTERISTICS

h_{FE}	DC Current Gain* ($I_C=0.1mA$, $V_{CE}=1.0Vdc$) ($I_C=1.0mA$, $V_{CE}=1.0Vdc$) ($I_C=10mA$, $V_{CE}=1.0Vdc$) ($I_C=50mA$, $V_{CE}=1.0Vdc$) ($I_C=100mA$, $V_{CE}=1.0Vdc$)	60 80 100 60 30	300	
$V_{CE(sat)}$	Collector-Emitter Saturation Voltage ($I_C=10mA$, $I_B=1.0mA$) ($I_C=50mA$, $I_B=5.0mA$)		0.25 0.4	Vdc
$V_{BE(sat)}$	Base-Emitter Saturation Voltage ($I_C=10mA$, $I_B=1.0mA$) ($I_C=50mA$, $I_B=5.0mA$)	0.65	0.85 0.95	Vdc

SMALL-SIGNAL CHARACTERISTICS

f_T	Current Gain-Bandwidth Product ($I_C=10mA$, $V_{CE}=20Vdc$, $f=100MHz$)	250		MHz
C_{obo}	Output Capacitance ($V_{CB}=5.0Vdc$, $I_E=0$, $f=100MHz$)		4.5	pF
C_{ibo}	Input Capacitance ($V_{BE}=0.5Vdc$, $I_C=0$, $f=100kHz$)		10.0	pF
NF	Noise Figure ($I_C=100\mu A$, $V_{CE}=5.0Vdc$, $R_S=1.0k\Omega$, $f=10Hz$ to $15.7kHz$)		4.0	dB

SWITCHING CHARACTERISTICS

t_d	Delay Time	($V_{CC}=3.0Vdc$, $V_{BE}=0.5Vdc$)	35	ns
t_r	Rise Time	($I_C=10mA$, $I_{B1}=1.0mA$)	35	ns
t_s	Storage Time	($V_{CC}=3.0Vdc$, $I_C=10mA$)	225	ns
t_f	Fall Time	($I_{B1}=I_{B2}=1.0mA$)	75	ns

*Pulse Width $\leq 300\mu s$, Duty Cycle $\leq 2.0\%$

SOT-23

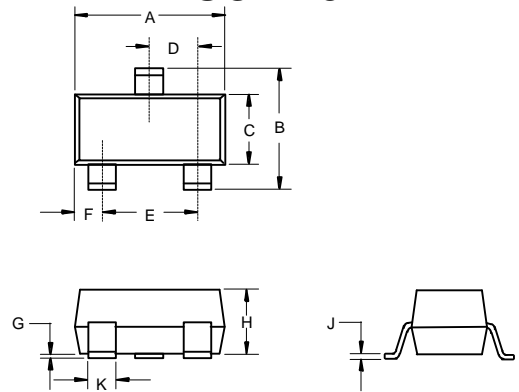

DIM	INCHES		MM		NOTE
	MIN	MAX	MIN	MAX	
A	.110	.120	2.80	3.04	
B	.083	.098	2.10	2.64	
C	.047	.055	1.20	1.40	
D	.035	.041	.89	1.03	
E	.070	.081	1.78	2.05	
F	.018	.024	.45	.60	
G	.0005	.0039	.013	.100	
H	.035	.044	.89	1.12	
J	.003	.007	.085	.180	
K	.015	.020	.37	.51	

Suggested Solder Pad Layout

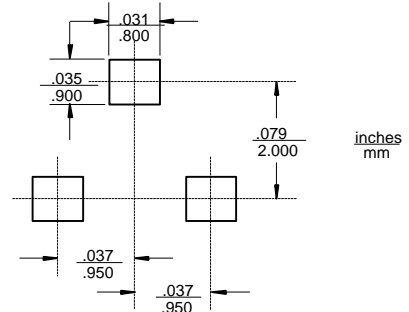

MMBT3906

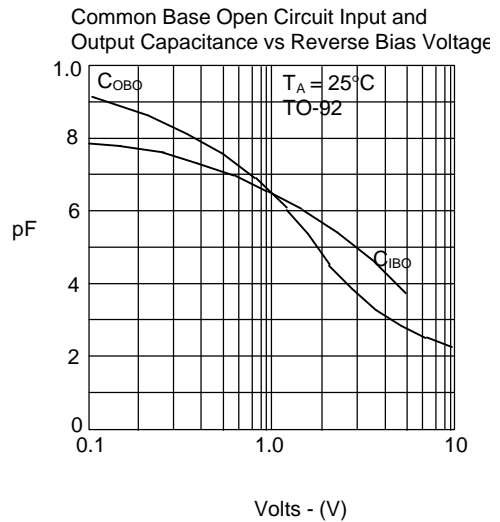
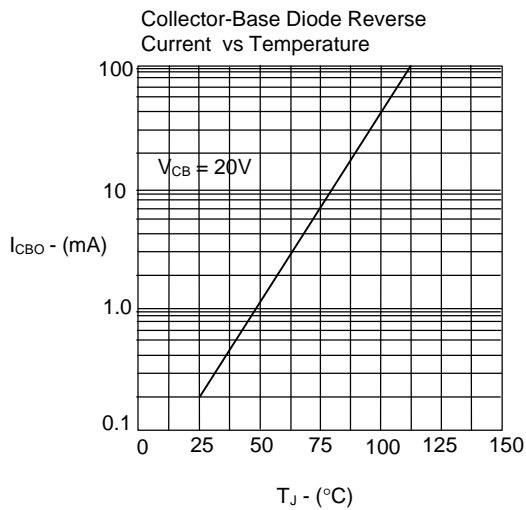
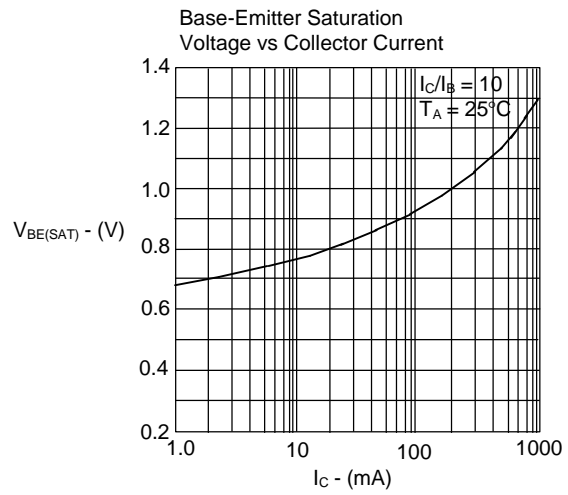
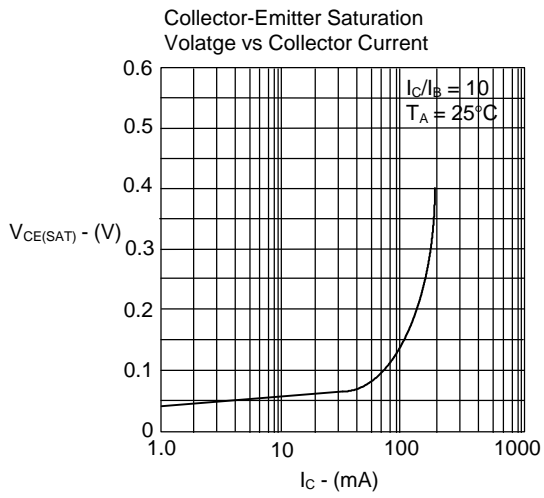
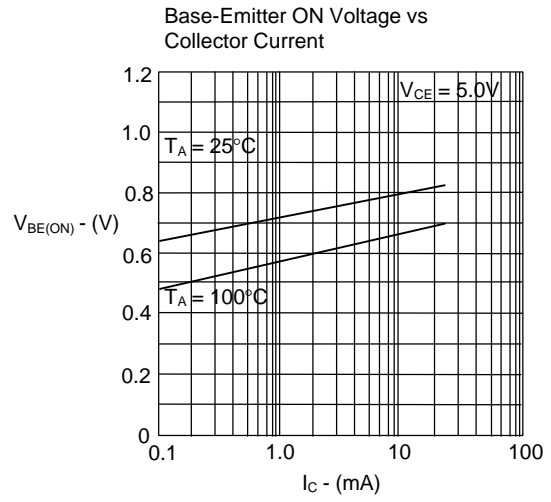
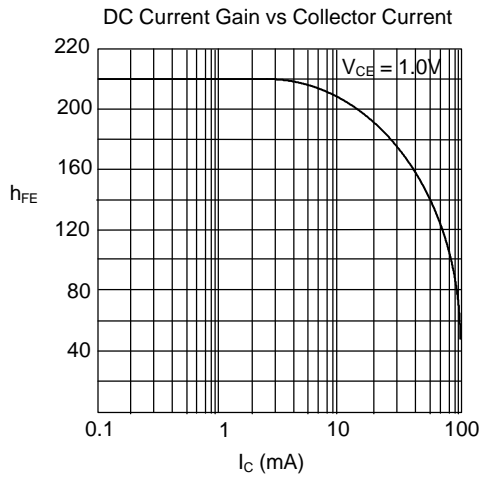

MMBT3906

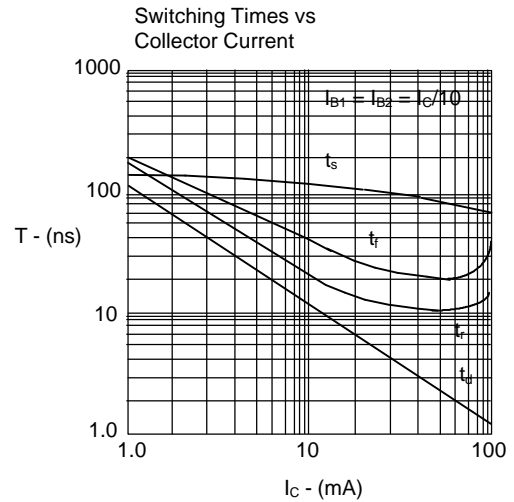
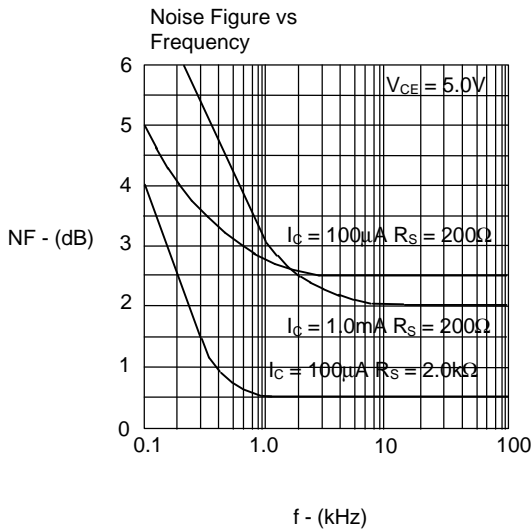
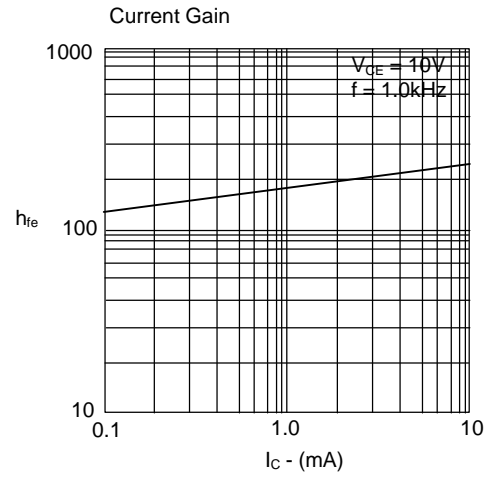
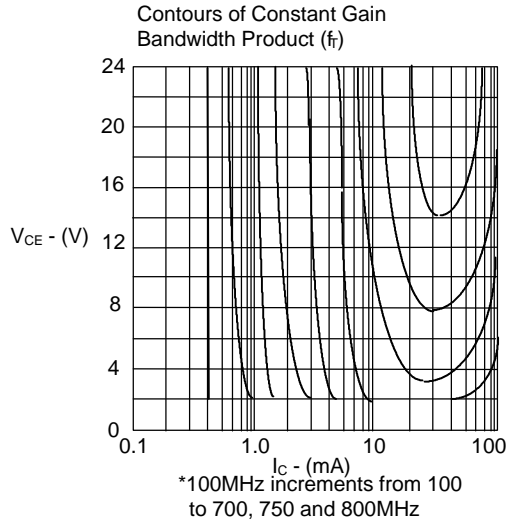
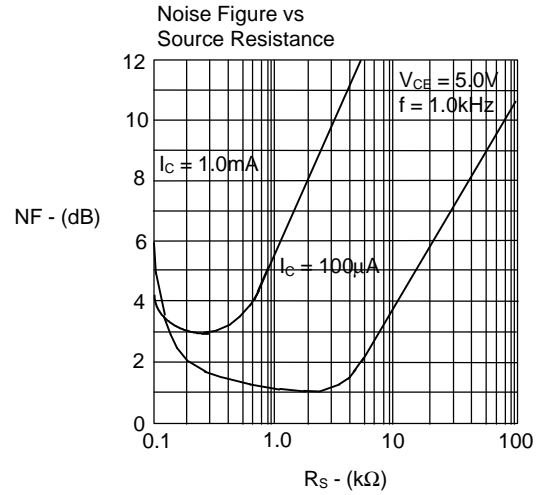
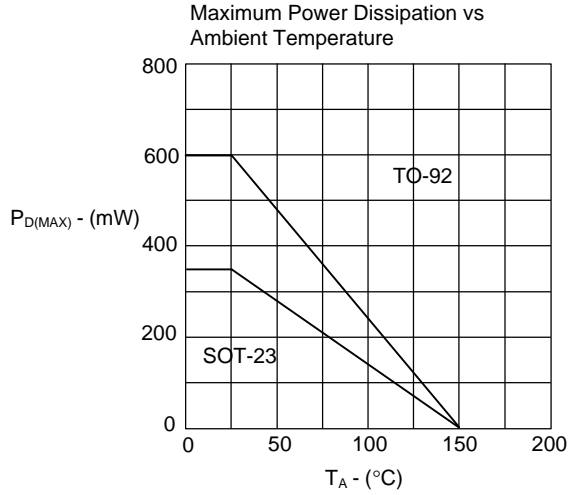

MMBT3906

