

FEATURES

- Very Low Forward Voltage (1.15V)
- Very Fast Recovery Times (50nSec)
- Small Size
- Convenient Package

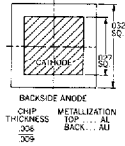

DESCRIPTION

The UES1104 series is specifically designed for operation in power switching circuits operating at frequencies of at least 20 KHz.

ABSOLUTE MAXIMUM RATINGS

Peak Inverse Voltage, UES1104	200V
Peak Inverse Voltage, UES1105	300V
Peak Inverse Voltage, UES1106	400V
Maximum Average DC Output Current, I_O		
@ $T_A = 25^\circ\text{C}$ (Free Air)	1A
@ $T_L = 50^\circ\text{C}$, $L = \frac{3}{8}"$	2A
Surge Current, 8.3mSec	20A
Thermal Resistance @ $L = \frac{3}{8}"$	38°C/W
Operating and Storage Temperature Range	-55°C to +150°C

MECHANICAL SPECIFICATIONS

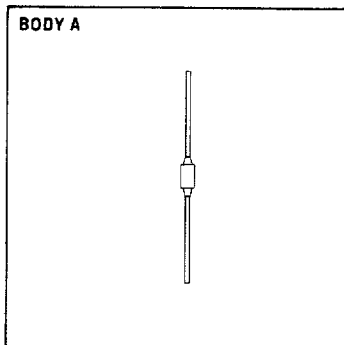
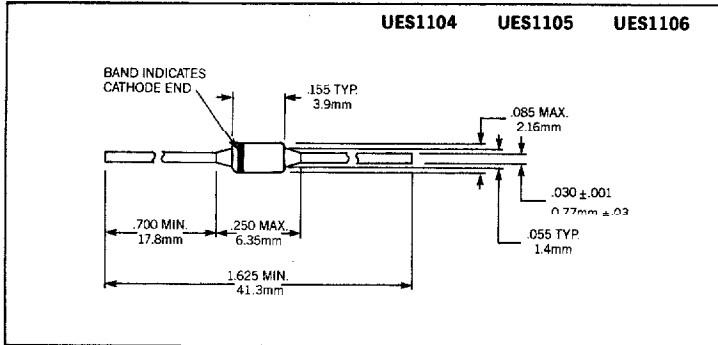

THESE DEVICES ALSO AVAILABLE IN SURFACE MOUNT PACKAGE. SEE SECTION 10

ELECTRICAL SPECIFICATIONS

Type	PIV	Maximum Forward Voltage		Maximum Reverse Current		Maximum Reverse Recovery Time*
		$T_J = 25^\circ\text{C}$	$T_J = 100^\circ\text{C}$	@ PIV, $T_J = 25^\circ\text{C}$	$T_J = 100^\circ\text{C}$	
UES1104/1104HR	200V	1.25V @ 1A tp = 300 μ S	1.15V @ 1A tp = 300 μ S	10 μ A	200 μ A	50nS
UES1105/1105HR	300V					
UES1106/1106HR	400V					

* Measured in circuit $I_F = 0.5A$, $I_R = 1A$, $I_{REC} = 0.25A$

Output Current vs. Lead Temperature

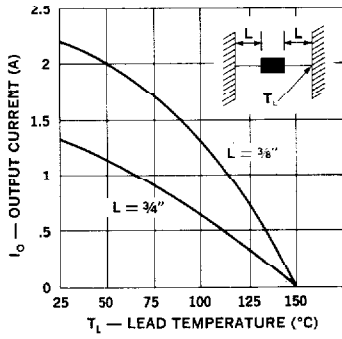

Peak Output Current vs. Lead Temperature

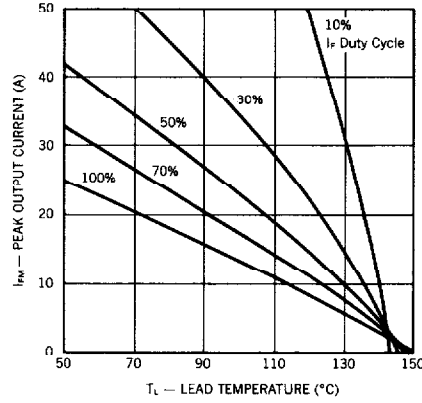

Typical Forward Current vs. Forward Voltage

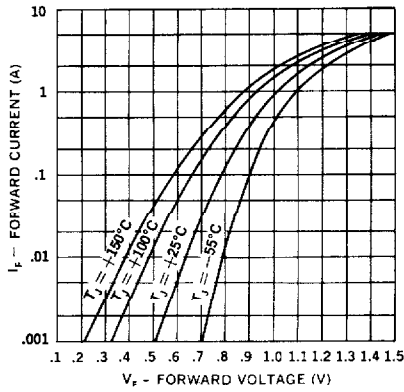

Typical Reverse Current vs. Reverse Voltage

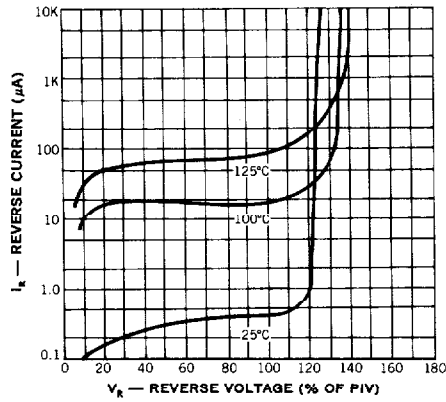

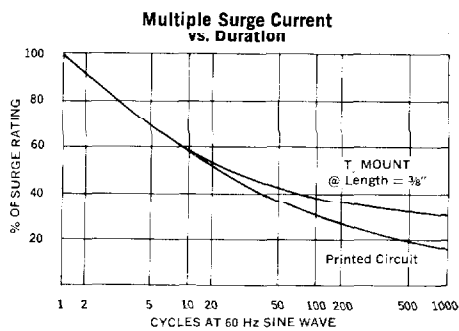
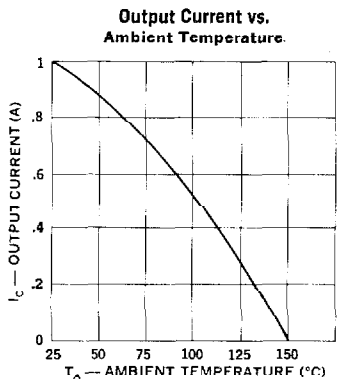

Reverse-Recovery Circuit

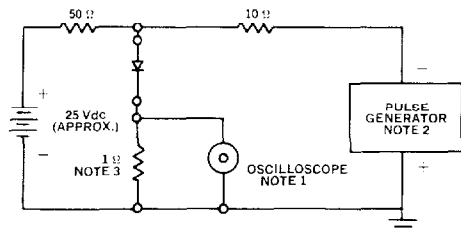

- NOTES:**
1. Oscilloscope: Rise time ≤ 3 ns; input impedance = 50Ω .
 2. Pulse Generator: Rise time ≤ 8 ns; source impedance 10Ω .
 3. Current viewing resistor, non-inductive, coaxial recommended.

• OPTIONAL HIGH RELIABILITY (HR2) SCREENING (See 1N6620-1N6625)