

Switching (60V, 300mA)

RK7002A

●Features

- 1) Low on-resistance.
- 2) High ESD
- 3) High-speed switching.
- 4) Low-voltage drive (4V).
- 5) Easily designed drive circuits.
- 6) Easy to use in parallel.

●Structure

Silicon N-channel
MOSFET transistor

●Equivalent circuit

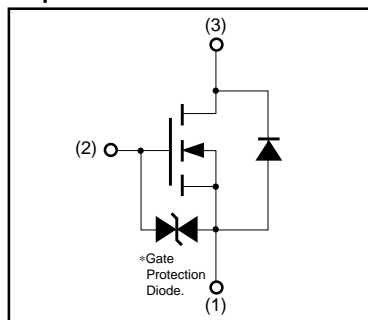

* A protection diode has been built in between the gate and the source to protect against static electricity when the product is in use.
Use the protection circuit when fixed voltages are exceeded.

●External dimensions (Units : mm)

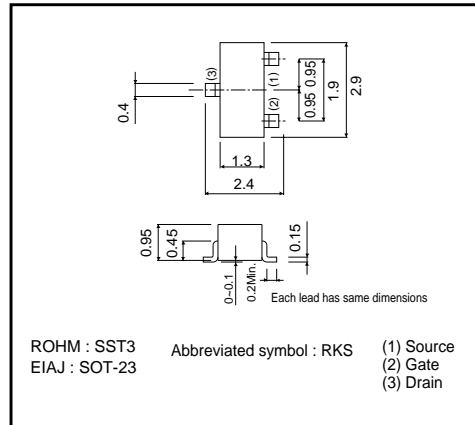

●Absolute maximum ratings (Ta=25°C)

Parameter	Symbol	Limits	Unit
Drain-source voltage	V_{DSS}	60	V
Gate-source voltage	V_{GSS}	± 20	V
Drain current	Continuous	I_D	300 mA
	Pulsed	I_{DP}^{*1}	1.2 A
Drain reverse current	Continuous	I_{DR}	300 mA
	Pulsed	I_{DRP}^{*1}	1.2 A
Total power dissipation	P_D^{*2}	200	mW
Channel temperature	T_{ch}	150	°C
Storage temperature	T_{stg}	-55~+150	°C

*1 $P_w \leq 10 \mu s$, Duty cycle $\leq 1\%$

*2 When using 1x0.75x0.062 inch glass epoxy board.

Transistors

●Electrical characteristics (Ta=25°C)

Parameter	Symbol	Min.	Typ.	Max.	Unit	Test Conditions
Gate leakage current	I _{GSS}	-	-	±10	μA	V _{GS} =±20V, V _{DS} =0V
Drain-source breakdown voltage	V _{(BR)DSS}	60	-	-	V	I _D =10μA, V _{GS} =0V
Drain cutoff current	I _{DSS}	-	-	1	μA	V _{DS} =60V, V _{GS} =0V
Gate threshold voltage	V _{GS(th)}	1	-	2.5	V	V _{DS} =10V, I _D =1mA
Drain-source on-state resistance	R _{DS(on)} *1	-	0.7	1.0	Ω	I _D =300mA, V _{GS} =10V
		-	1.1	1.5		I _D =300mA, V _{GS} =4V
Forward transfer admittance	Y _{fs} *1	200	-	-	mS	V _{DS} =10V, I _D =300mA
Input capacitance	C _{iss}	-	33	-	pF	V _{DS} =10V
Output capacitance	C _{oss}	-	14	-	pF	V _{GS} =0V
Reverse transfer capacitance	C _{rss}	-	9	-	pF	f=1MHz
Turn-on delay time	t _{d(on)} *2	-	6	-	ns	I _D =150mA, V _{DD} =30V
Rise time	t _r *2	-	5	-	ns	V _{GS} =10V
Turn-off delay time	t _{d(off)} *2	-	13	-	ns	R _L =200Ω
Fall time	t _f *2	-	80	-	ns	R _{GS} =10Ω
Total gate charge	Q _g *2	-	3	6	nC	V _{DD} =30V
Gate-source charge	Q _{gs} *2	-	0.6	-	nC	V _{GS} =10V
Gate-drain charge	Q _{gd} *2	-	0.5	-	nC	I _D =200mA

*1 P_W≤300μs, Duty cycle≤1%
 *2 Pulsed

●Packaging specifications

Type	Package	Taping
	Code	T116
	Basic ordering unit (pieces)	3000
RK7002A		○

●Electrical characteristic curves

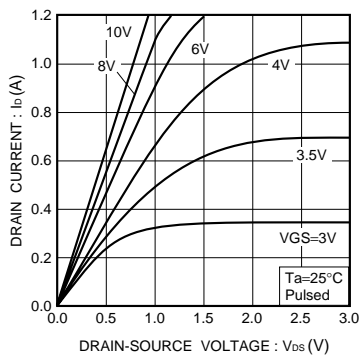

Fig.1 Typical output characteristics

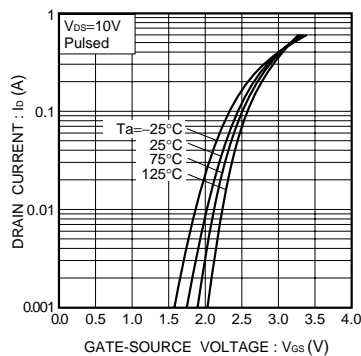

Fig.2 Typical transfer characteristics

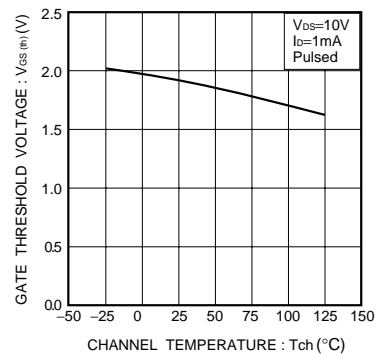

Fig.3 Gate threshold voltage vs. channel temperature

Transistors

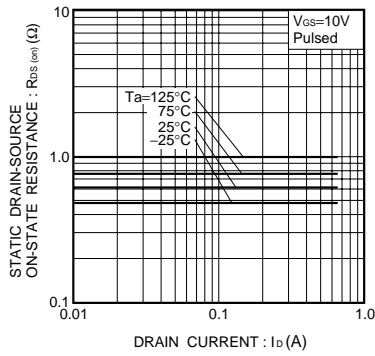

Fig.4 Static drain-source on-state resistance vs. drain current (I)

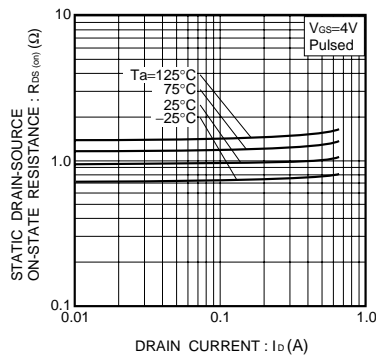

Fig.5 Static drain-source on-state resistance vs. drain current (II)

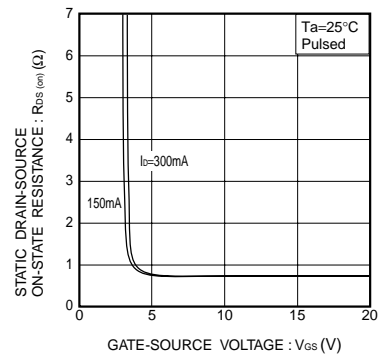

Fig.6 Static drain-source on-state resistance vs. gate-source voltage

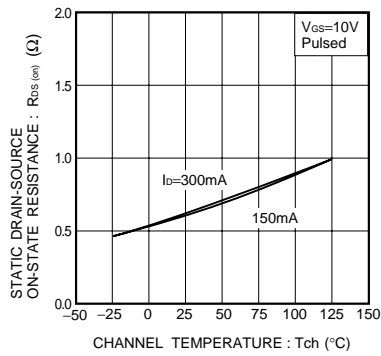

Fig.7 Static drain-source on-state resistance vs. channel temperature

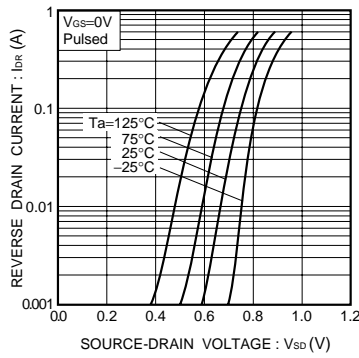

Fig.8 Reverse drain current vs. source-drain voltage (I)

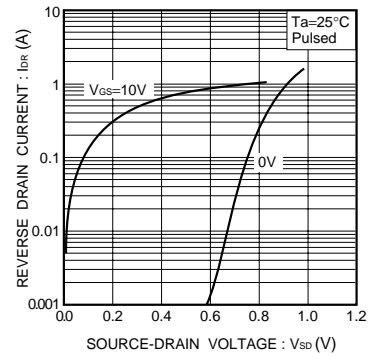

Fig.9 Reverse drain current vs. source-drain voltage (II)

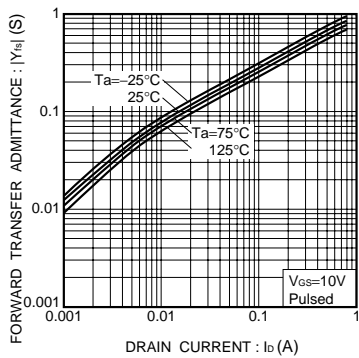

Fig.10 Forward transfer admittance vs. drain current

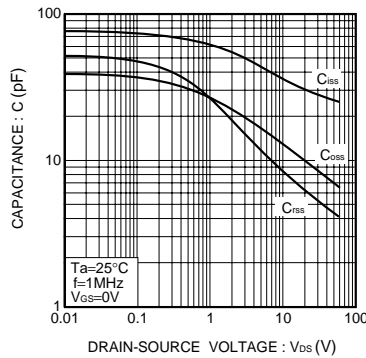

Fig.11 Typical capacitance vs. drain-source voltage

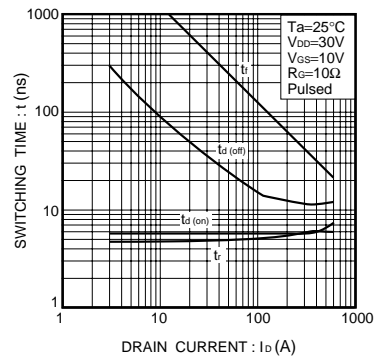

Fig.12 Switching characteristics (See Figures 13 and 14 for the measurement circuit and resultant waveforms)

Transistors

● Switching characteristics measurement circuit

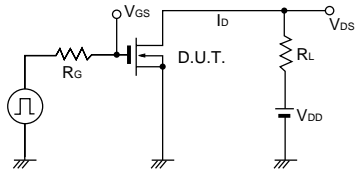

Fig.13 Switching time measurement circuit

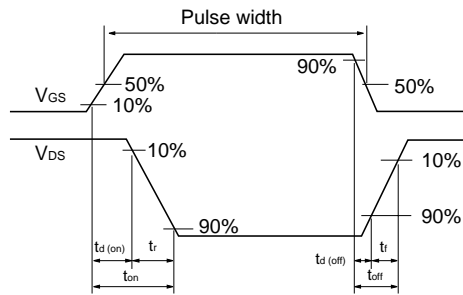

Fig.14 Switching time waveforms