

General purpose transistor (isolated transistor and diode)

UML12N

2SC4617 and RB521S-30 are housed independently in a UMT5 package.

●Applications

DC / DC converter
Motor driver

●Features

- 1) Tr : Low $V_{CE(sat)}$
Di : Low V_f
- 2) Small package

●Structure

Silicon epitaxial planar transistor
Schottky barrier diode

●Equivalent circuit

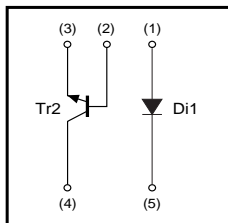

●External dimensions (Units : mm)

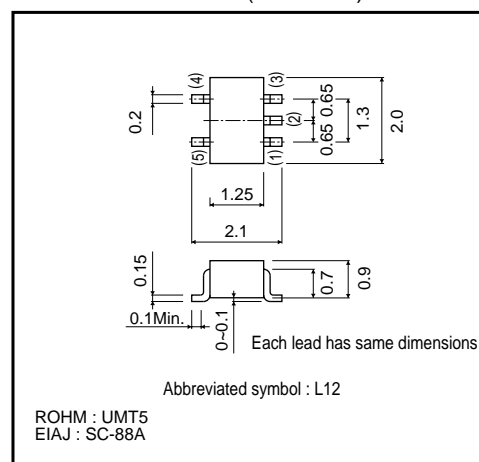

●Packaging specifications

Type	UML12N
Package	UMT5
Marking	L12
Code	TR
Basic ordering unit (pieces)	3000

Transistors

●Absolute maximum ratings (Ta=25°C)

Di1

Parameter	Symbol	Limits	Unit
Average rectified forward current	I _O	200	mA
Forward current surge peak (60Hz, 1∞)	I _{FSM}	1	A
Reverse voltage (DC)	V _R	30	V
Junction temperature	T _j	125	°C
Range of storage temperature	T _{stg}	-55~+125	°C

Tr2

Parameter	Symbol	Limits	Unit
Collector-base voltage	V _{CB0}	60	V
Collector-emitter voltage	V _{CEO}	50	V
Emitter-base voltage	V _{EBO}	7	V
Collector current	I _C	150	mA
Power dissipation	P _D	120	mW *
Junction temperature	T _j	150	°C
Storage temperature	T _{stg}	-55~+125	°C

* Each terminal mount on a recommended.

●Electrical characteristics (Ta=25°C)

Di1

Parameter	Symbol	Min.	Typ.	Max.	Unit	Conditions
Forward voltage	V _R	-	0.40	0.50	V	I _F =200mA
Reverse current	I _R	-	4.0	30	μA	V _R =10V

Tr2

Parameter	Symbol	Min.	Typ.	Max.	Unit	Conditions
Collector-base breakdown voltage	BV _{CB0}	60	-	-	V	I _C =50μA
Collector-emitter breakdown voltage	BV _{CEO}	50	-	-	V	I _C =1mA
Emitter-base breakdown voltage	BV _{EBO}	7	-	-	V	I _E =50μA
Collector cutoff current	I _{CB0}	-	-	0.1	μA	V _{CB} =60V
Emitter cutoff current	I _{EBO}	-	-	0.1	μA	V _{EB} =7V
Collector-emitter saturation voltage	V _{CE(sat)}	-	-	0.4	V	I _C /I _B =50mA/5mA
DC current transfer ratio	h _{FE}	180	-	390	-	V _{CE} =6V, I _C =1mA
Transition frequency	f _T	-	180	-	MHz	V _{CE} =12V, I _E =-2mA, f=100MHz
Output capacitance	C _{ob}	-	2	3.5	PF	V _{CB} =12V, I _E =0A, f=1MHz

Transistors

●Electrical characteristic curves

Di1

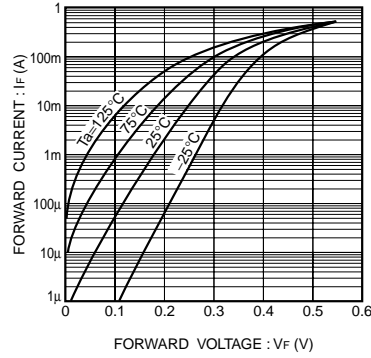

Fig.1 Forward characteristics

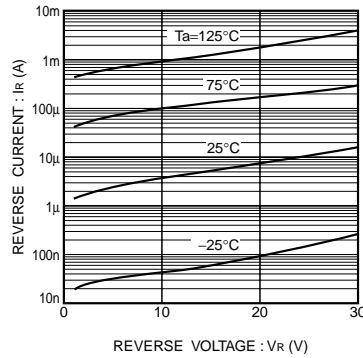

Fig.2 Reverse characteristics

Tr2

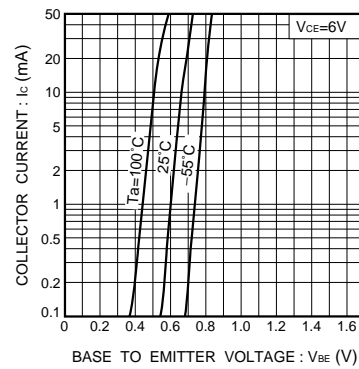

Fig.1 Grounded emitter propagation characteristics

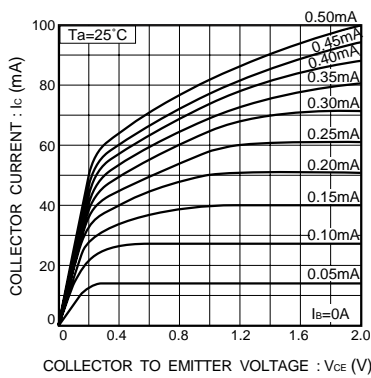

Fig.2 Grounded emitter output characteristics (I)

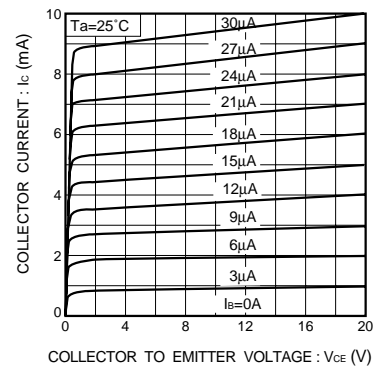

Fig.3 Grounded emitter output characteristics (II)

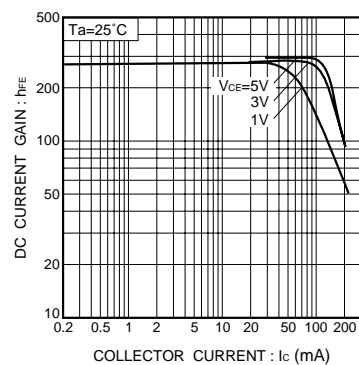

Fig.4 DC current gain vs. collector current (I)

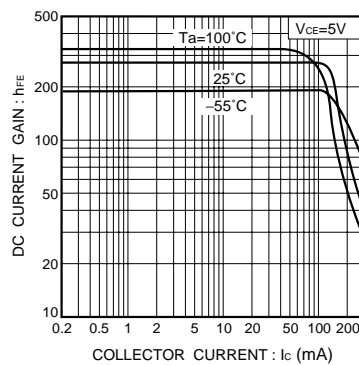

Fig.5 DC current gain vs. collector current (II)

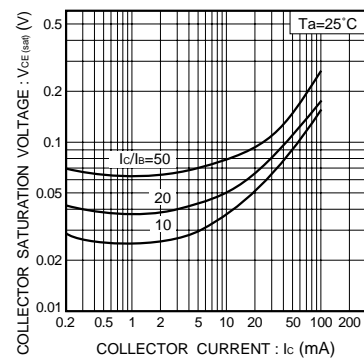

Fig.6 Collector-emitter saturation voltage vs. collector current

Transistors

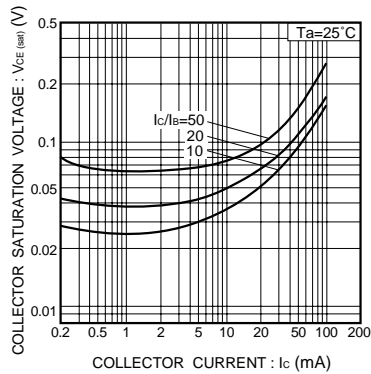

Fig.7 Collector-emitter saturation voltage vs. collector current (I)

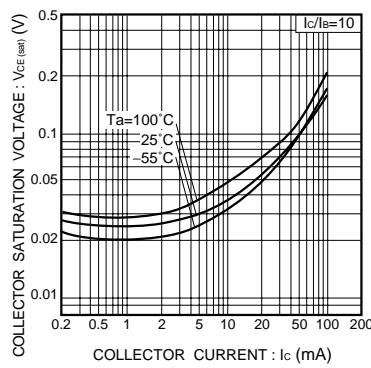

Fig.8 Collector-emitter saturation voltage vs. collector current (II)

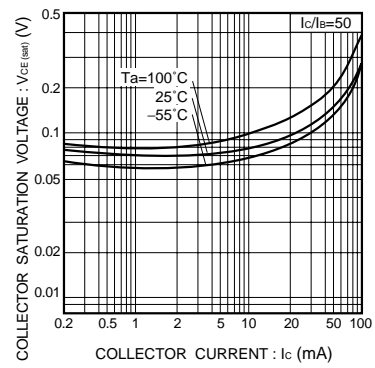

Fig.9 Collector-emitter saturation voltage vs. collector current (III)

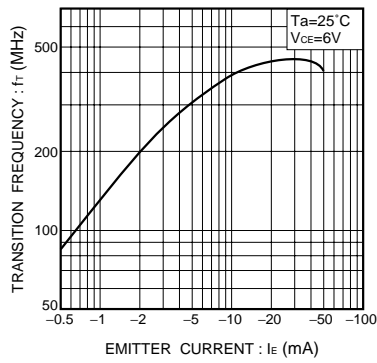

Fig.10 Gain bandwidth product vs. emitter current

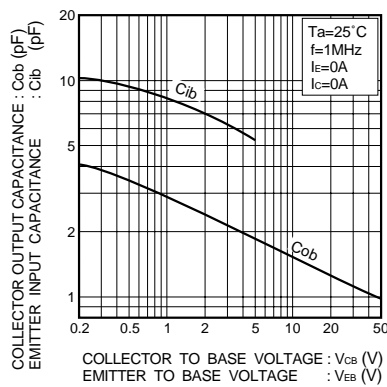

Fig.11 Collector output capacitance vs. collector-base voltage
Emitter input capacitance vs. emitter-base voltage

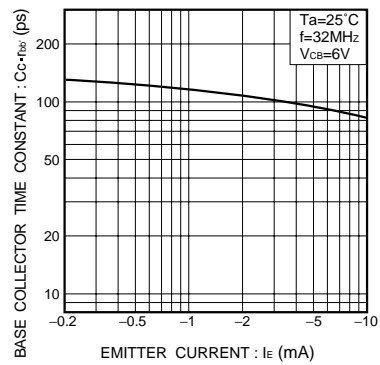

Fig.12 Base-collector time constant vs. emitter current