

2SC4053

(T5V45FX)

5A NPN

OUTLINE DIMENSIONS

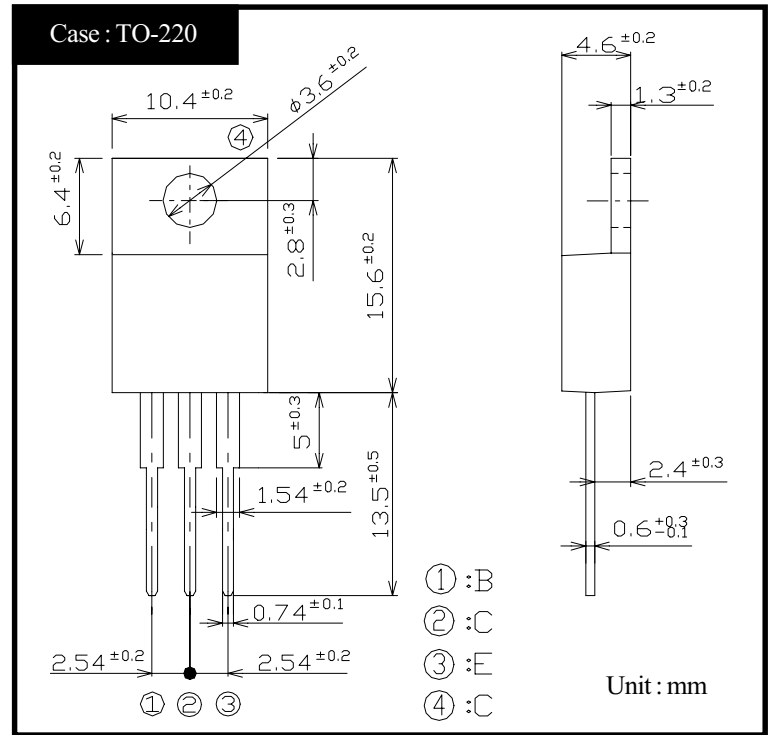

RATINGS

● Absolute Maximum Ratings

Item	Symbol	Conditions	Ratings	Unit
Storage Temperature	T_{stg}		-55 ~ 150	°C
Junction Temperature	T_j		150	°C
Collector to Base Voltage	V_{CBO}		600	V
Collector to Emitter Voltage	V_{CEO}		450	V
	V_{CEX}	$V_{EB} = 5V$	600	
Emitter to Base Voltage	V_{EBO}		7	V
Collector Current DC	I_C		5	A
Collector Current Peak	I_{CP}		10	
Base Current DC	I_B		2	A
Base Current Peak	I_{BP}		4	
Total Transistor Dissipation	P_T	$T_c = 25^\circ C$	50	W
Mounting Torque	TOR		0.5	N·m

● Electrical Characteristics ($T_c=25^\circ C$)

Item	Symbol	Conditions	Ratings	Unit
Collector to Emitter Sustaining Voltage	$V_{CEO(sus)}$	$I_C = 0.1A$	Min 450	V
Collector Cutoff Current	I_{CBO}	At rated Voltage	Max 0.1	mA
	I_{CEO}		Max 0.1	
Emitter Cutoff Current	I_{EBO}	At rated Voltage	Max 0.1	mA
DC Current Gain	h_{FE}	$V_{CE} = 5V, I_C = 2.5A$	Min 10	
	h_{FEL}	$V_{CE} = 5V, I_C = 1mA$	Min 5	
Collector to Emitter Saturation Voltage	$V_{CE(sat)}$	$I_C = 2.5A$	Max 1.0	V
Base to Emitter Saturation Voltage	$V_{BE(sat)}$	$I_B = 0.5A$	Max 1.5	V
Thermal Resistance	θ_{jc}	Junction to case	Max 2.5	°C/W
Transition Frequency	f_T	$V_{CE} = 10V, I_C = 0.5A$	STD 20	MHz
Turn on Time	t_{on}	$I_C = 2.5A$	Max 0.5	μs
Storage Time	t_s	$I_{B1} = 0.5A, I_{B2} = 1A$	Max 2.0	
Fall Time	t_f	$R_L = 60 \Omega, V_{BB2} = 4V$	Max 0.2	

2SC4053

$h_{FE} - I_C$

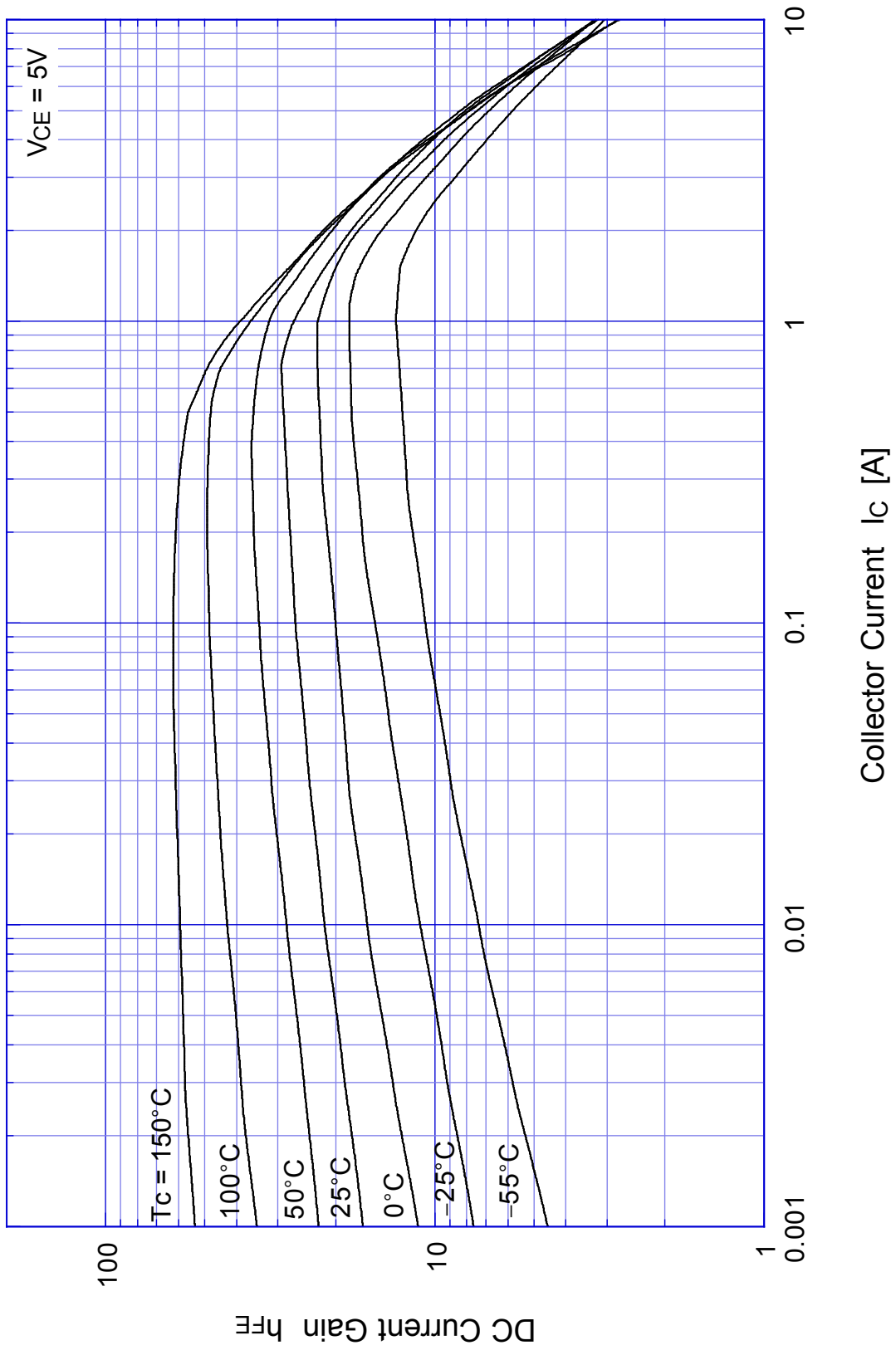

2SC4053 Saturation Voltage

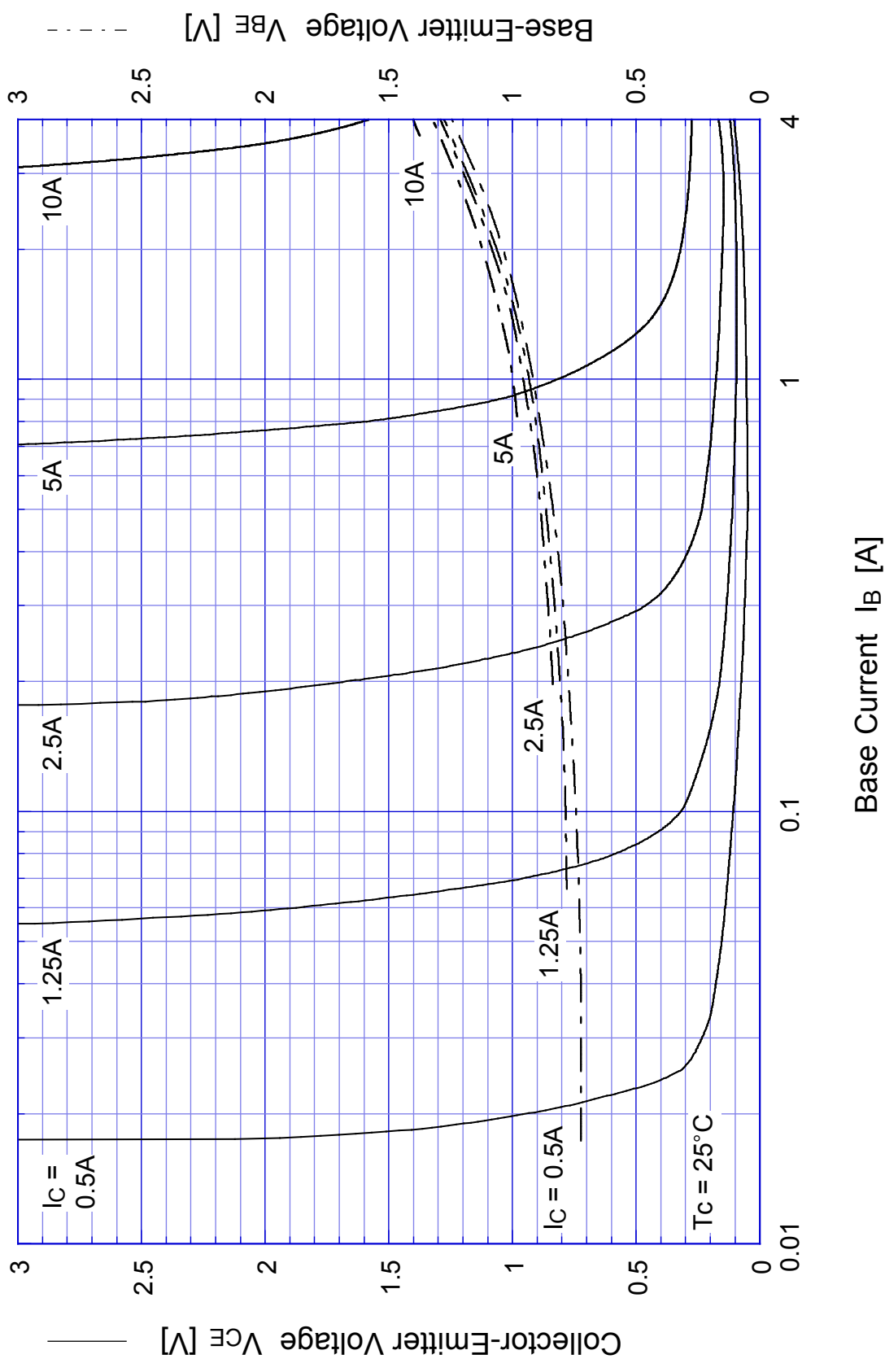

2SC4053

Switching Time - I_C

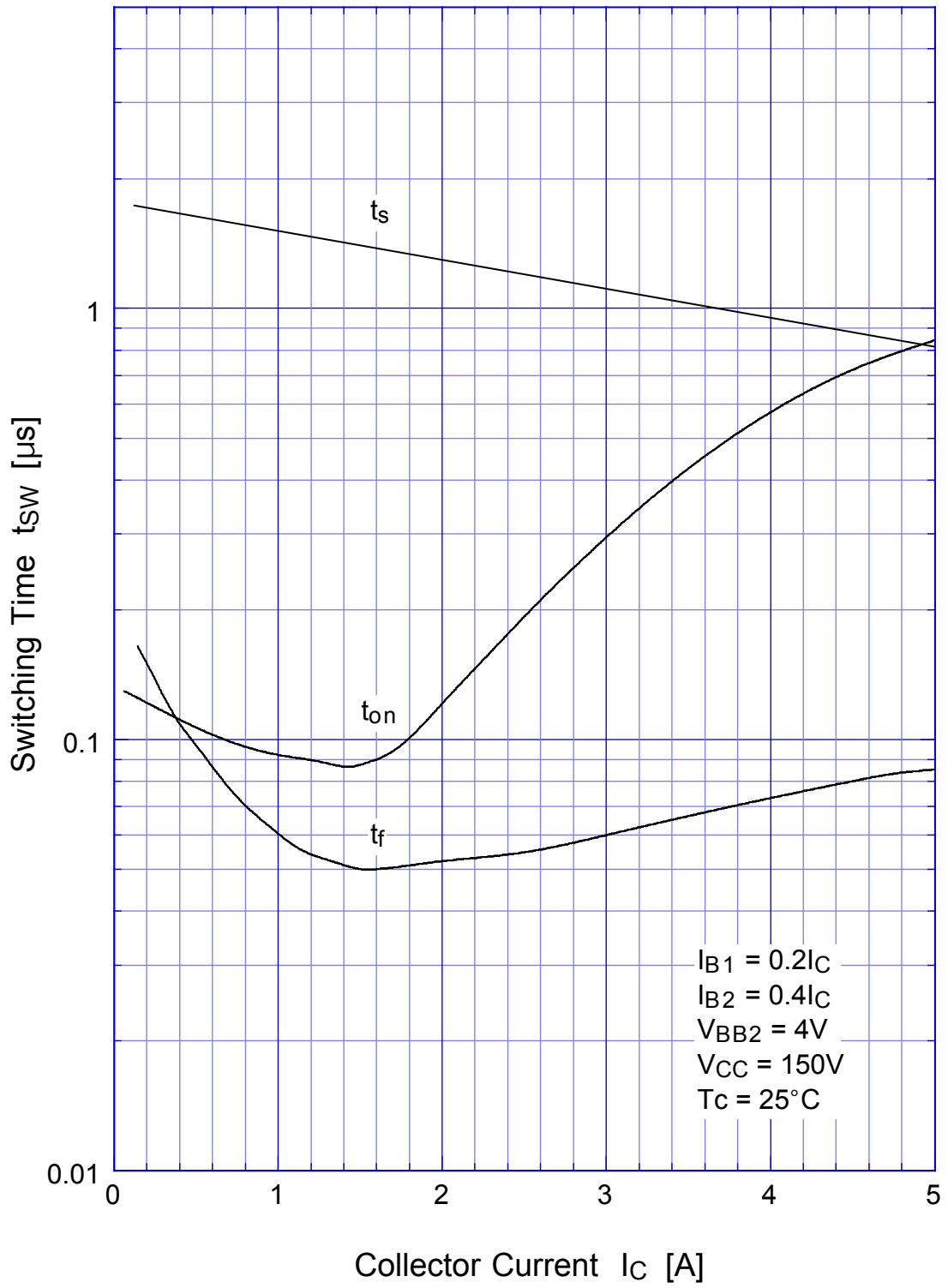

2SC4053 Switching Time - V_{CC}

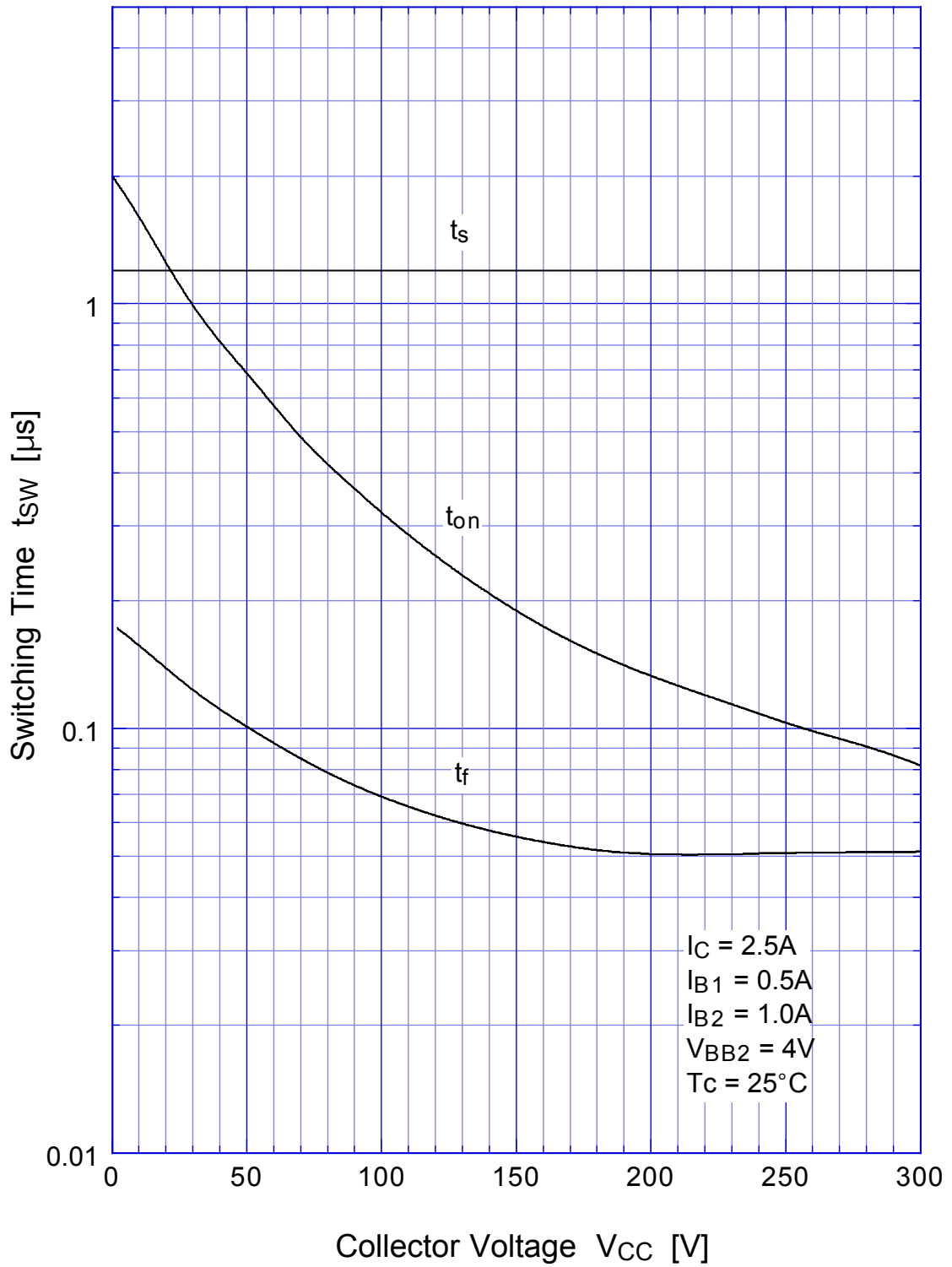

2SC4053

Switching Time - Tc

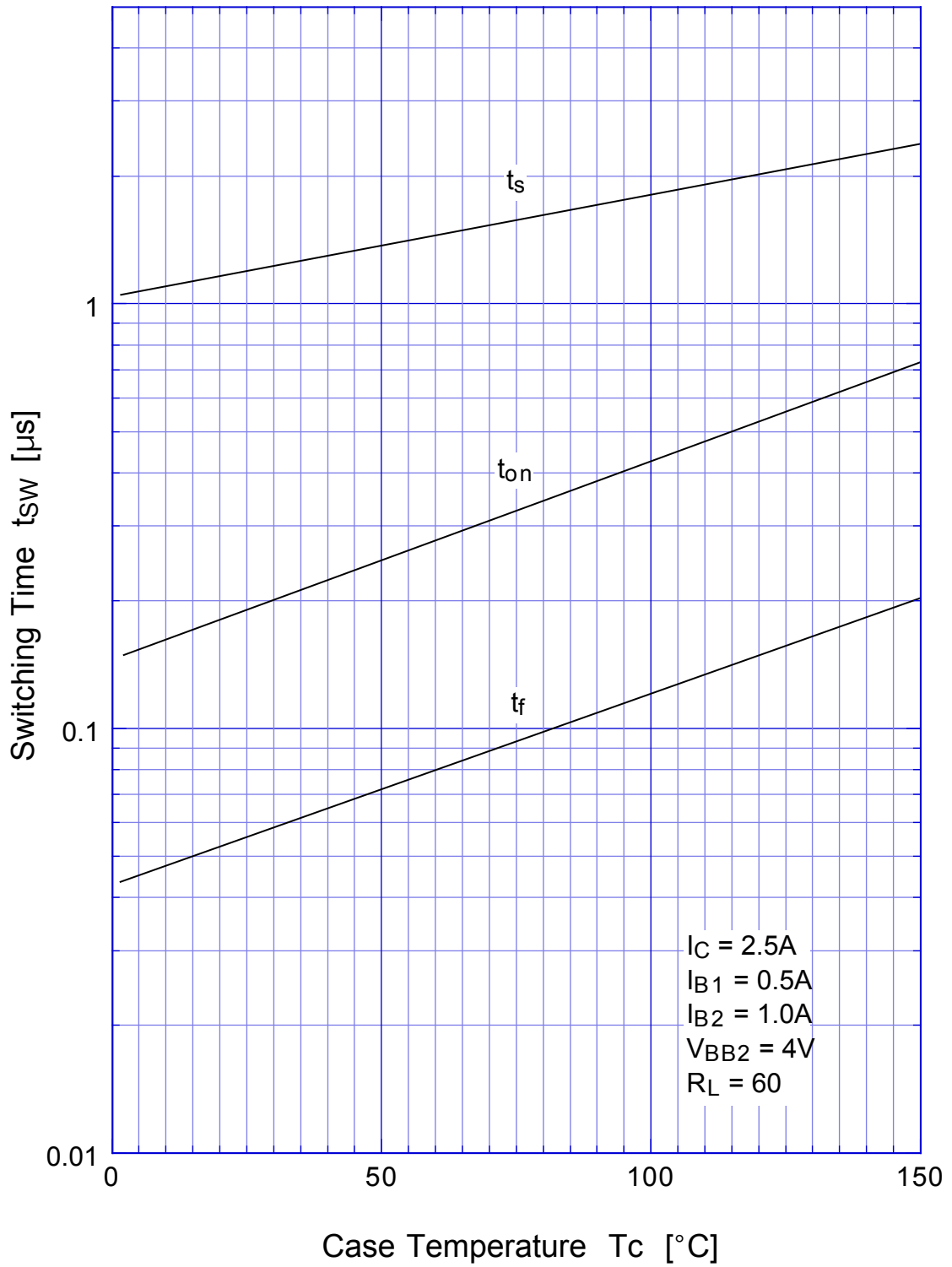

2SC4053 L-Load Switching Time - I_C

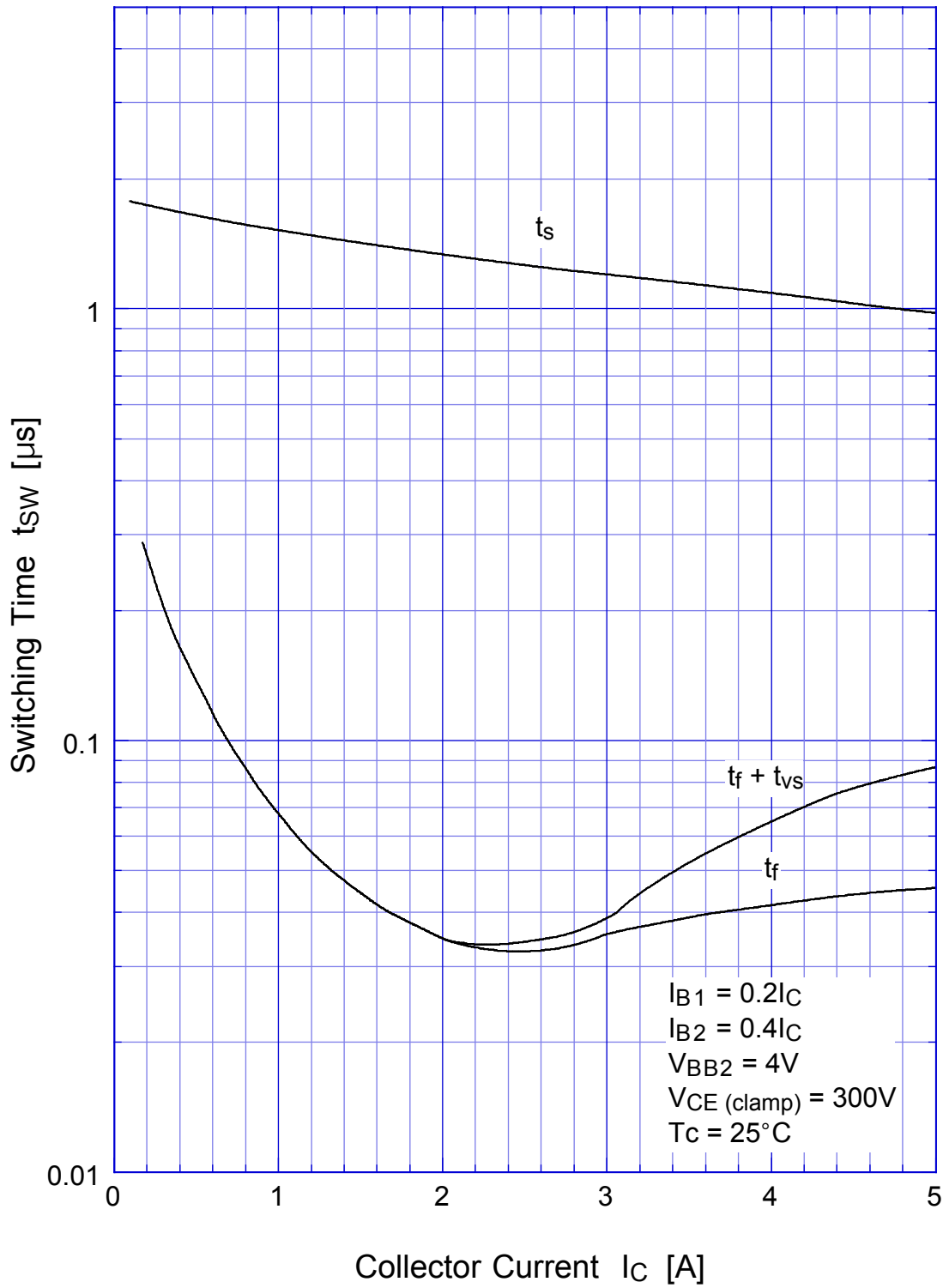

2SC4053 L-Load Switching Time - I_C (At High Temperature)

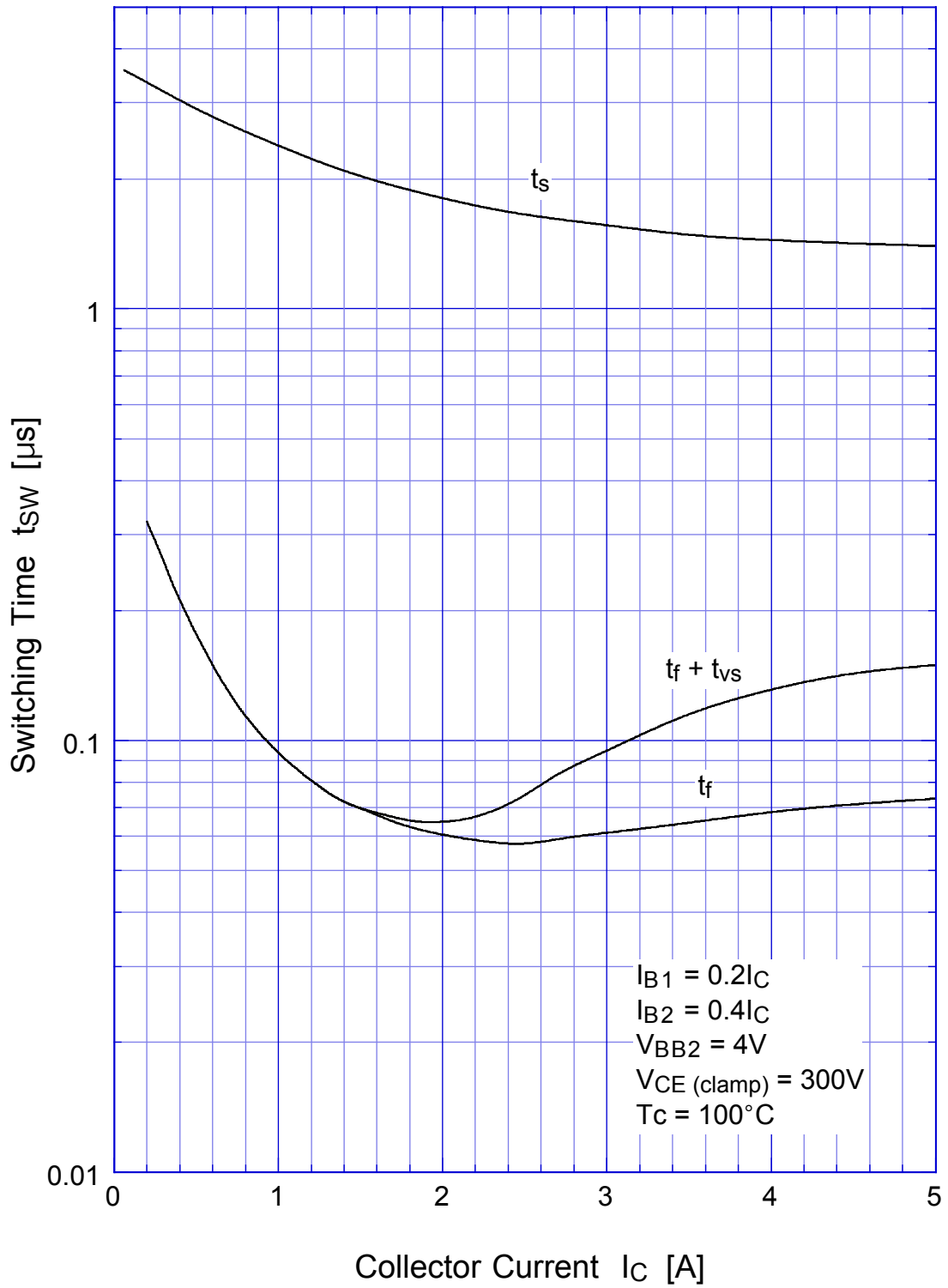

2SC4053 Transient Thermal Impedance

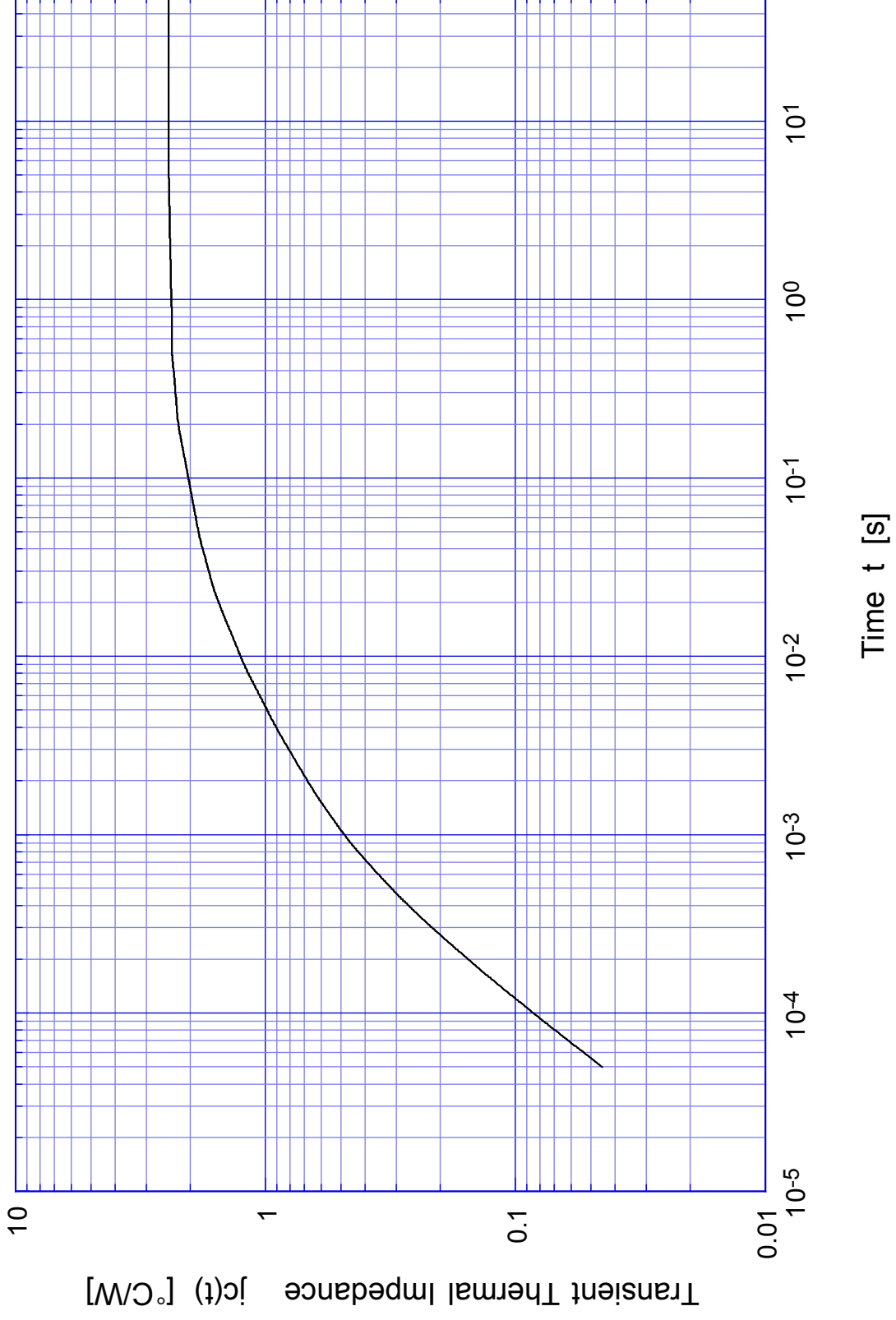

2SC4053

Forward Bias SOA

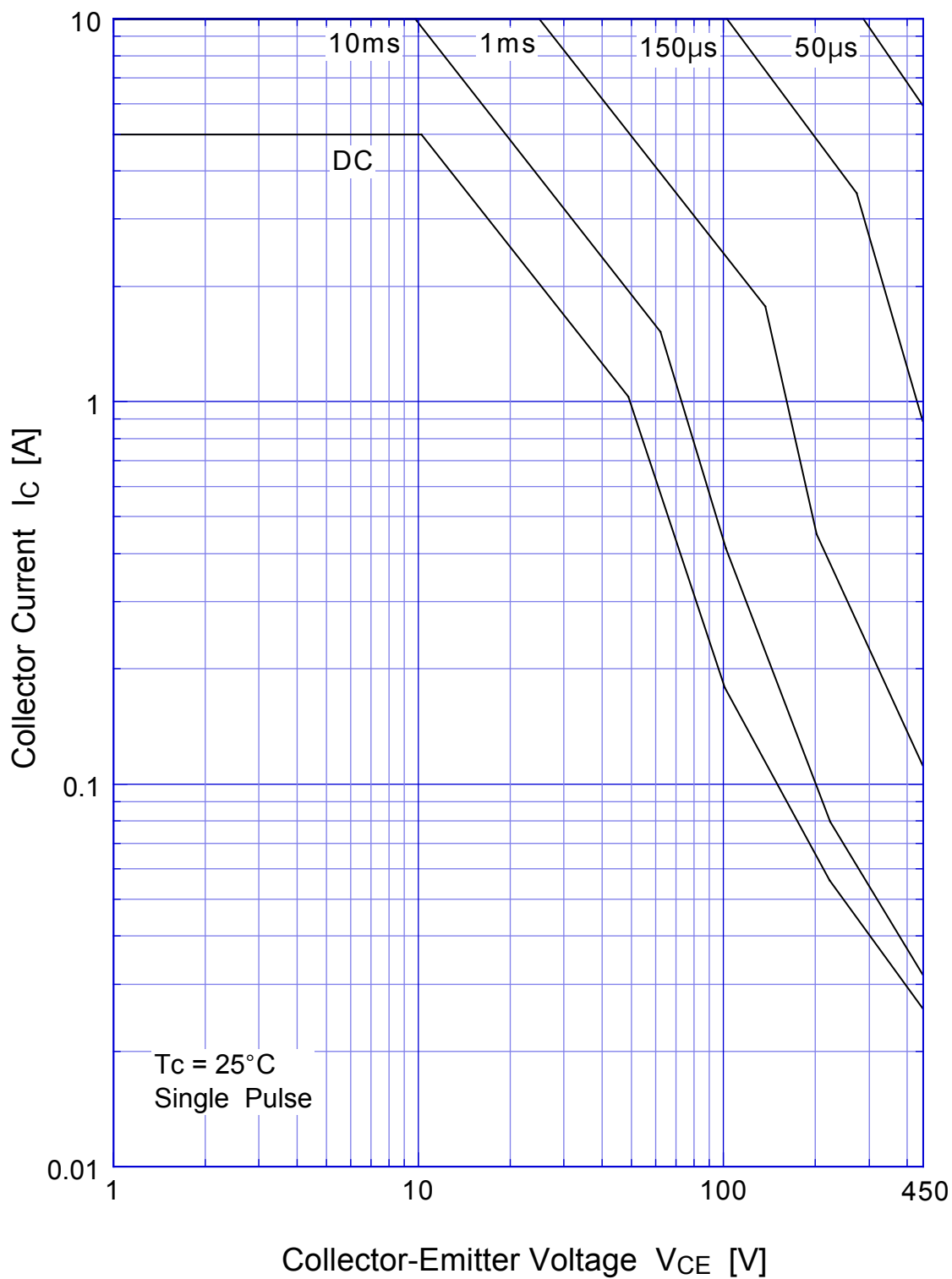

2SC4053 Collector Current Derating

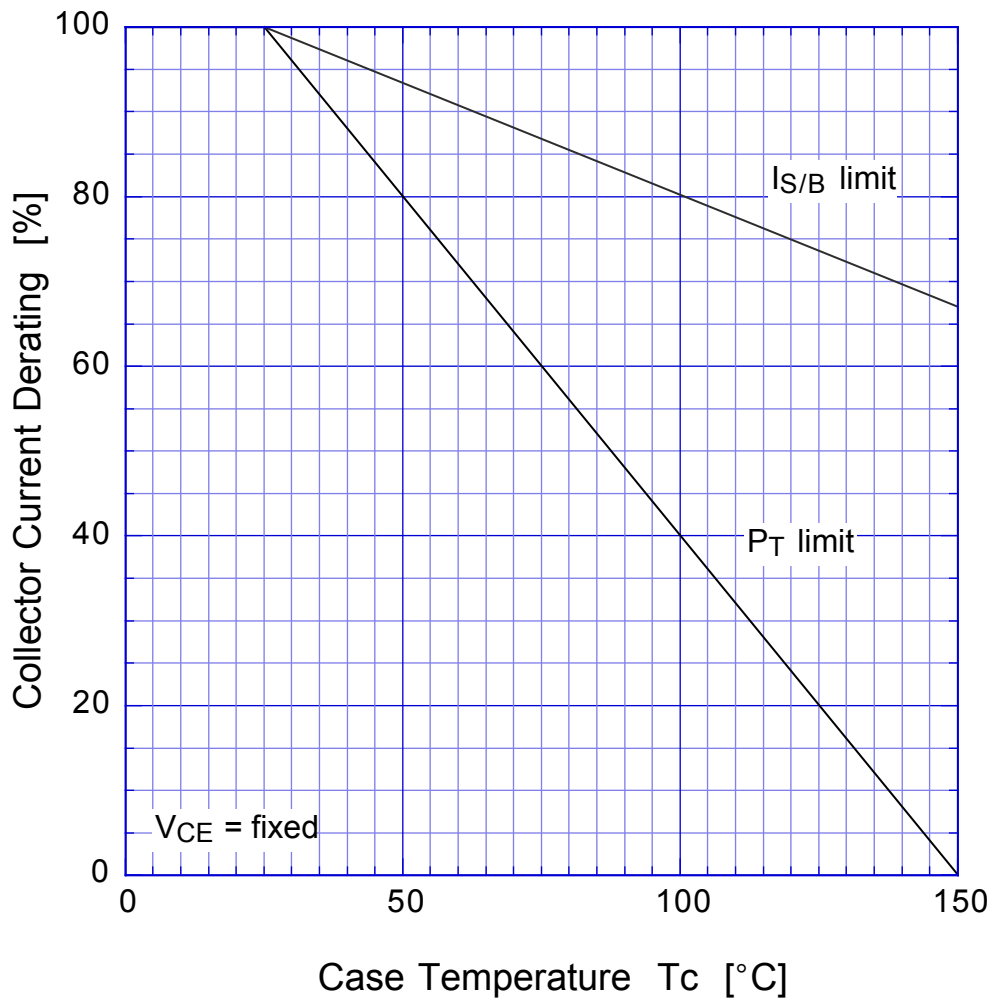

2SC4053

Reverse Bias SOA

