

# 2SC4585

## (TP10W80HFX)

### 10A NPN

### OUTLINE DIMENSIONS

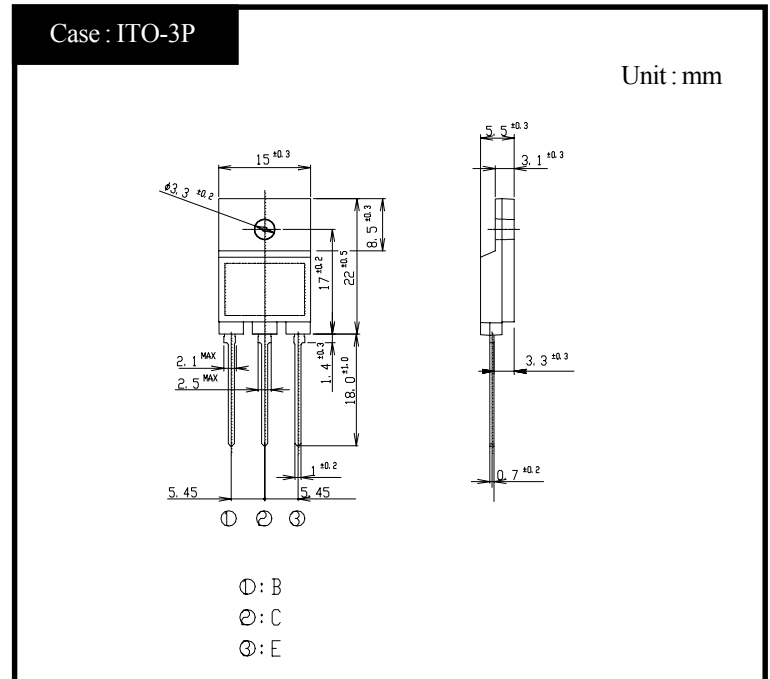

### RATINGS

#### ● Absolute Maximum Ratings

Item	Symbol	Conditions	Ratings	Unit
Storage Temperature	T <sub>stg</sub>		-55~150	°C
Junction Temperature	T <sub>j</sub>		150	°C
Collector to Base Voltage	V <sub>CBO</sub>		1200	V
Collector to Emitter Voltage	V <sub>CEO</sub>		800	V
Emitter to Base Voltage	V <sub>EBO</sub>		7	V
Collector Current DC	I <sub>C</sub>		10	A
Collector Current Peak	I <sub>CP</sub>		20	
Base Current DC	I <sub>B</sub>		4	A
Base Current Peak	I <sub>BP</sub>		8	
Total Transistor Dissipation	P <sub>T</sub>	T <sub>c</sub> = 25°C	85	W
Dielectric Strength	V <sub>dis</sub>	Terminals to case, AC 1 minute	2	kV
Mounting Torque	TOR	(Recommended torque : 0.5N·m)	0.8	N·m

#### ● Electrical Characteristics (T<sub>c</sub>=25°C)

Item	Symbol	Conditions	Ratings	Unit
Collector to Emitter Sustaining Voltage	V <sub>CEO(sus)</sub>	I <sub>C</sub> = 0.2A	Min 800	V
Collector Cutoff Current	I <sub>CBO</sub>	At rated Voltage	Max 0.1	mA
	I <sub>CEO</sub>		Max 0.1	
Emitter Cutoff Current	I <sub>EBO</sub>	At rated Voltage	Max 0.1	mA
DC Current Gain	h <sub>FE</sub>	V <sub>CE</sub> = 5V, I <sub>C</sub> = 5A	Min 8	
	h <sub>FEL</sub>	V <sub>CE</sub> = 5V, I <sub>C</sub> = 1mA	Min 7	
Collector to Emitter Saturation Voltage	V <sub>CE(sat)</sub>	I <sub>C</sub> = 5A	Max 1.0	V
Base to Emitter Saturation Voltage	V <sub>BE(sat)</sub>	I <sub>B</sub> = 1A	Max 1.5	V
Thermal Resistance	θ <sub>jc</sub>	Junction to case	Max 1.47	°C/W
Transition Frequency	f <sub>T</sub>	V <sub>CE</sub> = 10V, I <sub>C</sub> = 1A	TYP 8	MHz
Turn on Time	t <sub>on</sub>	I <sub>C</sub> = 5A	Max 0.5	μs
Storage Time	t <sub>s</sub>	I <sub>B1</sub> = 1A, I <sub>B2</sub> = 2A	Max 3.5	
Fall Time	t <sub>f</sub>	R <sub>L</sub> = 50Ω, V <sub>BB2</sub> = 4V	Max 0.3	

# 2SC4585

$h_{FE} - I_C$

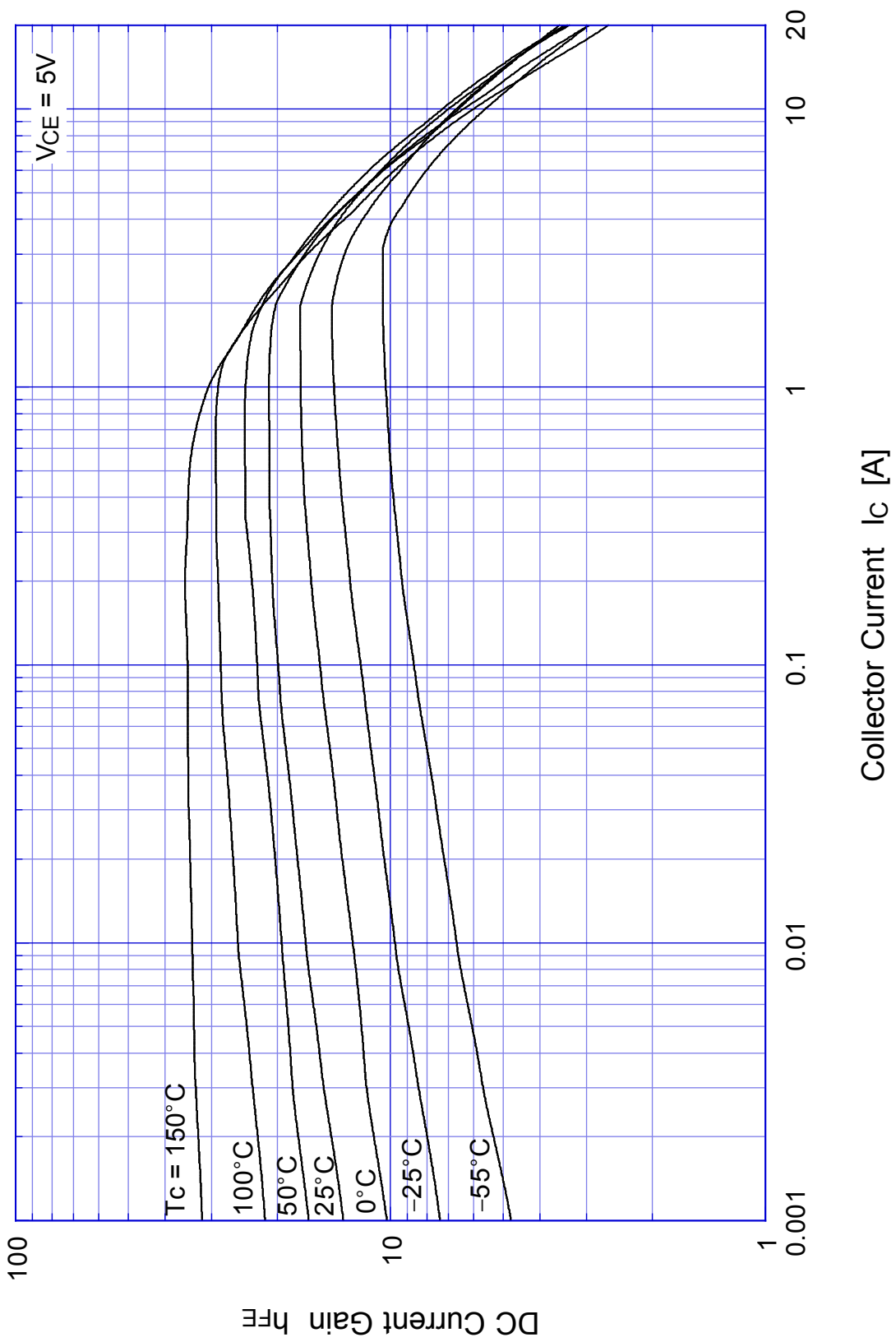

# 2SC4585 Saturation Voltage

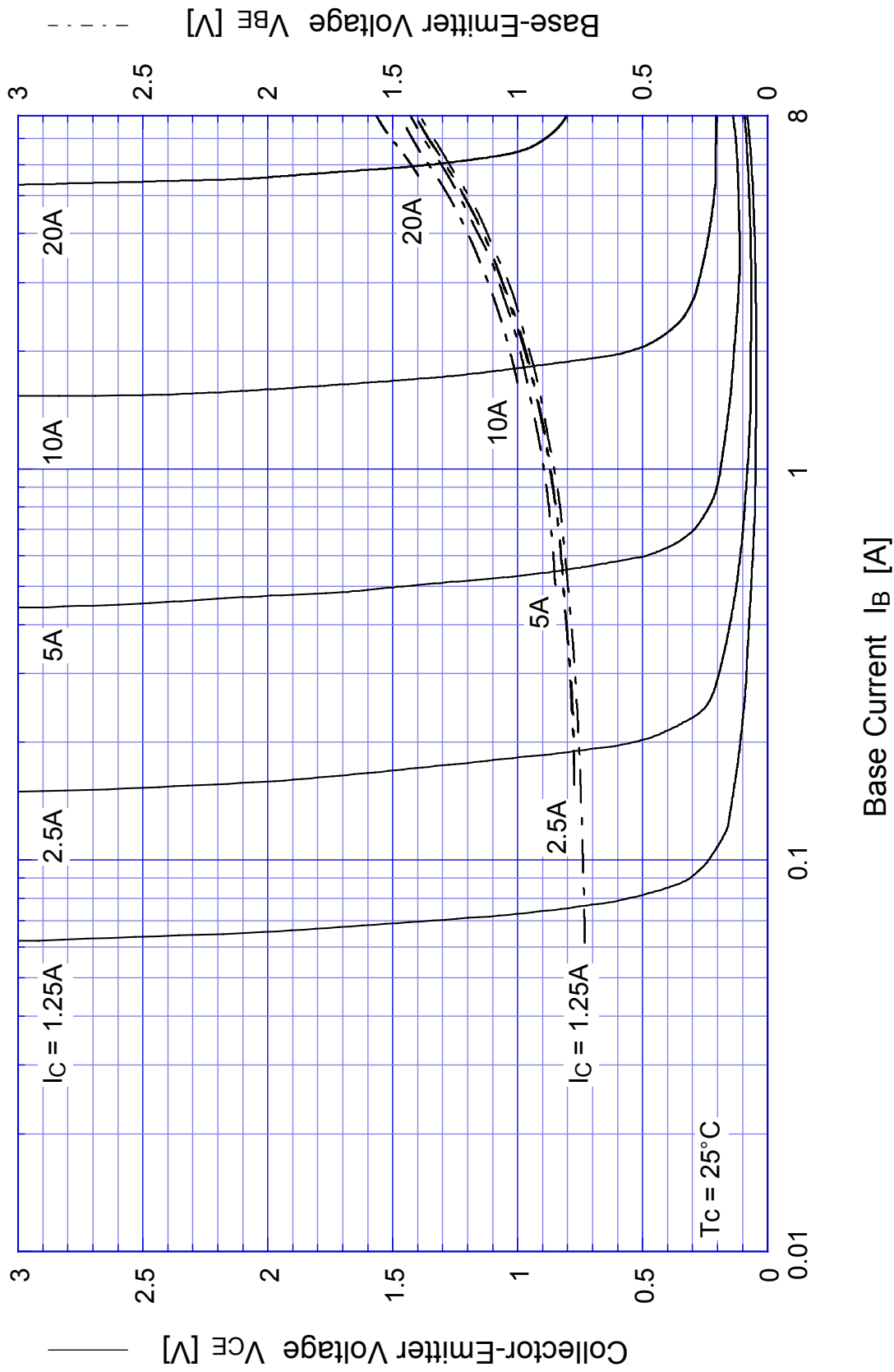

# 2SC4585

## Switching Time - $I_C$

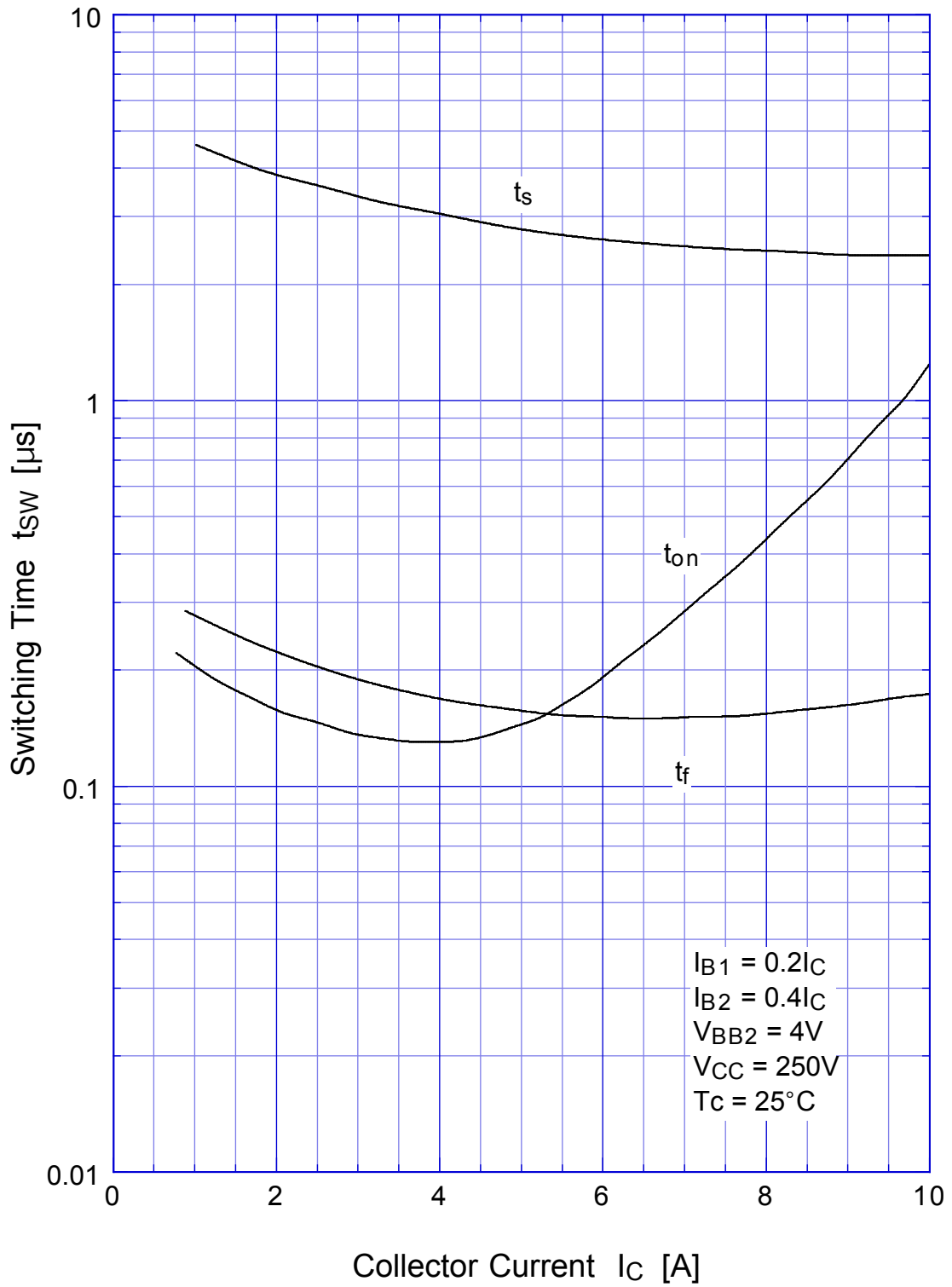

# 2SC4585 Switching Time - $V_{CC}$

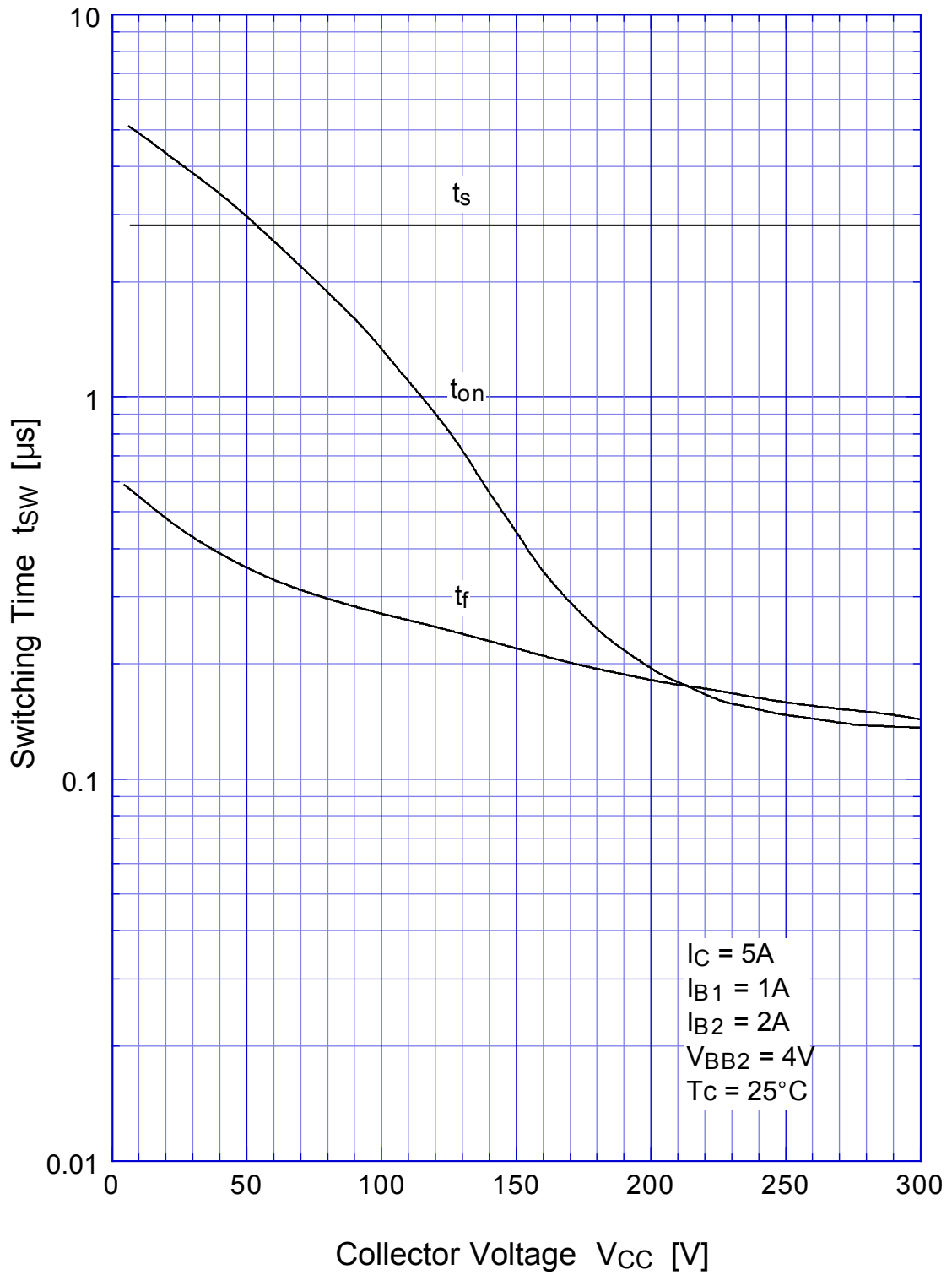

# 2SC4585

## Switching Time - Tc

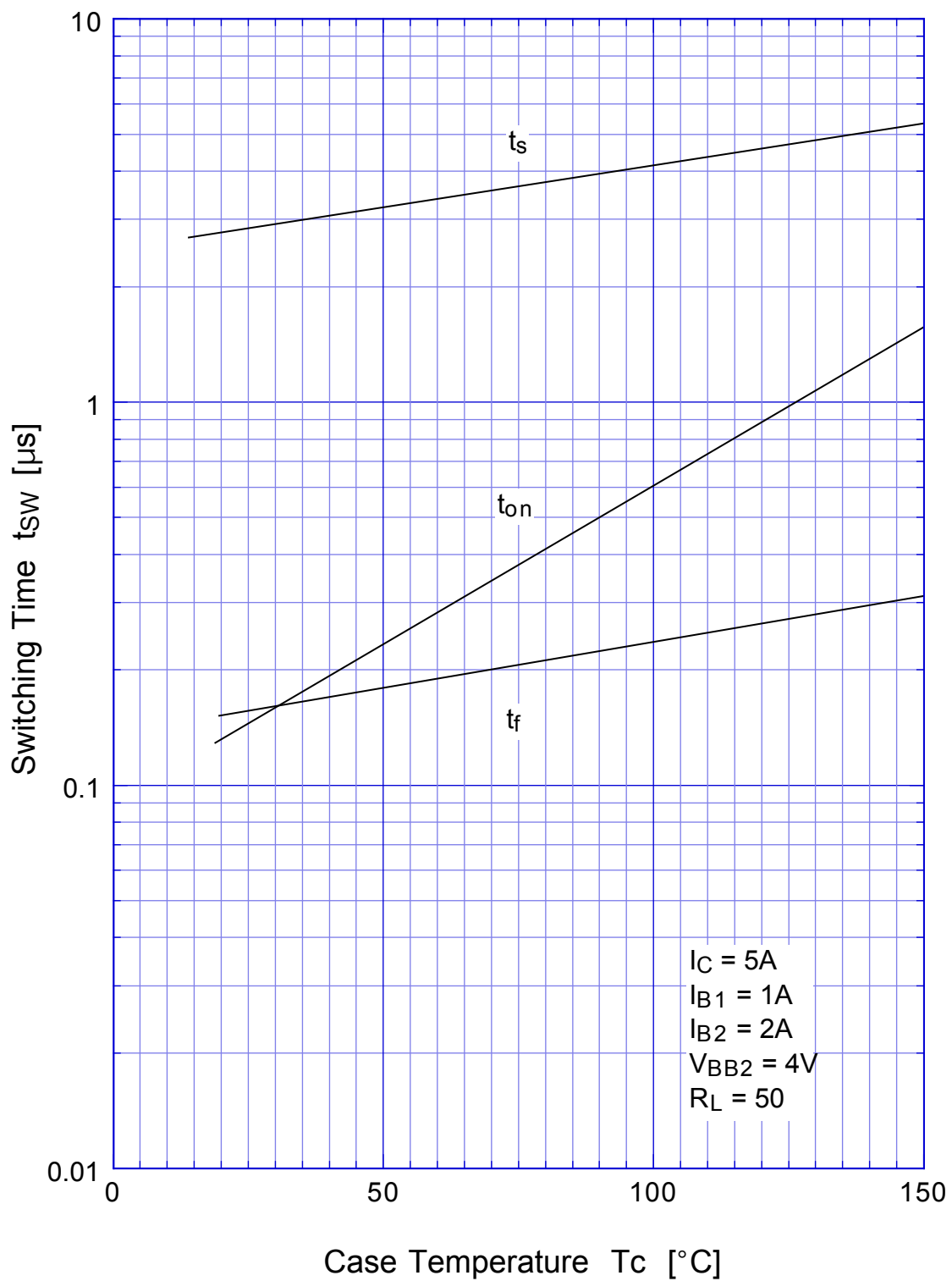

## 2SC4585 Transient Thermal Impedance

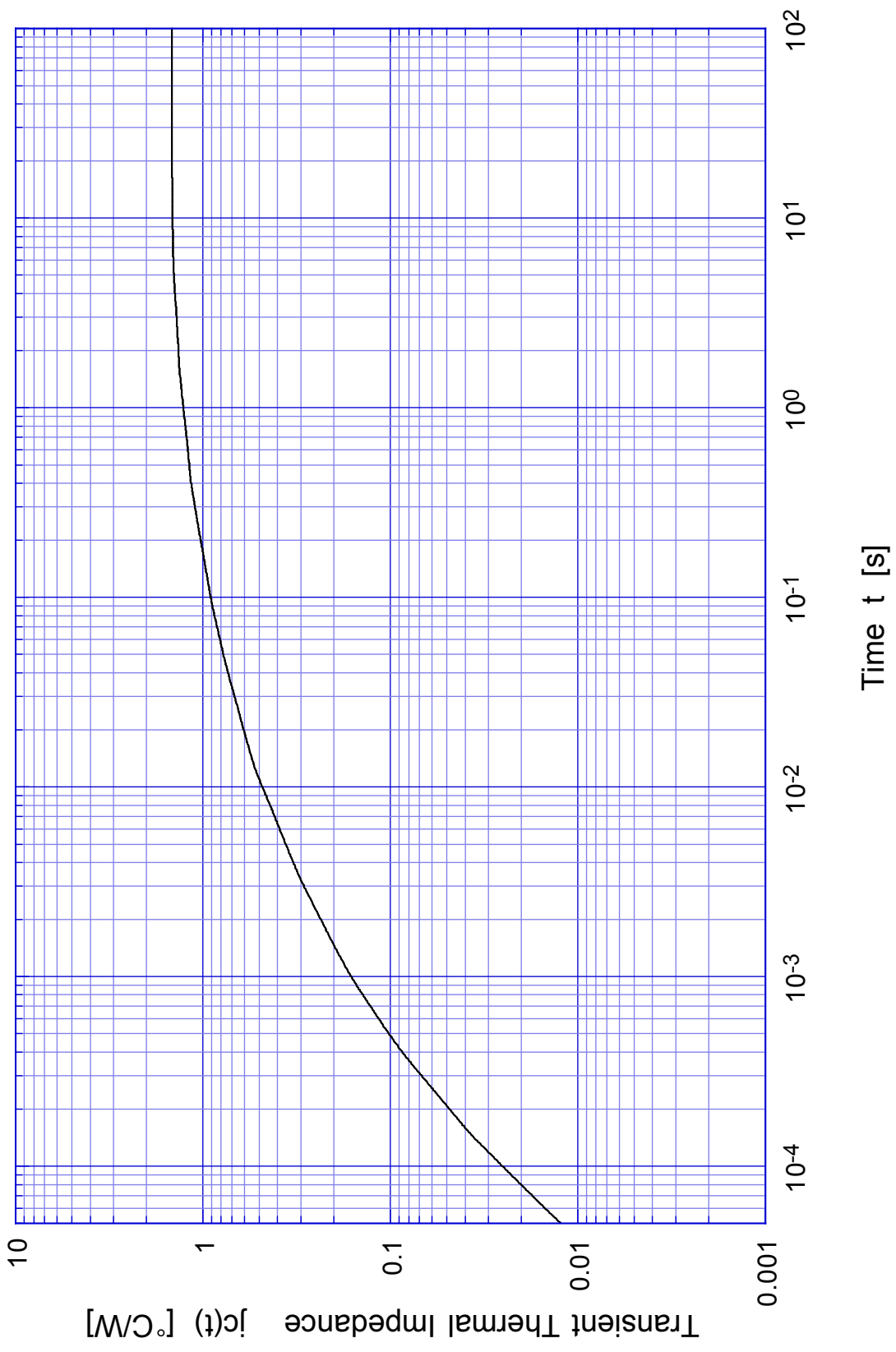

# 2SC4585

## Forward Bias SOA

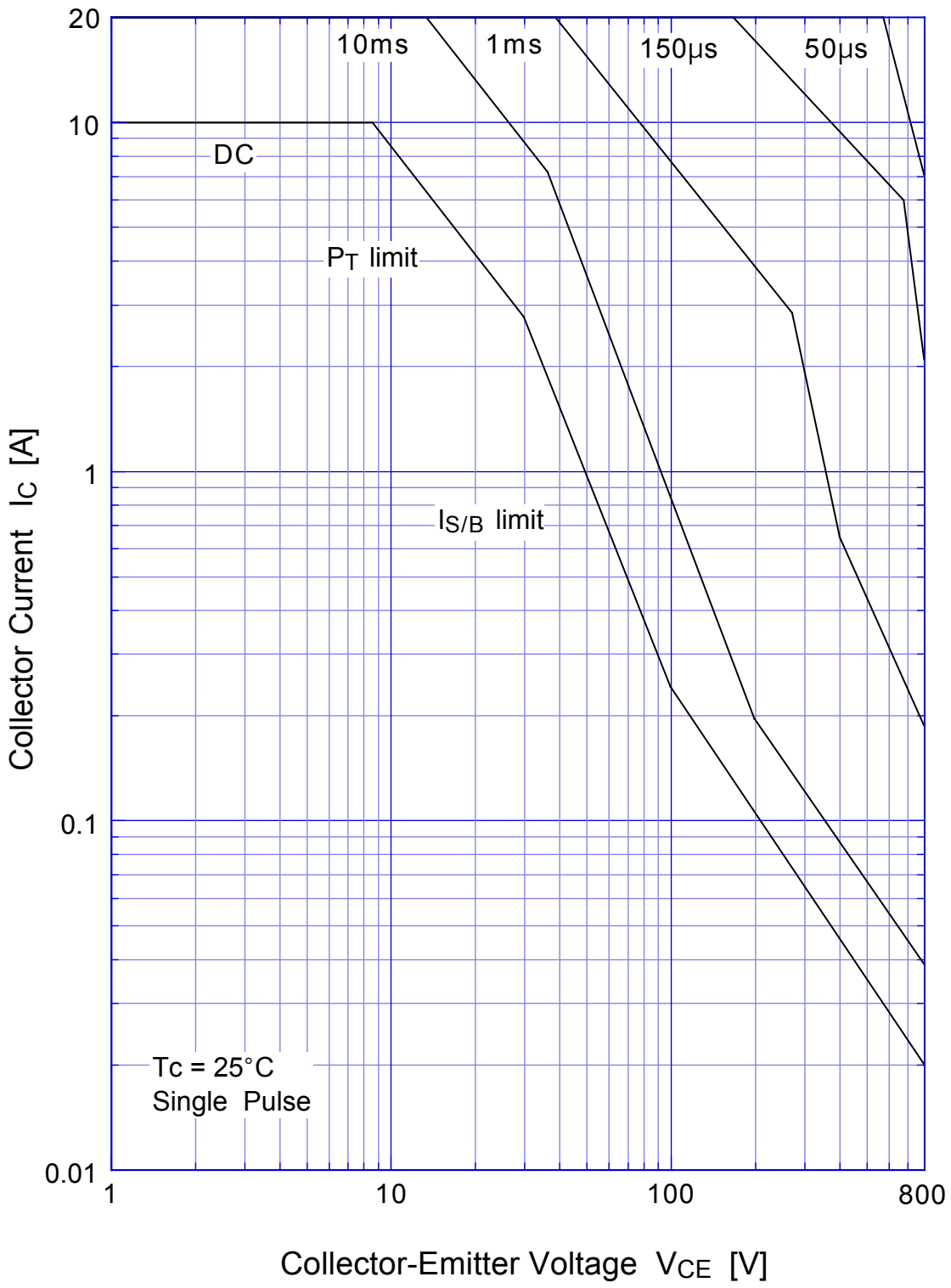



## 2SC4585 Collector Current Derating

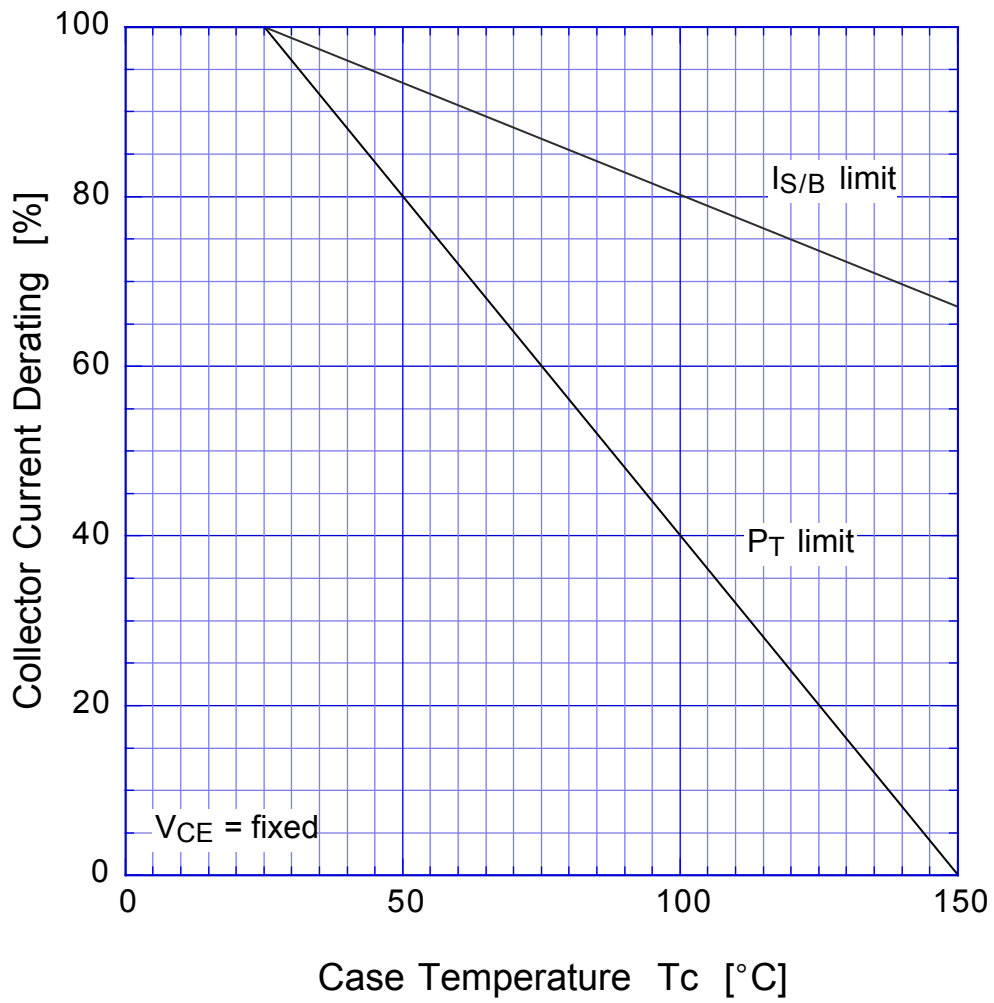

2SC4585

Reverse Bias SOA

