

2SC4585

(TP10W80HFX)

10A NPN

OUTLINE DIMENSIONS

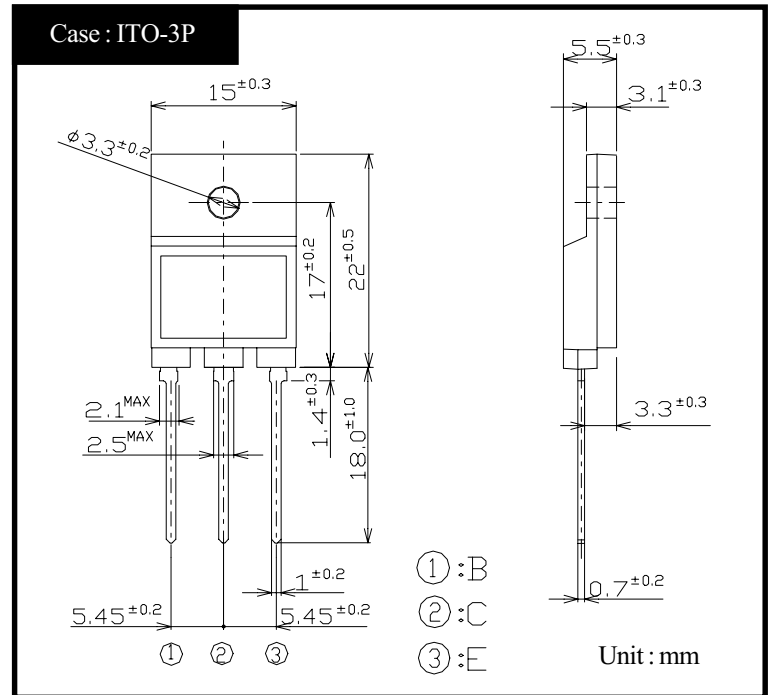

RATINGS

● Absolute Maximum Ratings

| Item | Symbol | Conditions | Ratings | Unit |
|------------------------------|-----------|--------------------------------|---------|------|
| Storage Temperature | T_{stg} | | -55~150 | °C |
| Junction Temperature | T_j | | 150 | °C |
| Collector to Base Voltage | V_{CBO} | | 1200 | V |
| Collector to Emitter Voltage | V_{CEO} | | 800 | V |
| Emitter to Base Voltage | V_{EBO} | | 7 | V |
| Collector Current DC | I_C | | 10 | A |
| Collector Current Peak | I_{CP} | | 20 | |
| Base Current DC | I_B | | 4 | A |
| Base Current Peak | I_{BP} | | 8 | |
| Total Transistor Dissipation | P_T | $T_c = 25^\circ\text{C}$ | 85 | W |
| Dielectric Strength | V_{dis} | Terminals to case, AC 1 minute | 2 | kV |
| Mounting Torque | TOR | (Recommended torque : 0.5N·m) | 0.8 | N·m |

● Electrical Characteristics ($T_c=25^\circ\text{C}$)

| Item | Symbol | Conditions | Ratings | Unit |
|---|----------------|--|----------|---------------|
| Collector to Emitter Sustaining Voltage | $V_{CEO(sus)}$ | $I_C = 0.2\text{A}$ | Min 800 | V |
| Collector Cutoff Current | I_{CBO} | At rated Voltage | Max 0.1 | mA |
| | I_{CEO} | | Max 0.1 | |
| Emitter Cutoff Current | I_{EBO} | At rated Voltage | Max 0.1 | mA |
| DC Current Gain | h_{FE} | $V_{CE} = 5\text{V}, I_C = 5\text{A}$ | Min 8 | |
| | h_{FEL} | $V_{CE} = 5\text{V}, I_C = 1\text{mA}$ | Min 7 | |
| Collector to Emitter Saturation Voltage | $V_{CE(sat)}$ | $I_C = 5\text{A}$ | Max 1.0 | V |
| Base to Emitter Saturation Voltage | $V_{BE(sat)}$ | $I_B = 1\text{A}$ | Max 1.5 | V |
| Thermal Resistance | θ_{jc} | Junction to case | Max 1.47 | °C/W |
| Transition Frequency | f_T | $V_{CE} = 10\text{V}, I_C = 1\text{A}$ | TYP 8 | MHz |
| Turn on Time | t_{on} | $I_C = 5\text{A}$ | Max 0.5 | μs |
| Storage Time | t_s | $I_{B1} = 1\text{A}, I_{B2} = 2\text{A}$ | Max 3.5 | |
| Fall Time | t_f | $R_L = 50\Omega, V_{BB2} = 4\text{V}$ | Max 0.3 | |

2SC4585

$h_{FE} - I_C$

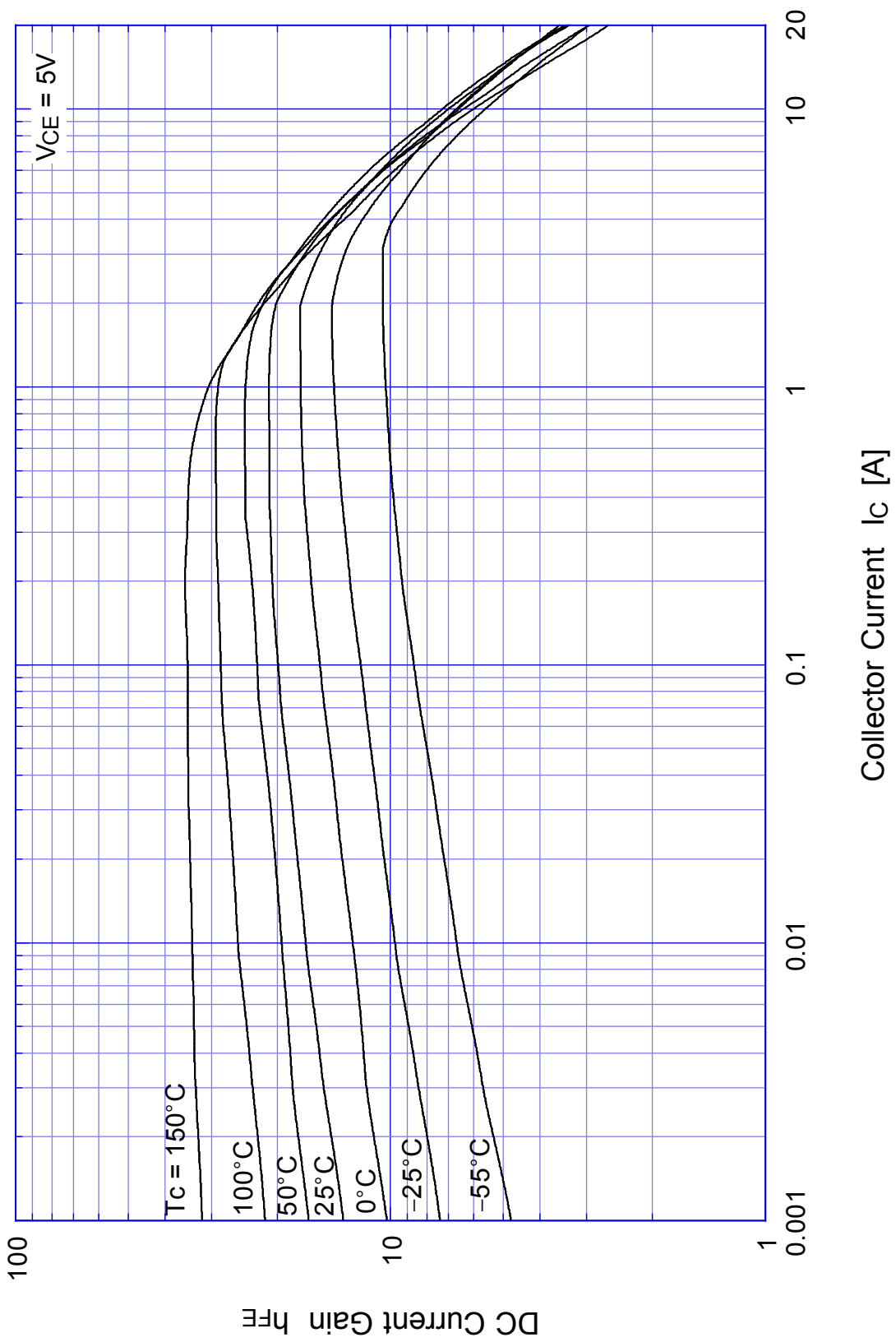

2SC4585 Saturation Voltage

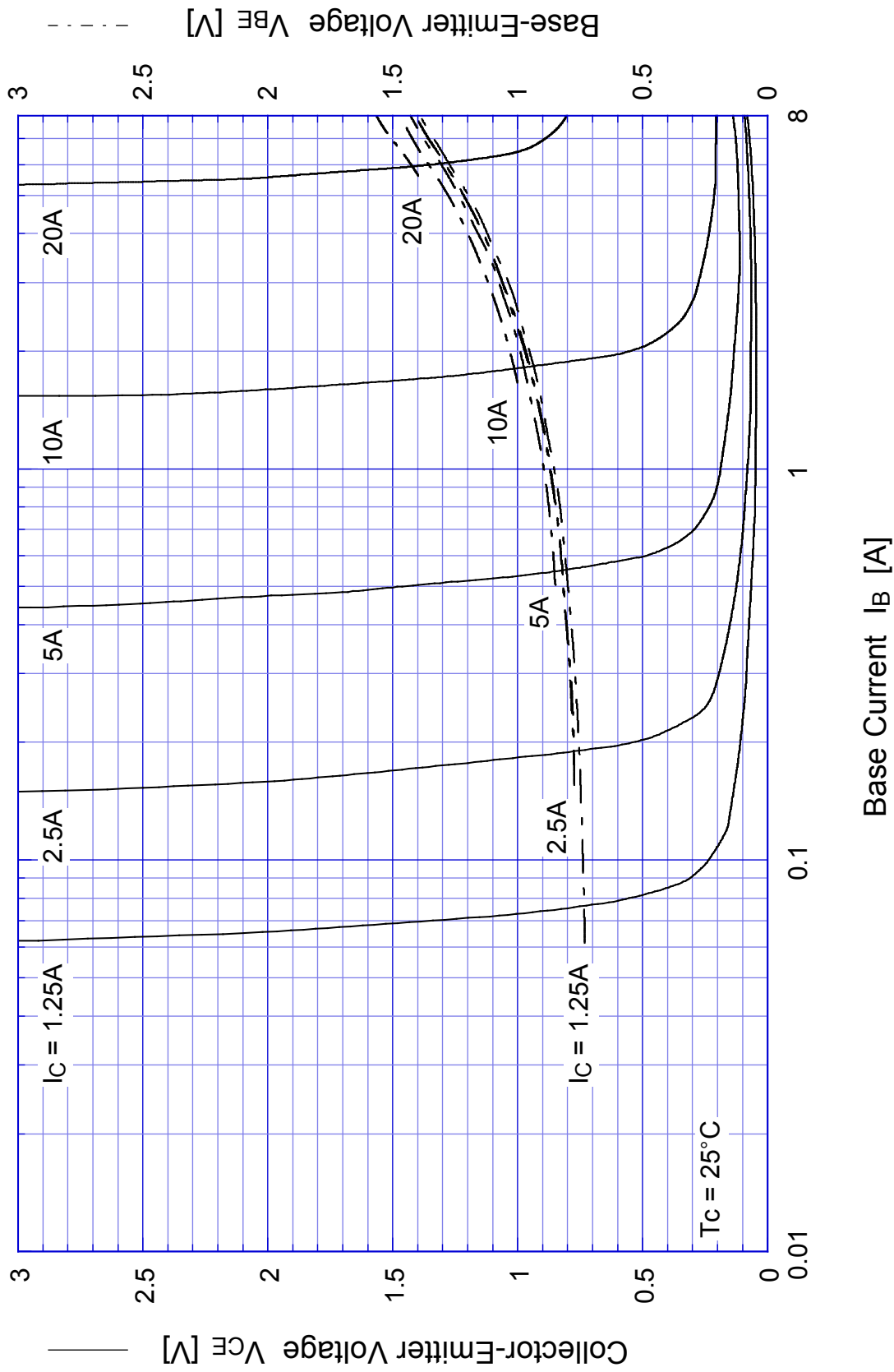

2SC4585

Switching Time - I_C

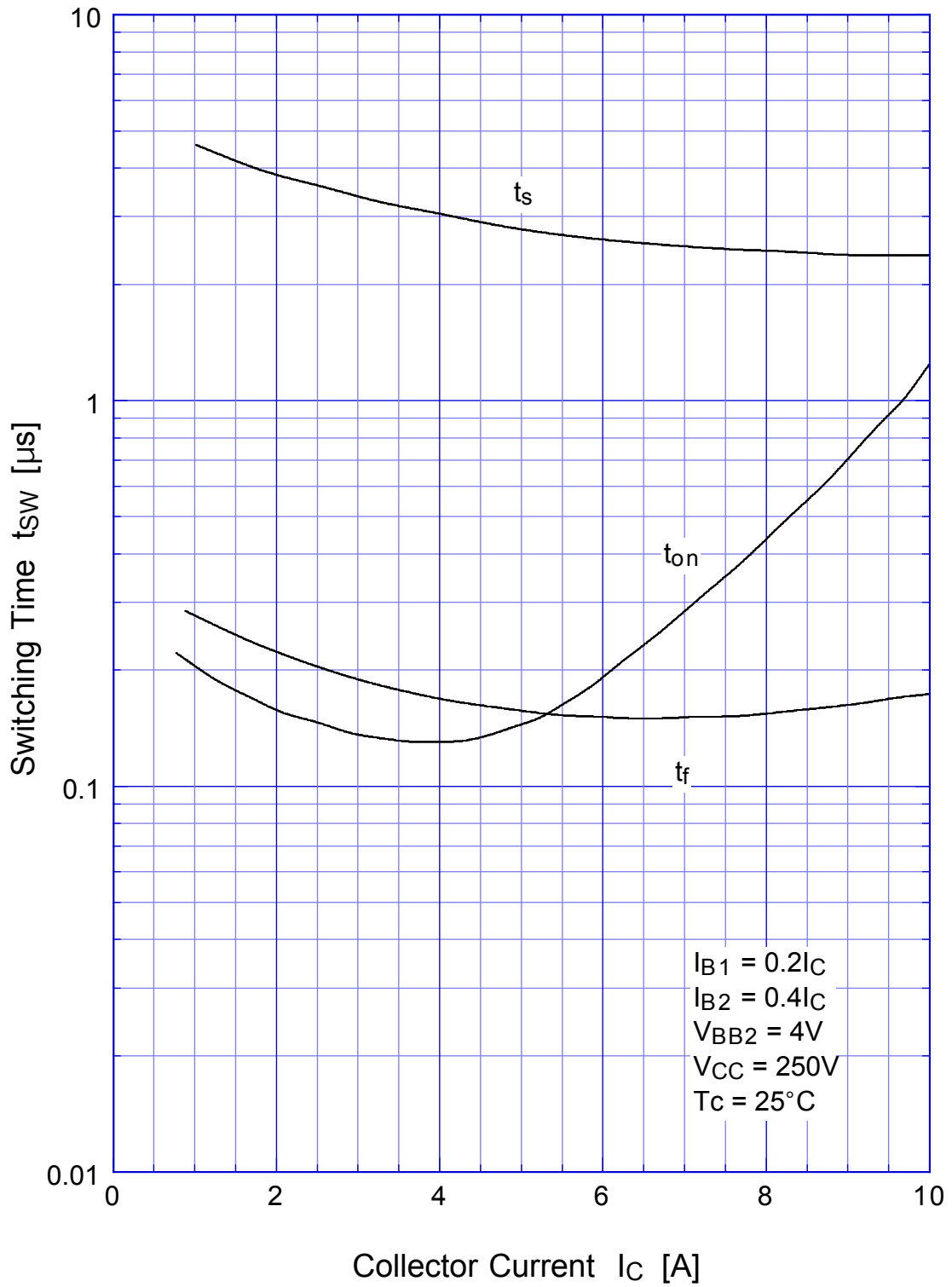

2SC4585 Switching Time - V_{CC}

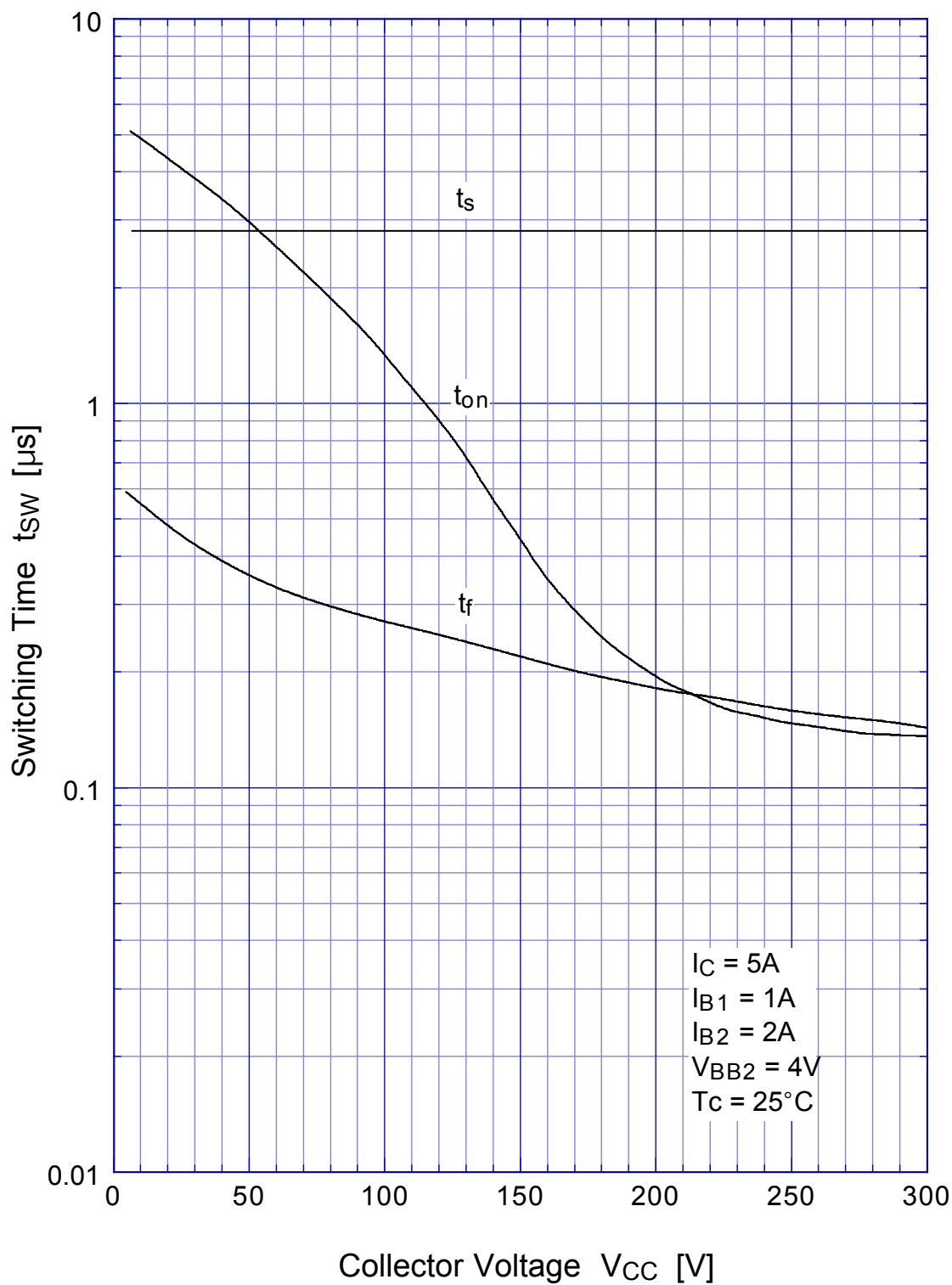

2SC4585

Switching Time - Tc

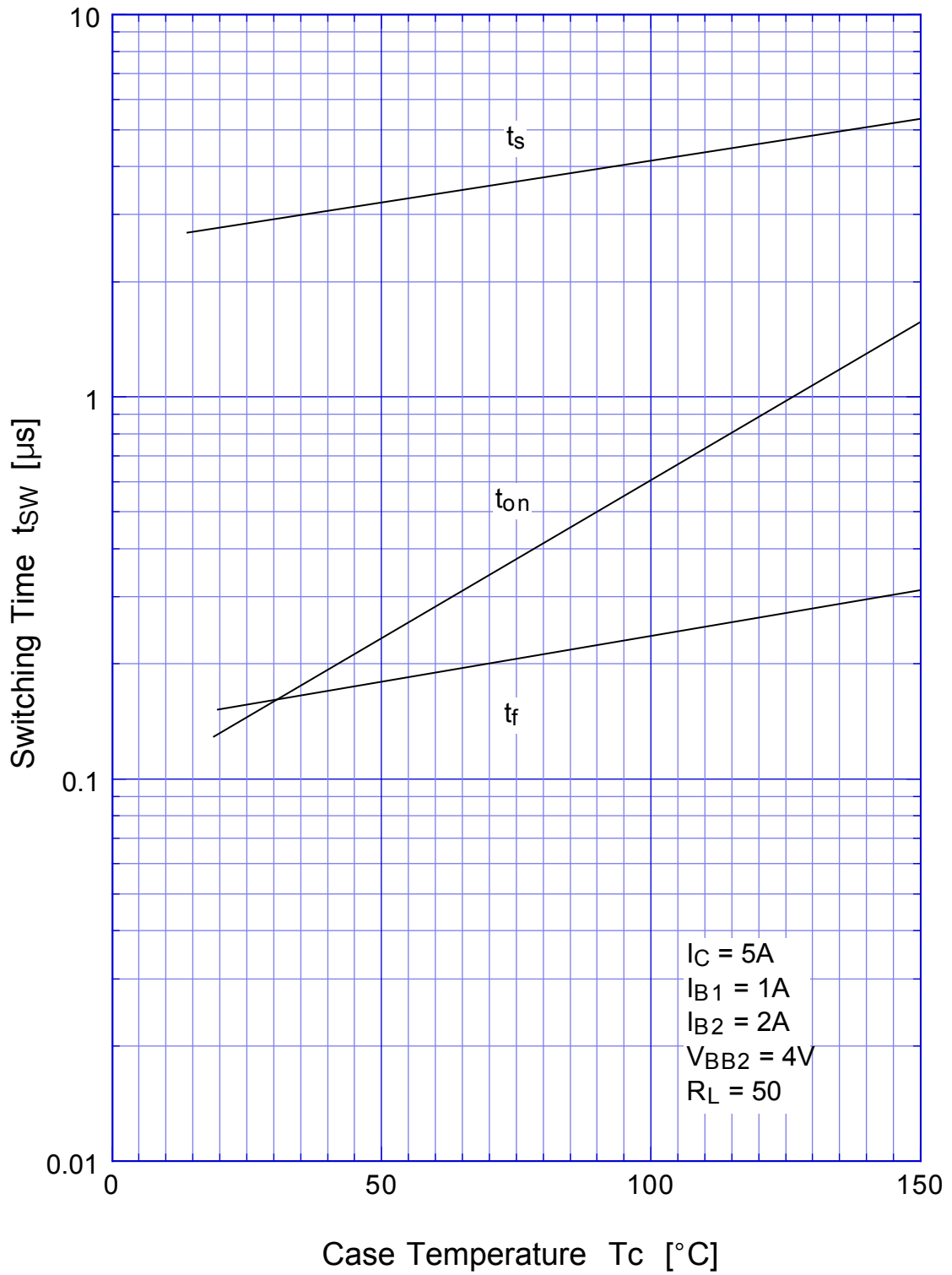

2SC4585 Transient Thermal Impedance

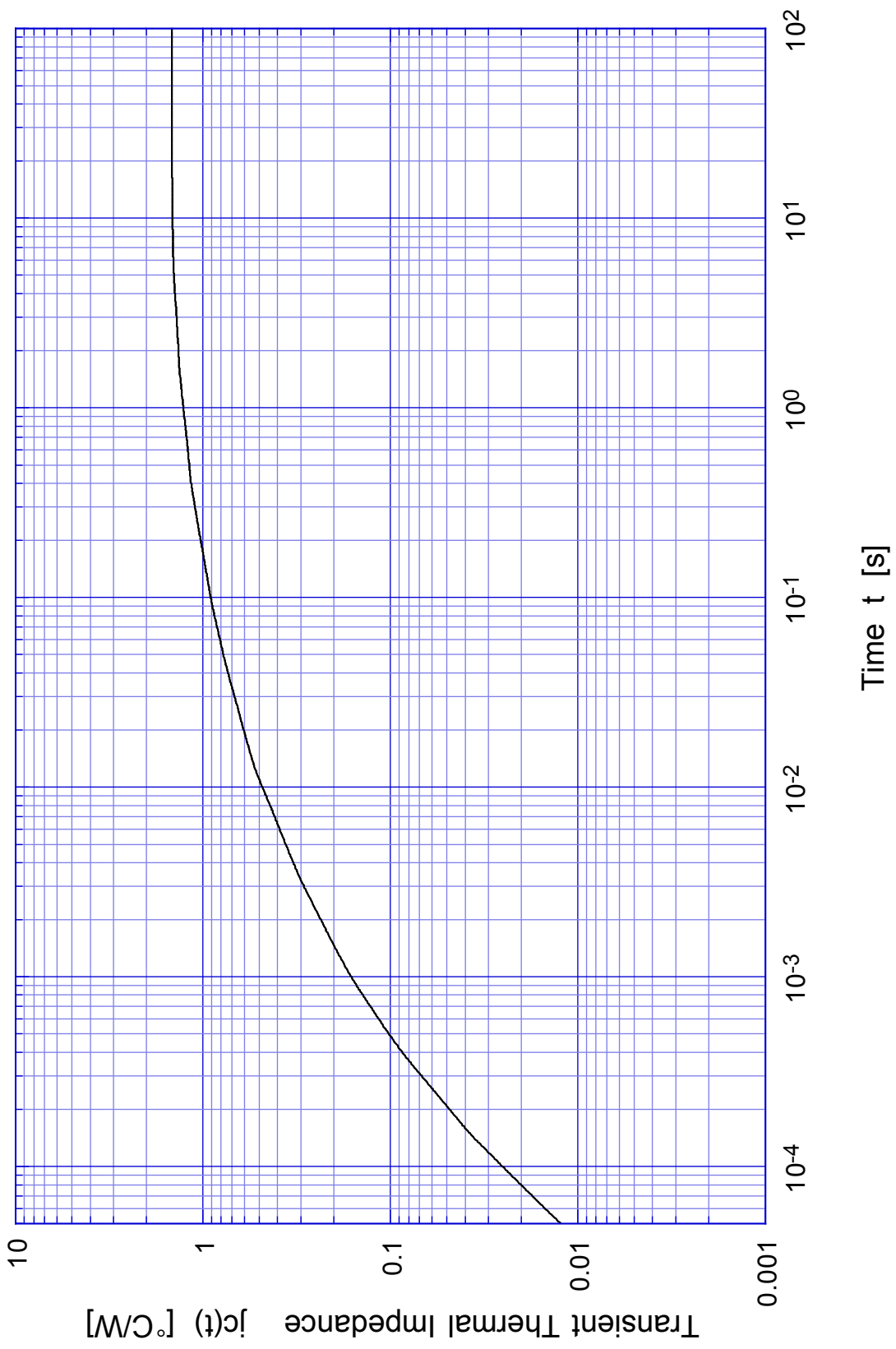

2SC4585 Forward Bias SOA

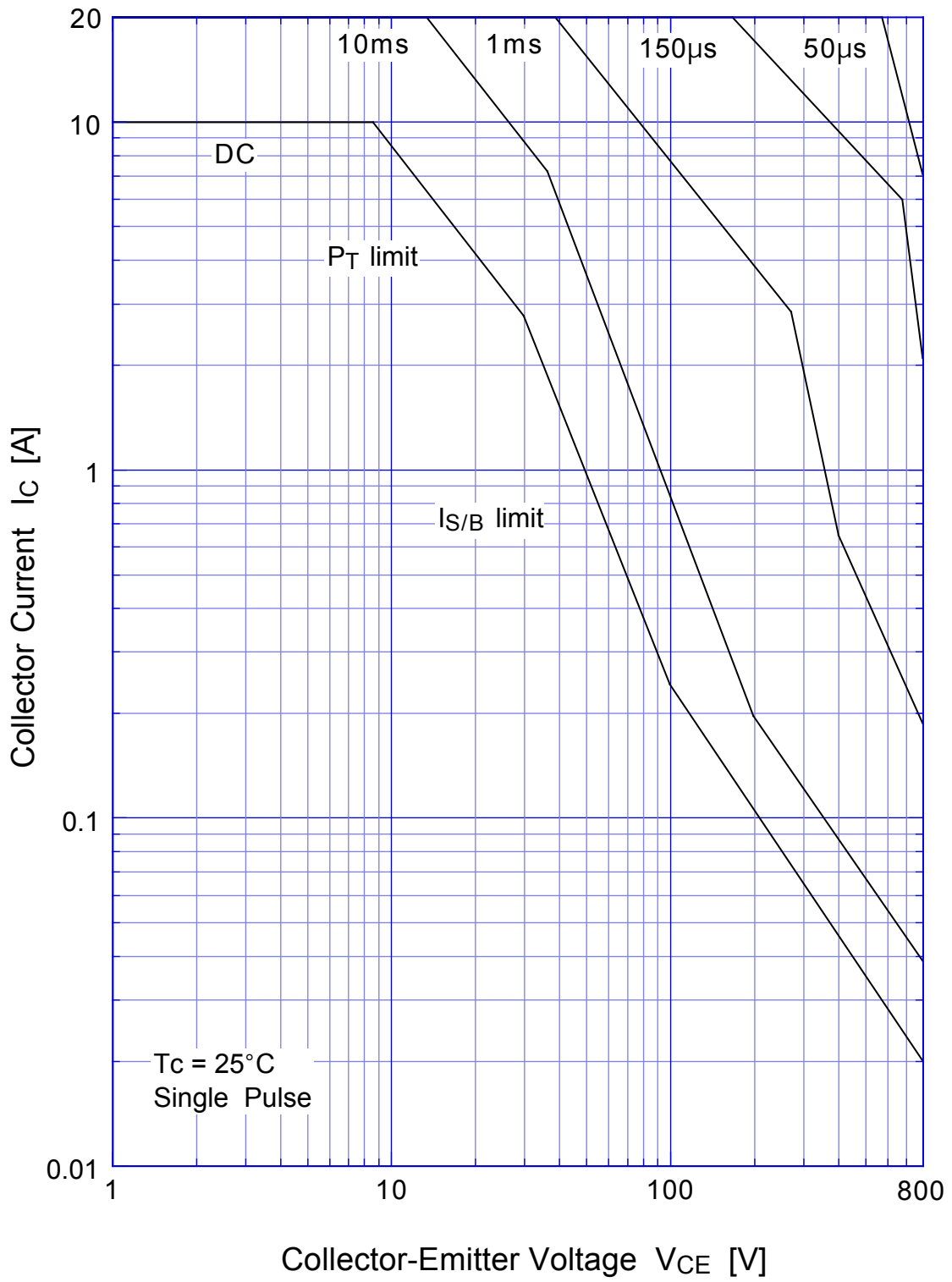

2SC4585 Collector Current Derating

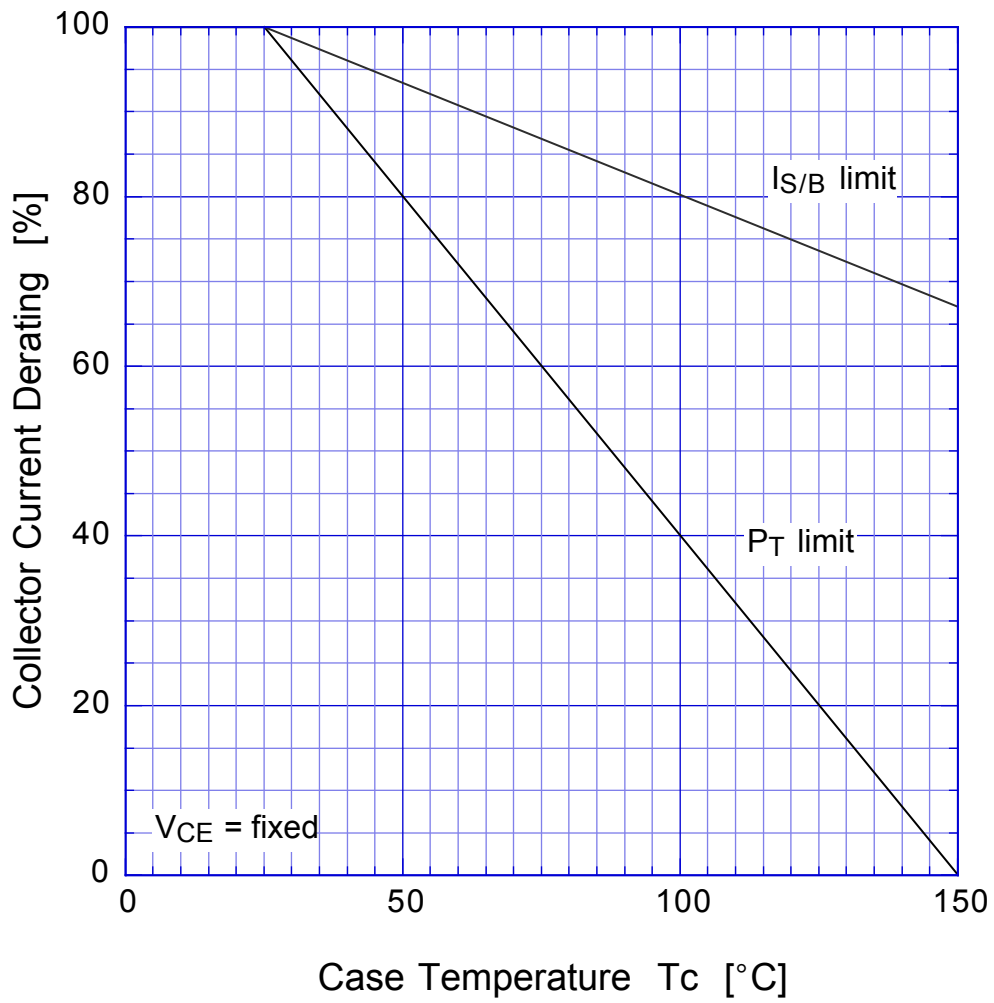

2SC4585

Reverse Bias SOA

