

# SHINDENGEN

## Schottky Rectifiers (SBD)

Single

# D1FS6

## 60V 1.1A

### FEATURES

- Small SMT
- Tj150°C
- P<sub>RRSM</sub> avalanche guaranteed

### APPLICATION

- Switching power supply
- DC/DC converter
- Home Appliances, Office Equipment
- Telecommunication

### OUTLINE DIMENSIONS

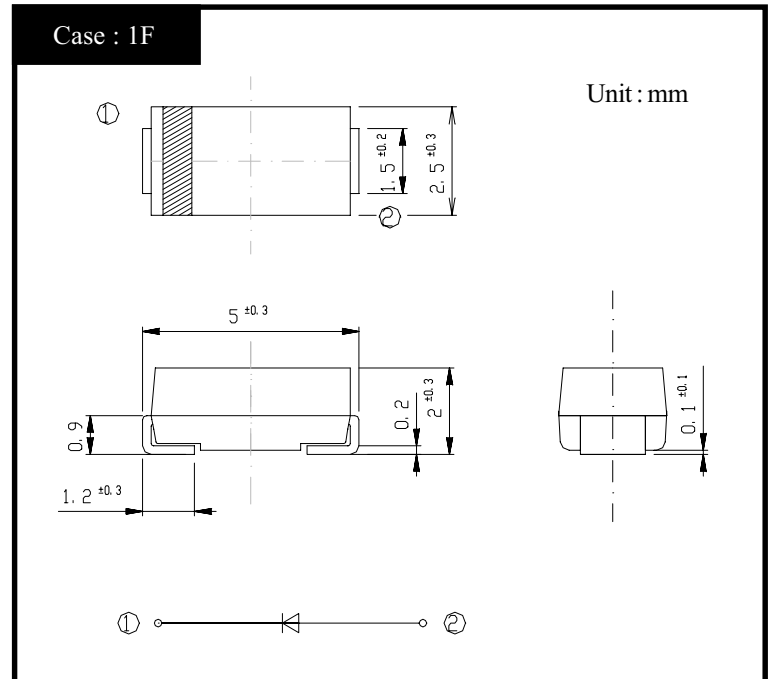

### RATINGS

- Absolute Maximum Ratings (If not specified Tl=25°C)

Item	Symbol	Conditions	Ratings	Unit
Storage Temperature	T <sub>stg</sub>		-55~150	°C
Operating Junction Temperature	T <sub>j</sub>		150	°C
Maximum Reverse Voltage	V <sub>RM</sub>		60	V
Repetitive Peak Surge Reverse Voltage	V <sub>RRSM</sub>	Pulse width 0.5ms, duty 1/40	65	V
Average Rectified Forward Current	I <sub>O</sub>	50Hz sine wave, R-load T <sub>a</sub> =25°C On alumina substrate	1.1	A
		50Hz sine wave, R-load T <sub>a</sub> =25°C On glass-epoxy substrate	0.82	
Peak Surge Forward Current	I <sub>FSM</sub>	50Hz sine wave, Non-repetitive 1 cycle peak value, T <sub>j</sub> =125°C	40	A
Repetitive Peak Surge Reverse Power	P <sub>RRSM</sub>	Pulse width 10 μs, T <sub>j</sub> =25°C	60	W

- Electrical Characteristics (If not specified Tl=25°C)

Item	Symbol	Conditions	Ratings	Unit
Forward Voltage	V <sub>F</sub>	I <sub>F</sub> =1.1A, Pulse measurement	Max.0.58	V
Reverse Current	I <sub>R</sub>	V <sub>R</sub> =V <sub>RM</sub> , Pulse measurement	Max.1	mA
Junction Capacitance	C <sub>j</sub>	f=1MHz, V <sub>R</sub> =10V	Typ.50	pF
Thermal Resistance	θ <sub>jl</sub>	junction to lead	Max.23	°C/W
	θ <sub>ja</sub>	junction to ambient On alumina substrate	Max.108	
		junction to ambient On glass-epoxy substrate	Max.157	

# D1FS6

## Forward Voltage

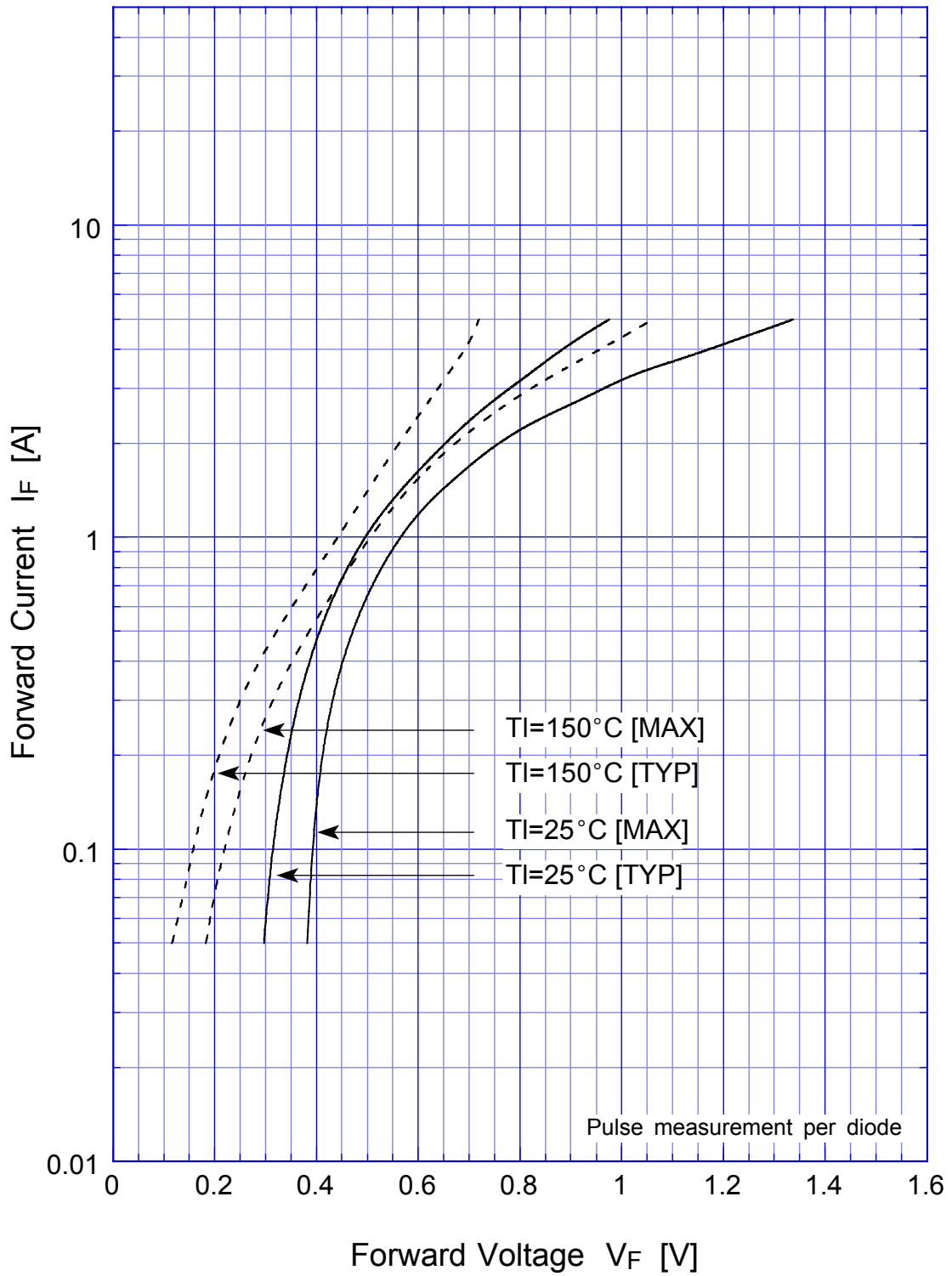

# D1FS6

## Junction Capacitance

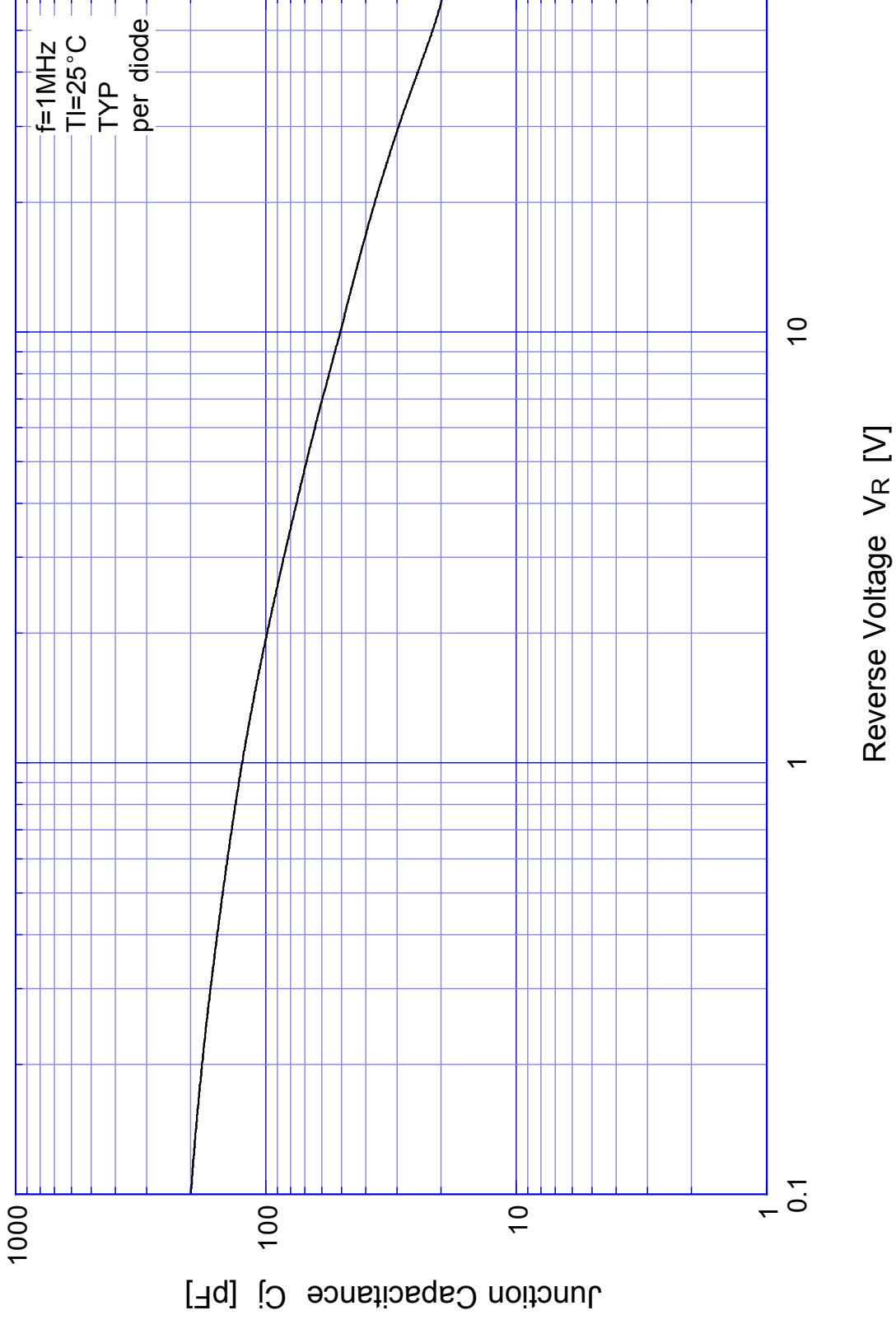

# D1FS6

## Reverse Current

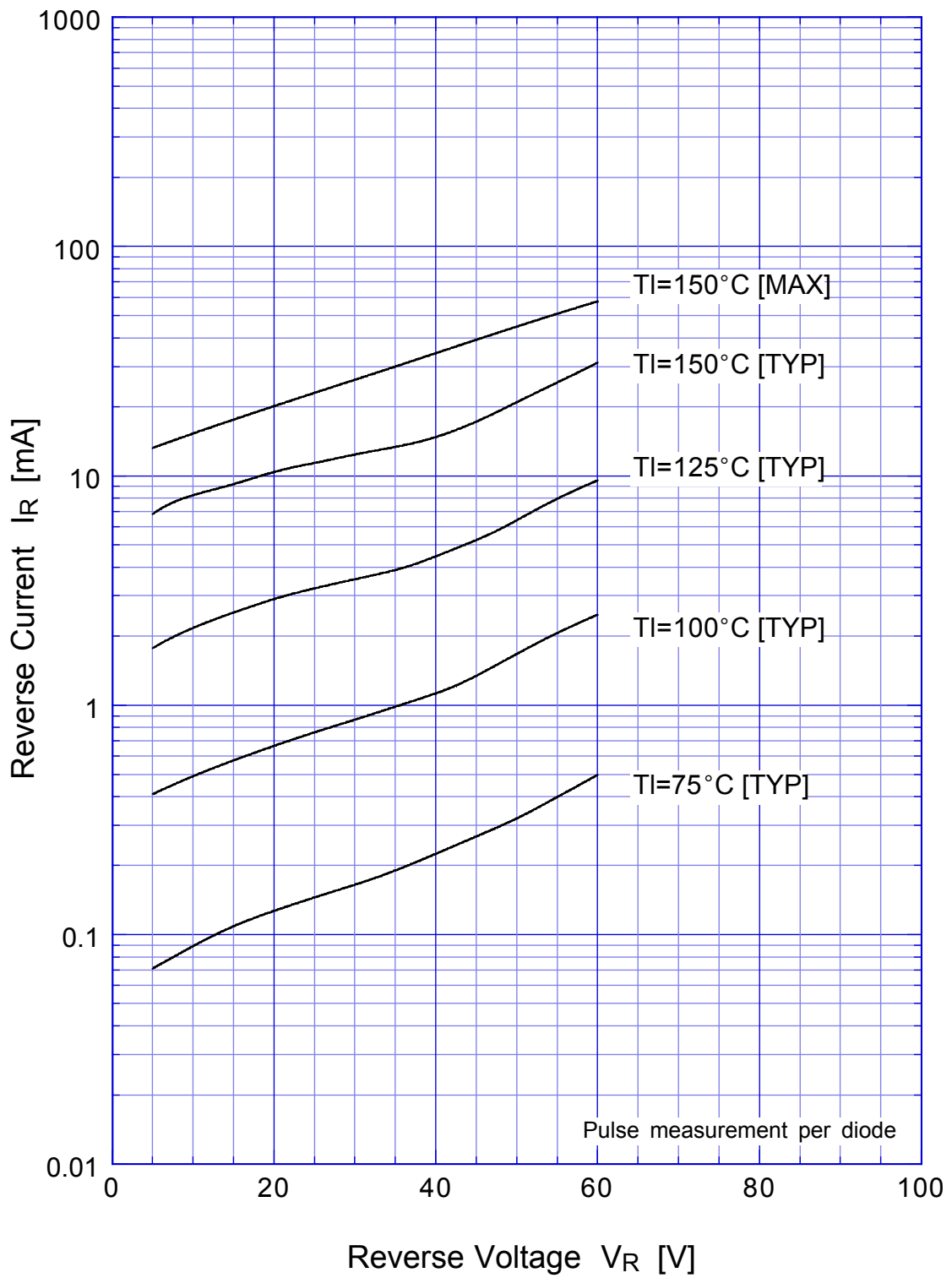

# D1FS6

## Reverse Power Dissipation

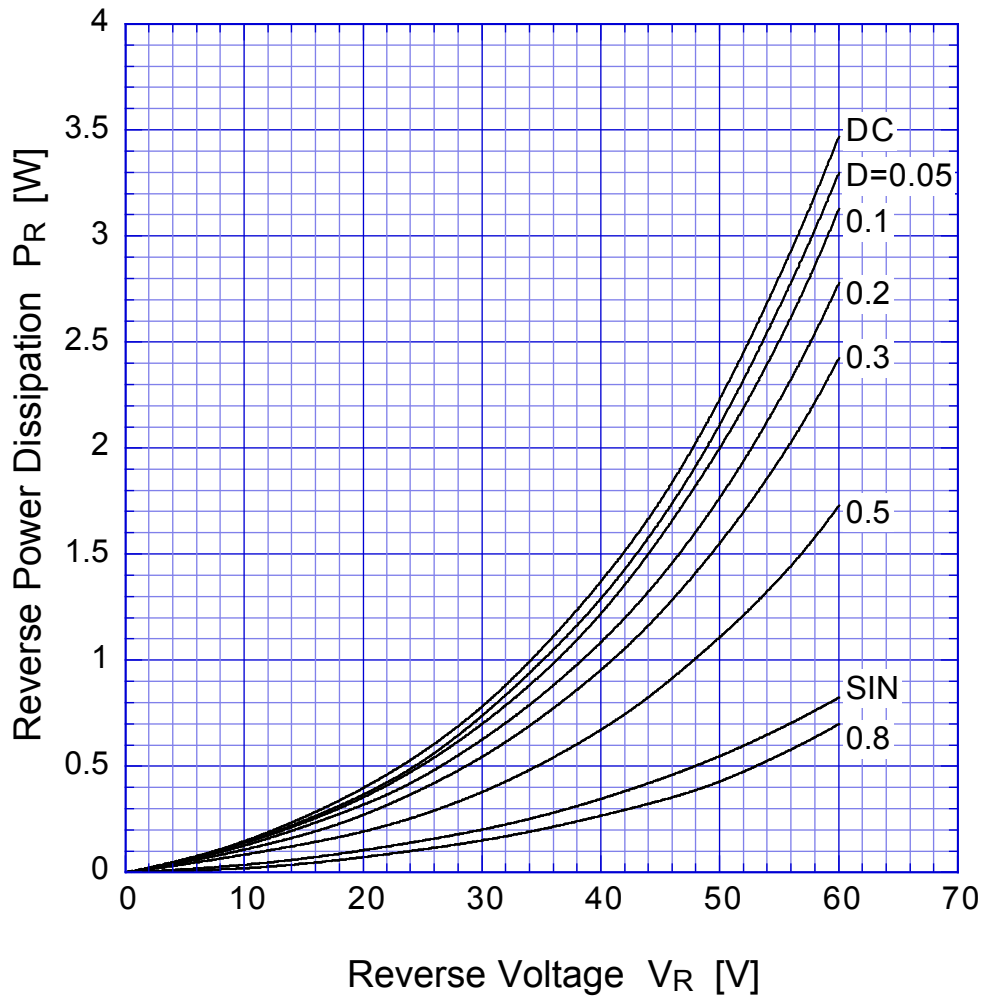

$T_j = 150^\circ\text{C}$

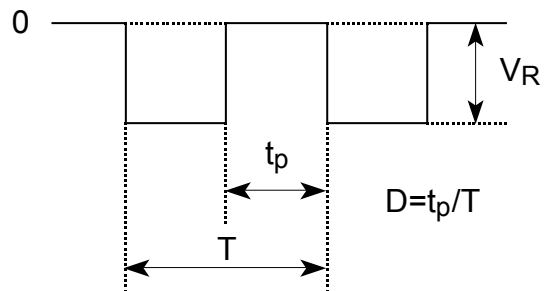

# D1FS6

## Forward Power Dissipation

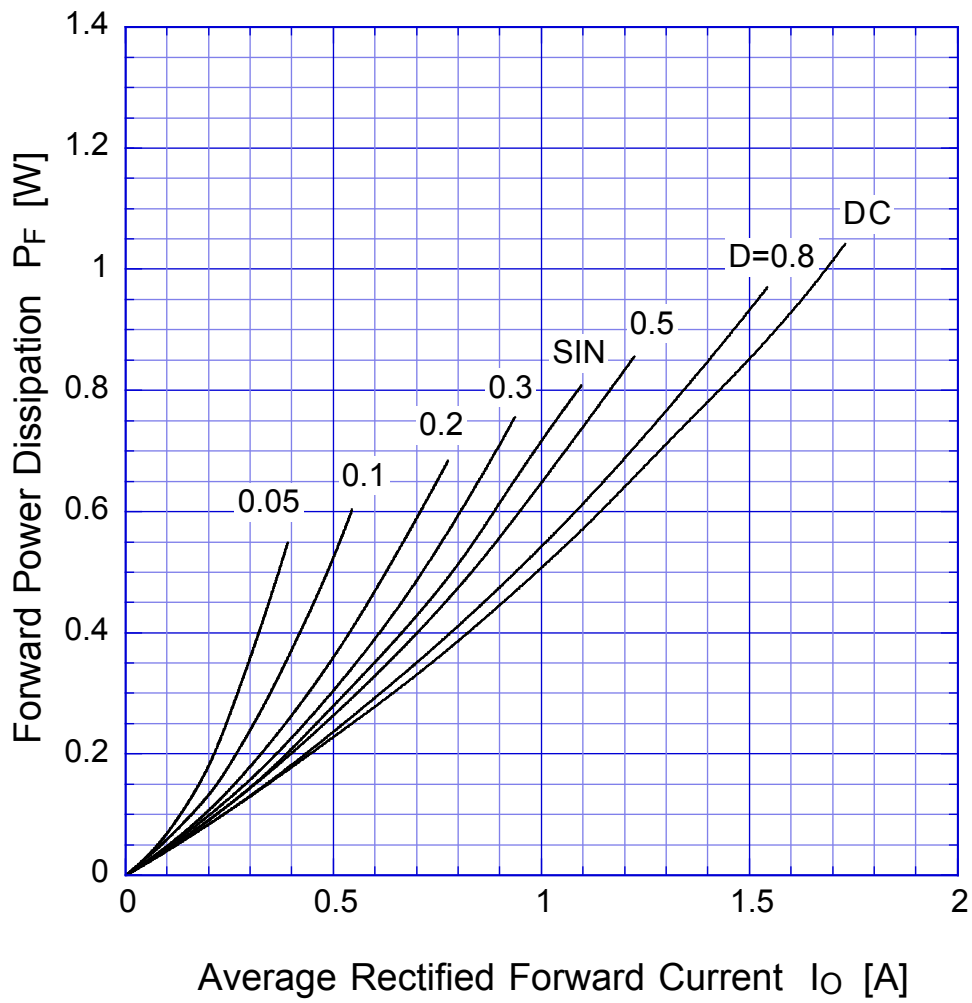

$T_j = 150^\circ\text{C}$

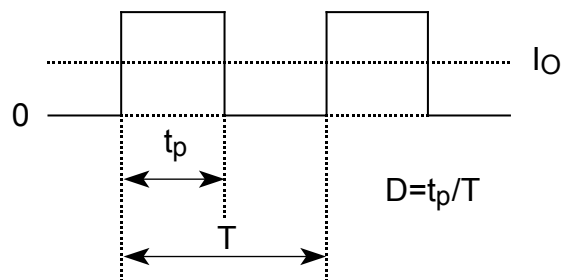

# D1FS6

# Derating Curve

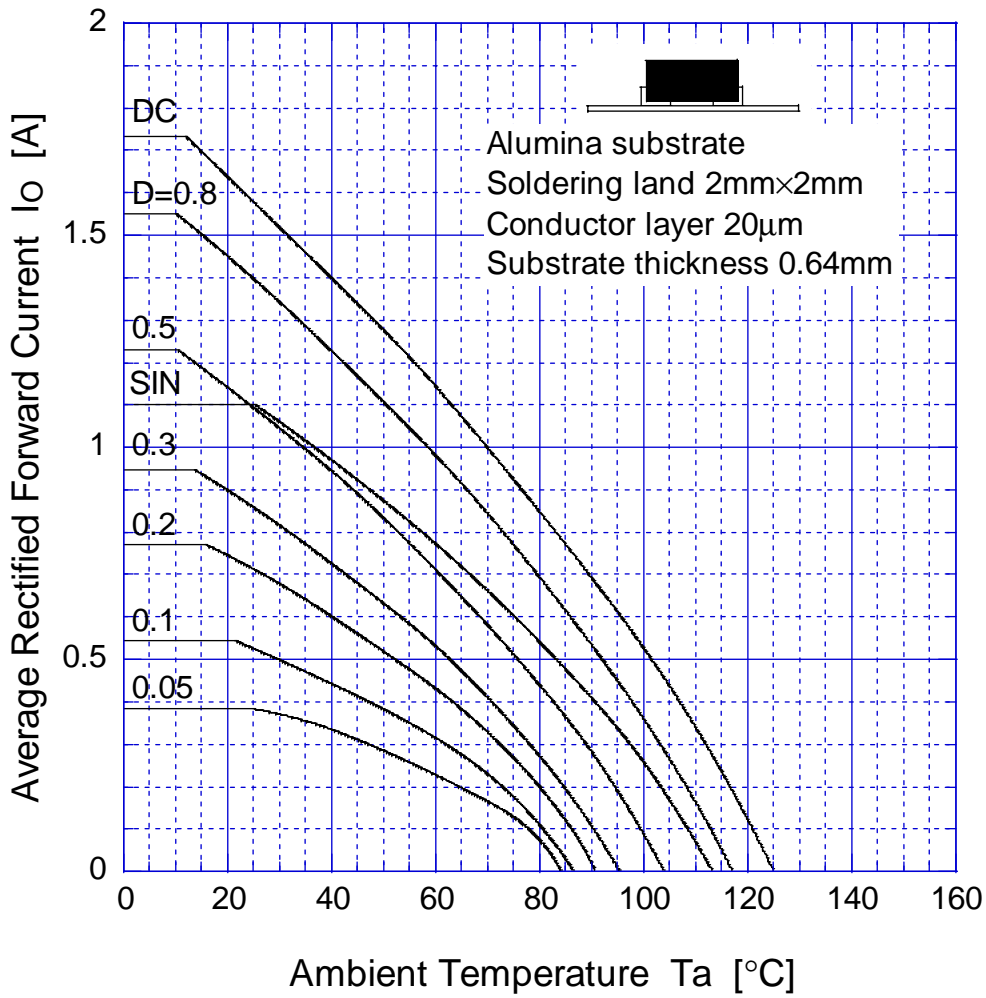

$V_R = 20V$

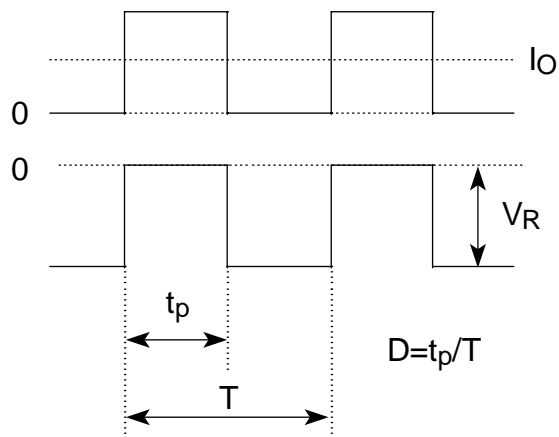

# D1FS6

# Derating Curve

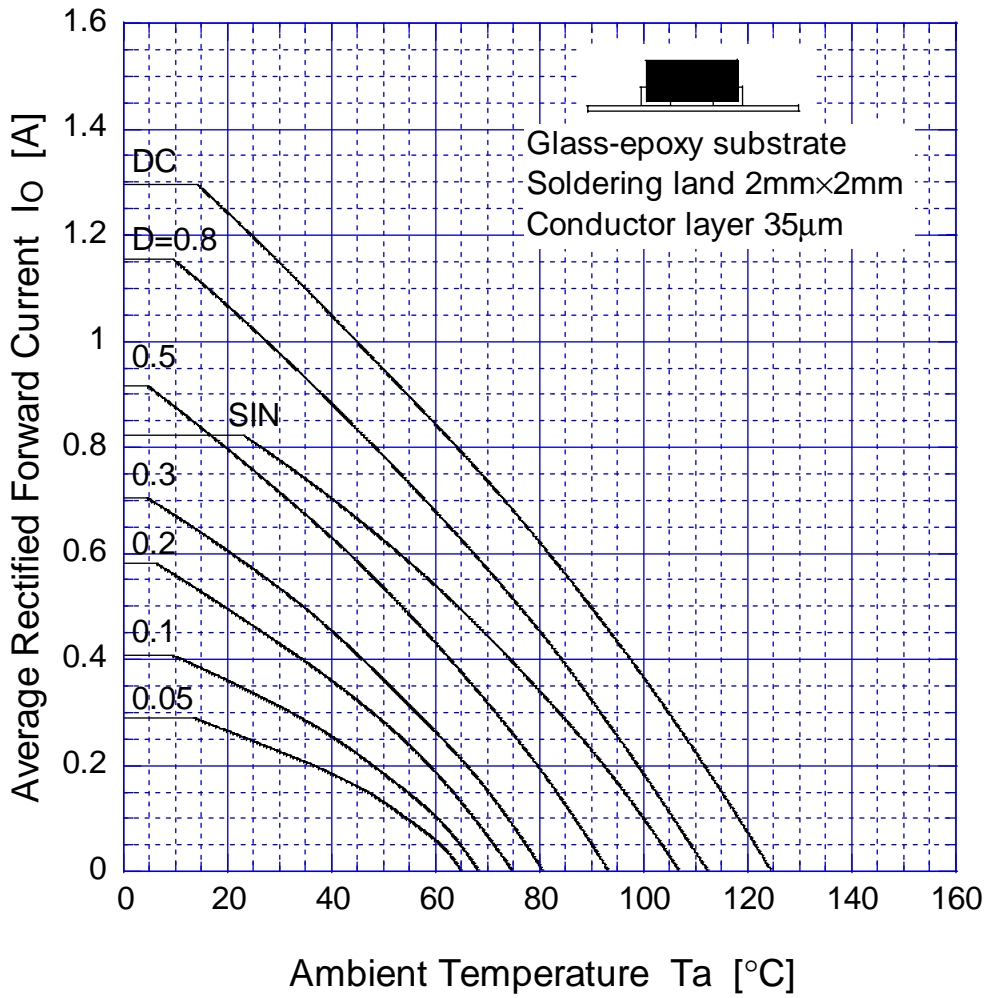

$V_R = 20V$

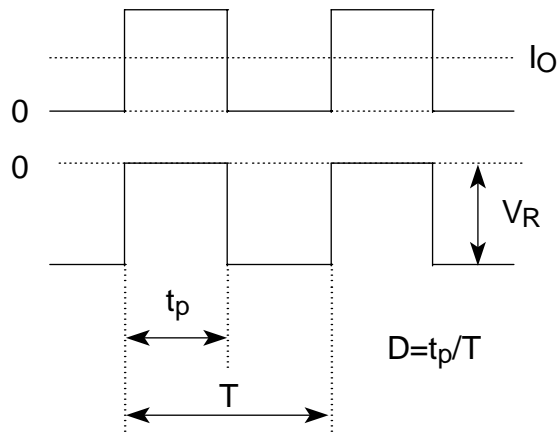

# D1FS6

## Peak Surge Forward Capability

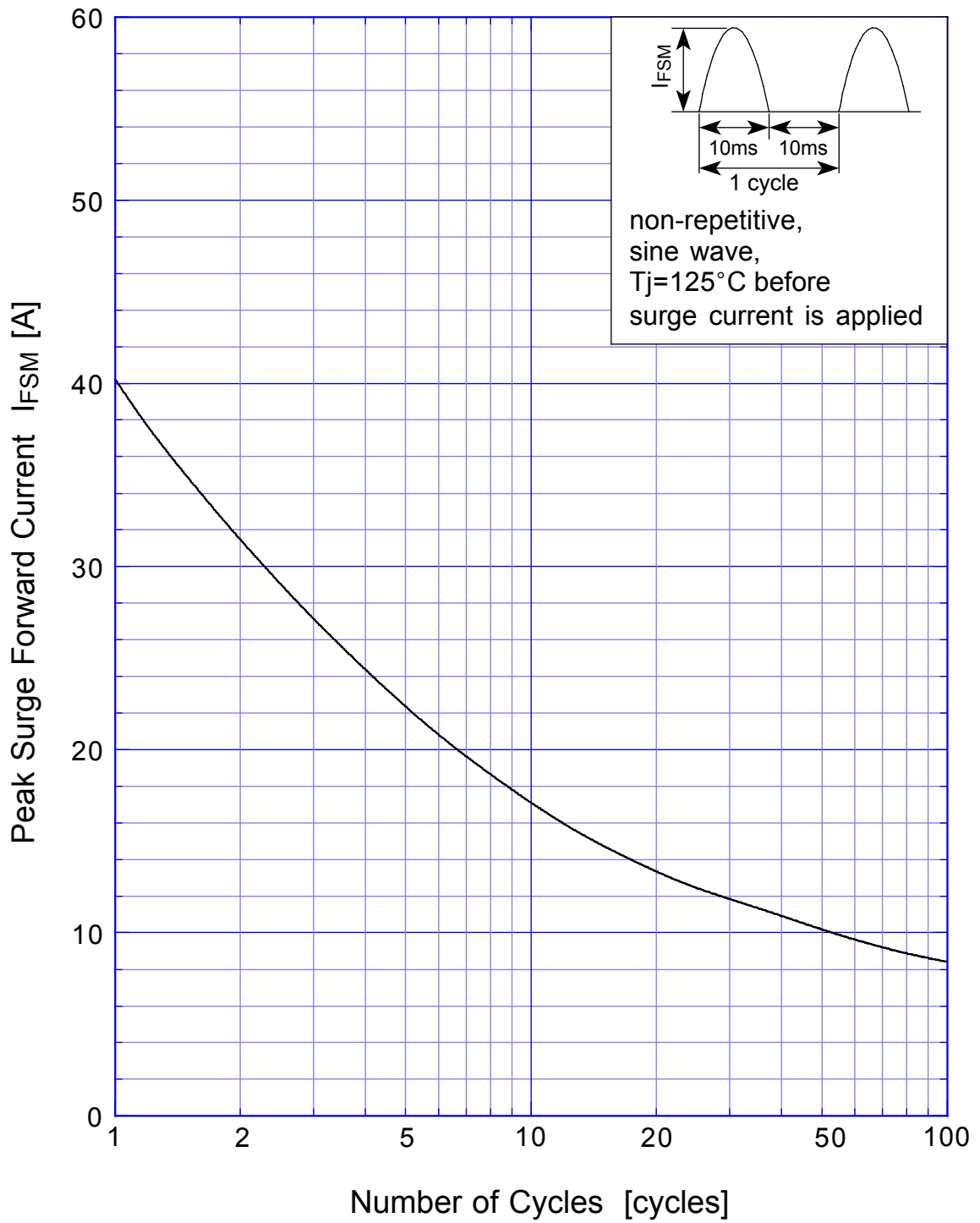

# SBD Repetitive Surge Reverse Power Derating Curve

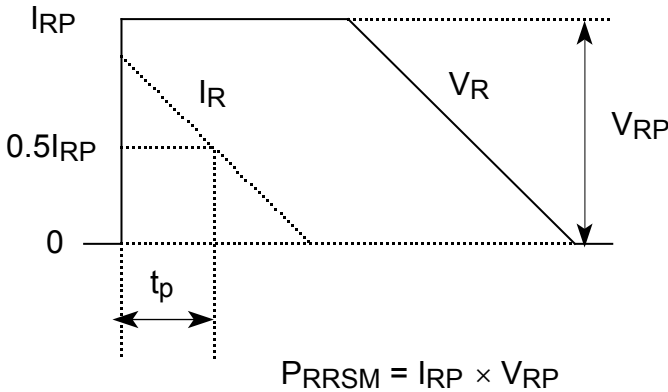

# SBD

## Repetitive Surge Reverse Power Capability

