

FEATURES

- xDSL Line Driver that Features Full ADSL CO (Central Office) Performance on ± 12 V Supplies
- Low Power Operation
 - ± 5 V to ± 12 V Voltage Supply
 - 12.5 mA/Amp (Typ) Total Supply Current
 - Power-Reduced Keep-Alive Current of 4.5 mA/Amp
- High Output Voltage and Current Drive
 - $I_{OUT} = 600$ mA
 - 40 V p-p Differential Output Voltage $R_L = 50 \Omega$, $V_S = \pm 12$ V
- Low Single Tone Distortion
 - 75 dBc @ 1 MHz SFDR, $R_L = 100 \Omega$, $V_O = 2$ V p-p
- MTPR = -75 dBc, 26 kHz to 1.1 MHz, $Z_{LINE} = 100 \Omega$, $P_{LINE} = 20.4$ dBm
- High Speed
 - 78 MHz Bandwidth (-3 dB), $G = +5$
 - 40 MHz Gain Flatness
 - 1000 V/ μ s Slew Rates

PRODUCT DESCRIPTION

The AD8016 high output current dual amplifier is designed for the line drive interface in Digital Subscriber Line systems such as ADSL, HDSL2, and proprietary xDSL systems. The drivers are capable, in full-bias operation, of providing 24.4 dBm output power into low resistance loads, enough to power a 20.4 dBm line, including hybrid insertion loss.

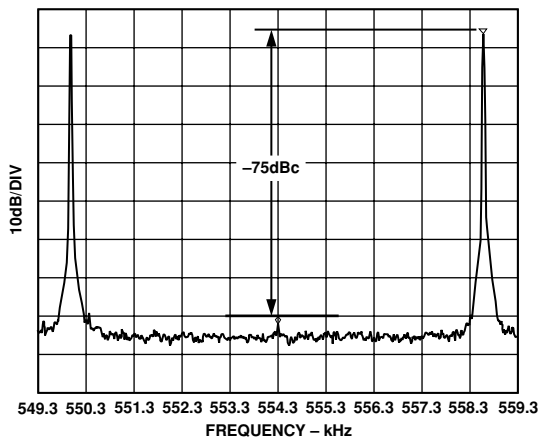
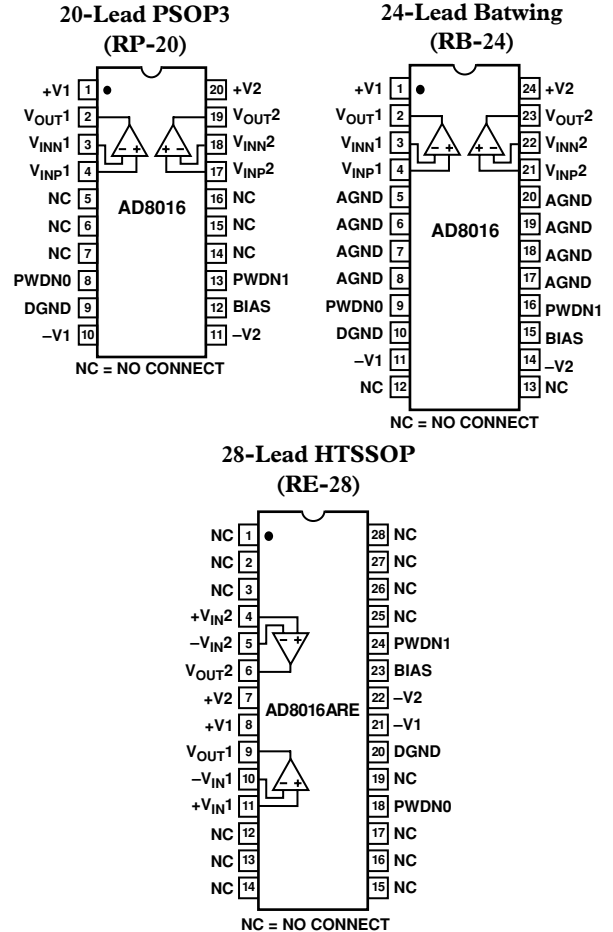

Figure 1. Multitone Power Ratio; $V_S = \pm 12$ V, 20.4 dBm Output Power into 100Ω , Downstream

REV. A

Information furnished by Analog Devices is believed to be accurate and reliable. However, no responsibility is assumed by Analog Devices for its use, nor for any infringements of patents or other rights of third parties which may result from its use. No license is granted by implication or otherwise under any patent or patent rights of Analog Devices.

PIN CONFIGURATION



The AD8016 is available in a low cost 24-lead SOIC, a thermally enhanced 20-lead PSOP, and a 28-lead HTSSOP with an exposed leadframe (ePAD). Operating from ± 12 V supplies, the AD8016 requires only 1.5 W of total power dissipation (refer to the Power Dissipation section for details) while driving 20.4 dBm of power downstream using the xDSL hybrid in Figure 33a and Figure 33b. Two digital bits (PWDN0, PWDN1) allow the driver to be capable of full performance, an output “keep-alive state,” or two intermediate bias states. The “keep-alive” state biases the output transistors enough to provide a low impedance at the amplifier outputs for back termination.

The low power dissipation, high output current, high output voltage swing, flexible power-down, and robust thermal packaging enable the AD8016 to be used as the Central Office (CO) terminal driver in ADSL, HDSL2, VDSL, and proprietary xDSL systems.

AD8016—SPECIFICATIONS (@ 25°C, V_S = ±12 V, R_L = 100 Ω, PWDN0, PWDN1 = (1, 1), T_{MIN} = -40°C, T_{MAX} = +85°C, unless otherwise noted)

| Parameter | Conditions | Min | Typ | Max | Unit |
|-------------------------------------|---|---------|---------|------|--------|
| DYNAMIC PERFORMANCE | | | | | |
| -3 dB Bandwidth | G = +1, R _F = 1.5 kΩ, V _{OUT} = 0.2 V p-p | | 380 | | MHz |
| Bandwidth for 0.1 dB Flatness | G = +5, R _F = 499 Ω, V _{OUT} < 0.5 V p-p | 69 | 78 | | MHz |
| Large Signal Bandwidth | G = +5, R _F = 499 Ω, V _{OUT} = 0.2 V p-p | 16 | 38 | | MHz |
| Peaking | V _{OUT} = 4 V p-p | | 90 | | MHz |
| Slew Rate | V _{OUT} = 0.2 V p-p < 50 MHz | | 0.1 | | dB |
| Rise and Fall Time | V _{OUT} = 4 V p-p, G = +2 | | 1000 | | V/μs |
| Settling Time | V _{OUT} = 2 V p-p | | 2 | | ns |
| Input Overdrive Recovery Time | 0.1%, V _{OUT} = 2 V p-p | | 23 | | ns |
| | V _{OUT} = 12.5 V p-p | | 350 | | ns |
| NOISE/DISTORTION PERFORMANCE | | | | | |
| Distortion, Single-Ended | V _{OUT} = 2 V p-p, G = +5, R _F = 499 Ω | | | | |
| 2nd Harmonic | f _C = 1 MHz, R _L = 100 Ω/25 Ω | -75/-62 | -77/-64 | | dBc |
| 3rd Harmonic | f _C = 1 MHz, R _L = 100 Ω/25 Ω | -88/-74 | -93/-76 | | dBc |
| Multitone Power Ratio ¹ | 26 kHz to 1.1 MHz, Z _{LINE} = 100 Ω, P _{LINE} = 20.4 dBm | | -75 | | dBc |
| IMD | 500 kHz, Δf = 10 kHz, R _L = 100 Ω/25 Ω | -84/-80 | -88/-85 | | dBc |
| IP3 | 500 kHz, R _L = 100 Ω/25 Ω | 42/40 | 43/41 | | dBm |
| Voltage Noise (RTI) | f = 10 kHz | | 2.6 | 4.5 | nV/√Hz |
| Input Current Noise | f = 10 kHz | | 18 | 21 | pA/√Hz |
| INPUT CHARACTERISTICS | | | | | |
| RTI Offset Voltage | | -3.0 | 1.0 | +3.0 | mV |
| +Input Bias Current | | -45 | | +45 | μA |
| -Input Bias Current | | -75 | 4 | +75 | μA |
| Input Resistance | | | 400 | | kΩ |
| Input Capacitance | | | 2 | | pF |
| Input Common-Mode Voltage Range | | -10 | | +10 | V |
| Common-Mode Rejection Ratio | | 58 | 64 | | dB |
| OUTPUT CHARACTERISTICS | | | | | |
| Output Voltage Swing | Single-Ended, R _L = 100 Ω | -11 | | +11 | V |
| Linear Output Current | G = 5, R _L = 10 Ω, f ₁ = 100 kHz, -60 dBc SFDR | 400 | 600 | | mA |
| Short Circuit Current | | | 2000 | | mA |
| Capacitive Load Drive | | | 80 | | pF |
| POWER SUPPLY | | | | | |
| Operating Range | | ±3 | | ±13 | V |
| Quiescent Current | PWDN1, PWDN0 = (1, 1) | | 12.5 | 13.2 | mA/Amp |
| | (1, 0) | | 8 | 10 | mA/Amp |
| | (0, 1) | | 5 | 8 | mA/Amp |
| | (0, 0) | | 4 | 6 | mA/Amp |
| Recovery Time | T ₀ 95% of I _Q | | 25 | | μs |
| Shutdown Current | 250 μA Out of Bias Pin | | 1.5 | 4.0 | mA/Amp |
| Power Supply Rejection Ratio | ΔV _S = ±1 V | 63 | 75 | | dB |
| OPERATING TEMPERATURE RANGE | | | | | |
| | | -40 | | +85 | °C |

NOTES

¹See Figure 43, R20, R21 = 0 Ω, R1 = open.

Specifications subject to change without notice.

SPECIFICATIONS

(@ 25°C, $V_S = \pm 6\text{ V}$, $R_L = 100\ \Omega$, PWDN0, PWDN1 = (1, 1), $T_{\text{MIN}} = -40^\circ\text{C}$, $T_{\text{MAX}} = +85^\circ\text{C}$, unless otherwise noted)

| Parameter | Conditions | Min | Typ | Max | Unit |
|-------------------------------------|--|---------|---------|------|------------------------|
| DYNAMIC PERFORMANCE | | | | | |
| -3 dB Bandwidth | $G = +1$, $R_F = 1.5\ \text{k}\Omega$, $V_{\text{OUT}} = 0.2\ \text{V p-p}$ | | 320 | | MHz |
| | $G = +5$, $R_F = 499\ \Omega$, $V_{\text{OUT}} < 0.5\ \text{V p-p}$ | 70 | 71 | | MHz |
| Bandwidth for 0.1 dB Flatness | $G = +5$, $R_F = 499\ \Omega$, $V_{\text{OUT}} = 0.2\ \text{V p-p}$ | 10 | 15 | | MHz |
| Large Signal Bandwidth | $V_{\text{OUT}} = 1\ \text{V rms}$ | | 80 | | MHz |
| Peaking | $V_{\text{OUT}} = 0.2\ \text{V p-p} < 50\ \text{MHz}$ | | 0.7 | 1.0 | dB |
| Slew Rate | $V_{\text{OUT}} = 4\ \text{V p-p}$, $G = +2$ | | 300 | | V/ μs |
| Rise and Fall Time | $V_{\text{OUT}} = 2\ \text{V p-p}$ | | 2 | | ns |
| Settling Time | 0.1%, $V_{\text{OUT}} = 2\ \text{V p-p}$ | | 39 | | ns |
| Input Overdrive Recovery Time | $V_{\text{OUT}} = 6.5\ \text{V p-p}$ | | 350 | | ns |
| NOISE/DISTORTION PERFORMANCE | | | | | |
| Distortion, Single-Ended | $G = +5$, $V_{\text{OUT}} = 2\ \text{V p-p}$, $R_F = 499\ \Omega$ | | | | |
| 2nd Harmonic | $f_C = 1\ \text{MHz}$, $R_L = 100\ \Omega/25\ \Omega$ | -73/61 | -75/-63 | | dBc |
| 3rd Harmonic | $f_C = 1\ \text{MHz}$, $R_L = 100\ \Omega/25\ \Omega$ | -80/-68 | -82/-70 | | dBc |
| Multitone Power Ratio ¹ | 26 kHz to 138 kHz, $Z_{\text{LINE}} = 100\ \Omega$, $P_{\text{LINE}} = 13\ \text{dBm}$ | | -68 | | dBc |
| IMD | 500 kHz, $\Delta f = 110\ \text{kHz}$, $R_L = 100\ \Omega/25\ \Omega$ | -87/-82 | -88/-83 | | dBc |
| IP3 | 500 kHz | 42/39 | 42/39 | | dBm |
| Voltage Noise (RTI) | $f = 10\ \text{kHz}$ | | 4 | 5 | nV/ $\sqrt{\text{Hz}}$ |
| Input Current Noise | $f = 10\ \text{kHz}$ | | 17 | 20 | pA/ $\sqrt{\text{Hz}}$ |
| INPUT CHARACTERISTICS | | | | | |
| RTI Offset Voltage | | -3.0 | 0.2 | +3.0 | mV |
| +Input Bias Current | | -25 | 10 | +25 | μA |
| -Input Bias Current | | -30 | 10 | +30 | μA |
| Input Resistance | | | 400 | | k Ω |
| Input Capacitance | | | 2 | | pF |
| Input Common-Mode Voltage Range | | -4 | | +4 | V |
| Common-Mode Rejection Ratio | | 60 | 66 | | dB |
| OUTPUT CHARACTERISTICS | | | | | |
| Output Voltage Swing | Single-Ended, $R_L = 100\ \Omega$ | -5 | | +5 | V |
| Linear Output Current | $G = 5$, $R_L = 5\ \Omega$, $f = 100\ \text{kHz}$, -60 dBc SFDR | 300 | 420 | | mA |
| Short Circuit Current | | | 830 | | mA |
| Capacitive Load Drive | $R_S = 10\ \Omega$ | | 50 | | pF |
| POWER SUPPLY | | | | | |
| Quiescent Current | PWDN1, PWDN0 = (1, 1) | | 8 | 9.7 | mA/Amp |
| | (1, 0) | | 6 | 6.9 | mA/Amp |
| | (0, 1) | | 4 | 5.0 | mA/Amp |
| | (0, 0) | | 3 | 4.1 | mA/Amp |
| Recovery Time | To 95% of I_Q | | 23 | | μs |
| Shutdown Current | 250 μA Out of Bias Pin | | 1.0 | 2.0 | mA/Amp |
| Power Supply Rejection Ratio | $\Delta V_S = \pm 1\ \text{V}$ | 63 | 80 | | dB |
| OPERATING TEMPERATURE RANGE | | | | | |
| | | -40 | | +85 | $^\circ\text{C}$ |

NOTES

¹See Figure 43, R20, R21 = 0 Ω , R1 = open.

Specifications subject to change without notice.

LOGIC INPUTS (CMOS-Compatible Logic) (PWDN0, PWDN1, $V_{\text{CC}} = \pm 12\ \text{V}$ or $\pm 6\ \text{V}$; Full Temperature Range)

| Parameter | Min | Typ | Max | Unit |
|-------------------|-----|-----|-------------------|------|
| Logic "1" Voltage | 2.2 | | + V_{CC} | V |
| Logic "0" Voltage | 0 | | 0.8 | V |

AD8016

ABSOLUTE MAXIMUM RATINGS¹

| | |
|---|-------------------------------|
| Supply Voltage | 26.4 V |
| Internal Power Dissipation | |
| PSOP3 Package ² | 2.2 W |
| Batwing Package ³ | 1.4 W |
| EPAD Package ⁴ | 1.4 W |
| Input Voltage (Common-Mode) | $\pm V_S$ |
| Differential Input Voltage | $\pm V_S$ |
| Output Short Circuit Duration | Observe Power Derating Curves |
| Storage Temperature Range | -65°C to +125°C |
| Operating Temperature Range | -40°C to +85°C |
| Lead Temperature Range (Soldering 10 sec) | 300°C |

NOTES

- ¹Stresses above those listed under Absolute Maximum Ratings may cause permanent damage to the device. This is a stress rating only; functional operation of the device at these or any other conditions above those indicated in the operational section of this specification is not implied. Exposure to absolute maximum rating conditions for extended periods may affect device reliability.
- ²Specification is for device on a four-layer board with 10 inches² of 1 oz. copper at 85°C 20-lead PSOP3 package: $\theta_{JA} = 18^\circ\text{C}/\text{W}$.
- ³Specification is for device on a four-layer board with 10 inches² of 1 oz. copper at 85°C 24-lead Batwing package: $\theta_{JA} = 28^\circ\text{C}/\text{W}$.
- ⁴Specification is for device on a four-layer board with 9 inches² of 1 oz. copper at 85°C 28-lead (EPAD) package: $\theta_{JA} = 29^\circ\text{C}/\text{W}$.

MAXIMUM POWER DISSIPATION

The maximum power that can be safely dissipated by the AD8016 is limited by the associated rise in junction temperature. The maximum safe junction temperature for plastic encapsulated device is determined by the glass transition temperature of the plastic, approximately 150°C. Temporarily exceeding this limit may cause a shift in parametric performance due to a change in the stresses exerted on the die by the package.

The output stage of the AD8016 is designed for maximum load current capability. As a result, shorting the output to common can cause the AD8016 to source or sink 2000 mA. To ensure proper operation, it is necessary to observe the maximum power derating curves. Direct connection of the output to either power supply rail can destroy the device.

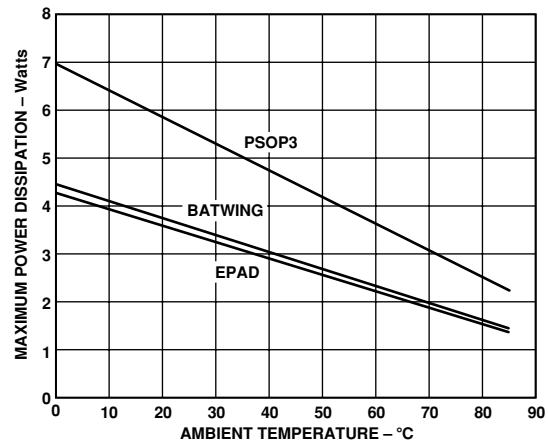

Figure 2. Plot of Maximum Power Dissipation vs. Temperature for AD8016 for $T_J = 125^\circ\text{C}$

ORDERING GUIDE

| Model | Temperature Range | Package Description | Package Option |
|----------------|-------------------|---------------------|----------------|
| AD8016ARP | -40°C to +85°C | 20-Lead PSOP3 | RP-20 |
| AD8016ARP-Reel | -40°C to +85°C | 20-Lead PSOP3 | ARP-Reel |
| AD8016ARP-EVAL | -40°C to +85°C | Evaluation Board | ARP-EVAL |
| AD8016ARB | -40°C to +85°C | 24-Lead Batwing | RB-24 |
| AD8016ARB-Reel | -40°C to +85°C | 24-Lead Batwing | ARB-Reel |
| AD8016ARB-EVAL | -40°C to +85°C | Evaluation Board | ARB-EVAL |
| AD8016ARE | -40°C to +85°C | 28-Lead HTSSOP | RE-28 |
| AD8016ARE-Reel | -40°C to +85°C | 28-Lead HTSSOP | ARE-Reel |
| AD8016ARE-EVAL | -40°C to +85°C | Evaluation Board | ARE-EVAL |

CAUTION

ESD (electrostatic discharge) sensitive device. Electrostatic charges as high as 4000 V readily accumulate on the human body and test equipment and can discharge without detection. Although the AD8016 features proprietary ESD protection circuitry, permanent damage may occur on devices subjected to high-energy electrostatic discharges. Therefore, proper ESD precautions are recommended to avoid performance degradation or loss of functionality.



Typical Performance Characteristics—AD8016

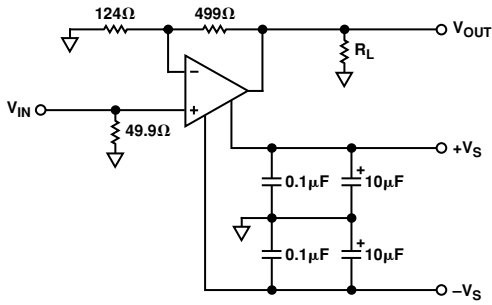

Figure 3. Single-Ended Test Circuit; $G = +5$

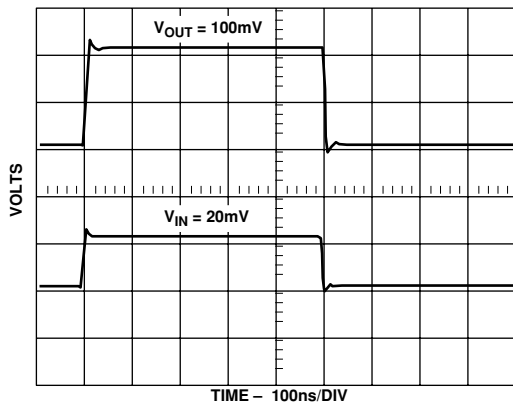

Figure 4. 100 mV Step Response; $G = +5$, $V_S = \pm 6$ V, $R_L = 25$ Ω , Single-Ended

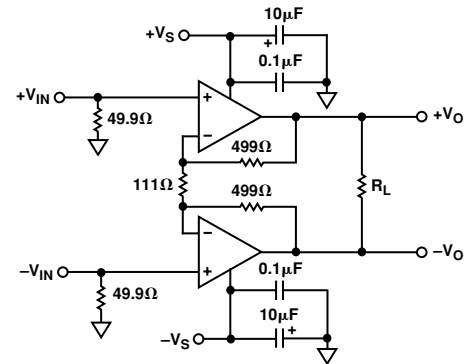

Figure 6. Differential Test Circuit; $G = +10$

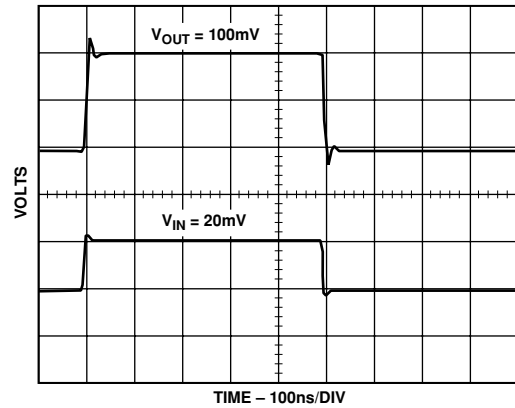

Figure 7. 100 mV Step Response; $G = +5$, $V_S = \pm 12$ V, $R_L = 25$ Ω , Single-Ended

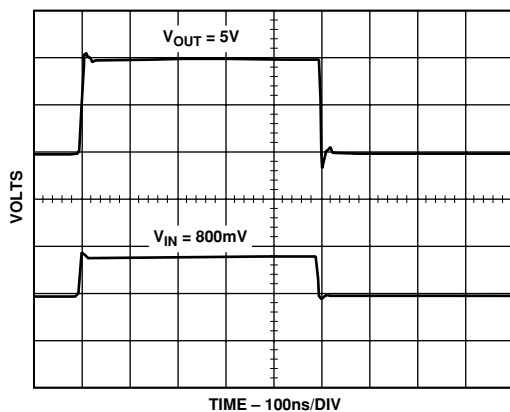

Figure 5. 4 V Step Response; $G = +5$, $V_S = \pm 6$ V, $R_L = 25$ Ω , Single-Ended

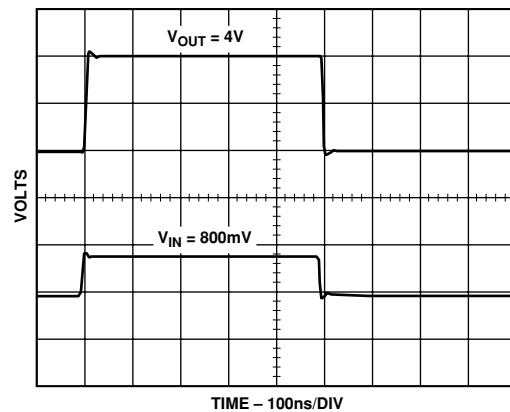

Figure 8. 4 V Step Response; $G = +5$, $V_S = \pm 12$ V, $R_L = 25$ Ω , Single-Ended

AD8016

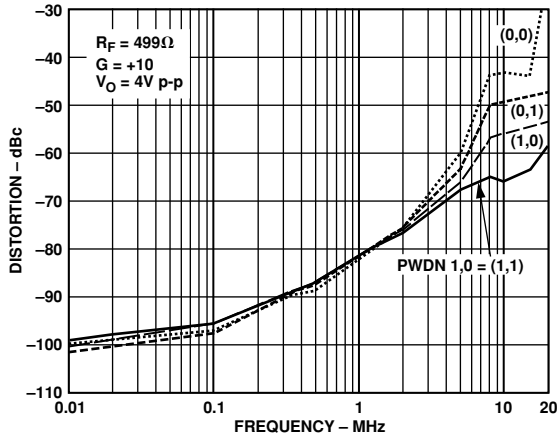

Figure 9. Distortion vs. Frequency; Second Harmonic, $V_S = \pm 12\text{ V}$, $R_L = 50\ \Omega$, Differential

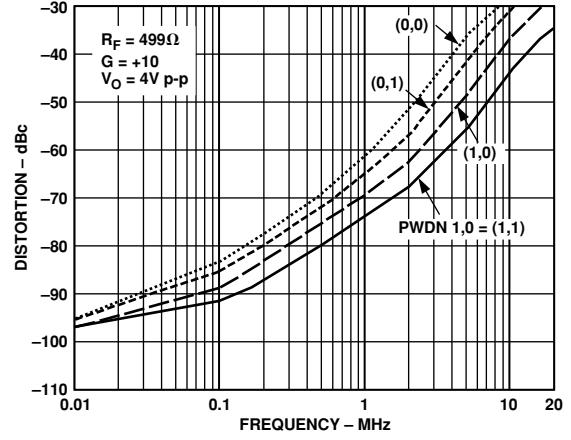

Figure 12. Distortion vs. Frequency; Third Harmonic, $V_S = \pm 12\text{ V}$, $R_L = 50\ \Omega$, Differential

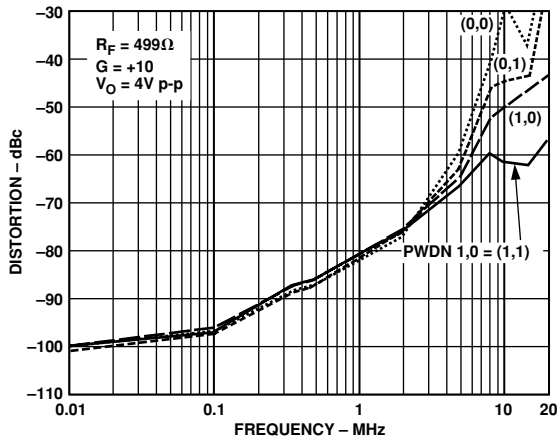

Figure 10. Distortion vs. Frequency; Second Harmonic, $V_S = \pm 6\text{ V}$, $R_L = 50\ \Omega$, Different

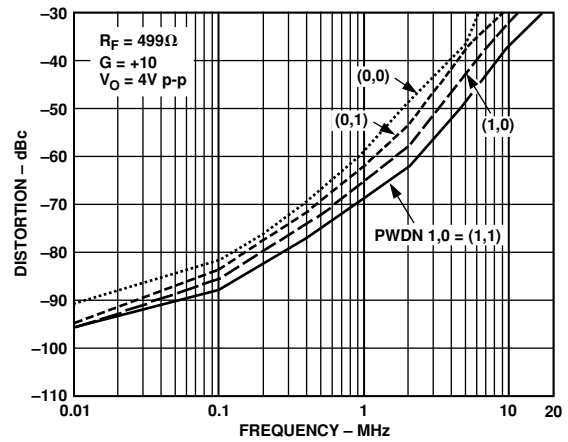

Figure 13. Distortion vs. Frequency; Third Harmonic, $V_S = \pm 6\text{ V}$, $R_L = 50\ \Omega$, Differential

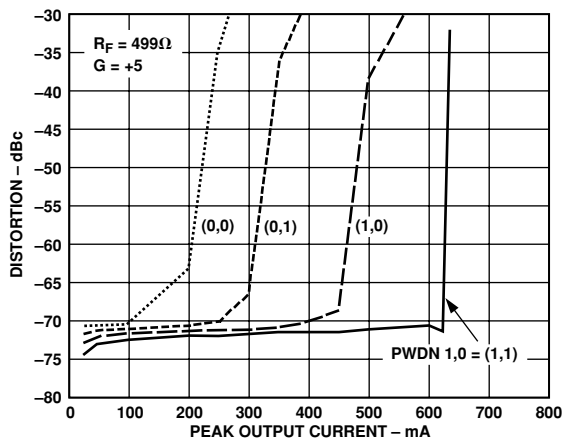

Figure 11. Distortion vs. Peak Output Current; Second Harmonic, $V_S = \pm 12\text{ V}$, $R_L = 10\ \Omega$, $f = 100\text{ kHz}$, Single-Ended

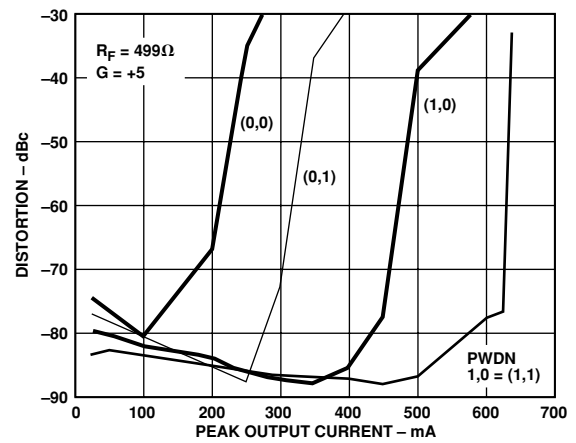

Figure 14. Distortion vs. Peak Output Current, Third Harmonic; $V_S = \pm 12\text{ V}$, $R_L = 10\ \Omega$, $G = +5$, $f = 100\text{ kHz}$, Single-Ended

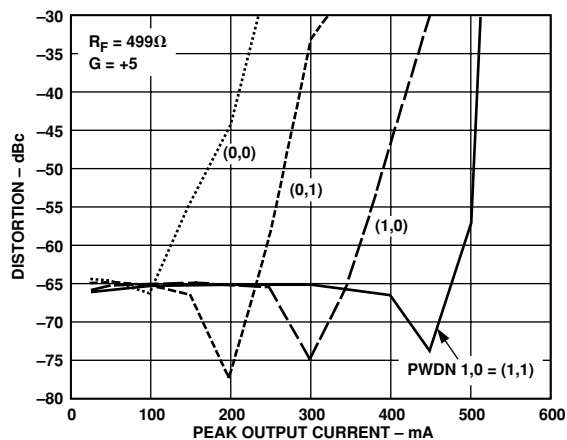

Figure 15. Distortion vs. Peak Output Current; Second Harmonic, $V_S = \pm 6\text{ V}$, $R_L = 5\ \Omega$, $f = 100\text{ kHz}$, Single-Ended

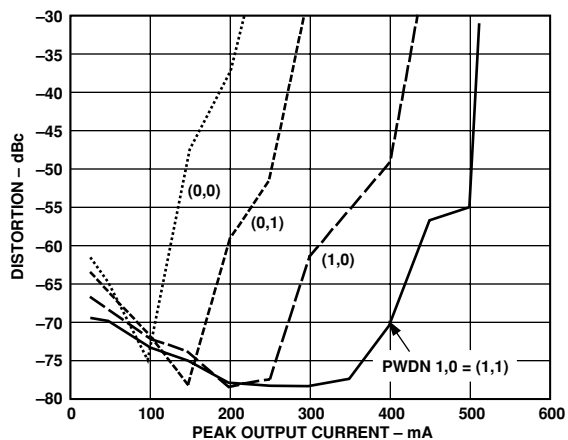

Figure 18. Distortion vs. Peak Output Current; Third Harmonic, $V_S = \pm 6\text{ V}$, $G = +5$, $R_L = 5\ \Omega$, $f = 100\text{ kHz}$, Single-Ended

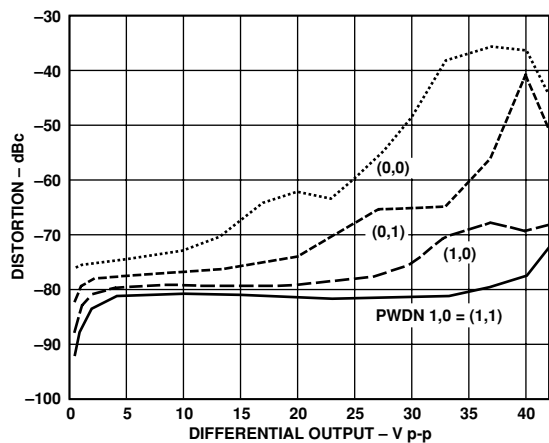

Figure 16. Distortion vs. Output Voltage; Second Harmonic, $V_S = \pm 12\text{ V}$, $G = +10$, $f = 1\text{ MHz}$, $R_L = 50\ \Omega$, Differential

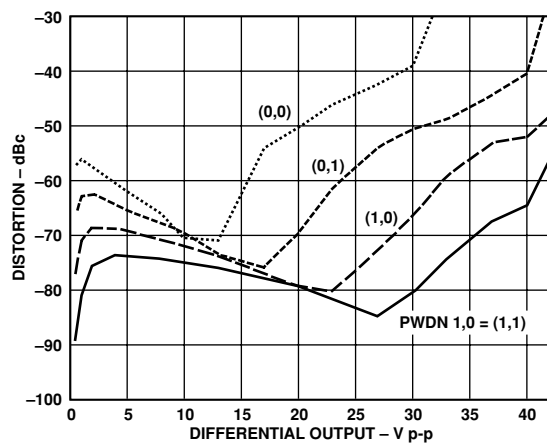

Figure 19. Distortion vs. Output Voltage; Third Harmonic, $V_S = \pm 12\text{ V}$, $G = +10$, $f = 1\text{ MHz}$, $R_L = 50\ \Omega$, Differential

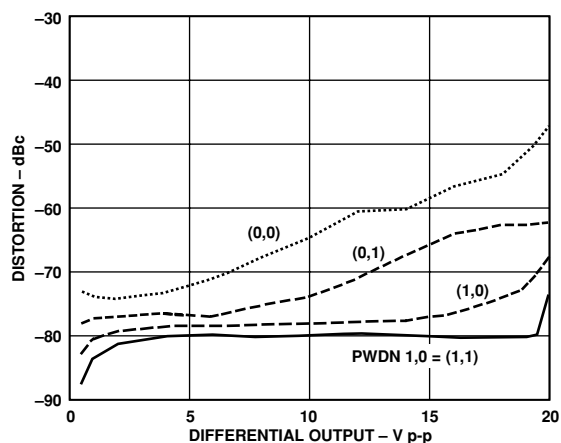

Figure 17. Distortion vs. Output Voltage; Second Harmonic, $V_S = \pm 6\text{ V}$, $G = +10$, $f = 1\text{ MHz}$, $R_L = 50\ \Omega$, Differential

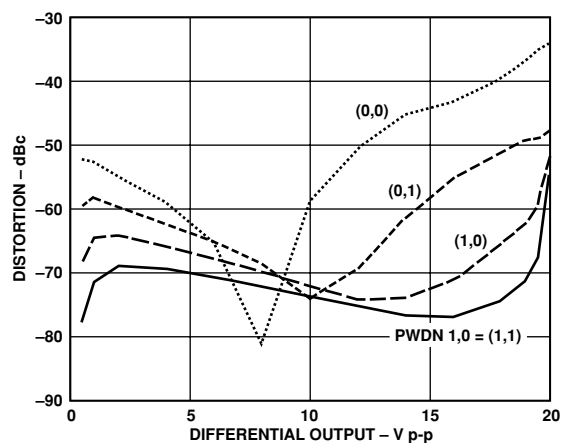

Figure 20. Distortion vs. Output Voltage, Third Harmonic, $V_S = \pm 6\text{ V}$, $G = +10$, $f = 1\text{ MHz}$, $R_L = 50\ \Omega$, Differential

AD8016

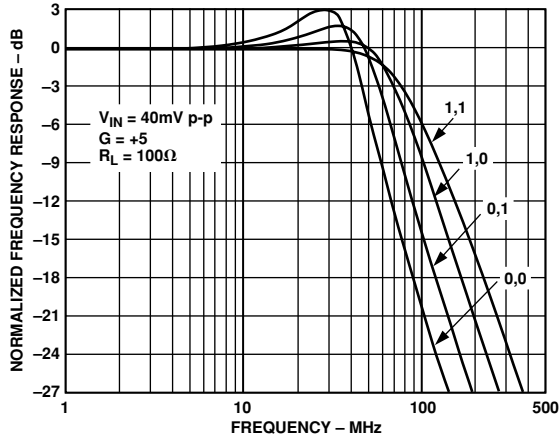

Figure 21. Frequency Response; $V_S = \pm 12\text{ V}$, @ PWDN1, PWDN0 Codes

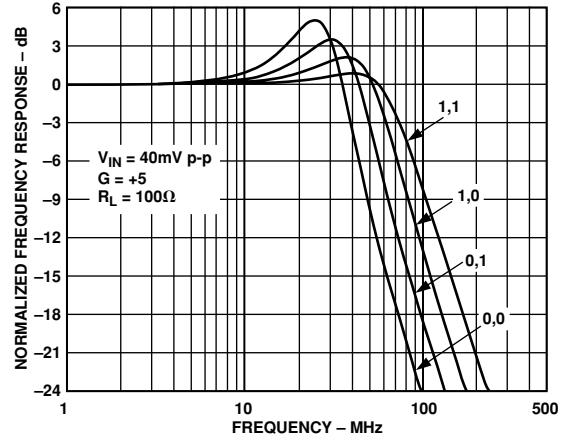

Figure 24. Frequency Response; $V_S = \pm 6\text{ V}$, @ PWDN1, PWDN0 Codes

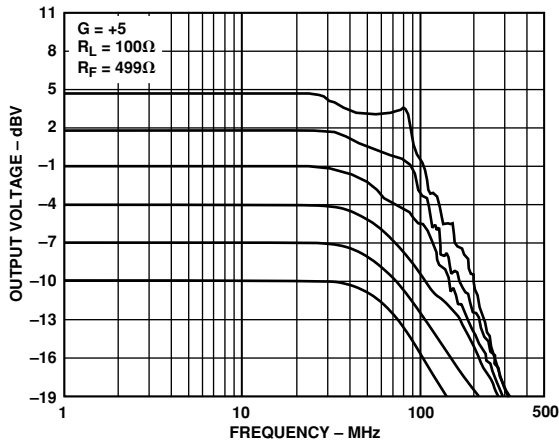

Figure 22. Output Voltage vs. Frequency; $V_S = \pm 12\text{ V}$

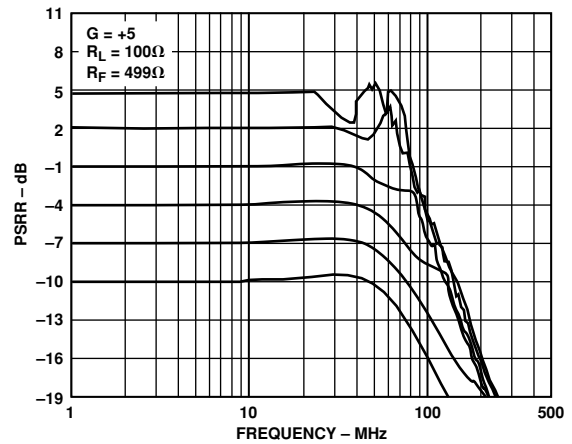

Figure 25. PSRR vs. Frequency; $V_S = \pm 6\text{ V}$

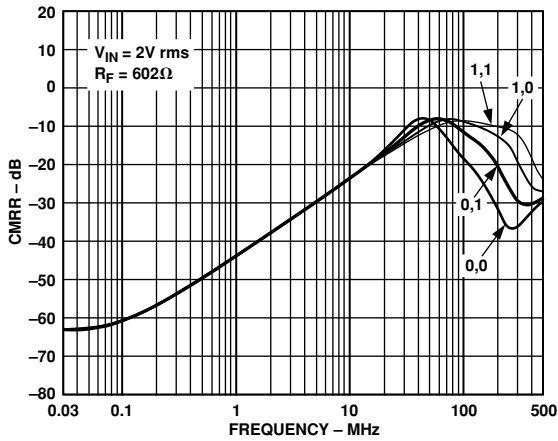

Figure 23. CMRR vs. Frequency; $V_S = \pm 12\text{ V}$ @ PWDN1, PWDN0 Codes

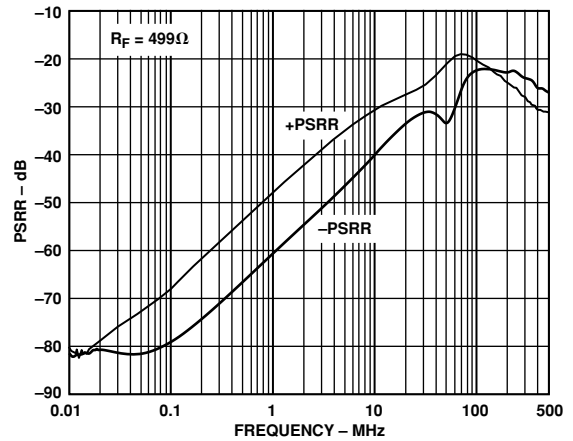

Figure 26. PSRR vs. Frequency; $V_S = \pm 12\text{ V}$

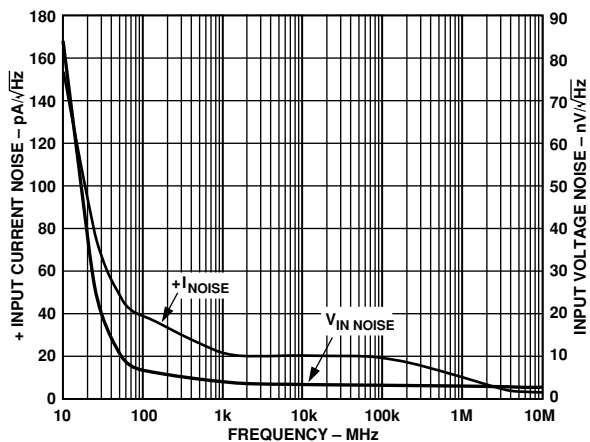

Figure 27. Noise vs. Frequency

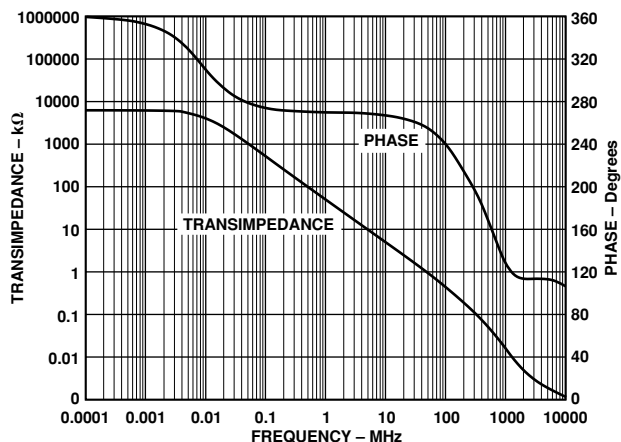

Figure 30. Open-Loop Transimpedance and Phase vs. Frequency

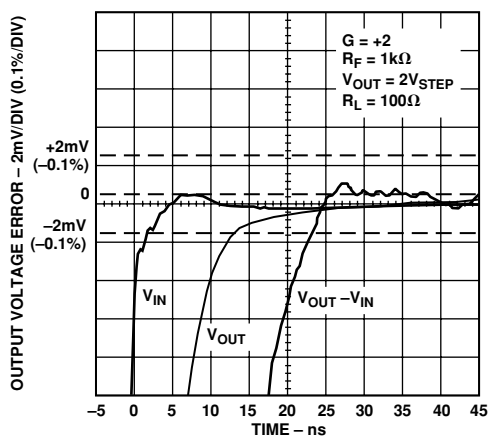

Figure 28. Settling Time 0.1%; $V_S = \pm 12 V$

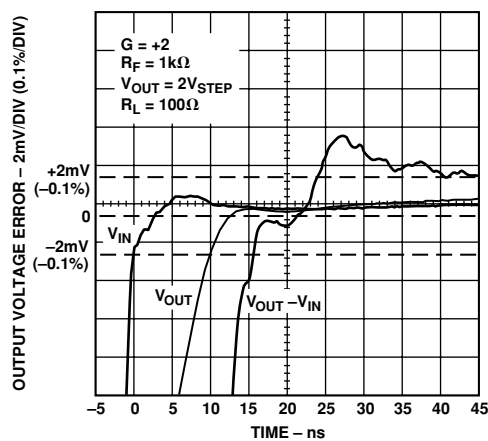

Figure 31. Settling Time 0.1%; $V_S = \pm 6 V$

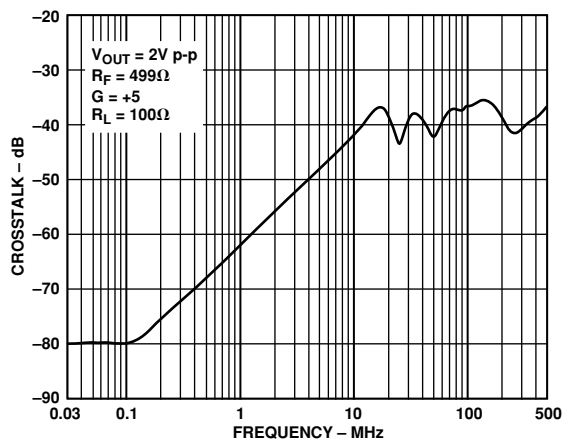

Figure 29. Output Crosstalk vs. Frequency

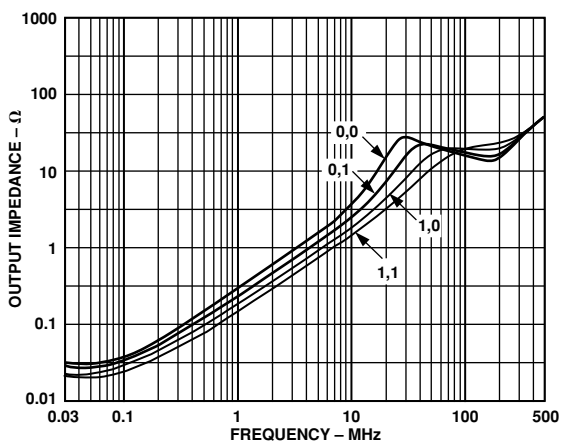
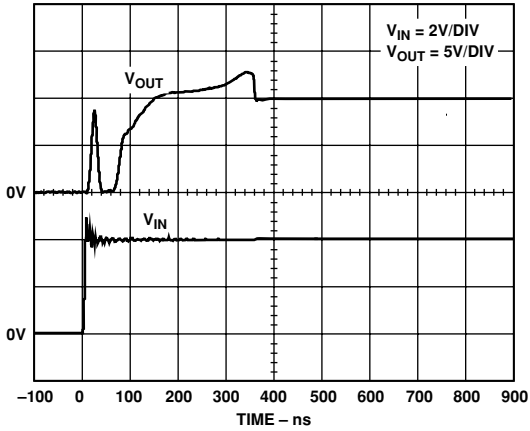
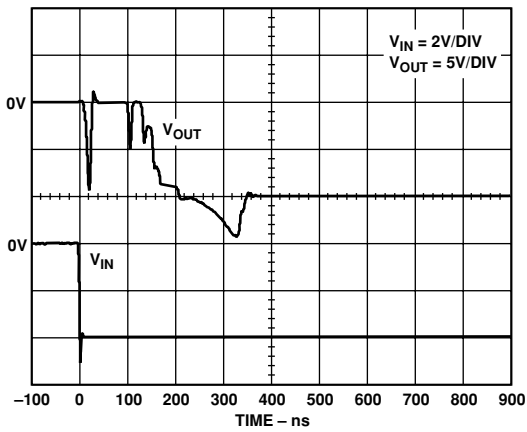

Figure 32. Output Impedance vs. Frequency @ PWDN1, PWDN0 Codes

AD8016



a. Overload Recovery; $V_S = \pm 12\text{ V}$, $G = +5$, $R_L = 100\ \Omega$



b. Overload Recovery; $V_S = \pm 12\text{ V}$, $G = +5$, $R_L = 100\ \Omega$
Figure 33.

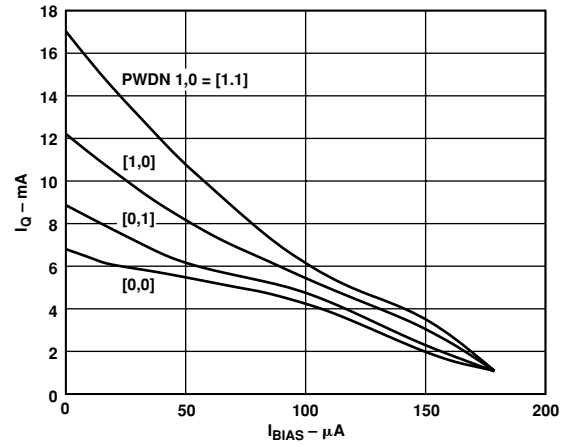

Figure 35. I_Q vs. I_{BIAS} Pin Current; $V_S = \pm 6\text{ V}$

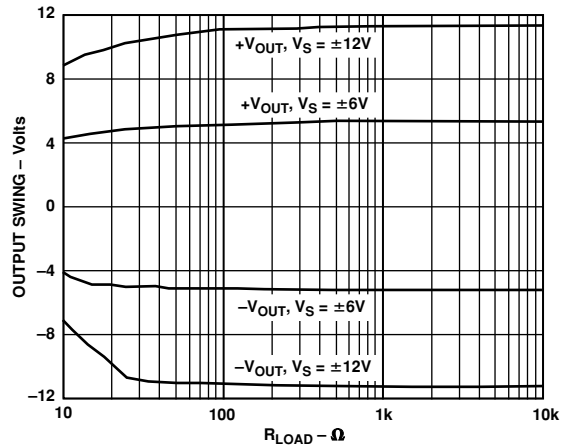

Figure 36. Output Voltage vs. R_{LOAD}

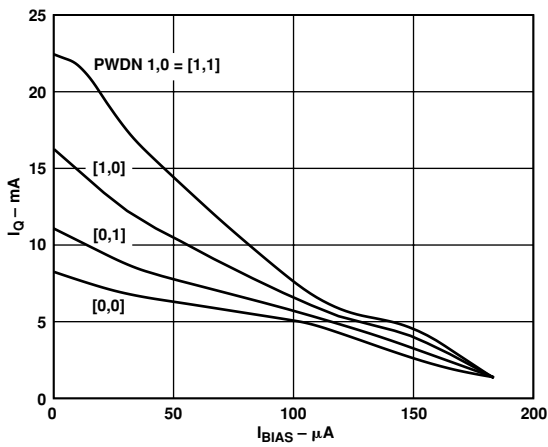

Figure 34. I_Q vs. I_{BIAS} Pin Current; $V_S = \pm 12\text{ V}$

THEORY OF OPERATION

The AD8016 is a current feedback amplifier with high (500 mA) output current capability. With a current feedback amplifier the current into the inverting input is the feedback signal and the open-loop behavior is that of a transimpedance, dV_o/dI_{in} or T_Z . The open-loop transimpedance is analogous to the open-loop voltage gain of a voltage feedback amplifier. Figure 37 shows a simplified model of a current feedback amplifier. Since R_{IN} is proportional to $1/g_m$, the equivalent voltage gain is just $T_Z \times g_m$, where g_m is the transconductance of the input stage. Basic analysis of the follower with gain circuit yields:

$$\frac{V_O}{V_{IN}} = G \times \frac{T_Z(S)}{T_Z(S) + G \times R_{IN} + R_F}$$

where:

$$G = 1 + \frac{R_F}{R_G}$$

$$R_{IN} = \frac{1}{g_m} \approx 25 \Omega$$

Recognizing that $G \times R_{IN} \ll R_F$ for low gains, the familiar result of constant bandwidth with gain for current feedback amplifiers is evident, the 3 dB point being set when $|T_Z| = R_F$. Of course, for a real amplifier there are additional poles that contribute excess phase and there will be a value for R_F below which the amplifier is unstable. Tolerance for peaking and desired flatness will determine the optimum R_F in each application.

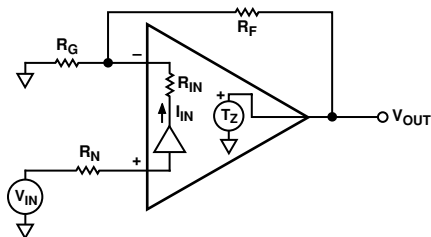

Figure 37. Simplified Block Diagram

The AD8016 is the first current feedback amplifier capable of delivering 400 mA of output current while swinging to within 2 V of either power supply rail. This enables full CO ADSL performance on only 12 V rails, an immediate 20% power saving. The AD8016 is also unique in that it has a power management system included on-chip. It features four user programmable power levels (all of which provide a low output impedance of the driver), as well as the provision for complete shutdown (high impedance state). Also featured is a thermal shutdown with alarm signal.

POWER SUPPLY AND DECOUPLING

The AD8016 should be powered with a good quality (i.e., low noise) dual supply of ± 12 V for the best distortion and Multitone Power Ratio (MTPR) performance. Careful attention must be paid to decoupling the power supply pins. A 10 μ F capacitor located in near proximity to the AD8016 is required to provide good decoupling for lower frequency signals. In addition, 0.1 μ F decoupling capacitors should be located as close to each of the four power supply pins as is physically possible. All ground pins should be connected to a common low impedance ground plane.

FEEDBACK RESISTOR SELECTION

In current feedback amplifiers, selection of feedback and gain resistors will have an impact on the MTPR performance, bandwidth and gain flatness. Care should be exercised in the selection of these resistors so that optimum performance is achieved. The table below shows the recommended resistor values for use in a variety of gain settings. These values are suggested as a good starting point when designing for any application.

Table I. Resistor Selection Guide

| Gain | R_F (Ω) | R_G (Ω) |
|------|--------------------|--------------------|
| +1 | 1 k | ∞ |
| -1 | 500 | 500 |
| +2 | 650 | 650 |
| +5 | 750 | 187 |
| +10 | 1 k | 111 |

BIAS PIN AND PWDN FEATURES

The AD8016 is designed to cover both CO (Central Office) and CPE (Customer Premise Equipment) ends of an xDSL application. It offers full versatility in setting quiescent bias levels for the particular application from full ON to reduced bias (in three steps) to full OFF (via BIAS pin). This versatility gives the modem designer the flexibility to maximize efficiency while maintaining reasonable levels of Multitone Power Ratio (MTPR) performance. Optimizing driver efficiency while delivering the required DMT power is accomplished with the AD8016 through the use of on-chip power management features. Two digitally programmable logic pins, PWDN1 and PWDN0, may be used to select four different bias levels; 100%, 60%, 40%, and 25% of full quiescent power (see Table II).

Table II. PWDN Code Selection Guide

| PWDN1 Code | PWDN0 Code | Quiescent Bias Level |
|------------|------------|--|
| 1 | 1 | 100% (Full ON) |
| 1 | 0 | 60% |
| 0 | 1 | 40% |
| 0 | 0 | 25% (Low Z_{OUT} but Not OFF) |
| X | X | Full OFF (High Z_{OUT} via 250 μ A Pulled Out of BIAS Pin) |

The bias level can be controlled with TTL logic levels (HI = 1) applied to PWDN1 and PWDN0 pins alone or in combination with BIAS control pin. The DGND or digital ground pin is the logic ground reference for PWDN1 and PWDN0 pins. In typical ADSL applications where ± 12 V or ± 6 V supplies (also single supplies) are used, the DGND pin is connected to analog ground.

The BIAS control pin by itself is a means to continuously adjust the AD8016 internal biasing and thus quiescent current I_Q . By pulling out a current of 0 μ A (or open) to approximately 200 μ A, the quiescent current can be adjusted from 100% (full ON) to a full OFF condition. The full OFF condition yields a high output impedance. Because of on-chip resistor variation of up to $\pm 20\%$ the actual amount of current required to fully shut down the AD8016 can vary. To institute a full chip shutdown, a pull-down current of 250 μ A is recommended. See Figure 38 for logic drive circuit for complete amplifier shutdown. Figures 34 and 35 show the relationship between current pulled out of

AD8016

BIAS pin (I_{BIAS}) and the supply current (I_Q). A typical shutdown I_Q is less than 1 mA total. Alternatively, an external pull-down resistor to ground or a current sink attached to the BIAS pin can be used to set I_Q to lower levels (see Figure 39). The BIAS pin may be used in combination with the PWDN1 and PWDN0 pins; however, diminished MTPR performance may result when I_Q is lowered too much. Current pulled away from the BIAS pin will shunt away a portion of the internal bias current. Setting PWDN1 or PWDN0 to Logic 0 also shunts away a portion of the internal bias current. The reduction of quiescent bias levels due to the use of PWDN1 and PWDN0 is consistent with the percentages established in Table II. When PWDN0 alone is set to Logic 0, and no other means of reducing the internal bias currents is used, full-rate ADSL signals may be driven while maintaining reasonable levels of MTPR.

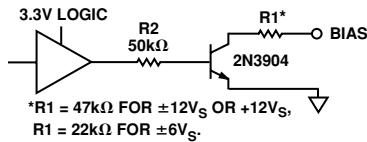

Figure 38. Logic Drive of BIAS Pin for Complete Amplifier Shutdown

THERMAL SHUTDOWN

The AD8016ARB and ARP have been designed to incorporate shutdown protection against accidental thermal overload. In the event of thermal overload, the AD8016 was designed to shut down at a junction temperature of 165°C and return to normal operation at a junction temperature 140°C. The AD8016 will continue to operate, cycling on and off, as long as the thermal overload condition remains. The frequency of the protection cycle depends on the ambient environment, severity of the thermal overload condition, the power being dissipated and the thermal mass of the PCB beneath the AD8016. When the AD8016 begins to cycle due to thermal stress, the internal shutdown circuitry draws current out of the node connected in common with the BIAS pin, while the voltage at the BIAS pin goes to the negative rail. When the junction temperature returns to 140°C, current is no longer drawn from this node and the BIAS pin voltage returns to the positive rail. Under these circumstances, the BIAS pin can be used to trip an alarm indicating the presence of a thermal overload condition.

Figure 39 also shows three circuits for converting this signal to a standard logic level.

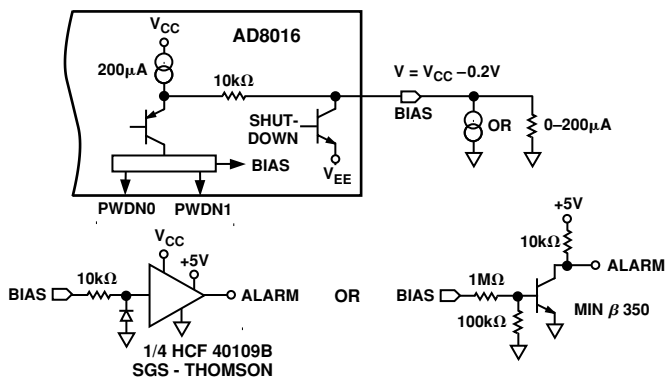

Figure 39. Shutdown and Alarm Circuit

APPLICATIONS

The AD8016ARP and AD8016ARB dual xDSL line driver amplifiers are the most efficient xDSL line drivers available to the market today. The AD8016 may be applied in driving modulated signals including Discrete Multitone (DMT) in either direction; upstream from Customer Premise Equipment (CPE) to the Central Office (CO) and downstream from CO to CPE. The most significant thermal management challenge lies in driving downstream information from CO sites to the CPE. Driving xDSL information downstream suggests the need to locate many xDSL modems in a single CO site. The implication is that several modems will be placed onto a single printed circuit board residing in a card cage located in a variety of ambient conditions. Environmental conditioners such as fans or air conditioning may or may not be available, depending on the density of modems and the facilities contained at the CO site. To achieve long-term reliability and consistent modem performance, designers of CO solutions must consider the wide array of ambient conditions that exist within various CO sites.

MULTITONE POWER RATIO OR MTPR

ADSL systems rely on Discrete Multitone (or DMT) modulation to carry digital data over phone lines. DMT modulation appears in the frequency domain as power contained in several individual frequency subbands, sometimes referred to as tones or bins, each of which is uniformly separated in frequency. (See Figure 1 for example of downstream DMT signals used in evaluating MTPR performance.) A uniquely encoded, Quadrature Amplitude Modulation (QAM) signal occurs at the center frequency of each subband or tone. Difficulties will exist when decoding these subbands if a QAM signal from one subband is corrupted by the QAM signal(s) from other subbands, regardless of whether the corruption comes from an adjacent subband or harmonics of other subbands. Conventional methods of expressing the output signal integrity of line drivers, such as spurious free dynamic range (SFDR), single-tone harmonic distortion or THD, two-tone Intermodulation Distortion (IMD) and 3rd order intercept (IP3) become significantly less meaningful when amplifiers are required to drive DMT and other heavily modulated waveforms. A typical xDSL downstream DMT signal may contain as many as 256 carriers (subbands or tones) of QAM signals. Multitone Power Ratio (MTPR) is the relative difference between the measured power in a typical subband (at one tone or carrier) versus the power at another subband specifically selected to contain no QAM data. In other words, a selected subband (or tone) remains open or void of intentional power (without a QAM signal) yielding an empty frequency bin. MTPR, sometimes referred to as the “empty bin test,” is typically expressed in dBc, similar to expressing the relative difference between single-tone fundamentals and 2nd or 3rd harmonic distortion components.

See Figure 1 for a sample of the ADSL downstream spectrum showing MTPR results while driving 20.4 dBm of power onto a 100 Ω line. Measurements of MTPR are typically made at the output (line side) of ADSL hybrid circuits. (See Figure 46a for an example of Analog Devices’ hybrid schematic.) MTPR can be affected by the components contained in the hybrid circuit, including the quality of the capacitor dielectrics, voltage ratings and the turns ratio of the selected transformers. Other components aside, an ADSL driver hybrid containing the AD8016 can be optimized for the best MTPR performance by selecting the turns ratio of the transformers. The voltage and current demands from the differential driver changes, depending on the transformer

turns ratio. The point on the curve indicating maximum dynamic headroom is achieved when the differential driver delivers both the maximum voltage and current while maintaining the lowest possible distortion. Below this point the driver has reserve current-driving capability and experiences voltage clipping while above this point the amplifier runs out of current drive capability before the maximum voltage drive capability is reached. Since a transformer reflects the secondary load impedance back to the primary side by the square of the turns ratio, varying the turns ratio changes the load across the differential driver. In the transformer configuration of Figure 46a and 46b, the turns ratio of the selected transformer is effectively doubled due to the parallel wiring of the transformer primaries within this ADSL driver hybrid. The following equation may be used to calculate the load impedance across the output of the differential driver, reflected by the transformers, from the line side of the xDSL driver hybrid. Z' is the primary side impedance as seen by the differential driver; Z_2 is the line impedance and N is the transformer turns ratio.

$$Z' \equiv \frac{Z_2}{(2 \times N)^2}$$

Figure 40 shows the dynamic headroom in each subband of a downstream DMT waveform versus turns ratio running at 100% and 60% of the quiescent power while maintaining -65 dBc of MTPR at $V_S = \pm 12$ V.

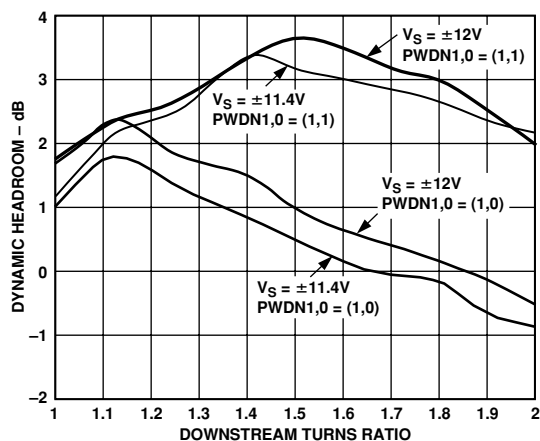

Figure 40. Dynamic Headroom vs. XFMR Turns Ratio, $V_S = \pm 12$ V

Once an optimum turns ratio is determined, the amplifier will have an MTPR performance for each setting of the power-down pins. The table below demonstrates the effects of reducing the total power dissipated by using the PWDN pins on MTPR performance when driving 20.4 dBm downstream onto the line with a transformer turns ratio of 1:1.4.

Table III. Dynamic Power Dissipation for Downstream Transmission

| PWDN1 | PWDN0 | PD (W) | MTPR |
|-------|-------|--------|-------------|
| 1 | 1 | 1.454 | -78 dBc |
| 1 | 0 | 1.262 | -75.3 dBc |
| 0 | 1 | 1.142 | -57.2 dBc |
| 0* | 0 | 0.120 | N/A |

*This mode is quiescent power dissipation.

GENERATING DMT

At this time, DMT-modulated waveforms are not typically menu-selectable items contained within arbitrary waveform generators. Even using (AWG) software to generate DMT signals, AWGs that are available today may not deliver DMT signals sufficient in performance with regard to MTPR due to limitations in the D/A converters and output drivers used by AWG manufacturers. Similar to evaluating single-tone distortion performance of an amplifier, MTPR evaluation requires a DMT signal generator capable of delivering MTPR performance better than that of the driver under evaluation. Generating DMT signals can be accomplished using a Tektronics AWG 2021 equipped with opt 4, (12/24-Bit, TTL Digital Data Out), digitally coupled to Analog Devices AD9754, a 14-bit TxDAC, buffered by an AD8002 amplifier configured as a differential driver. See Figure 45 for schematics of a circuit used to generate DMT signals that can achieve down to -80 dBc of MTPR performance, sufficient for use in evaluating xDSL drivers. Note that the DMT waveforms available with the AD8016ARP-EVAL and AD8016ARB-EVAL boards or similar WFM files are needed to produce the necessary digital data required to drive the TxDAC from the optional TTL Digital Data output of the TEK AWG2021. Copies of these WFM files can be obtained through the Analog Devices website. <http://www.analog.com/>.

EVALUATION BOARDS

The AD8016ARP-EVAL, AD8016ARB-EVAL, AD8016ARE-EVAL boards available through Analog Device provide a platform for evaluating the AD8016 in an ADSL differential line driver circuit. The board is laid out to accommodate Analog Devices two transformer line driver hybrid circuit (see Figures 46a and 46b) including line matching network, an RJ11 jack for interfacing to line simulators, transformer coupled input for single-to-differential input conversion and accommodations for the receiver function. Schematics and layout information are available for both versions of the EVAL board. Also included in the package are WFM files for use in generating 14-bit DMT waveforms. Upstream data is contained in the ...24.wfm files and downstream data in the ...128.wfm files.

These DMT modulated signals are used to evaluate xDSL products for Multitone Power Ratio or MTPR performance. The data files are used in pairs (adslu24.wfm and adsl124.wfm go together, etc.) and are loaded into Tektronics AWG2021 arbitrary waveform generator. The adslu24.wfm is loaded via the TEK AWG2021 floppy drive into Channel 1, while the adsl124.wfm is simultaneously loaded into Channel 2. The number in the file name, prefixed with "u," goes into CH1 or upper channel and the "l" goes into CH2 or the lower channel. 12 bits from CH1 are combined with 2 bits from CH2 to achieve 14-bit digital data at the digital outputs of the TEK 2021. The resulting waveforms produced at the AD9754-EB outputs are then buffered and amplified by the AD8002 differential driver to achieve 14-bit performance from this DMT signal source.

POWER DISSIPATION

In order to properly size the heat sinking area for your application, it is important to consider the total power dissipation of the AD8016. The dc power dissipation for $V_{IN} = 0$ is $I_Q (V_{CC} - V_{EE})$, or $2 \times I_Q \times V_S$.

For the AD8016 powered on $+12$ V and -12 V supplies ($\pm V_S$), the number is 0.6 W. In a differential driver circuit (Figure 6),

AD8016

we can use symmetry to simplify the computation for a dc input signal.

$$P_D = 2 \times I_Q \times V_S + 4 \times (V_S - V_O) \frac{V_O}{R_L}$$

where

V_O is the peak output voltage of an amplifier.

This formula is slightly pessimistic due to the fact that some of the quiescent supply current is commutated during sourcing or sinking current into the load. For a sine wave source, integration over a half cycle yields:

$$P_D = 2 \times I_Q \times V_S + 2 \left(\frac{4 V_O V_S}{\pi R_L} - \frac{V_O^2}{R_L} \right)$$

The situation is more complicated with a complex modulated signal. In the case of a DMT signal, taking the equivalent sine wave power overestimates the power dissipation by ~23%. For example:

$$\begin{aligned} P_{OUT} &= 23.4 \text{ dBm} = 220 \text{ mW} \\ V_{OUT} @ 50 \Omega &= 3.31 \text{ V rms} \\ V_O &= 2.354 \text{ V} \end{aligned}$$

at each amplifier output, which yields a P_D of 1.81 W.

Through measurement, a DMT signal of 23.4 dBm requires 1.47 W of power to be dissipated by the AD8016. Figure 41 shows the results of calculation and actual measurements detailing the relationship between the power dissipated by the AD8016 versus the total output power delivered to the back termination resistors and the load combined. A 1:2 transformer turns ratio was used in the calculations and measurements.

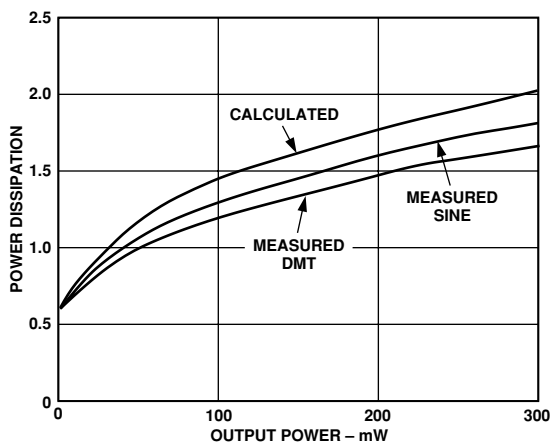

Figure 41. Power Dissipation vs. Output Power (Including Back Terminations). See Figure 7 for Test Circuit

THERMAL ENHANCEMENTS AND PCB LAYOUT

There are several ways to enhance the thermal capacity of the CO solution. Additional thermal capacity can be created using enhanced PCB layout techniques such as interlacing (sometimes referred to as stitching or interconnection) of the layers immediately beneath the line driver. This technique serves to increase the thermal mass or capacity of the PCB immediately beneath the driver. (See AD8016-EVAL boards for an example of this method of thermal enhancement.) A cooling fan that draws moving air over the PCB and xDSL drivers, while not always required, may be useful in reducing the operating temperature

of the die, allowing more drivers/square-inch within the CO design. The AD8016, whether in a PSOP3 (ARP) or batwing (ARB) package, can be designed to operate in the CO solution using prudent measures to manage the power dissipation through careful PCB design. The PSOP3 package is available for use in designing the highest density CO solutions. Maximum heat transfer to the PCB can be accomplished using the PSOP3 package when the thermal slug is soldered to an exposed copper pad directly beneath the AD8016. Optimum thermal performance can be achieved in the ARE package only when the back of the package is soldered to a PCB designed for maximum thermal capacity (see Figure 44). Thermal experiments with the PSOP3 package were conducted *without* soldering the heat slug to the PCB. Heat transfer was through physical contact only. The following offers some insight into the AD8016 power dissipation and relative junction temperature, the effects of PCB size and composition on the junction-to-air thermal resistance or θ_{JA} .

THERMAL TESTING

A wind tunnel study was conducted to determine the relationship between thermal capacity (i.e., printed circuit board copper area), air flow and junction temperature. Junction-to-ambient thermal resistance, θ_{JA} , was also calculated for the AD8016ARP, AD8016ARE, and AD8016ARB packages. The AD8016 was operated in a noninverting differential driver configuration, typical of an xDSL application yet isolated from any other modem components. Testing was conducted using a 1 ounce copper board in an ambient temperature of ~24°C over air flows of 200, 150, 100, and 50 (0.200 and 400 for AD8016ARE) linear feet per minute (LFM) and for ARP and ARB packages as well as in still air. The four-layer PCB was designed to maximize the area of copper on the outer two layers of the board while the inner layers were used to configure the AD8016 in a differential driver circuit. The PCB measured 3 × 4 inches in the beginning of the study and was progressively reduced in size to approximately 2 × 2 inches. The testing was performed in a wind tunnel to control air flow in units of LFM. The tunnel is approximately 11 inches in diameter.

AIR FLOW TEST CONDITIONS

DUT Power: Typical DSL DMT signal produces about 1.5 W of power dissipation in the AD8016 package. The fully biased (PWDN0 and PWDN1 = Logic 1) quiescent current of the AD8016 is ~25 mA. A 1 MHz differential sine wave at an amplitude of 8 V p-p/amplifier into an R_{LOAD} of 100 Ω differential (50 Ω per side) will produce the 1.5 W of power typical in the AD8016 device. (See the Power Dissipation section for details.)

Thermal Resistance: The junction-to-case thermal resistance (θ_{JC}) of the AD8016ARB or batwing package is 8.6°C/W, AD8016ARE is 5.6°C/W, and the AD8016ARP or PSOP3 package is 0.86°C/W. These package specifications were used in this study to determine junction temperature based on the measured case temperature.

PCB Dimensions of a Differential Driver Circuit: Several components are required to support the AD8016 in a differential driver circuit. The PCB area necessary for these components (i.e., feedback and gain resistors, ac coupling and decoupling capacitors, termination and load resistors) dictated the area of the smallest PCB in this study, 4.7 square inches. Further reduction in PCB area, although possible, will have consequences in terms of the maximum operating junction temperature.

EXPERIMENTAL RESULTS

The experimental data suggests that for both packages, and a PCB as small as 4.7 square inches, reasonable junction temperatures can be maintained even in the absence of air flow. The graph in Figure 42 shows junction temperature versus air flow for various dimensions of 1 ounce copper PCBs at an ambient temperature of 24°C in both the ARB and ARP packages. For the worst case package, the AD8016ARB and the worst case PCB at 4.7 square inches, the extrapolated junction temperature for an ambient environment of 85°C would be approximately 132°C with 0 LFM of air flow. If the target maximum junction temperature of the AD8016ARB is 125°C, a 4-layer PCB with 1 oz. copper covering the outer layers and measuring 9 square inches is required with 0 LFM of air flow.

Note that the AD8016ARE is targeted at xDSL applications other than full-rate CO ADSL. The AD8016ARE is targeted at g.lite and other xDSL applications where reduced power dissipation can be achieved through a reduction in output power. Extreme temperatures associated with full-rate ADSL using the AD8016ARE should be avoided whenever possible.

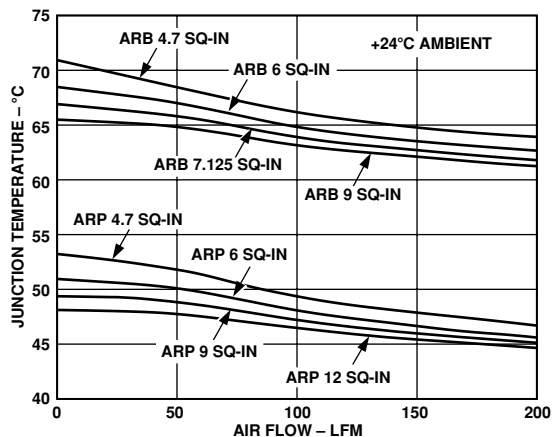

Figure 42. Junction Temperature vs. Air Flow

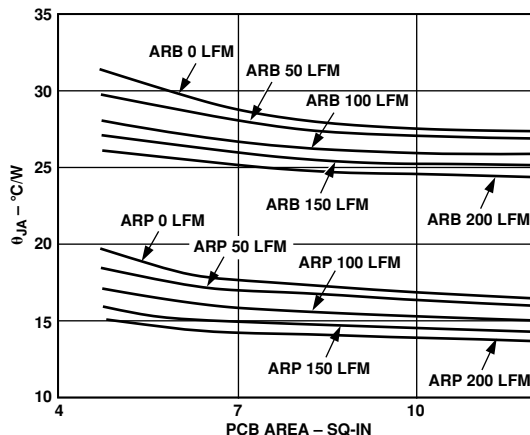

Figure 43. Junction-to-Ambient Thermal Resistance vs. PCB Area

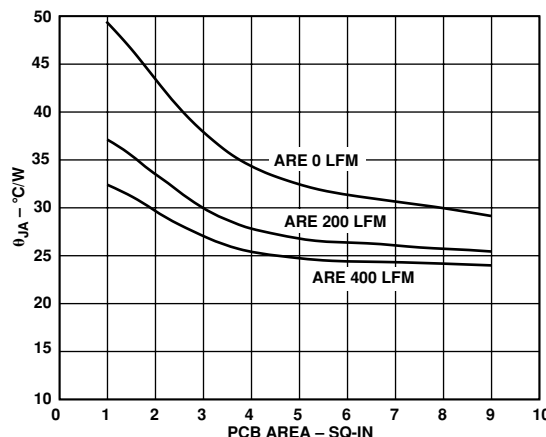

Figure 44. Junction-to-Ambient Thermal Resistance vs. PCB Area

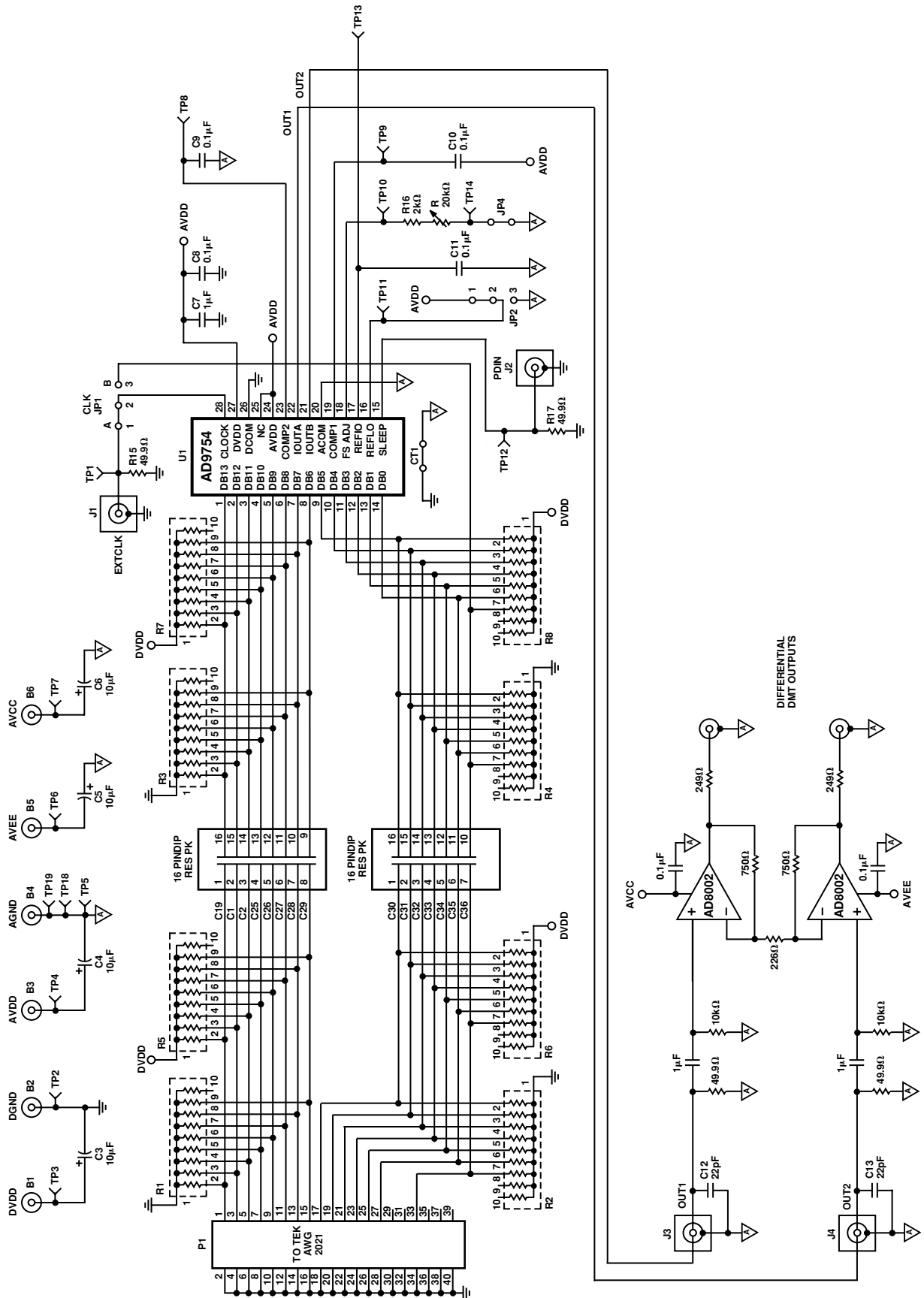

Figure 45. DMT Signal Generator Schematic

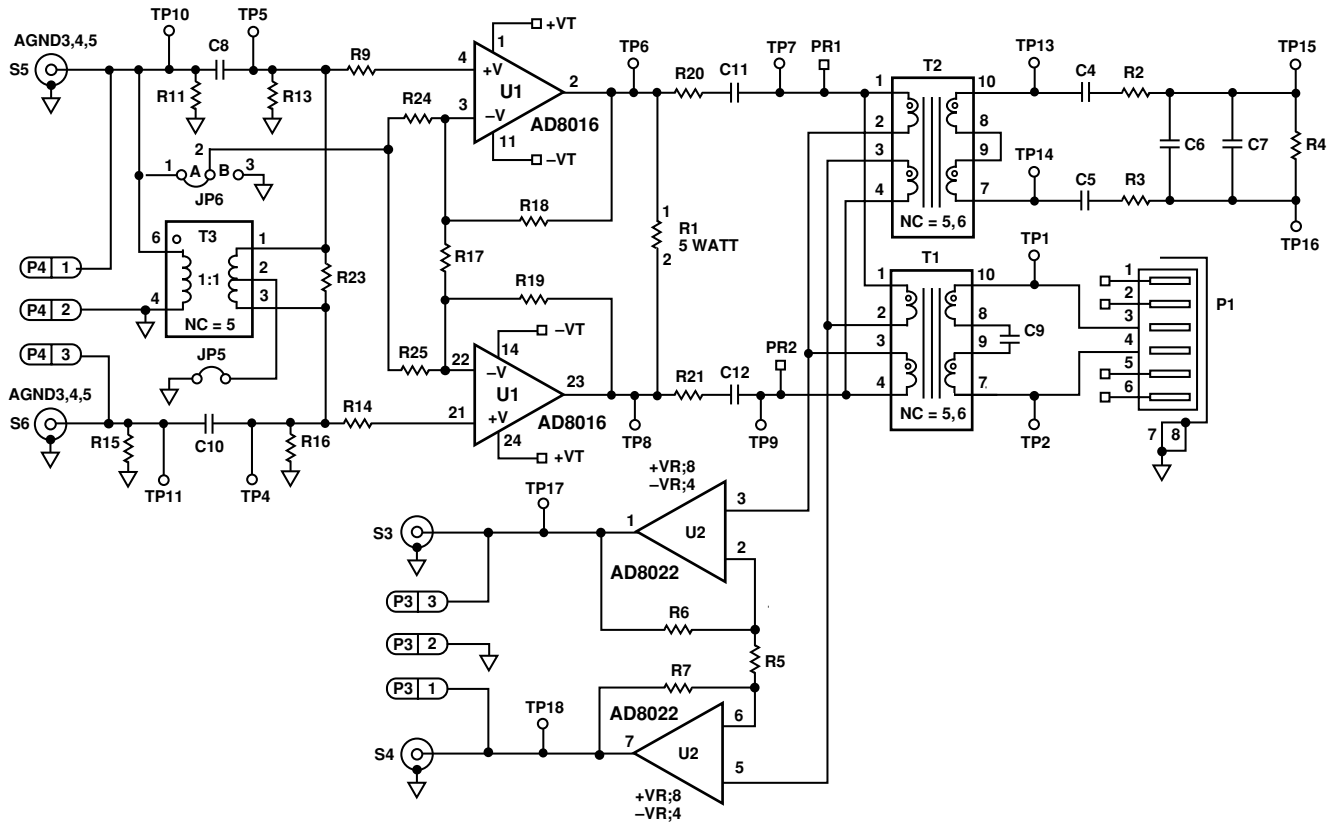

Figure 46a. Schematic AD8016ARB-EVAL

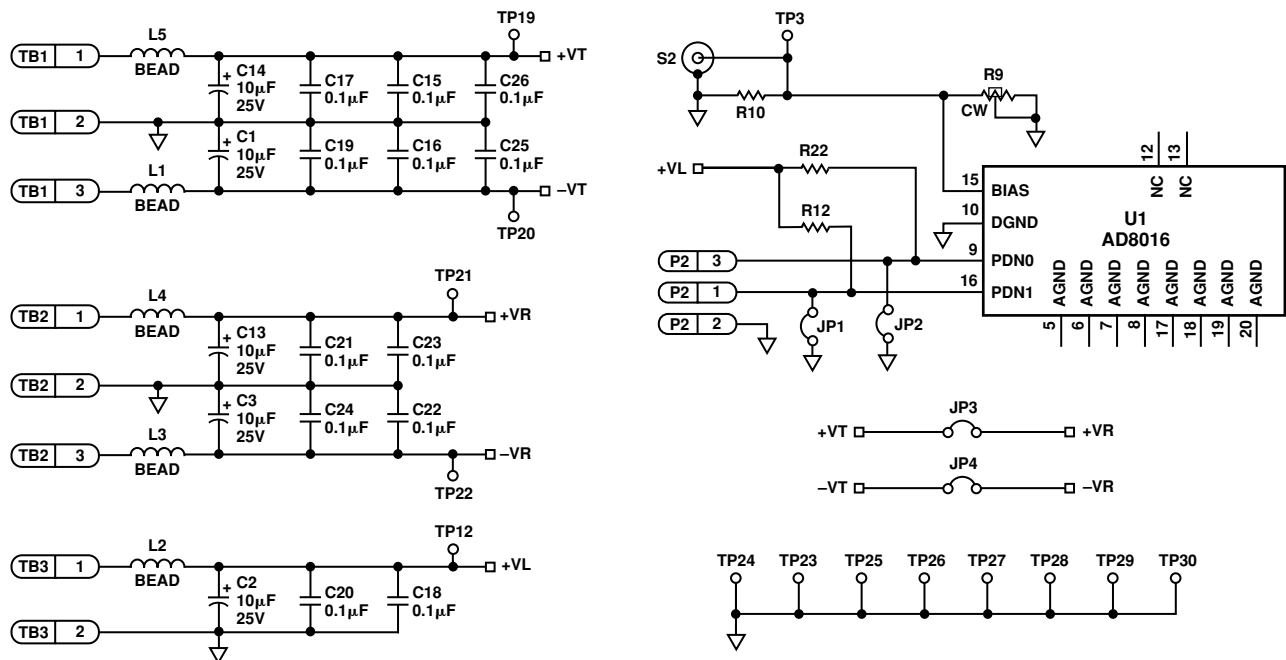

Figure 46b. Schematic AD8016ARB-EVAL

AD8016

LAYOUT AD8016ARB-EVAL

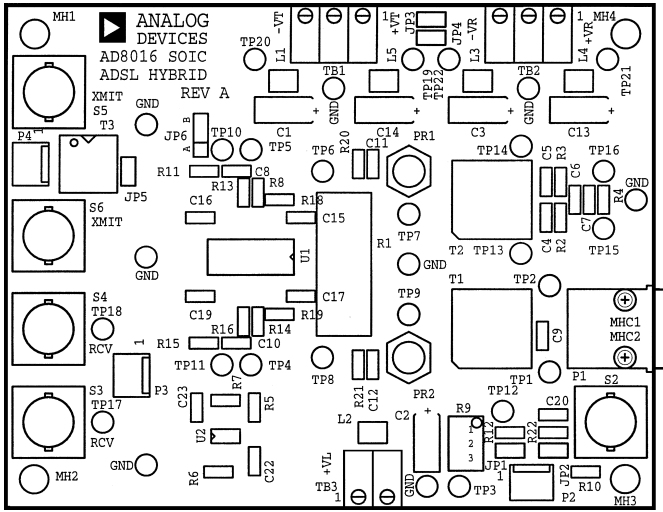

Figure 47. Assembly

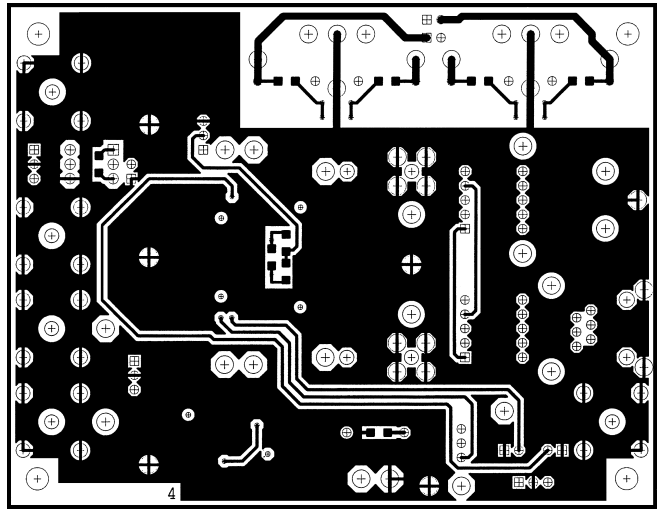

Figure 50. Layer 1

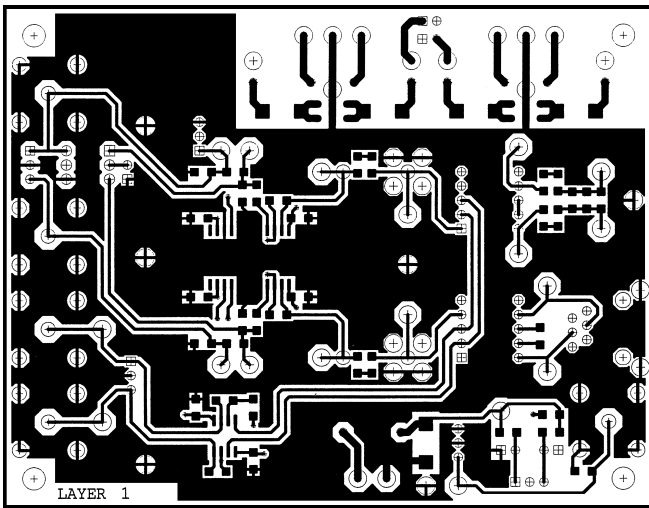

Figure 48. Layer 1

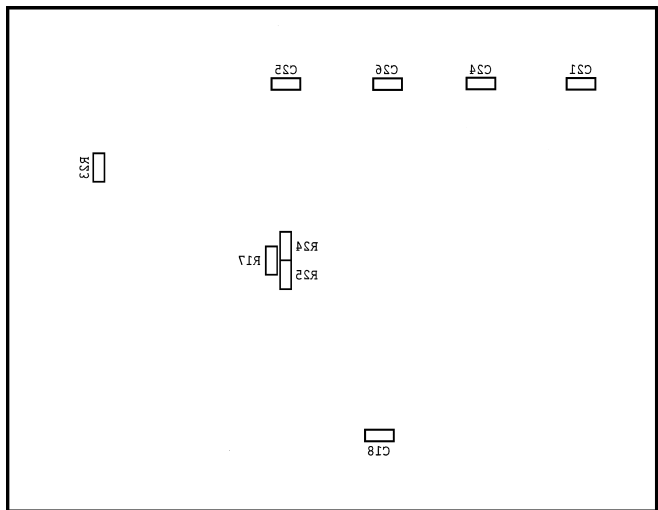

Figure 51. Silkscreen Bottom

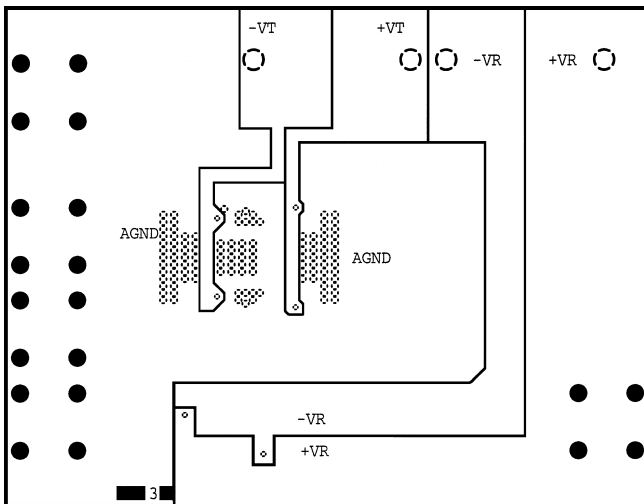

Figure 49. Power/Ground Plane

ALP – EVALUATION BOARD – BILL OF MATERIALS

| Qty. | Description | Vendor | Ref Desc. |
|---------------|---|----------------------|----------------|
| 5 | 10 μ F 25 V Size Tantalum Chip Capacitor | ADS# 4-7-2 | C1-3, 13, 14 |
| 10 | 0.1 μ F 50 V 1206 Size Ceramic Chip Capacitor | ADS# 4-5-18 | C15-21, 24-26 |
| 2 | 49.9 Ω 1% 1/8 W 1206 Size Chip Resistor | ADS# 3-14-26 | R11, 15 |
| 2 | 100 Ω 1% 1/8 W 1206 Size Chip Resistor | ADS# 3-18-40 | R8, 14 |
| 1 | 100 Ω 5% 3.0 W Metal Film Power Resistor | ADS# 3-24-1 | R1 |
| 3 | 1.00 k Ω 1% 1/6 W 1206 Size Chip Resistor | ADS# 3-18-11 | R17-R19 |
| 2 | 10.0 k Ω 1% 1/6 W 1206 Size Chip Resistor | ADS# 3-18-119 | R13 and 16 |
| 1 | Test Point (Black) [GND] | ADS# 12-18-44 | GND |
| 2 | Test Point (Brown) | ADS# 12-18-59 | TP10, 11 |
| 4 | Test Point (Red) | ADS# 12-18-43 | TP17-19, 21 |
| 2 | Test Point (Orange) | ADS# 12-18-60 | TP3, 15, 16 |
| 1 | Test Point (Yellow) | ADS# 12-18-32 | TP12 |
| 2 | Test Point (Green) | ADS# 12-18-61 | TP7, 9 |
| 2 | Test Point (Blue) | ADS# 12-18-62 | TP20, 22 |
| 2 | Test Point (Violet) | ADS# 12-18-63 | TP4, 5 |
| 4 | Test Point (Grey) | ADS# 12-18-64 | TP1, 2, 13, 14 |
| 2 | Test Point (White) | ADS# 12-18-42 | TP6, 8 |
| 2 | 3 Green Terminal Block. ONSHORE# EDZ250/3 | ADS# 12-19-14 | TB1, TB2 |
| 1 | 2 Green Terminal Block. ONSHORE# EDZ250/2 | ADS# 12-19-13 | TB3 |
| 5 | 1 Inch Center Shunt Berg# 65474-001 | ADS# 11-2-38 | J1-J5 |
| 5 | Male Header. 1 Inch Center. Berg #69157-102 | ADS# 11-2-37 | J1-J5 |
| 5 | Conn. BNC Vert. MT Telegartner # J01001A1944 | ADS# 12-6-22 | S2-S6 |
| 1 | AMP# 555154-1 MOD. JACK (SHIELDED) 6 6 | D-K# A 9024 | P1 |
| 1 | 3-Pin Gold Male Header Waldom #WM 2723-ND | D-K# WM 2723-ND | JP6 |
| 3 | 3-Pin Gold Male Locking Header Waldom #WM 2701-ND | D-K# WM 2701-ND | P2-4 |
| 1 | AD8016 ARB | ADS# AD 8016 XRP | D.U.T. |
| 1 | AD8016 SOIC Rev. A Evaluation PC Board | SIERRA/PROTO EXPRESS | Eval. PC Board |
| 4 | # 4 -40 \times 1/4" Panhead SS Machine Screw | ADS# 30-1-1 | |
| 4 | # 4 -40 \times 1/2" Threaded Alum. Standoffs | ADS# 30-16-2 | |
| OPTION | | | |
| 2 | 1:1.4 Turns Ratio RF Transformer from CoEv | C1374 Rev. 2 | T1, T2 |

OUTLINE DIMENSIONS

Dimensions shown in inches and (mm).

**20-Lead PSOP3
(RP-20A)**

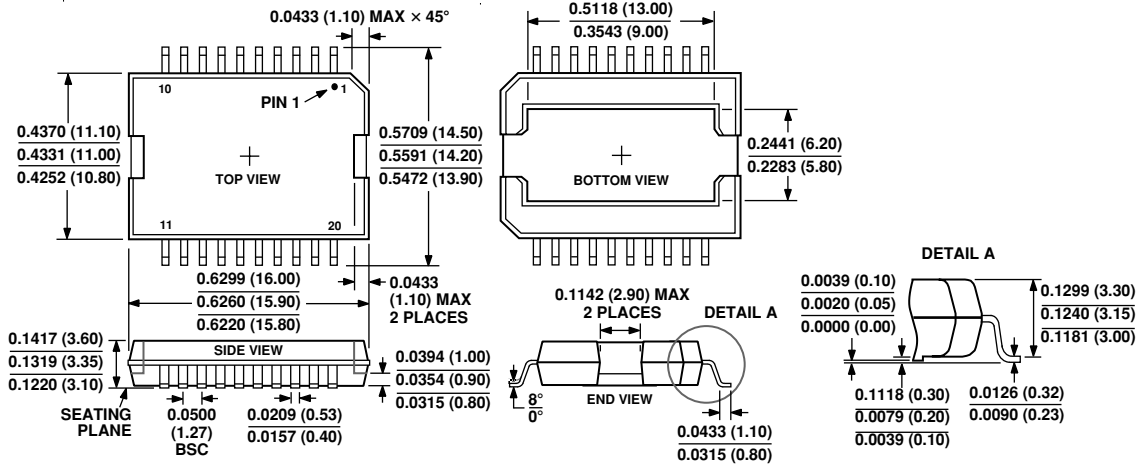

**24-Lead Batwing
(RB-24)**

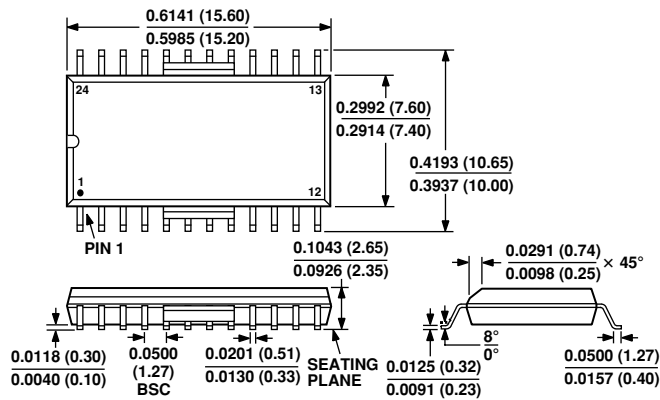

**28-Lead HTSSOP
(RE-28)**

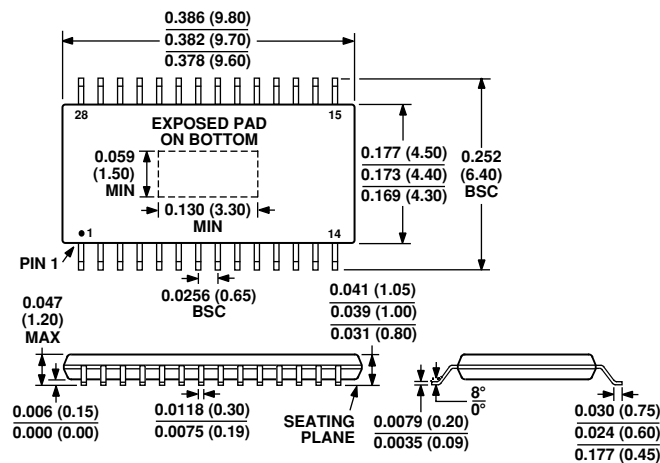

CONTROLLING DIMENSIONS ARE IN MILLIMETERS (mm)