

### FEATURES

**Single Supply Operation: 3 V to 30 V**  
**Very Low Input Bias Current: 2 pA**  
**Wide Input Voltage Range**  
**Rail-to-Rail Output Swing**  
**Low Supply Current: 500  $\mu$ A/Amp**  
**Wide Bandwidth: 2 MHz**  
**Slew Rate: 2 V/ $\mu$ s**  
**No Phase Reversal**

### APPLICATIONS

**Photo Diode Preamplifier**  
**Battery Powered Instrumentation**  
**Power Supply Control and Protection**  
**Medical Instrumentation**  
**Remote Sensors**  
**Low Voltage Strain Gage Amplifiers**  
**DAC Output Amplifier**

### GENERAL DESCRIPTION

The AD824 is a quad, FET input, single supply amplifier, featuring rail-to-rail outputs. The combination of FET inputs and rail-to-rail outputs makes the AD824 useful in a wide variety of low voltage applications where low input current is a primary consideration.

The AD824 is guaranteed to operate from a 3 V single supply up to  $\pm 15$  V dual supplies. AD824AR-3V Parametric Performance at 3 V is fully guaranteed.

Fabricated on ADI's complementary bipolar process, the AD824 has a unique input stage that allows the input voltage to safely extend beyond the negative supply and to the positive supply without any phase inversion or latchup. The output voltage swings to within 15 mV of the supplies. Capacitive loads to 350 pF can be handled without oscillation.

### PIN CONFIGURATIONS

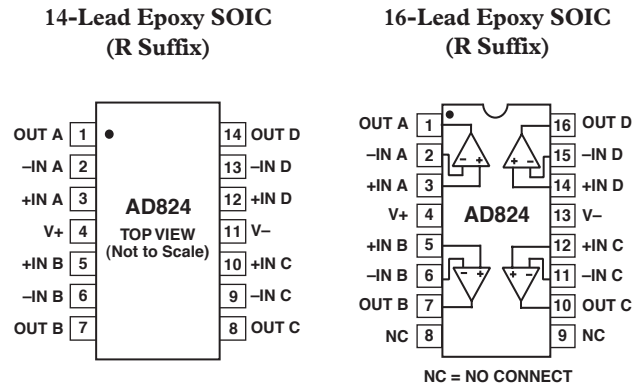

The FET input combined with laser trimming provides an input that has extremely low bias currents with guaranteed offsets below 1 mV. This enables high accuracy designs even with high source impedances. Precision is combined with low noise, making the AD824 ideal for use in battery powered medical equipment.

Applications for the AD824 include portable medical equipment, photo diode preamplifiers and high impedance transducer amplifiers.

The ability of the output to swing rail-to-rail enables designers to build multistage filters in single supply systems and maintain high signal-to-noise ratios.

The AD824 is specified over the extended industrial ( $-40^{\circ}\text{C}$  to  $+85^{\circ}\text{C}$ ) temperature range and is available in narrow 14-lead and 16-lead SOIC packages.

REV. C

Information furnished by Analog Devices is believed to be accurate and reliable. However, no responsibility is assumed by Analog Devices for its use, nor for any infringements of patents or other rights of third parties that may result from its use. No license is granted by implication or otherwise under any patent or patent rights of Analog Devices. Trademarks and registered trademarks are the property of their respective companies.

# AD824—SPECIFICATIONS

## ELECTRICAL SPECIFICATIONS (@ $V_S = 5.0\text{ V}$ , $V_{CM} = 0\text{ V}$ , $V_{OUT} = 0.2\text{ V}$ , $T_A = 25^\circ\text{C}$ unless otherwise noted)

Parameter	Symbol	Conditions	Min	Typ	Max	Unit
<b>INPUT CHARACTERISTICS</b>						
Offset Voltage AD824A	$V_{OS}$	$T_{MIN}$ to $T_{MAX}$		0.1	1.0	mV
Input Bias Current	$I_B$	$T_{MIN}$ to $T_{MAX}$		2	12	pA
Input Offset Current	$I_{OS}$	$T_{MIN}$ to $T_{MAX}$		300	4000	pA
Input Voltage Range		$T_{MIN}$ to $T_{MAX}$		2	10	pA
Common-Mode Rejection Ratio	CMRR	$V_{CM} = 0\text{ V}$ to $2\text{ V}$	-0.2	80	3.0	V
		$V_{CM} = 0\text{ V}$ to $3\text{ V}$	66	74		dB
		$T_{MIN}$ to $T_{MAX}$	60			dB
Input Impedance				$10^{13}  3.3$		$\Omega  \text{pF}$
Large Signal Voltage Gain	$A_{VO}$	$V_O = 0.2\text{ V}$ to $4.0\text{ V}$				
		$R_L = 2\text{ k}\Omega$	20	40		V/mV
		$R_L = 10\text{ k}\Omega$	50	100		V/mV
		$R_L = 100\text{ k}\Omega$	250	1000		V/mV
		$T_{MIN}$ to $T_{MAX}$ , $R_L = 100\text{ k}\Omega$	180	400		V/mV
Offset Voltage Drift	$\Delta V_{OS}/\Delta T$			2		$\mu\text{V}/^\circ\text{C}$
<b>OUTPUT CHARACTERISTICS</b>						
Output Voltage High	$V_{OH}$	$I_{SOURCE} = 20\text{ }\mu\text{A}$	4.975	4.988		V
		$T_{MIN}$ to $T_{MAX}$	4.97	4.985		V
		$I_{SOURCE} = 2.5\text{ mA}$	4.80	4.85		V
		$T_{MIN}$ to $T_{MAX}$	4.75	4.82		V
Output Voltage Low	$V_{OL}$	$I_{SINK} = 20\text{ }\mu\text{A}$		15	25	mV
		$T_{MIN}$ to $T_{MAX}$		20	30	mV
		$I_{SINK} = 2.5\text{ mA}$		120	150	mV
		$T_{MIN}$ to $T_{MAX}$		140	200	mV
Short Circuit Limit	$I_{SC}$	Sink/Source		$\pm 12$		mA
		$T_{MIN}$ to $T_{MAX}$		$\pm 10$		mA
Open-Loop Impedance	$Z_{OUT}$	$f = 1\text{ MHz}$ , $A_V = 1$		100		$\Omega$
<b>POWER SUPPLY</b>						
Power Supply Rejection Ratio	PSRR	$V_S = 2.7\text{ V}$ to $12\text{ V}$	70	80		dB
		$T_{MIN}$ to $T_{MAX}$	66			dB
Supply Current/Amplifier	$I_{SY}$	$T_{MIN}$ to $T_{MAX}$		500	600	$\mu\text{A}$
<b>DYNAMIC PERFORMANCE</b>						
Slew Rate	SR	$R_L = 10\text{ k}\Omega$ , $A_V = 1$		2		V/ $\mu\text{s}$
Full-Power Bandwidth	$BW_P$	1% Distortion, $V_O = 4\text{ V p-p}$		150		kHz
Settling Time	$t_S$	$V_{OUT} = 0.2\text{ V}$ to $4.5\text{ V}$ , to 0.01%		2.5		$\mu\text{s}$
Gain Bandwidth Product	GBP			2		MHz
Phase Margin	$\phi_o$	No Load		50		Degrees
Channel Separation	CS	$f = 1\text{ kHz}$ , $R_L = 2\text{ k}\Omega$		-123		dB
<b>NOISE PERFORMANCE</b>						
Voltage Noise	$e_n\text{ p-p}$	0.1 Hz to 10 Hz		2		$\mu\text{V p-p}$
Voltage Noise Density	$e_n$	$f = 1\text{ kHz}$		16		$\text{nV}/\sqrt{\text{Hz}}$
Current Noise Density	$i_n$	$f = 1\text{ kHz}$		0.8		$\text{fA}/\sqrt{\text{Hz}}$
Total Harmonic Distortion	THD	$f = 10\text{ kHz}$ , $R_L = 0$ , $A_V = +1$		0.005		%

**ELECTRICAL SPECIFICATIONS** (@  $V_S = \pm 15.0\text{ V}$ ,  $V_{OUT} = 0\text{ V}$ ,  $T_A = 25^\circ\text{C}$  unless otherwise noted)

Parameter	Symbol	Conditions	Min	Typ	Max	Unit
<b>INPUT CHARACTERISTICS</b>						
Offset Voltage AD824A	$V_{OS}$	$T_{MIN}$ to $T_{MAX}$		0.5	2.5	mV
Input Bias Current	$I_B$	$V_{CM} = 0\text{ V}$		0.6	4.0	mV
		$T_{MIN}$ to $T_{MAX}$		4	35	pA
Input Offset Current	$I_{OS}$	$V_{CM} = -10\text{ V}$		500	4000	pA
		$T_{MIN}$ to $T_{MAX}$		25		pA
Input Voltage Range		$T_{MIN}$ to $T_{MAX}$		3	20	pA
Common-Mode Rejection Ratio	CMRR	$V_{CM} = -15\text{ V}$ to $13\text{ V}$	-15		13	V
		$T_{MIN}$ to $T_{MAX}$	70	80		dB
Input Impedance						dB
Large Signal Voltage Gain	$A_{VO}$	$V_O = -10\text{ V}$ to $+10\text{ V}$ ; $R_L = 2\text{ k}\Omega$ $R_L = 10\text{ k}\Omega$ $R_L = 100\text{ k}\Omega$ $T_{MIN}$ to $T_{MAX}$ , $R_L = 100\text{ k}\Omega$		$10^{13} \parallel 3.3$		$\Omega \parallel \text{pF}$
				12	50	V/mV
				50	200	V/mV
				300	2000	V/mV
Offset Voltage Drift	$\Delta V_{OS}/\Delta T$		200	1000		V/mV
						$\mu\text{V}/^\circ\text{C}$
<b>OUTPUT CHARACTERISTICS</b>						
Output Voltage High	$V_{OH}$	$I_{SOURCE} = 20\text{ }\mu\text{A}$	14.975	14.988		V
		$T_{MIN}$ to $T_{MAX}$	14.970	14.985		V
		$I_{SOURCE} = 2.5\text{ mA}$	14.80	14.85		V
		$T_{MIN}$ to $T_{MAX}$	14.75	14.82		V
Output Voltage Low	$V_{OL}$	$I_{SINK} = 20\text{ }\mu\text{A}$		-14.985	-14.975	V
		$T_{MIN}$ to $T_{MAX}$		-14.98	-14.97	V
		$I_{SINK} = 2.5\text{ mA}$		-14.88	-14.85	V
		$T_{MIN}$ to $T_{MAX}$		-14.86	-14.8	V
Short Circuit Limit	$I_{SC}$	Sink/Source, $T_{MIN}$ to $T_{MAX}$	$\pm 8$	$\pm 20$		mA
Open-Loop Impedance	$Z_{OUT}$	$f = 1\text{ MHz}$ , $A_V = 1$		100		$\Omega$
<b>POWER SUPPLY</b>						
Power Supply Rejection Ratio	PSRR	$V_S = 2.7\text{ V}$ to $15\text{ V}$ $T_{MIN}$ to $T_{MAX}$	70	80		dB
Supply Current/Amplifier	$I_{SY}$	$V_O = 0\text{ V}$	68			dB
		$T_{MIN}$ to $T_{MAX}$		560	625	$\mu\text{A}$
					675	$\mu\text{A}$
<b>DYNAMIC PERFORMANCE</b>						
Slew Rate	SR	$R_L = 10\text{ k}\Omega$ , $A_V = 1$		2		V/ $\mu\text{s}$
Full-Power Bandwidth	$BW_P$	1% Distortion, $V_O = 20\text{ V p-p}$		33		kHz
Settling Time	$t_S$	$V_{OUT} = 0\text{ V}$ to $10\text{ V}$ , to 0.01%		6		$\mu\text{s}$
Gain Bandwidth Product	GBP			2		MHz
Phase Margin	$\phi_o$			50		Degrees
Channel Separation	CS	$f = 1\text{ kHz}$ , $R_L = 2\text{ k}\Omega$		-123		dB
<b>NOISE PERFORMANCE</b>						
Voltage Noise	$e_n\text{ p-p}$	0.1 Hz to 10 Hz		2		$\mu\text{V p-p}$
Voltage Noise Density	$e_n$	$f = 1\text{ kHz}$		16		$\text{nV}/\sqrt{\text{Hz}}$
Current Noise Density	$i_n$	$f = 1\text{ kHz}$		1.1		$\text{fA}/\sqrt{\text{Hz}}$
Total Harmonic Distortion	THD	$f = 10\text{ kHz}$ , $V_O = 3\text{ V rms}$ , $R_L = 10\text{ k}\Omega$		0.005		%

# AD824—SPECIFICATIONS

## ELECTRICAL SPECIFICATIONS (@ $V_S = 3.0\text{ V}$ , $V_{CM} = 0\text{ V}$ , $V_{OUT} = 0.2\text{ V}$ , $T_A = 25^\circ\text{C}$ unless otherwise noted)

Parameter	Symbol	Conditions	Min	Typ	Max	Unit
<b>INPUT CHARACTERISTICS</b>						
Offset Voltage AD824A -3 V	$V_{OS}$	$T_{MIN}$ to $T_{MAX}$		0.2	1.0	mV
Input Bias Current	$I_B$	$T_{MIN}$ to $T_{MAX}$		2	12	pA
Input Offset Current	$I_{OS}$	$T_{MIN}$ to $T_{MAX}$		250	4000	pA
Input Voltage Range		$T_{MIN}$ to $T_{MAX}$		2	10	pA
Common-Mode Rejection Ratio	CMRR	$V_{CM} = 0\text{ V}$ to $1\text{ V}$ $T_{MIN}$ to $T_{MAX}$	0 58	74	1	V dB
Input Impedance				$10^{13}  3.3$		$\Omega  \text{pF}$
Large Signal Voltage Gain	$A_{VO}$	$V_O = 0.2\text{ V}$ to $2.0\text{ V}$ $R_L = 2\text{ k}\Omega$ $R_L = 10\text{ k}\Omega$ $R_L = 100\text{ k}\Omega$ $T_{MIN}$ to $T_{MAX}$ , $R_L = 100\text{ k}\Omega$	10 30 180 90	20 65 500 250		V/mV V/mV V/mV V/mV
Offset Voltage Drift	$\Delta V_{OS}/\Delta T$			2		$\mu\text{V}/^\circ\text{C}$
<b>OUTPUT CHARACTERISTICS</b>						
Output Voltage High	$V_{OH}$	$I_{SOURCE} = 20\text{ }\mu\text{A}$ $T_{MIN}$ to $T_{MAX}$	2.975 2.97	2.988 2.985		V V
Output Voltage Low	$V_{OL}$	$I_{SOURCE} = 2.5\text{ mA}$ $T_{MIN}$ to $T_{MAX}$ $I_{SINK} = 20\text{ }\mu\text{A}$ $T_{MIN}$ to $T_{MAX}$ $I_{SINK} = 2.5\text{ mA}$ $T_{MIN}$ to $T_{MAX}$	2.8 2.75	2.85 2.82		V V
Short Circuit Limit	$I_{SC}$	Sink/Source		$\pm 8$	25	mV mV
Open-Loop Impedance	$I_{SC}$ $Z_{OUT}$	Sink/Source, $T_{MIN}$ to $T_{MAX}$ $f = 1\text{ MHz}$ , $A_V = 1$		$\pm 6$ 100	150 200	mV mA mA $\Omega$
<b>POWER SUPPLY</b>						
Power Supply Rejection Ratio	PSRR	$V_S = 2.7\text{ V}$ to $12\text{ V}$ , $T_{MIN}$ to $T_{MAX}$	70 66			dB dB
Supply Current/Amplifier	$I_{SY}$	$V_O = 0.2\text{ V}$ , $T_{MIN}$ to $T_{MAX}$		500	600	$\mu\text{A}$
<b>DYNAMIC PERFORMANCE</b>						
Slew Rate	SR	$R_L = 10\text{ k}\Omega$ , $A_V = 1$		2		V/ $\mu\text{s}$
Full-Power Bandwidth	$BW_P$	1% Distortion, $V_O = 2\text{ V p-p}$		300		kHz
Settling Time	$t_S$	$V_{OUT} = 0.2\text{ V}$ to $2.5\text{ V}$ , to 0.01%		2		$\mu\text{s}$
Gain Bandwidth Product	GBP			2		MHz
Phase Margin	$\phi_o$			50		Degrees
Channel Separation	CS	$f = 1\text{ kHz}$ , $R_L = 2\text{ k}\Omega$		-123		dB
<b>NOISE PERFORMANCE</b>						
Voltage Noise	$e_n\text{ p-p}$	0.1 Hz to 10 Hz		2		$\mu\text{V p-p}$
Voltage Noise Density	$e_n$	$f = 1\text{ kHz}$		16		$\text{nV}/\sqrt{\text{Hz}}$
Current Noise Density	$i_n$			0.8		$\text{fA}/\sqrt{\text{Hz}}$
Total Harmonic Distortion	THD	$f = 10\text{ kHz}$ , $R_L = 0$ , $A_V = +1$		0.01		%

## WAFER TEST LIMITS (@ $V_S = 5.0\text{ V}$ , $V_{CM} = 0\text{ V}$ , $T_A = 25^\circ\text{C}$ unless otherwise noted)

Parameter	Symbol	Conditions	Limit	Unit
Offset Voltage	$V_{OS}$		1.0	mV max
Input Bias Current	$I_B$		12	pA max
Input Offset Current	$I_{OS}$		20	pA
Input Voltage Range	$V_{CM}$		-0.2 to 3.0	V min
Common-Mode Rejection Ratio	CMRR	$V_{CM} = 0\text{ V to } 2\text{ V}$	66	dB min
Power Supply Rejection Ratio	PSRR	$V = +2.7\text{ V to } +12\text{ V}$	70	$\mu\text{V/V}$
Large Signal Voltage Gain	$A_{VO}$	$R_L = 2\text{ k}\Omega$	15	V/mV min
Output Voltage High	$V_{OH}$	$I_{SOURCE} = 20\ \mu\text{A}$	4.975	V min
Output Voltage Low	$V_{OL}$	$I_{SINK} = 20\ \mu\text{A}$	25	mV max
Supply Current/Amplifier	$I_{SY}$	$V_O = 0\text{ V}$ , $R_L = \infty$	600	$\mu\text{A max}$

## NOTE

Electrical tests and wafer probe to the limits shown. Due to variations in assembly methods and normal yield loss, yield after packaging is not guaranteed for standard product dice. Consult factory to negotiate specifications based on dice lot qualifications through sample lot assembly and testing.

### ABSOLUTE MAXIMUM RATINGS<sup>1</sup>

Supply Voltage	$\pm 18\text{ V}$
Input Voltage	$-V_S - 0.2\text{ V to } +V_S$
Differential Input Voltage	$\pm 30\text{ V}$
Output Short Circuit Duration to GND	Indefinite
Storage Temperature Range	
R-14, R-16 Packages	$-65^\circ\text{C to } +150^\circ\text{C}$
Operating Temperature Range	
AD824A	$-40^\circ\text{C to } +85^\circ\text{C}$
Junction Temperature Range	
R-14, R-16 Packages	$-65^\circ\text{C to } +150^\circ\text{C}$
Lead Temperature Range (Soldering 60 sec)	$300^\circ\text{C}$

Package Type	$\theta_{JA}$ <sup>2</sup>	$\theta_{JC}$	Unit
14-Lead SOIC (R)	120	36	$^\circ\text{C/W}$
16-Lead SOIC (R)	92	27	$^\circ\text{C/W}$

## NOTES

<sup>1</sup> Absolute maximum ratings apply to packaged parts unless otherwise noted.

<sup>2</sup>  $\theta_{JA}$  is specified for the worst case conditions, i.e.,  $\theta_{JA}$  is specified for device in socket for P-DIP packages;  $\theta_{JA}$  is specified for device soldered in circuit board for SOIC package.

### ORDERING GUIDE

Model	Temperature Range	Package Description	Package Option
AD824AR-14	$-40^\circ\text{C to } +85^\circ\text{C}$	14-Pin SOIC	R-14
AD824AR-14-3V	$-40^\circ\text{C to } +85^\circ\text{C}$	14-Pin SOIC	R-14
AD824AR-16	$-40^\circ\text{C to } +85^\circ\text{C}$	16-Pin SOIC	R-16

### CAUTION

ESD (electrostatic discharge) sensitive device. Electrostatic charges as high as 4000 V readily accumulate on the human body and test equipment and can discharge without detection. Although the AD824 features proprietary ESD protection circuitry, permanent damage may occur on devices subjected to high-energy electrostatic discharges. Therefore, proper ESD precautions are recommended to avoid performance degradation or loss of functionality.

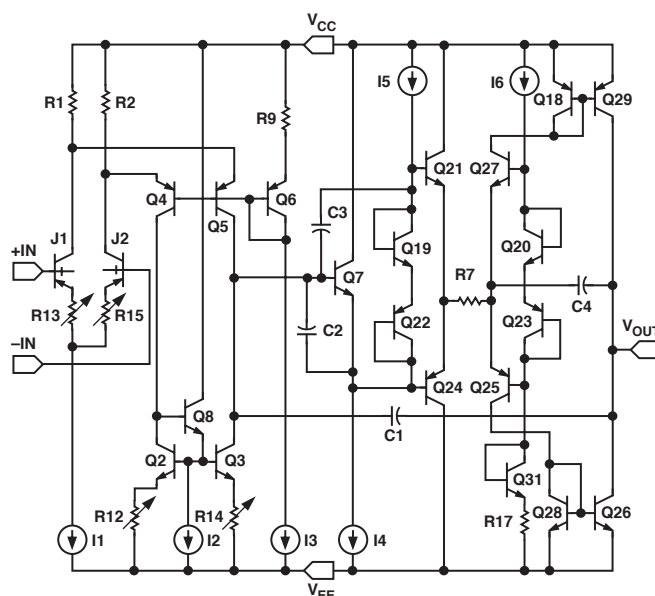
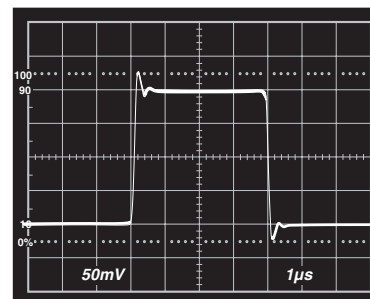
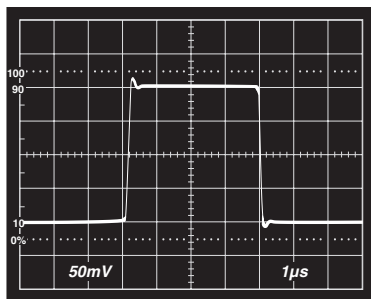
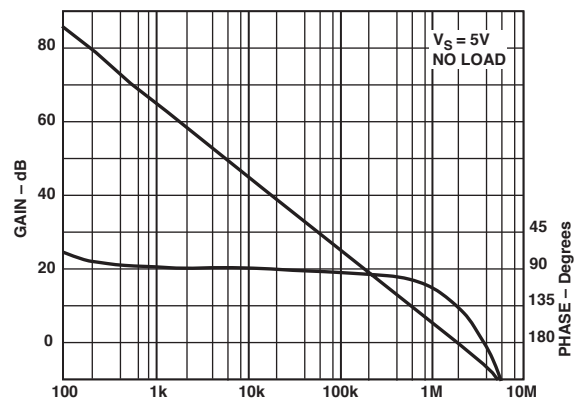
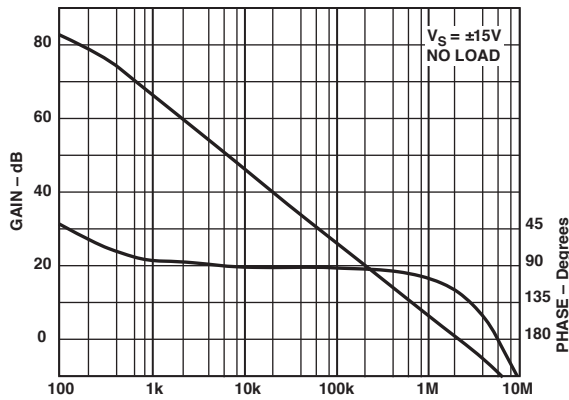

Figure 1. Simplified Schematic of 1/4 AD824



# AD824 – Typical Performance Characteristics



TPC 1. Open-Loop Gain/Phase and Small Signal Response,  $V_S = \pm 15\text{ V}$ , No Load

TPC 3. Open-Loop Gain/Phase and Small Signal Response,  $V_S = 5\text{ V}$ , No Load

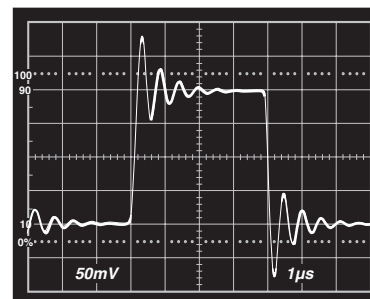
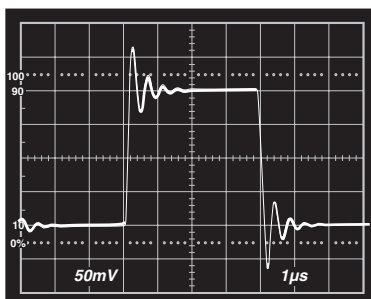
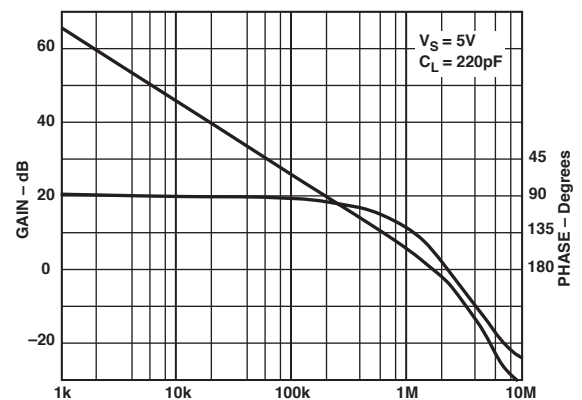
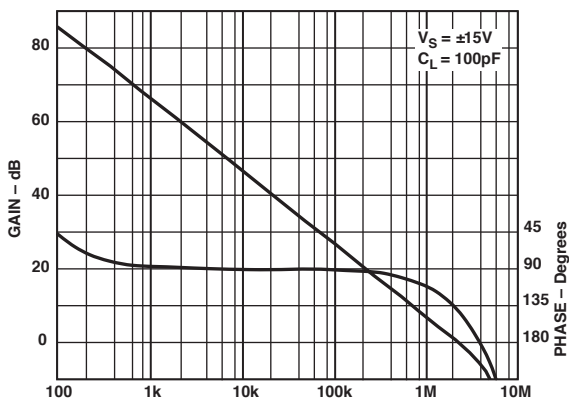

TPC 2. Open-Loop Gain/Phase and Small Signal Response,  $V_S = \pm 15\text{ V}$ ,  $C_L = 100\text{ pF}$

TPC 4. Open-Loop Gain/Phase and Small Signal Response,  $V_S = 5\text{ V}$ ,  $C_L = 220\text{ pF}$

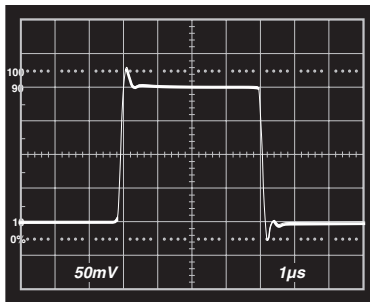
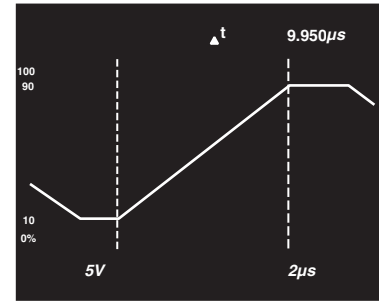
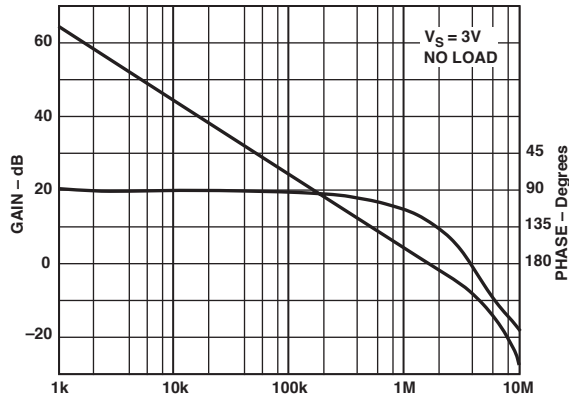

TPC 5. Open-Loop Gain/Phase and Small Signal Response,  $V_S = 3\text{ V}$ , No Load

TPC 7. Slew Rate,  $R_L = 10\text{ k}$

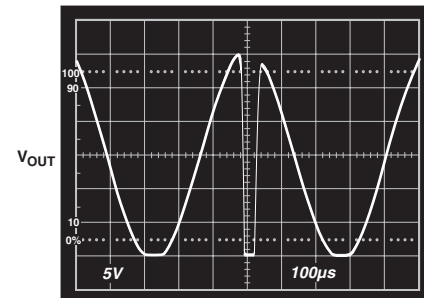
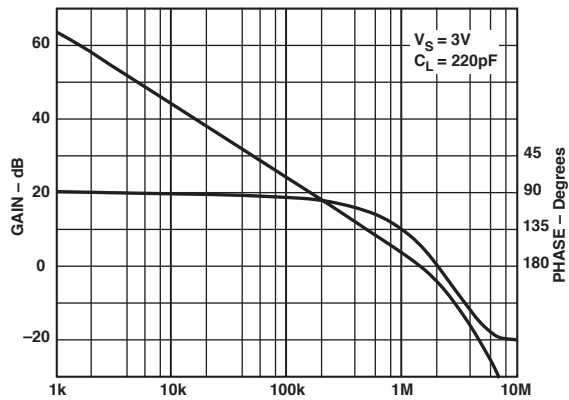

TPC 8. Phase Reversal with Inputs Exceeding Supply by 1 V

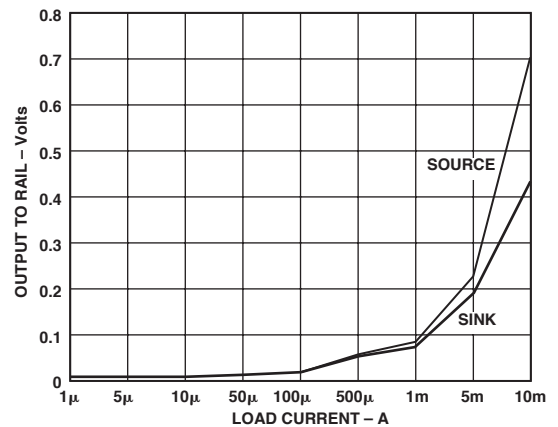
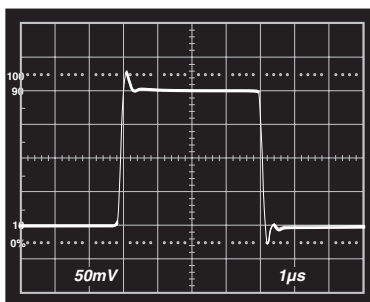

TPC 6. Open-Loop Gain/Phase and Small Signal Response,  $V_S = 3\text{ V}$ ,  $C_L = 220\text{ pF}$

TPC 9. Output Voltage to Supply Rail vs. Sink and Source Load Currents

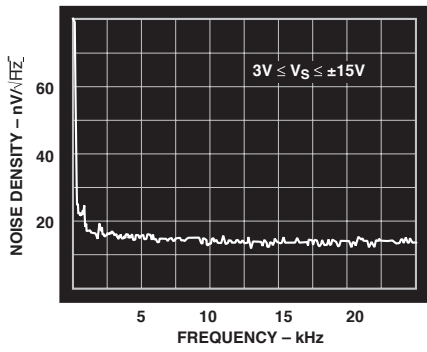

TPC 10. Voltage Noise Density

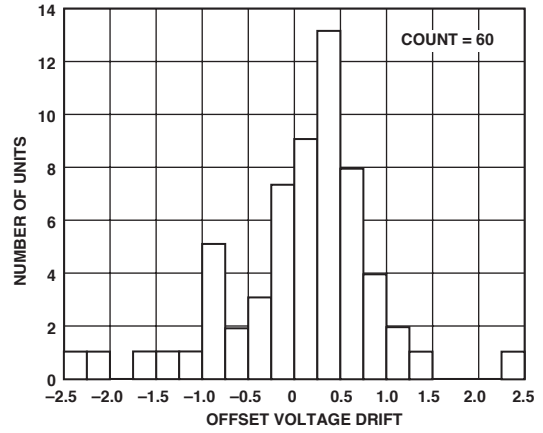

TPC 13. TC  $V_{OS}$  Distribution,  $-55^{\circ}\text{C}$  to  $+125^{\circ}\text{C}$ ,  $V_S = 5, 0$

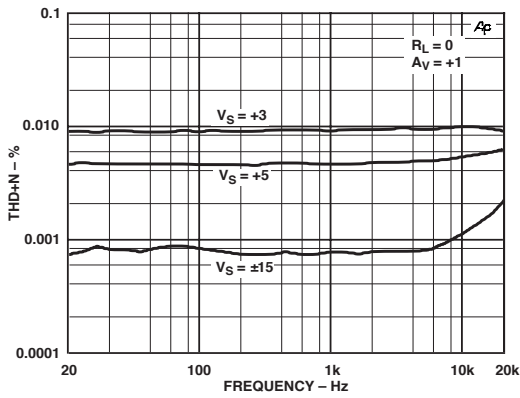

TPC 11. Total Harmonic Distortion

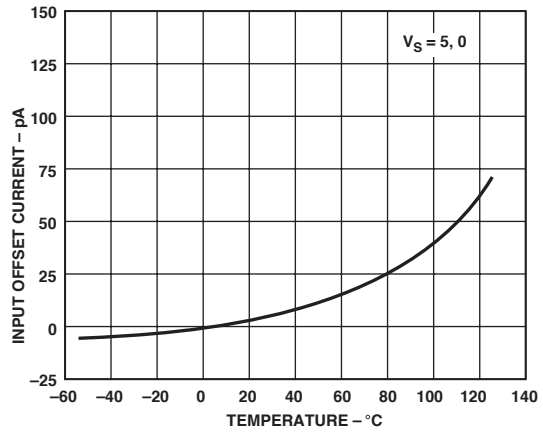

TPC 14. Input Offset Current vs. Temperature

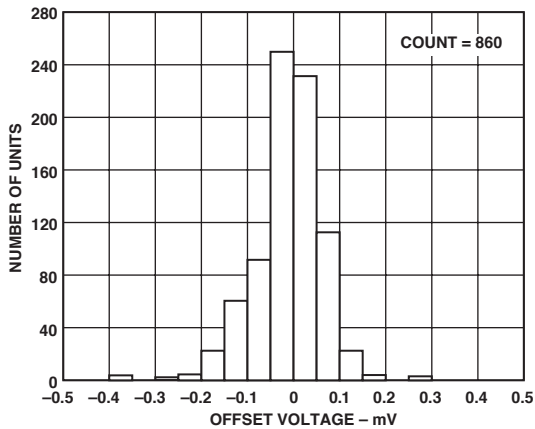

TPC 12. Input Offset Distribution,  $V_S = 5, 0$

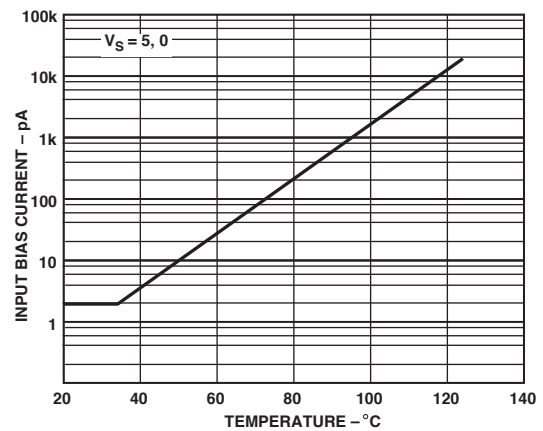

TPC 15. Input Bias Current vs. Temperature

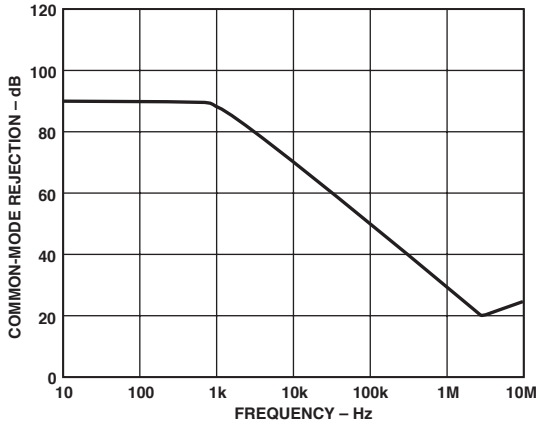

TPC 16. Common-Mode Rejection vs. Frequency

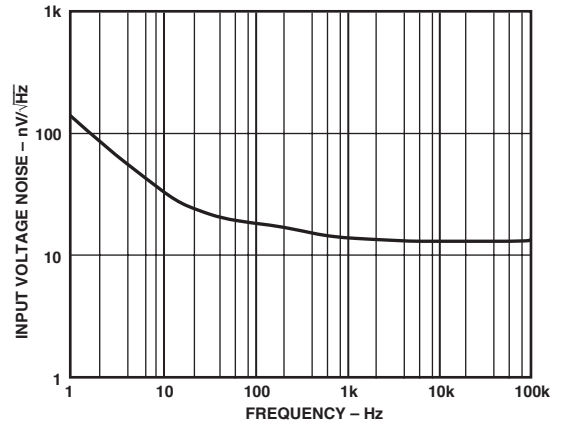

TPC 19. Input Voltage Noise Spectral Density vs. Frequency

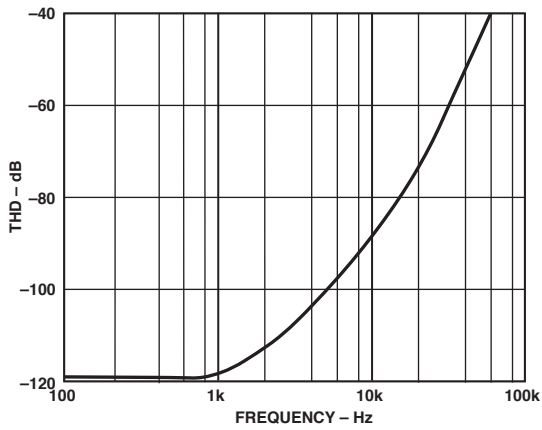

TPC 17. THD vs. Frequency, 3 V rms

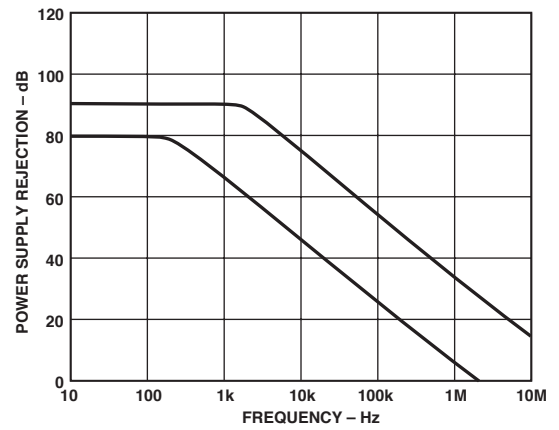

TPC 20. Power Supply Rejection vs. Frequency

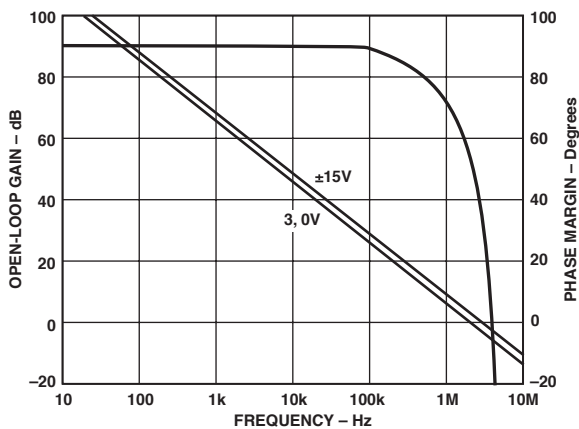

TPC 18. Open-Loop Gain and Phase vs. Frequency

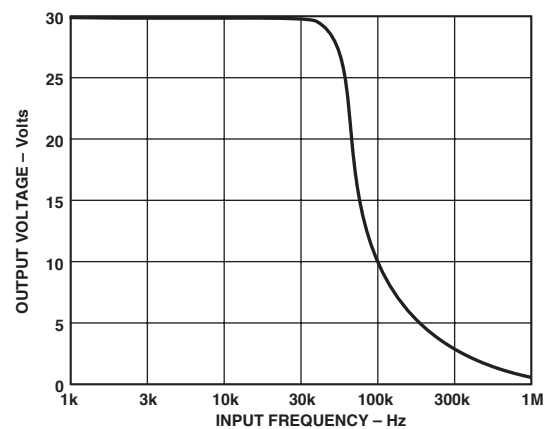

TPC 21. Large Signal Frequency Response

# AD824

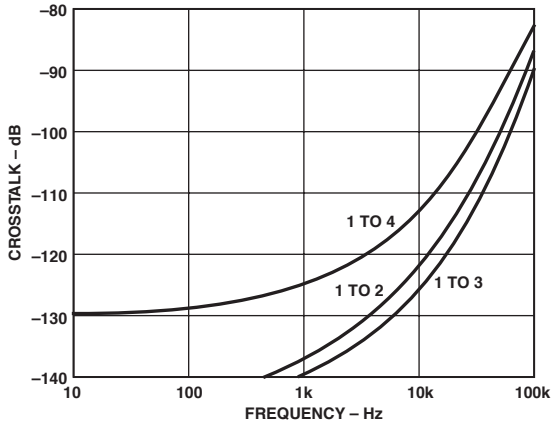

TPC 22. Crosstalk vs. Frequency

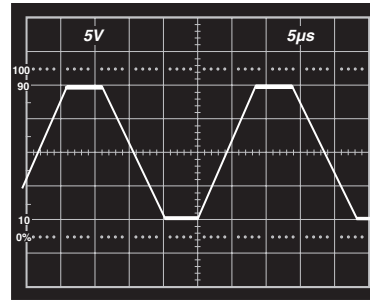

TPC 25. Large Signal Response

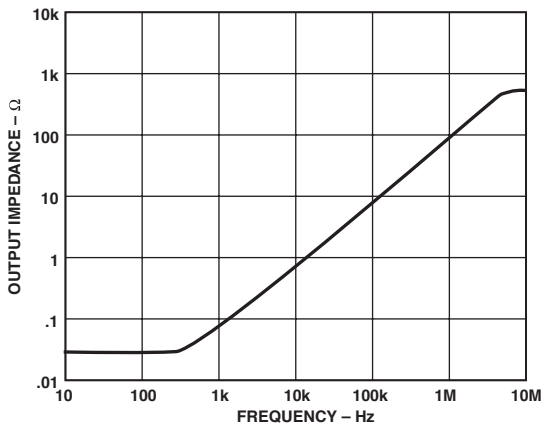

TPC 23. Output Impedance vs. Frequency, Gain = +1

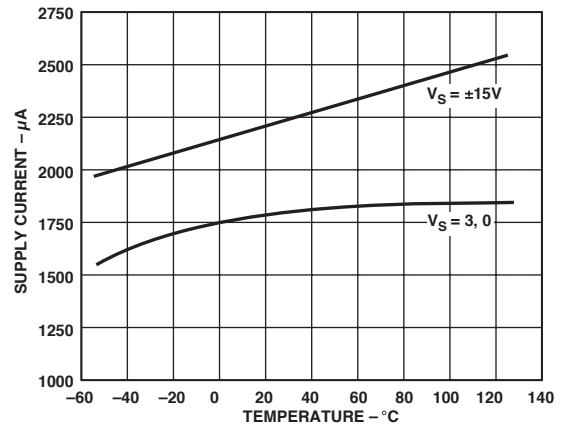

TPC 26. Supply Current vs. Temperature

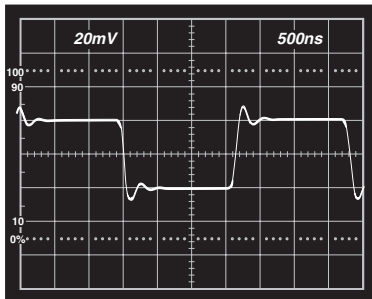

TPC 24. Small Signal Response, Unity Gain Follower, 10k||100 pF Load

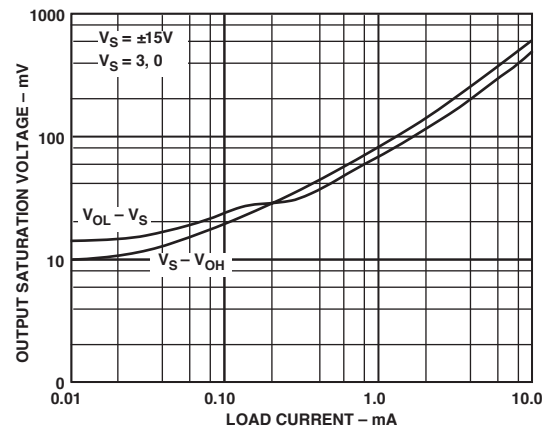

TPC 27. Output Saturation Voltage

## APPLICATION NOTES

## INPUT CHARACTERISTICS

In the AD824, n-channel JFETs are used to provide a low offset, low noise, high impedance input stage. Minimum input common-mode voltage extends from 0.2 V below  $-V_S$  to 1 V less than  $+V_S$ . Driving the input voltage closer to the positive rail will cause a loss of amplifier bandwidth.

The AD824 does not exhibit phase reversal for input voltages up to and including  $+V_S$ . Figure 2a shows the response of an AD824 voltage follower to a 0 V to 5 V ( $+V_S$ ) square wave input. The input and output are superimposed. The output tracks the input up to  $+V_S$  without phase reversal. The reduced bandwidth above a 4 V input causes the rounding of the output wave form. For input voltages greater than  $+V_S$ , a resistor in series with the AD824's noninverting input will prevent phase reversal at the expense of greater input voltage noise. This is illustrated in Figure 2b.

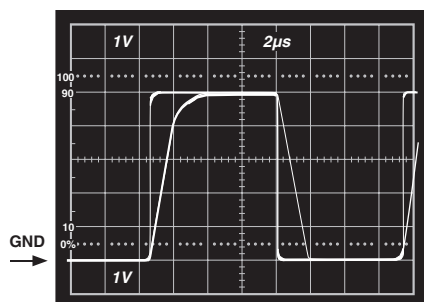

(a)

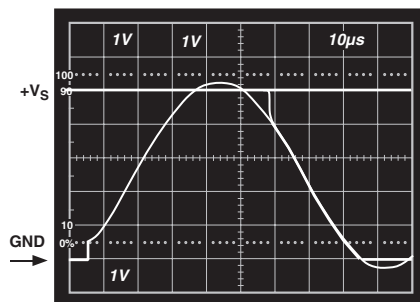

(b)

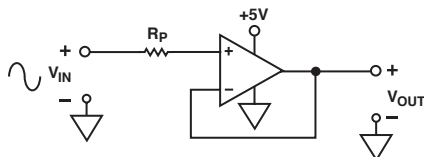

Figure 2. (a) Response with  $R_P = 0$ ;  $V_{IN}$  from 0 to  $+V_S$

(b)  $V_{IN} = 0$  to  $+V_S + 200$  mV

$V_{OUT} = 0$  to  $+V_S$

$R_P = 49.9$  k $\Omega$

Since the input stage uses n-channel JFETs, input current during normal operation is positive; the current flows out from the input terminals. If the input voltage is driven more positive than  $+V_S - 0.4$  V, the input current will reverse direction as internal device junctions become forward biased. This is illustrated in TPC 8.

A current-limiting resistor should be used in series with the input of the AD824 if there is a possibility of the input voltage exceeding the positive supply by more than 300 mV or if an input voltage will be applied to the AD824 when  $\pm V_S = 0$ . The amplifier will be damaged if left in that condition for more than 10 seconds. A 1 k $\Omega$  resistor allows the amplifier to withstand up to 10 V of continuous overvoltage and increases the input voltage noise by a negligible amount.

Input voltages less than  $-V_S$  are a completely different story. The amplifier can safely withstand input voltages 20 V below the minus supply voltage as long as the total voltage from the positive supply to the input terminal is less than 36 V. In addition, the input stage typically maintains picoamp level input currents across that input voltage range.

## OUTPUT CHARACTERISTICS

The AD824's unique bipolar rail-to-rail output stage swings within 15 mV of the positive and negative supply voltages. The AD824's approximate output saturation resistance is 100  $\Omega$  for both sourcing and sinking. This can be used to estimate output saturation voltage when driving heavier current loads. For instance, the saturation voltage will be 0.5 V from either supply with a 5 mA current load.

For load resistances over 20 k $\Omega$ , the AD824's input error voltage is virtually unchanged until the output voltage is driven to 180 mV of either supply.

If the AD824's output is overdriven so as to saturate either of the output devices, the amplifier will recover within 2  $\mu$ s of its input returning to the amplifier's linear operating region.

Direct capacitive loads will interact with the amplifier's effective output impedance to form an additional pole in the amplifier's feedback loop, which can cause excessive peaking on the pulse response or loss of stability. Worst case is when the amplifier is used as a unity gain follower. TPC 4 and 6 show the AD824's pulse response as a unity gain follower driving 220 pF. Configurations with less loop gain, and as a result less loop bandwidth, will be much less sensitive to capacitance load effects. Noise gain is the inverse of the feedback attenuation factor provided by the feedback network in use.

Figure 3 shows a method for extending capacitance load drive capability for a unity gain follower. With these component values, the circuit will drive 5,000 pF with a 10% overshoot.

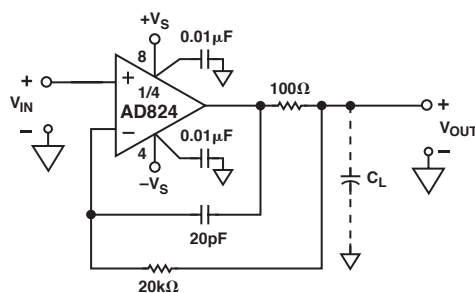

Figure 3. Extending Unity Gain Follower Capacitive Load Capability Beyond 350 pF

# AD824

## APPLICATIONS

### Single Supply Voltage-to-Frequency Converter

The circuit shown in Figure 4 uses the AD824 to drive a low power timer, which produces a stable pulse of width  $t_1$ . The positive going output pulse is integrated by R1-C1 and used as one input to the AD824, which is connected as a differential integrator. The other input (nonloading) is the unknown voltage,  $V_{IN}$ . The AD824 output drives the timer trigger input, closing the overall feedback loop.

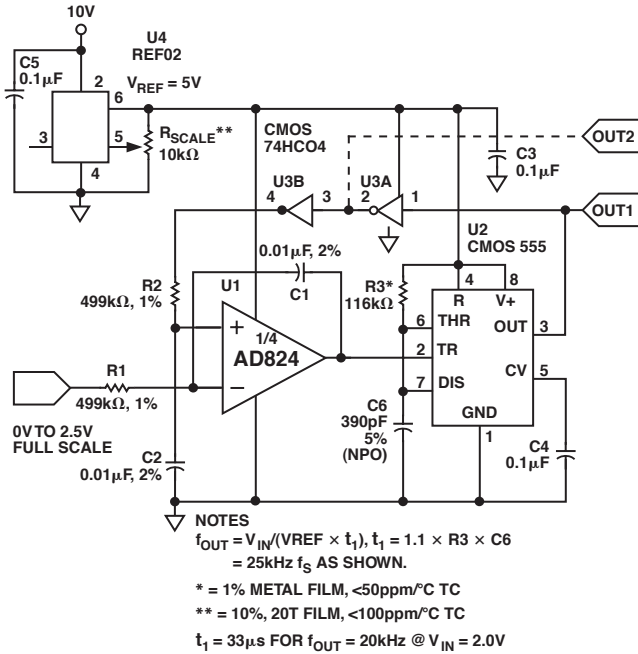

Figure 4. Single Supply Voltage-to-Frequency Converter

Typical AD824 bias currents of 2 pA allow megaohm-range source impedances with negligible dc errors. Linearity errors on the order of 0.01% full scale can be achieved with this circuit. This performance is obtained with a 5 V single supply, which delivers less than 3 mA to the entire circuit.

### Single Supply Programmable Gain Instrumentation Amplifier

The AD824 can be configured as a single supply instrumentation amplifier that is able to operate from single supplies down to 5 V or dual supplies up to  $\pm 15$  V. AD824 FET inputs' 2 pA bias currents minimize offset errors caused by high unbalanced source impedances.

An array of precision thin-film resistors sets the in amp gain to be either 10 or 100. These resistors are laser-trimmed to ratio match to 0.01% and have a maximum differential TC of 5 ppm/°C.

Table I. AD824 In Amp Performance

Parameters	$V_S = 3\text{ V}, 0\text{ V}$	$V_S = \pm 5\text{ V}$
CMRR	74 dB	80 dB
Common-Mode Voltage Range	-0.2 V to +2 V	-5.2 V to +4 V
3 dB BW, $G = 10$	180 kHz	180 kHz
$G = 100$	18 kHz	18 kHz
$t_{SETTLING}$		
2 V Step ( $V_S = 0\text{ V}, 3\text{ V}$ )	2 $\mu\text{s}$	
5 V ( $V_S = \pm 5\text{ V}$ )		5 $\mu\text{s}$
Noise @ $f = 1\text{ kHz}$ , $G = 10$	270 $\text{nV}/\sqrt{\text{Hz}}$	270 $\text{nV}/\sqrt{\text{Hz}}$
$G = 100$	2.2 $\mu\text{V}/\sqrt{\text{Hz}}$	2.2 $\mu\text{V}/\sqrt{\text{Hz}}$

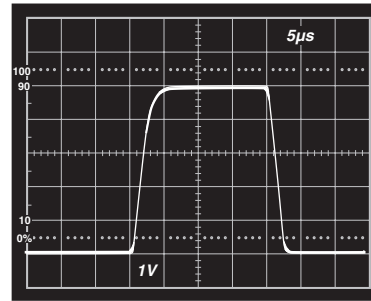

Figure 5a. Pulse Response of In Amp to a 500 mV p-p Input Signal;  $V_S = 5\text{ V}, 0\text{ V}$ ; Gain = 10

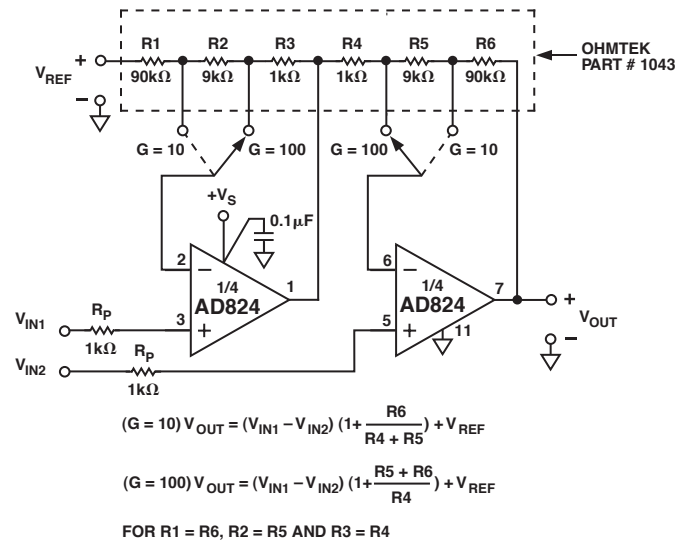

Figure 5b. A Single Supply Programmable Instrumentation Amplifier

### 3 Volt, Single Supply Stereo Headphone Driver

The AD824 exhibits good current drive and THD+N performance, even at 3 V single supplies. At 1 kHz, total harmonic distortion plus noise (THD+N) equals -62 dB (0.079%) for a 300 mV p-p output signal. This is comparable to other single supply op amps that consume more power and cannot run on 3 V power supplies.

In Figure 6, each channel's input signal is coupled via a 1 μF Mylar capacitor. Resistor dividers set the dc voltage at the noninverting inputs so that the output voltage is midway between the power supplies (1.5 V). The gain is 1.5. Each half of the AD824 can then be used to drive a headphone channel. A 5 Hz high-pass filter is realized by the 500 μF capacitors and the headphones, which can be modeled as 32 ohm load resistors to ground. This ensures that all signals in the audio frequency range (20 Hz–20 kHz) are delivered to the headphones.

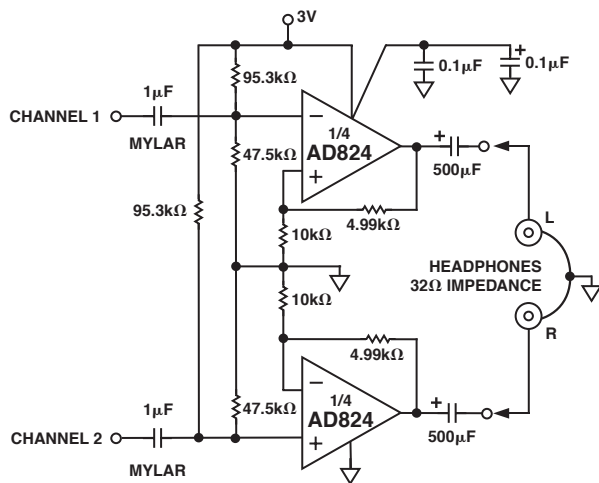

Figure 6. 3 Volt Single Supply Stereo Headphone Driver

### Low Dropout Bipolar Bridge Driver

The AD824 can be used for driving a 350 ohm Wheatstone bridge. Figure 7 shows one half of the AD824 being used to buffer the AD589—a 1.235 V low power reference. The output

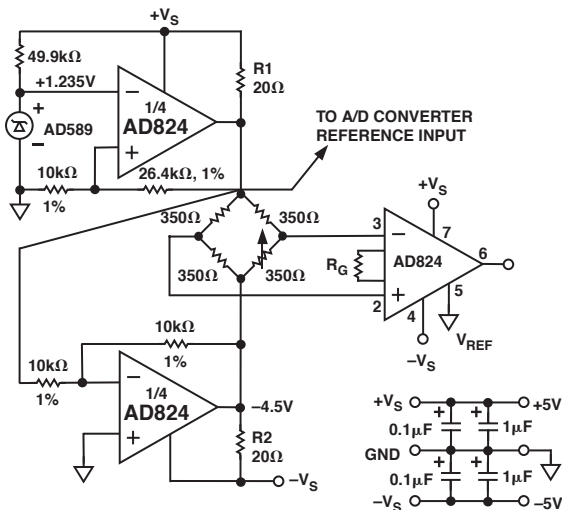

Figure 7. Low Dropout Bipolar Bridge Driver

of 4.5 V can be used to drive an A/D converter front end. The other half of the AD824 is configured as a unity-gain inverter and generates the other bridge input of -4.5 V. Resistors R1 and R2 provide a constant current for bridge excitation. The AD620 low power instrumentation amplifier is used to condition the differential output voltage of the bridge. The gain of the AD620 is programmed using an external resistor  $R_G$  and determined by:

$$G = \frac{49.4 \text{ k}\Omega}{R_G} + 1$$

### A 3.3 V/5 V Precision Sample-and-Hold Amplifier

In battery-powered applications, low supply voltage operational amplifiers are required for low power consumption. Also, low supply voltage applications limit the signal range in precision analog circuitry. Circuits like the sample-and-hold circuit shown in Figure 8, illustrate techniques for designing precision analog circuitry in low supply voltage applications. To maintain high signal-to-noise ratios (SNRs) in a low supply voltage application requires the use of rail-to-rail, input/output operational amplifiers. This design highlights the ability of the AD824 to operate rail-to-rail from a single 3 V/5 V supply, with the advantages of high input impedance. The AD824, a quad JFET-input op amp, is well suited to S/H circuits due to its low input bias currents (3 pA, typical) and high input impedances ( $3 \times 10^{13} \Omega$ , typical). The AD824 also exhibits very low supply currents so the total supply current in this circuit is less than 2.5 mA.

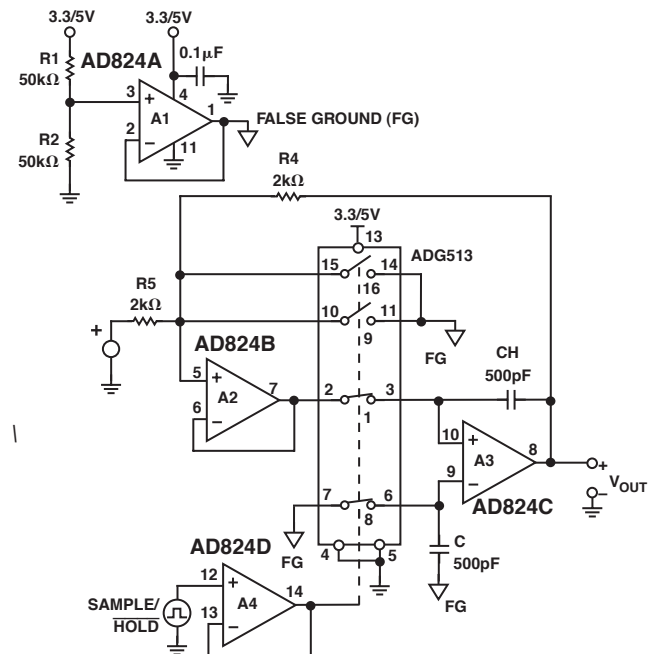

Figure 8. 3.3 V/5.5 V Precision Sample and Hold

In many single supply applications, the use of a false ground generator is required. In this circuit, R1 and R2 divide the supply voltage symmetrically, creating the false ground voltage at one-half the supply. Amplifier A1 then buffers this voltage creating a low impedance output drive. The S/H circuit is configured in an inverting topology centered around this false ground level.

## AD824

A design consideration in sample-and-hold circuits is voltage droop at the output caused by op amp bias and switch leakage currents. By choosing a JFET op amp and a low leakage CMOS switch, this design minimizes droop rate error to better than  $0.1 \mu\text{V}/\mu\text{s}$  in this circuit. Higher values of  $C_H$  will yield a lower droop rate. For best performance,  $C_H$  and  $C_2$  should be polystyrene, polypropylene or Teflon capacitors. These types of capacitors exhibit low leakage and low dielectric absorption. Additionally, 1% metal film resistors were used throughout the design.

In the sample mode, SW1 and SW4 are closed, and the output is  $V_{\text{OUT}} = -V_{\text{IN}}$ . The purpose of SW4, which operates in parallel with SW1, is to reduce the pedestal, or hold step, error by injecting the same amount of charge into the noninverting input of A3 that SW1 injects into the inverting input of A3. This creates a common-mode voltage across the inputs of A3 and is then rejected by the CMR of A3; otherwise, the charge injection from SW1 would create a differential voltage step error that would appear at  $V_{\text{OUT}}$ . The pedestal error for this circuit is

less than 2 mV over the entire 0 V to 3.3 V/5 V signal range. Another method of reducing pedestal error is to reduce the pulse amplitude applied to the control pins. In order to control the ADG513, only 2.4 V are required for the “ON” state and 0.8 V for the “OFF” state. If possible, use an input control signal whose amplitude ranges from 0.8 V to 2.4 V instead of a full range 0 V to 3.3 V/5 V for minimum pedestal error.

Other circuit features include an acquisition time of less than  $3 \mu\text{s}$  to 1%; reducing  $C_H$  and  $C_2$  will speed up the acquisition time further, but an increased pedestal error will result. Settling time is less than 300 ns to 1%, and the sample-mode signal BW is 80 kHz.

The ADG513 was chosen for its ability to work with 3 V/5 V supplies and for having normallyopen and normallyclosed precision CMOS switches on a dielectrically isolated process. SW2 is not required in this circuit; however, it was used in parallel with SW3 to provide a lower  $R_{\text{ON}}$  analog switch.

```

* AD824 SPICE Macro-model      9/94, Rev. A *
                                G15 98
                                (9,98) 1E-6
                                *
                                * OUTPUT STAGE
                                *
                                ES 26
                                (18,98) 1
                                RS 26
                                500
                                IB1 98
                                2.404E-3
                                IB2 23
                                2.404E-3
                                D10 21
                                DY
                                D11 98
                                DY
                                C16 20
                                2E-12
                                C17 24
                                2E-12
                                DQ197
                                DQ
                                Q2 20
                                22 NPN
                                Q3 24
                                22 PNP
                                DQ224
                                DQ
                                Q5 25
                                97 PNP 20
                                Q6 25
                                51 NPN 20
                                VP 96
                                0
                                VN 51
                                0
                                EP 96
                                (99,0) 1
                                EN 52
                                (50,0) 1
                                R25 30
                                5E6
                                R26 30
                                5E6
                                FSY1
                                0 VP 1
                                FSY2
                                50VN 1
                                DC1 25
                                DX
                                DC2 50
                                DX
                                *
                                * MODELS USED
                                *
                                .MODEL JX NJF(BETA=3.2526E-3 VTO=-2.000 IS=2E-12) .MODEL
                                NPN NPN(BF=120 VAF=150 VAR=15 RB=2E3
                                + RE=4 RC=550 IS=1E-16)
                                .MODEL PNP PNP(BF=120 VAF=150 VAR=15 RB=2E3 + RE=4
                                RC=750 IS=1E-16)
                                .MODEL DX D(IS=1E-15)
                                .MODEL DY D()
                                .MODEL DQ D(IS=1E-16)
                                .ENDS AD824

                                ARG/ADI
                                *
                                * Copyright 1994 by Analog Devices, Inc.
                                *
                                * Refer to "README.DOC" file for License Statement.
                                Use of this model indicates your acceptance with
                                the terms and provisions in the License Statement. *
                                * Node assignments
                                *
                                | noninverting input
                                | | inverting input
                                * | | positive supply
                                * | | negative supply
                                * | | | output
                                * | | | |
                                .SUBCKT AD824
                                1 2 99 50 25
                                *
                                * INPUT STAGE & POLE AT 3.1 MHz
                                *
                                R3 5
                                1.193E3
                                R4 6
                                1.193E3
                                CIN 1
                                4E-12
                                C2 5
                                19.229E-12
                                I1 4 50
                                108E-6
                                IOS 1
                                1E-12
                                EOS 7
                                1
                                POLY(1) (12,98) 100E-6 1
                                J1 4 2
                                JX
                                J2 4 7
                                JX
                                *
                                * GAIN STAGE & DOMINANT POLE
                                *
                                EREF
                                0 (30,0) 1
                                R5 9
                                2.205E6
                                C3 9
                                54E-12
                                G1 98
                                (6,5) 0.838E-3
                                V1 8
                                -1
                                V2 98
                                -1
                                D1 9
                                DX
                                D2 8
                                DX
                                *
                                * COMMON-MODE GAIN NETWORK WITH ZERO AT 1 kHz *
                                R21 11
                                1E6
                                R22 12
                                100
                                C14 11
                                159E-12
                                E13 11
                                POLY(2) (2,98) (1,98) 0 0.5 0.5
                                *
                                * POLE AT 10 MHz
                                *
                                R23 18
                                1E6
                                C15 18
                                15.9E-15

```

OUTLINE DIMENSIONS

14-Lead Standard Small Outline Package [SOIC]  
Narrow Body  
(R-14)

Dimensions shown in millimeters and (inches)

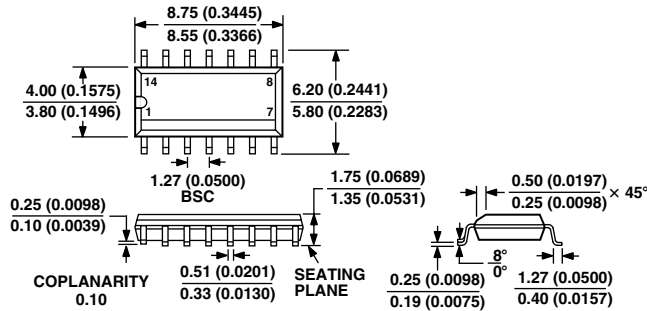

COMPLIANT TO JEDEC STANDARDS MS-012AB  
CONTROLLING DIMENSIONS ARE IN MILLIMETERS; INCH DIMENSIONS  
(IN PARENTHESES) ARE ROUNDED-OFF MILLIMETER EQUIVALENTS FOR  
REFERENCE ONLY AND ARE NOT APPROPRIATE FOR USE IN DESIGN

16-Lead Standard Small Outline Package [SOIC]  
Wide Body  
(R-16)

Dimensions shown in millimeters and (inches)

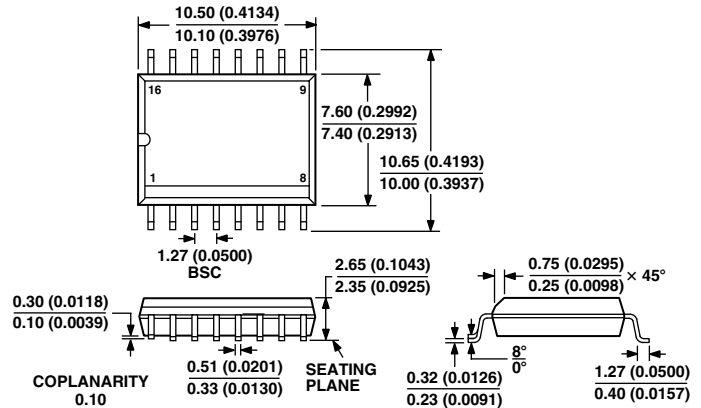

COMPLIANT TO JEDEC STANDARDS MS-013AA  
CONTROLLING DIMENSIONS ARE IN MILLIMETERS; INCH DIMENSIONS  
(IN PARENTHESES) ARE ROUNDED-OFF MILLIMETER EQUIVALENTS FOR  
REFERENCE ONLY AND ARE NOT APPROPRIATE FOR USE IN DESIGN

Revision History

Location	Page
<b>2/03–Data Sheet changed from REV. B to REV. C.</b>	
Deleted N Package	Universal
Edits to GENERAL DESCRIPTION	1
Edits to ABSOLUTE MAXIMUM RATINGS	5
Edits to ORDERING GUIDE	5
Edits to Figure 4	12
Edits to Figure 8	13
Updated OUTLINE DIMENSIONS	16
<b>1/02–Data Sheet changed from REV. A to REV. B.</b>	
Edits to ELECTRICAL SPECIFICATIONS	2, 3
Edits to ABSOLUTE MAXIMUM RATINGS	5
Edits to ORDERING GUIDE	5
Deleted DICE CHARACTERISTICS	5