

AD8519/AD8529

FEATURES

Space-Saving SOT-23, μ SOIC Packaging
 Wide Bandwidth: 8 MHz @ 5 V
 Low Offset Voltage: 1.2 mV Max
 Rail-to-Rail Output Swing
 2.7 V/ μ s Slew Rate
 Unity Gain Stable
 Single Supply Operation: +2.7 V to +12 V

APPLICATIONS

Portable Communications
 Microphone Amplifiers
 Portable Phones
 Sensor Interface
 Active Filters
 PCMCIA Cards
 ASIC Input Drivers
 Wearable Computers
 Battery Powered Devices
 Voltage Reference Buffers
 Personal Digital Assistants

GENERAL DESCRIPTION

The AD8519 and AD8529 are rail-to-rail output bipolar amplifiers with a unity gain bandwidth of 8 MHz and a typical voltage offset of less than 1 mV. The AD8519 brings precision and bandwidth to the SOT-23 package. The low supply current makes the AD8519/AD8529 ideal for battery powered applications. The rail-to-rail output swing of the AD8519/AD8529 is larger than standard video op amps, making them useful in applications that require greater dynamic range than standard video op amps. The +2.7 V/ μ s slew rate makes the AD8529/AD8549 a good match for driving ASIC inputs such as voice codecs.

The small SOT-23 package makes it possible to place the AD8519 next to sensors, reducing external noise pickup.

The AD8519/AD8529 is specified over the extended industrial (-40°C to +125°C) temperature range. The AD8519 is available in 5-lead SOT-23-5 and SO-8 surface mount packages. The AD8529 is available in 8-lead SOIC and μ SOIC packages.

PIN CONFIGURATIONS

8-Lead SOIC (R Suffix)

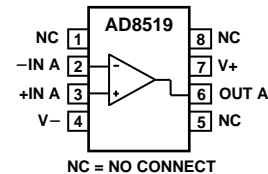

5-Lead SOT-23 (RT Suffix)

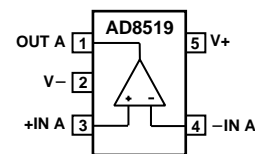

8-Lead SOIC (R Suffix)

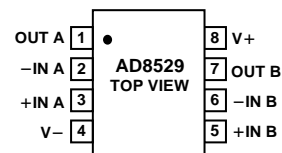

8-Lead μ SOIC (RM Suffix)

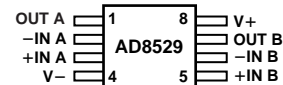

REV. A

Information furnished by Analog Devices is believed to be accurate and reliable. However, no responsibility is assumed by Analog Devices for its use, nor for any infringements of patents or other rights of third parties which may result from its use. No license is granted by implication or otherwise under any patent or patent rights of Analog Devices.

AD8519/AD8529—SPECIFICATIONS

ELECTRICAL CHARACTERISTICS ($V_S = +5.0\text{ V}$, $V_- = 0\text{ V}$, $V_{CM} = +2.5\text{ V}$, $T_A = +25^\circ\text{C}$ unless otherwise noted)

Parameter	Symbol	Conditions	Min	Typ	Max	Units
INPUT CHARACTERISTICS						
Offset Voltage	V_{OS}	AD8519ART (SOT-23-5) $-40^\circ\text{C} \leq T_A \leq +125^\circ\text{C}$		600	1,100	μV
Offset Voltage	V_{OS}	AD8519AR (SO-8), AD8529 $-40^\circ\text{C} \leq T_A \leq +125^\circ\text{C}$		800	1,300	μV
Input Bias Current	I_B				1,100	μV
Input Offset Current	I_{OS}	$-40^\circ\text{C} \leq T_A \leq +125^\circ\text{C}$			300	nA
Input Voltage Range	V_{CM}				400	nA
Common-Mode Rejection Ratio	CMRR	$-40^\circ\text{C} \leq T_A \leq +125^\circ\text{C}$			± 50	nA
Large Signal Voltage Gain	A_{VO}	$0\text{ V} \leq V_{CM} \leq +4.0\text{ V}$, $-40^\circ\text{C} \leq T_A \leq +125^\circ\text{C}$	0		± 100	V
Offset Voltage Drift	$\Delta V_{OS}/\Delta T$	$0\text{ V} \leq V_{CM} \leq +4.0\text{ V}$, $-40^\circ\text{C} \leq T_A \leq +125^\circ\text{C}$	63	100		dB
Bias Current Drift	$\Delta I_B/\Delta T$	$R_L = 2\text{ k}\Omega$, $+0.5\text{ V} < V_{OUT} < +4.5\text{ V}$ $R_L = 10\text{ k}\Omega$, $+0.5\text{ V} < V_{OUT} < +4.5\text{ V}$ $R_L = 10\text{ k}\Omega$, $-40^\circ\text{C} \leq T_A \leq +125^\circ\text{C}$	50	100		V/mV
			30			V/mV
				2		$\mu\text{V}/^\circ\text{C}$
				500		$\text{pA}/^\circ\text{C}$
OUTPUT CHARACTERISTICS						
Output Voltage Swing High	V_{OH}	$I_L = 250\text{ }\mu\text{A}$ $-40^\circ\text{C} \leq T_A \leq +125^\circ\text{C}$	+4.90			V
Output Voltage Swing Low	V_{OL}	$I_L = 5\text{ mA}$ $I_L = 250\text{ }\mu\text{A}$ $-40^\circ\text{C} \leq T_A \leq +125^\circ\text{C}$	+4.80			V
Short Circuit Current	I_{SC}	$I_L = 5\text{ mA}$			80	mV
Maximum Output Current	I_{OUT}	Short to Ground, Instantaneous		± 70	200	mV
				± 25		mA
POWER SUPPLY						
Power Supply Rejection Ratio	PSRR	$V_S = +2.7\text{ V}$ to $+7\text{ V}$, $-40^\circ\text{C} \leq T_A \leq +125^\circ\text{C}$		110		dB
Supply Current/Amplifier	I_{SY}	$V_{OUT} = +2.5\text{ V}$ $-40^\circ\text{C} \leq T_A \leq +125^\circ\text{C}$		80		dB
				600	1,200	μA
					1,400	μA
DYNAMIC PERFORMANCE						
Slew Rate	SR	$+1\text{ V} < V_{OUT} < +4\text{ V}$, $R_L = 10\text{ k}\Omega$		2.9		V/ μs
Settling Time	t_s	To 0.01%		1,200		ns
Gain Bandwidth Product	GBP			8		MHz
Phase Margin	ϕ_m			60		Degrees
NOISE PERFORMANCE						
Voltage Noise	e_n p-p	0.1 Hz to 10 Hz		0.5		$\mu\text{V p-p}$
Voltage Noise Density	e_n	$f = 1\text{ kHz}$		7		$\text{nV}/\sqrt{\text{Hz}}$
Current Noise Density	i_n	$f = 1\text{ kHz}$		0.4		$\text{pA}/\sqrt{\text{Hz}}$

Specifications subject to change without notice.

ELECTRICAL CHARACTERISTICS ($V_S = +3.0\text{ V}$, $V_- = 0\text{ V}$, $V_{CM} = +1.5\text{ V}$, $T_A = +25^\circ\text{C}$ unless otherwise noted)

Parameter	Symbol	Conditions	Min	Typ	Max	Units
INPUT CHARACTERISTICS						
Offset Voltage	V_{OS}	AD8519ART (SOT-23-5) $-40^\circ\text{C} \leq T_A \leq +125^\circ\text{C}$		700	1,200	μV
	V_{OS}	AD8519AR (SO-8), AD8529 $-40^\circ\text{C} \leq T_A \leq +125^\circ\text{C}$		900	1,400	μV
Input Bias Current	I_B				300	nA
Input Offset Current	I_{OS}				± 50	nA
Input Voltage Range	V_{CM}		0		+2	V
Common-Mode Rejection Ratio	CMRR	$0\text{ V} \leq V_{CM} \leq +2.0\text{ V}$, $-40^\circ\text{C} \leq T_A \leq +125^\circ\text{C}$	55	75		dB
Large Signal Voltage Gain	A_{VO}	$R_L = 2\text{ k}\Omega$, $+0.5\text{ V} < V_{OUT} < +2.5\text{ V}$ $R_L = 10\text{ k}\Omega$		20	30	V/mV
						V/mV
OUTPUT CHARACTERISTICS						
Output Voltage Swing High	V_{OH}	$I_L = 250\text{ }\mu\text{A}$ $I_L = 5\text{ mA}$	+2.90			V
Output Voltage Swing Low	V_{OL}	$I_L = 250\text{ }\mu\text{A}$ $I_L = 5\text{ mA}$	+2.80			V
					100	mV
					200	mV
POWER SUPPLY						
Power Supply Rejection Ratio	PSRR	$V_S = +2.5\text{ V to } +7\text{ V}$, $-40^\circ\text{C} \leq T_A \leq +125^\circ\text{C}$	60	80		dB
Supply Current/Amplifier	I_{SY}	$V_{OUT} = +1.5\text{ V}$ $-40^\circ\text{C} \leq T_A \leq +125^\circ\text{C}$		600	1,100	μA
					1,300	μA
DYNAMIC PERFORMANCE						
Slew Rate	SR	$R_L = 10\text{ k}\Omega$		1.5		V/ μs
Settling Time	t_S	$T_O 0.01\%$		2,000		ns
Gain Bandwidth Product	GBP			6		MHz
Phase Margin	ϕ_m			55		Degrees
NOISE PERFORMANCE						
Voltage Noise Density	e_n	$f = 1\text{ kHz}$		10		$\text{nV}/\sqrt{\text{Hz}}$
Current Noise Density	i_n	$f = 1\text{ kHz}$		0.4		$\text{pA}/\sqrt{\text{Hz}}$

Specifications subject to change without notice.

AD8519/AD8529—SPECIFICATIONS

ELECTRICAL CHARACTERISTICS ($V_S = +2.7\text{ V}$, $V_- = 0\text{ V}$, $V_{CM} = +1.35\text{ V}$, $T_A = +25^\circ\text{C}$ unless otherwise noted)

Parameter	Symbol	Conditions	Min	Typ	Max	Units
INPUT CHARACTERISTICS						
Offset Voltage	V_{OS}	AD8519ART (SOT-23-5) $-40^\circ\text{C} \leq T_A \leq +125^\circ\text{C}$		700	1,400	μV
	V_{OS}	AD8519AR (SO-8), AD8529 $-40^\circ\text{C} \leq T_A \leq +125^\circ\text{C}$		900	1,600	μV
Input Bias Current	I_B				1,200	μV
Input Offset Current	I_{OS}				1,300	μV
Input Voltage Range	V_{CM}		0		+2	V
Common-Mode Rejection Ratio	CMRR	$0\text{ V} \leq V_{CM} \leq +1.7\text{ V}$, $-40^\circ\text{C} \leq T_A \leq +125^\circ\text{C}$				
Large Signal Voltage Gain	A_{VO}	$R_L = 2\text{ k}\Omega$, $+0.5\text{ V} < V_{OUT} < +2.2\text{ V}$ $R_L = 10\text{ k}\Omega$	55	75		dB
			20	30		V/mV
OUTPUT CHARACTERISTICS						
Output Voltage Swing High	V_{OH}	$I_L = 250\text{ }\mu\text{A}$ $I_L = 5\text{ mA}$	+2.60			V
Output Voltage Swing Low	V_{OL}	$I_L = 250\text{ }\mu\text{A}$ $I_L = 5\text{ mA}$	+2.50			V
					100	mV
					200	mV
POWER SUPPLY						
Power Supply Rejection Ratio	PSRR	$V_S = +2.5\text{ V to } +7\text{ V}$, $-40^\circ\text{C} \leq T_A \leq +125^\circ\text{C}$	60	80		dB
Supply Current/Amplifier	I_{SY}	$V_{OUT} = +1.35\text{ V}$ $-40^\circ\text{C} \leq T_A \leq +125^\circ\text{C}$		600	1,100	μA
					1,300	μA
DYNAMIC PERFORMANCE						
Slew Rate	SR	$R_L = 10\text{ k}\Omega$		1.5		V/ μs
Settling Time	t_S	$T_O = 0.01\%$		2,000		ns
Gain Bandwidth Product	GBP			6		MHz
Phase Margin	ϕ_m			55		Degrees
NOISE PERFORMANCE						
Voltage Noise Density	e_n	$f = 1\text{ kHz}$		10		$\text{nV}/\sqrt{\text{Hz}}$
Current Noise Density	i_n	$f = 1\text{ kHz}$		0.4		$\text{pA}/\sqrt{\text{Hz}}$

Specifications subject to change without notice.

ELECTRICAL CHARACTERISTICS ($V_S = +5.0\text{ V}$, $V_- = -5\text{ V}$, $V_{CM} = 0\text{ V}$, $T_A = +25^\circ\text{C}$ unless otherwise noted)

Parameter	Symbol	Conditions	Min	Typ	Max	Units
INPUT CHARACTERISTICS						
Offset Voltage	V_{OS}	AD8519ART (SOT-23-5) $-40^\circ\text{C} \leq T_A \leq +125^\circ\text{C}$		600	1,100	μV
	V_{OS}	AD8519AR (SO-8), AD8529 $-40^\circ\text{C} \leq T_A \leq +125^\circ\text{C}$		800	1,300	μV
Input Bias Current	I_B	$V_{CM} = 0\text{ V}$			300	nA
		$V_{CM} = 0\text{ V}$, $-40^\circ\text{C} \leq T_A \leq +125^\circ\text{C}$			400	nA
Input Offset Current	I_{OS}	$V_{CM} = 0\text{ V}$ $V_{CM} = 0\text{ V}$, $-40^\circ\text{C} \leq T_A \leq +125^\circ\text{C}$			± 50 ± 100	nA nA
Input Voltage Range	V_{CM}		-5		+4	V
Common-Mode Rejection Ratio	CMRR	$-4.9\text{ V} \leq V_{CM} \leq +4.0\text{ V}$, $-40^\circ\text{C} \leq T_A \leq +125^\circ\text{C}$	70	100		dB
Large Signal Voltage Gain	A_{VO}	$R_L = 2\text{ k}\Omega$		30		V/mV
		$R_L = 10\text{ k}\Omega$	50	200		V/mV
		$-40^\circ\text{C} \leq T_A \leq +125^\circ\text{C}$	25			V/mV
Offset Voltage Drift	$\Delta V_{OS}/\Delta T$			2		$\mu\text{V}/^\circ\text{C}$
Bias Current Drift	$\Delta I_B/\Delta T$			500		$\text{pA}/^\circ\text{C}$
OUTPUT CHARACTERISTICS						
Output Voltage Swing High	V_{OH}	$I_L = 250\text{ }\mu\text{A}$ $-40^\circ\text{C} \leq T_A \leq +125^\circ\text{C}$	+4.90			V
Output Voltage Swing Low	V_{OL}	$I_L = 5\text{ mA}$	+4.80			V
		$I_L = 250\text{ }\mu\text{A}$ $-40^\circ\text{C} \leq T_A \leq +125^\circ\text{C}$			-4.90	V
Short Circuit Current	I_{SC}	$I_L = 5\text{ mA}$ Short to Ground, Instantaneous		± 70		mA
Maximum Output Current	I_{OUT}			± 25		mA
POWER SUPPLY						
Power Supply Rejection Ratio	PSRR	$V_S = \pm 1.5\text{ V}$ to $\pm 6\text{ V}$, $-40^\circ\text{C} \leq T_A \leq +125^\circ\text{C}$	60	100		dB
Supply Current/Amplifier	I_{SY}	$V_{OUT} = 0\text{ V}$ $-40^\circ\text{C} \leq T_A \leq +125^\circ\text{C}$		600	1,200 1,400	μA μA
DYNAMIC PERFORMANCE						
Slew Rate	SR	$-4\text{ V} < V_{OUT} < +4\text{ V}$, $R_L = 10\text{ k}\Omega$		2.9		V/ μs
Settling Time	t_s	To 0.01%		1,000		ns
Gain Bandwidth Product	GBP			8		MHz
Phase Margin	ϕ_m			60		Degrees
NOISE PERFORMANCE						
Voltage Noise Density	e_n	$f = 1\text{ kHz}$		7		$\text{nV}/\sqrt{\text{Hz}}$
Current Noise Density	i_n	$f = 1\text{ kHz}$		0.4		$\text{pA}/\sqrt{\text{Hz}}$

Specifications subject to change without notice.

AD8519/AD8529

ABSOLUTE MAXIMUM RATINGS¹

Supply Voltage	±6 V
Input Voltage ²	±6 V
Differential Input Voltage ³	±0.6 V
Internal Power Dissipation	
SOT-23 (RT)	Observe Derating Curve
SOIC (R)	Observe Derating Curve
μSOIC (RM)	Observe Derating Curve
Output Short-Circuit Duration	Observe Derating Curve
Storage Temperature Range	
RT, S Packages	-65°C to +150°C
Operating Temperature Range	
AD8519, AD8529	-40°C to +125°C
Junction Temperature Range	
RT, S Packages	-65°C to +150°C
Lead Temperature Range (Soldering, 60 sec)	+300°C

NOTES

¹Stresses above those listed under Absolute Maximum Ratings may cause permanent damage to the device. This is a stress rating only; functional operation of the device at these or any other conditions above those listed in the operational sections of this specification is not implied. Exposure to absolute maximum rating conditions for extended periods may affect device reliability.

²For supply voltages less than ±6 V the input voltage is limited to less than or equal to the supply voltage.

³For differential input voltages greater than ±0.6 V the input current should be limited to less than 5 mA to prevent degradation or destruction of the input devices.

CAUTION

ESD (electrostatic discharge) sensitive device. Electrostatic charges as high as 4000 V readily accumulate on the human body and test equipment and can discharge without detection. Although the AD8519/AD8529 features proprietary ESD protection circuitry, permanent damage may occur on devices subjected to high energy electrostatic discharges. Therefore, proper ESD precautions are recommended to avoid performance degradation or loss of functionality.

Package Type	θ_{JA} ¹	θ_{JC}	Units
5-Lead SOT-23 (RT)	230	146	°C/W
8-Lead SOIC (R)	158	43	°C/W
8-Lead μSOIC (RM)	210	45	°C/W

NOTE

¹ θ_{JA} is specified for worst case conditions, i.e., θ_{JA} is specified for device soldered in circuit board for SOT-23 and SOIC packages.

ORDERING GUIDE

Model	Temperature Range	Package Description	Package Option
AD8519ART ¹	-40°C to +125°C	5-Lead SOT-23	RT-5
AD8519AR	-40°C to +125°C	8-Lead SOIC	SO-8
AD8529AR	-40°C to +125°C	8-Lead SOIC	SO-8
AD8529ARM ²	-40°C to +125°C	8-Lead μSOIC	RM-8

NOTES

¹Available in 3,000 piece reels only.

²Available in 2,500 piece reels only.



Typical Characteristics – AD8519/AD8529

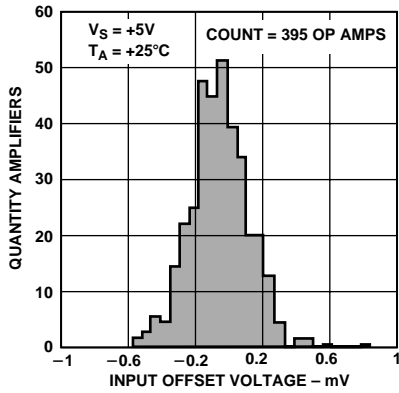

Figure 1. Input Offset Voltage Distribution

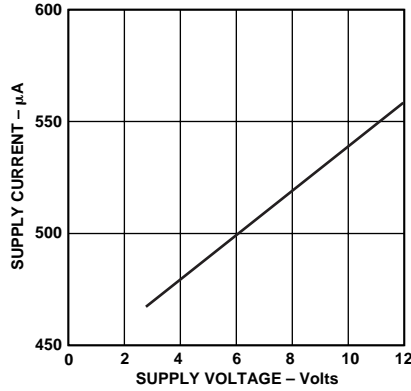

Figure 2. Supply Current per Amplifier vs. Supply Voltage

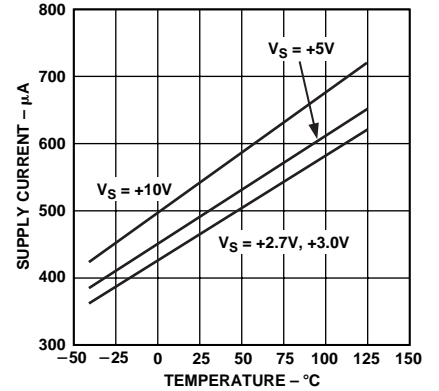

Figure 3. Supply Current per Amplifier vs. Temperature

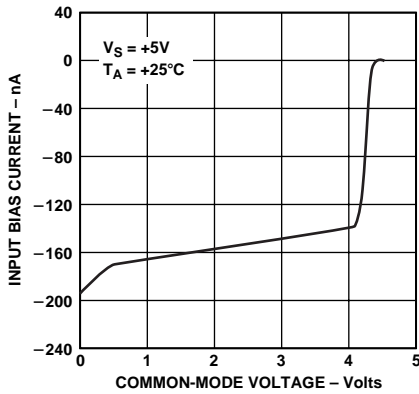

Figure 4. Input Bias Current vs. Common-Mode Voltage

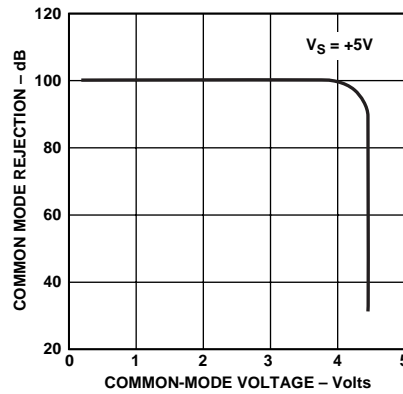

Figure 5. Common-Mode Rejection vs. Common-Mode Voltage

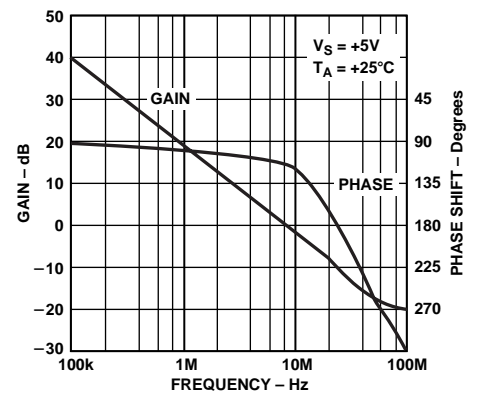

Figure 6. Open Loop Gain, Phase vs. Frequency

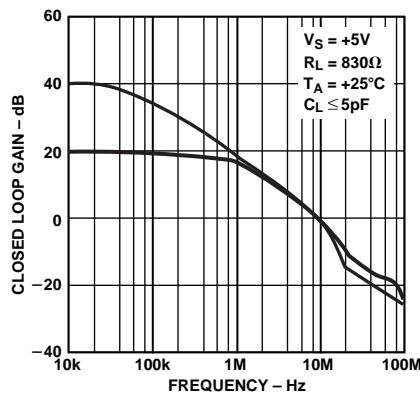

Figure 7. Closed Loop Gain vs. Frequency

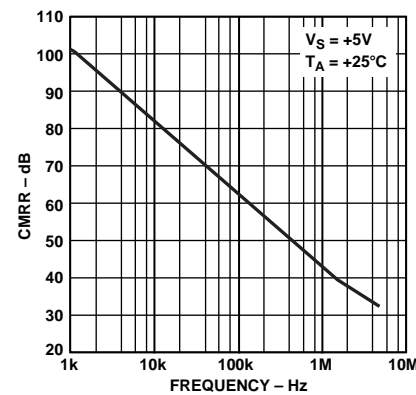

Figure 8. CMRR vs. Frequency

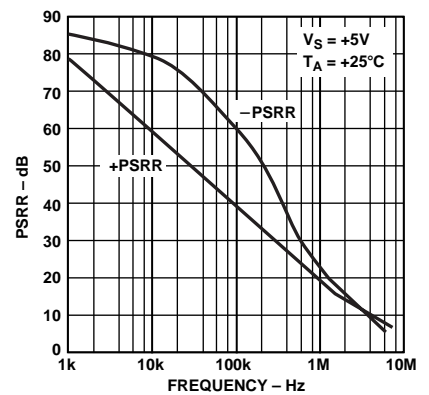

Figure 9. PSRR vs. Frequency

AD8519/AD8529

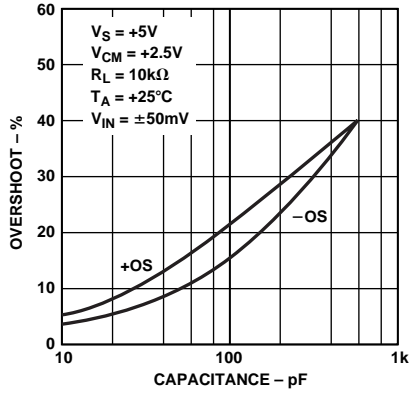

Figure 10. Overshoot vs. Capacitance Load

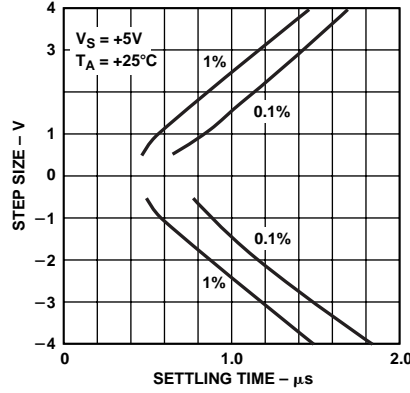

Figure 11. Settling Time vs. Step Size

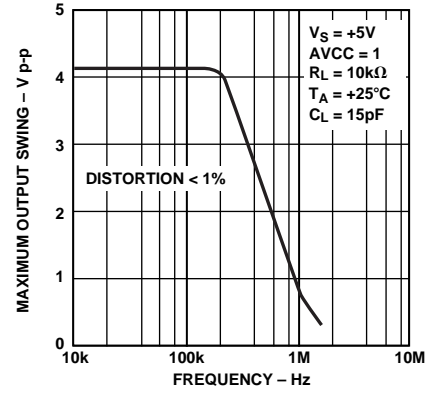

Figure 12. Output Swing vs. Frequency

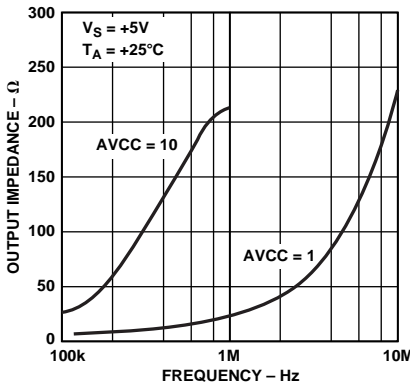

Figure 13. Output Impedance vs. Frequency

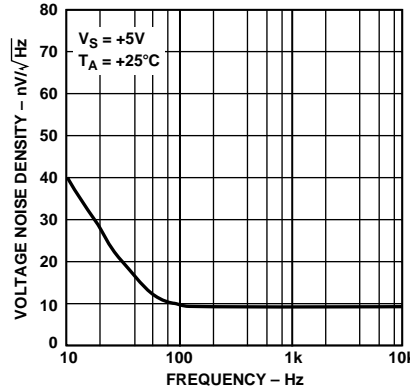

Figure 14. AD8519 Voltage Noise Density

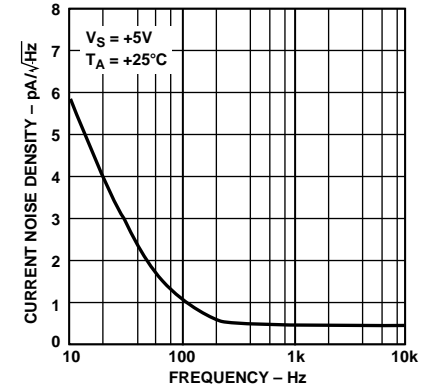

Figure 15. AD8519 Current Noise Density

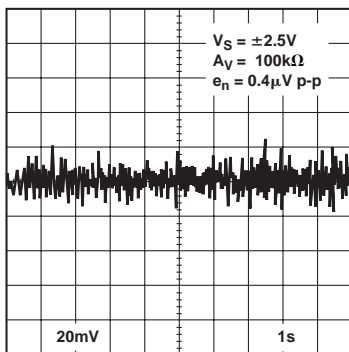

Figure 16. 0.1 Hz to 10 Hz Noise

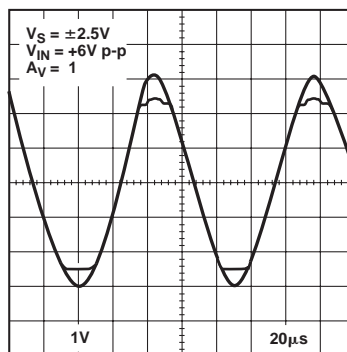

Figure 17. No Phase Reversal

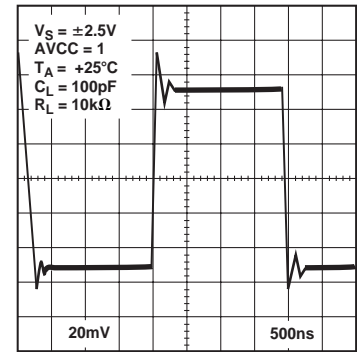

Figure 18. Small Signal Transient Response

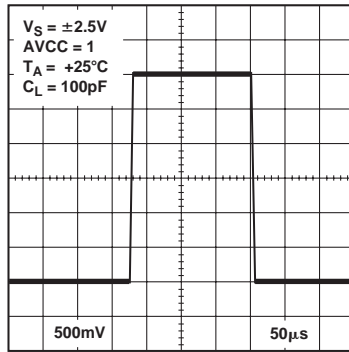

Figure 19. Large Signal Transient Response

APPLICATIONS INFORMATION

Maximum Power Dissipation

The maximum power that can be safely dissipated by the AD8519/AD8529 is limited by the associated rise in junction temperature. The maximum safe junction temperature is +150°C for these plastic packages. If this maximum is momentarily exceeded, proper circuit operation will be restored as soon as the die temperature is reduced. Operating the product in the “overheated” condition for an extended period can result in permanent damage to the device.

Precision Full-Wave Rectifier

Slew Rate is probably the most underestimated parameter when designing a precision rectifier. Yet without a good slew rate large glitches will be generated during the period when both diodes are off.

Let’s examine the operation of the basic circuit before considering slew rate further, U1 is set up to have two states of operation. D1 and D2 diodes switch the output between the two states. State one is as an inverter with a gain of 1 and state two is a simple unity gain buffer where the output is equal to the value of the virtual ground. The virtual ground is the potential present at the noninverting node of the U1. State one is active when V_{IN} is larger than the virtual ground. D2 is on in this condition. If V_{IN} drops below virtual ground, D2 turns off and D1 turns on. This causes the output of U1 to simply buffer the virtual ground and this configuration is state two. So, the function of U1, which results from these two states of operation, is a half-wave inverter. The U2 function takes the inverted half-wave at a gain of two and sums it into the original V_{IN} wave, which outputs a rectified full-wave.

$$V_{OUT} = V_{IN} - 2 \left| V_{IN}^{-1} < 0 \right|$$

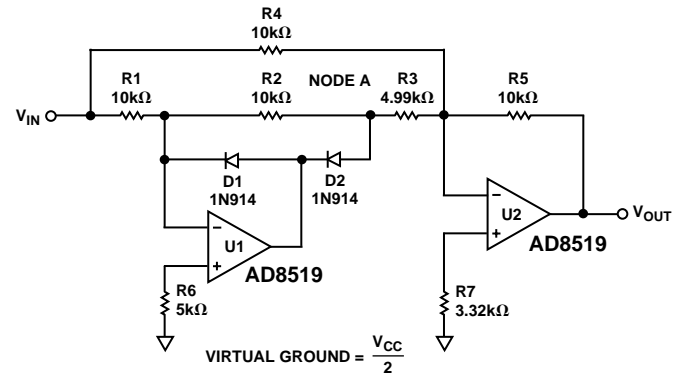

Figure 20. Precision Full-Wave Rectifier

This type of rectifier can be very precise if the following electrical parameters are adhered to: First, all passive components should be of tight tolerance, 1% resistors and 5% capacitors. Second, if the application circuit requires high impedance (i.e., direct sensor interface), then an FET amplifier is probably a better choice than the AD8519. Third, an amp such as the AD8519, which has a great slew rate specification, will yield the best result, because the circuit involves switching. Switching glitches are caused when D1 and D2 are both momentarily off. This condition occurs every time the input signal is equal to the virtual ground potential. When this condition occurs the U1 stage is taken out of the V_{OUT} equation and V_{OUT} is equal to $V_{IN} \times R5 \times (R4 \parallel R1 + R2 + R3)$. Please note: node A should be V_{IN} inverted or virtual ground, but in this condition node A is a simply tracking V_{IN} . Given a sine wave input centered around virtual ground glitches are generated at the sharp negative peaks of the rectified sine wave. If the glitches are hard to notice on an oscilloscope, then raise the frequency of the sine wave till they become apparent. The size of the glitches are proportional to the input frequency, the diode turn-on potential (+0.2 V or +0.65 V) and the slew rate of the op amp.

R6 and R7 are both necessary to limit the amount of bias current related voltage offset. Unfortunately, there is no “perfect” value for R6 because the impedance at the inverting node is altered as D1 and D2 switch. Therefore, there will also be some unresolved bias current related offset. To minimize this offset, use lower value resistors or choose an FET amplifier if the optimized offset is still intolerable.

The AD8519 offers a unique combination of speed vs. power ratio at +2.7 V single supply, small size (SOT-23), and low noise that make it an ideal choice for most high volume and high precision rectifier circuits.

10× Microphone Preamp, Meets PC99 Specifications

This circuit, while lacking a unique topology, is anything but featureless when an AD8519 is used as the op amp. This preamp gives 20 dB gain over a frequency range of 20 Hz to 20 kHz and is fully PC99 compliant in all parameters including THD+N, dynamic range, frequency range, amplitude range, crosstalk, etc. Not only does this preamp comply with the PC99 spec it far surpasses it. In fact, this preamp has a V_{OUT} noise of around 100 dB, which is suitable for most professional 20-bit audio systems. Referred to input noise is 120 dB. At 120 dB THD+N in unity gain the AD8519 is suitable for all 24-bit professional audio systems available today. In other words, the AD8519 will not be the limiting performance factor in your audio system despite its small size and low cost.

AD8519/AD8529

Slew-rate-related distortion would not be present at the lower voltages because the AD8519 is so fast at 2.1 V/ μ s. A general rule of thumb for determining the necessary slew rate for an audio system is: Take the maximum output voltage range of the device given the design's power rails and divide by two. In our example in Figure 21, the power rails are +2.7 V and the output is rail-to-rail: enter those numbers into the equation $2.7/2$ is +1.35 V, and our minimum ideal slew rate is 1.35 V/ μ s.

While this data sheet gives only one audio example, many audio circuits are enhanced with the use of the AD8519. Here are just a few examples, Active audio filters like bass, treble and equalizers, PWM filters at the output of audio DACs, Buffers and Summers for mixing stations, and Gain stages for volume control.

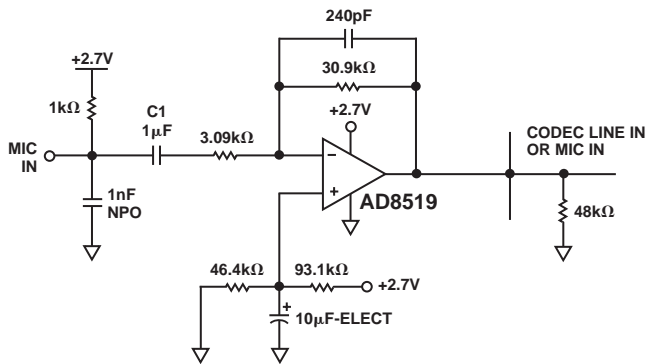

Figure 21. 10× Microphone Preamplifier

Two-Element Varying Bridge Amplifier

There are a host of bridge configurations available to designers. For a complete look the ubiquitous bridge, its positives and negatives, and its many different forms, please refer to ADI's 1992 Amplifier Applications Guide¹.

1. Adolfo Garcia and James Wong, Chapter 2, 1992 Amplifier Applications Guide.

Figure 22 is a schematic of a two-element varying bridge. This configuration is commonly found in pressure and flow transducers. With two-elements varying the signal will be 2× as compared to a single-element varying bridge. The advantages of this type of bridge are gain setting range, no signal input equals 0 V out, and single supply application. Negative characteristics are nonlinear operation and required R matching. Given these sets of conditions, requirements and characteristics, the AD8519 can be successfully used in this configuration because of its rail-to-rail output and low offset. Perhaps the greatest benefits of the AD8519, when used in the bridge configuration, are the advantages it can bring when placed in a remote bridge sensor. For example: the tiny SOT-23 package will reduce the overall sensor package, low power allows for remote powering via batteries or solar cells, high output current drive to drive a long cable, and +2.7 V operation for two cell operation.

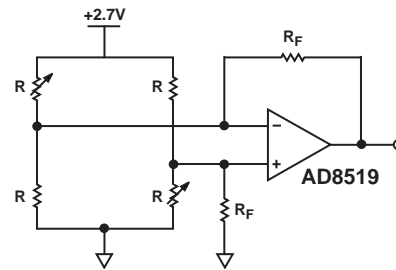
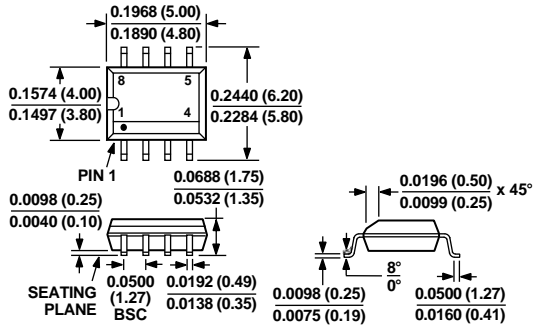

Figure 22. Two-Element Varying Bridge Amplifier

OUTLINE DIMENSIONS

Dimensions shown in inches and (mm).

8-Lead Narrow Body SOIC (SO-8)



8-Lead μ SOIC (RM-8)

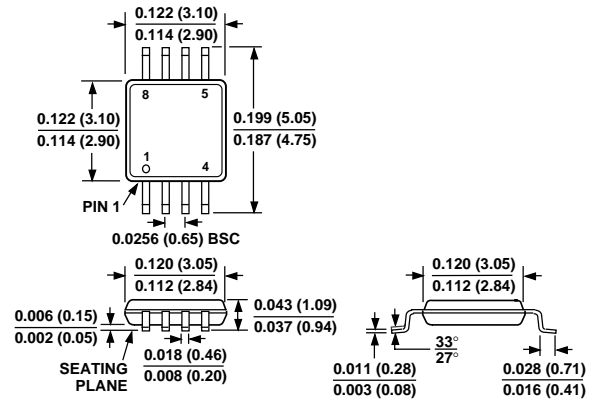

5-Lead SOT-23 (RT-5)

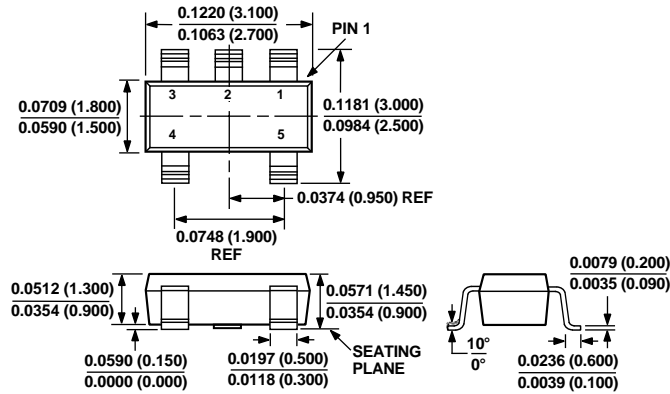

NOTE:
PACKAGE OUTLINE INCLUSIVE AS SOLDER PLATING.